

Ultra Low Noise, High IP3 Monolithic Amplifier Die

PMA2-162LN-D+

50Ω 0.7 to 1.6 GHz

The Big Deal

- Ultra Low Noise Figure, 0.5 dB
- High Gain, High IP3
- Adjustable Gain

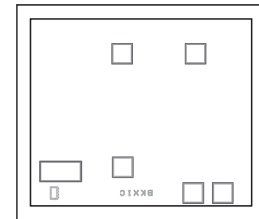

Product Overview

Mini-Circuits PMA2-162LN-D+ is a E-PHEMT based Ultra-Low Noise MMIC Amplifier Die with a unique combinations of low noise and high IP3 making this amplifier ideal for sensitive high dynamic range receiver applications. This design operates on a single 4V supply.

Key Features

Feature	Advantages
Ultra Low Noise, 0.5 dB at 1.0 GHz	Outstanding world class noise figure performance.
High IP3, +30 dBm at 1.0 GHz	Combining Low Noise and High IP3 makes this MMIC amplifier ideal for use in Low Noise Receiver Front End (RFE) as it gives the user advantages at both ends of the dynamic range: sensitivity & two-tone IM performance.
Adjustable Gain	By changing feedback resistor R1, gain can be changed from 19.7 to 23.5 dB at 1GHz
Max Input Power, +25 dBm	Ruggedized design operates up to high input powers often seen at Receiver inputs eliminating the need for an external resistor.
High Reliability	Low, small signal operating current of 55 mA nominal maintains junction temperatures typically below 100°C at 85°C ground lead temperature.
Unpackage Die	Enables direct integration into customer hybrids.



Ultra Low Noise, High IP3 Monolithic Amplifier Die

PMA2-162LN-D+

50Ω 0.7 to 1.6 GHz

Product Features

- Low Noise figure, 0.5 at 1 GHz
- High IP3, 30 dBm typ. at 1 GHz
- Adjustable Gain, 19.7-23.5 dB typ. at 1 GHz
- High Pout, P1dB 20 dBm typ. at 1 GHz

Typical Applications

- Base station infrastructure
- Portable Wireless
- LTE
- GPS
- GSM
- Airborne radar

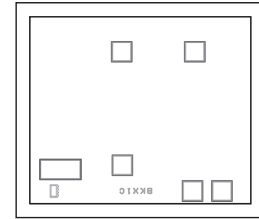

+RoHS Compliant
The +Suffix identifies RoHS Compliance. See our web site for RoHS Compliance methodologies and qualifications

Ordering Information: Refer to Last Page

General Description

PMA2-162LN-D+ (RoHS compliant) is an amplifier Die fabricated using E-PHEMT technology and offers extremely high dynamic range with ultra low noise figure and good input and output return loss.

Simplified Schematic and Pad description

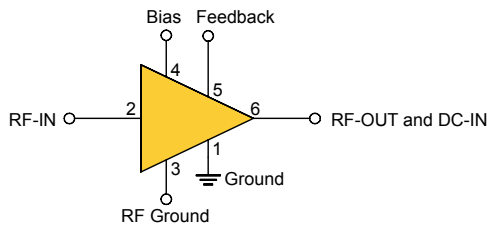

Pad#	Function	Description
2	RF-IN	Connects to RF input via C1 and Pad 3 via L1
6	RF-OUT & DC-IN	Connects to RF out via C2, Pad 5 via R1, and C3
3	RF-Ground	Connects to ground via C4 and Pad 2 via L1
4	Bias	Connects to Supply voltage (Vs) via Rbias
5	Feedback	Connected to pads 6, 4 via R1 and C3
1	Ground	Connects to ground
Die Bottom	Ground	Connects to ground

Note: 1. Bond Pad material - Gold
2. Bottom of Die - Gold plated

Bonding Pad Position

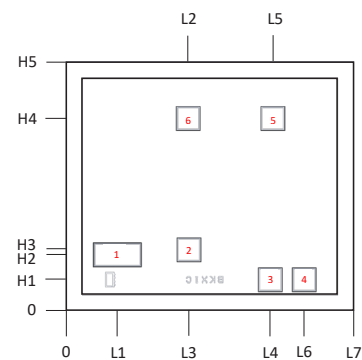

Dimensions in μm, Typical

L1	L2	L3	L4	L5	L6	L7	H1	H2	H3	H4	H5	Thickness	Die Size	Bond pad #1 size	Bond pad size #2 to #6
159	378	380	631	639	736	890	98	174	190	595	770	100	890 X 770	140 x 65	65 x 65

Electrical Specifications^{1,2} at 25°C and 4V, unless noted

Parameter	Condition (GHz)	R1=267Ω ¹			R1=93Ω ²			Units
		Min.	Typ.	Max.	Min.	Typ.	Max.	
Frequency Range		0.7		1.6	0.7		1.6	GHz
Noise Figure	0.7		0.55			0.57		dB
	0.8		0.51			0.54		
	1.0		0.47			0.48		
	1.3		0.64			0.65		
	1.6		0.80			0.81		
Gain	0.7		24.4			22.7		dB
	0.8		24.1			22.2		
	1.0		22.7			20.8		
	1.3		20.7			19.1		
	1.6		18.8			17.7		
Input Return Loss	0.7		9.5			11.5		dB
	0.8		15.5			18.8		
	1.0		17.9			20.0		
	1.3		12.4			14.5		
	1.6		10.8			12.4		
Output Return Loss	0.7		13.6			21.6		dB
	0.8		16.1			17.8		
	1.0		18.9			16.0		
	1.3		15.6			15.1		
	1.6		10.7			11.6		
Output Power @ 1 dB compression ³	0.7		19.5			18.3		dBm
	0.8		19.8			18.9		
	1.0		19.9			19.7		
	1.3		19.7			19.8		
	1.6		18.8			19.0		
Output IP3	0.7		29.1			28.3		dBm
	0.8		30.3			29.5		
	1.0		30.0			29.0		
	1.3		30.1			29.2		
	1.6		29.4			28.5		
Device Operating Voltage		3.8	4.0	4.2	3.8	4.0	4.2	V
Device Operating Current at 4V			55	60		55	60	mA
Device Current Variation vs. Temperature at 4V ⁴			2			2		μA/°C
Device Current Variation vs Voltage at 25°C			0.016			0.016		mA/mV
Thermal Resistance, junction-to-ground lead			53			53		°C/W

1. Measured on Mini-Circuits Characterization test board. Die package in 2x2 mm, 8-lead MCLP package and soldered on TB-615+. See Characterization Test Circuit (Fig. 1) R1=267Ω
 2. Measured on Mini-Circuits Characterization test board. See Characterization Test Circuit (Fig. 1) R1=93Ω
 3. Current increases at P1dB
 4. (Current at 85°C - Current at -45°C)/130

Absolute Maximum Ratings

Parameter	Ratings
Operating Temperature (ground lead)	-40°C to 85°C
Junction Temperature	150°C
Total Power Dissipation	0.55 W
Input Power (CW), Vd=4V	25 dBm
DC Voltage	5.5V

Note:
 Permanent damage may occur if any of these limits are exceeded.
 Electrical maximum ratings are not intended for continuous normal operation.

Recommended Application and Characterization Test Circuit

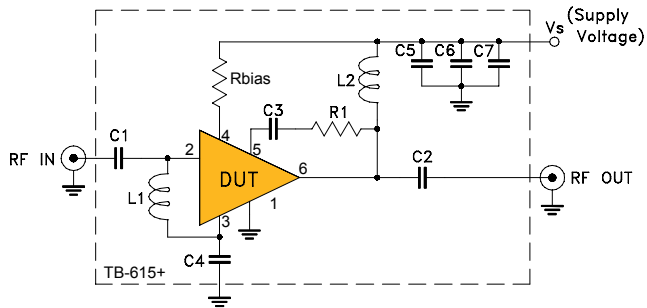

Fig 1. Application and Characterization circuit

Note: This block diagram is used for characterization.

Gain, Return loss, Output power at 1dB compression (P1 dB) , output IP3 (OIP3) and noise figure measured using Agilent's N5242A PNA-X microwave network analyzer.

Conditions:

1. (DUT packaged in 2x2mm, 8-lead MCLP package and soldered on Mini-Circuits Characterization test board TB-615+)
2. Gain and Return loss: Pin= -25dBm
3. Output IP3 (OIP3): Two tones, spaced 1 MHz apart, 0 dBm/tone at output.

Adjustable Gain Performance (vs. R1)¹

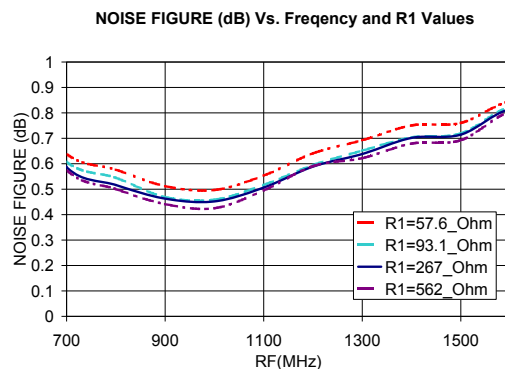
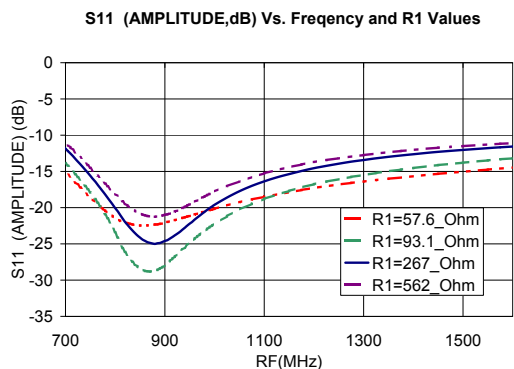
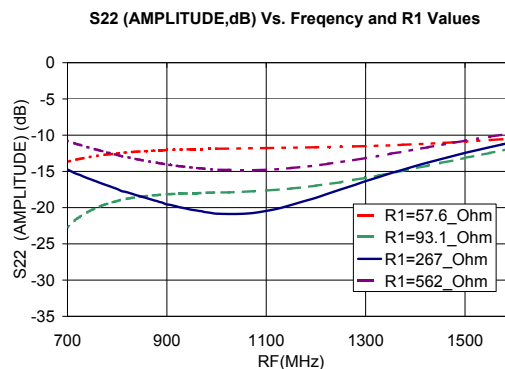
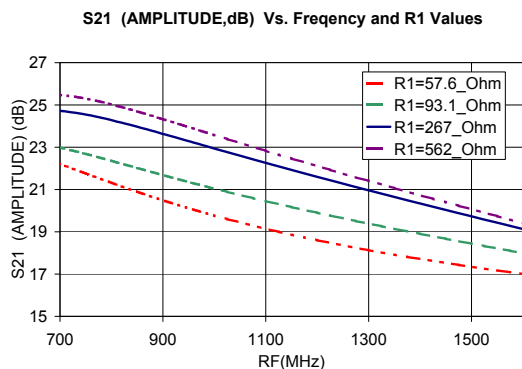

Assembly Diagram

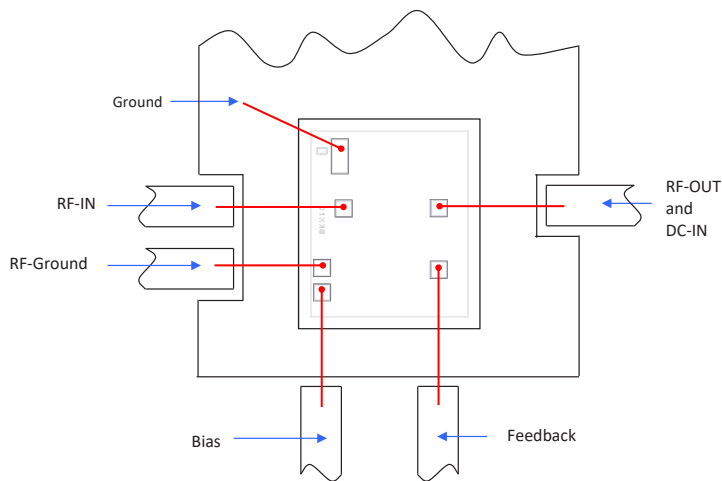

Assembly and Handling Procedure

1. Storage
Dice should be stored in a dry nitrogen purged desiccators or equivalent.
2. ESD
MMIC E-PHEMT amplifier dice are susceptible to electrostatic and mechanical damage. Die are supplied in antistatic protected material, which should be opened in clean room conditions at an appropriately grounded anti-static workstation. Devices need careful handling using correctly designed collets, vacuum pickup tips or sharp antistatic tweezers to deter ESD damage to dice.
3. Die Attach
The die mounting surface must be clean and flat. Using conductive silver filled epoxy, recommended epoxies are DieMat DM6030HK-PT/H579 or Ablestik 84-1LMISR4. Apply sufficient epoxy to meet required epoxy bond line thickness, epoxy fillet height and epoxy coverage around total die periphery. Parts shall be cured in a nitrogen filled atmosphere per manufacturer's cure condition. It is recommended to use antistatic die pick up tools only.
4. Wire Bonding
Bond pad openings in the surface passivation above the bond pads are provided to allow wire bonding to the dice gold bond pads. Thermosonic bonding is used with minimized ultrasonic content. Bond force, time, ultrasonic power and temperature are all critical parameters. Suggested wire is pure gold, 1 mil diameter. Bonds must be made from the bond pads on the die to the package or substrate. All bond wires should be kept as short as low as reasonable to minimize performance degradation due to undesirable series inductance.

Additional Detailed Technical Information <i>additional information is available on our dash board.</i>	
Performance Data	Data Table
	Swept Graphs
	S-Parameter (S2P Files) Data Set with and without port extension(.zip file)
Case Style	Die
Die Ordering and packaging information	Quantity, Package Model No.
	Small, Gel - Pak: 5,10,50,100 KGD* PMA2-162LN-DG+ Medium†, Partial wafer: KGD* <850 PMA2-162LN-DP+ Large†, Full Wafer PMA2-162LN-DF+
	† Available upon request contact sales representative
	Refer to AN-60-067
Environmental Ratings	ENV80

*Known Good Dice ("KGD") means that the dice in question have been subjected to Mini-Circuits DC test performance criteria and measurement instructions and that the parametric data of such dice fall within a predefined range. While DC testing is not definitive, it does help to provide a higher degree of confidence that dice are capable of meeting typical RF electrical parameters specified by Mini-Circuits.

ESD Rating**

Human Body Model (HBM): Class 1B (pass 500V) in accordance with ANSI/ESD STM 5.1 - 2001

** Tested in industry standard MCLP 2 x 2 mm, 8-lead package.

Additional Notes

- A. Performance and quality attributes and conditions not expressly stated in this specification document are intended to be excluded and do not form a part of this specification document.
- B. Electrical specifications and performance data contained in this specification document are based on Mini-Circuit's applicable established test performance criteria and measurement instructions.
- C. The parts covered by this specification document are subject to Mini-Circuits standard limited warranty and terms and conditions (collectively, "Standard Terms"); Purchasers of this part are entitled to the rights and benefits contained therein. For a full statement of the Standard Terms and the exclusive rights and remedies thereunder, please visit Mini-Circuits' website at www.minicircuits.com/MCLStore/terms.jsp
- D. Mini-Circuits does not warrant the accuracy or completeness of the information, text, graphics and other items contained within this document and same are provided as an accommodation and on an "As is" basis, with all faults.
- E. Purchasers of this part are solely responsible for proper storing, handling, assembly and processing of Known Good Dice (including, without limitation, proper ESD preventative measures, die preparation, die attach, wire bonding and related assembly and test activities), and Mini-Circuits assumes no responsibility therefor or for environmental effects on Known Good Dice.
- F. Mini-Circuits and the Mini-Circuits logo are registered trademarks of Scientific Components Corporation d/b/a Mini-Circuits. All other third-party trademarks are the property of their respective owners. A reference to any third-party trademark does not constitute or imply any endorsement, affiliation, sponsorship, or recommendation by any such third-party of Mini-Circuits or its products.

Typical Performance Data

NOTE: Use PDF Bookmarks to view DATA at required conditions

Definitions:

- Input Return Loss = -S11 (dB)
- Gain(Power Gain) = S21 (dB)
- Reverse Isolation = -S12 (dB)
- Output Return Loss = -S22 (dB)

TEST CONDITIONS: Vd = 4V, Id = 54.09mA, R1=267 Ohms @ Temperature = +25degC

FREQ	Gain	Isolation	Input Return Loss	Output Return Loss	Stability		IP-3 Output	1dB Comp. Output	FREQ	Noise Figure
					K	Measure				
(MHz)	(dB)	(dB)	(dB)	(dB)	K	Measure	(dBm)	(dBm)	(MHz)	(dB)
500	21.78	42.23	2.02	6.93	1.92	1.23	27.48	16.87	500.0	1.18
525	22.53	41.02	2.59	7.73	1.89	1.21	27.95	17.34	600.0	1.01
550	23.13	40.30	3.28	8.57	1.92	1.19	27.79	17.75	700.0	0.51
575	23.59	39.70	4.08	9.45	1.97	1.16	27.79	18.12	800.0	0.47
600	23.94	38.83	4.97	10.31	1.94	1.12	28.24	18.25	900.0	0.37
625	24.18	38.76	5.96	11.21	2.04	1.09	28.29	18.88	1000.0	0.39
650	24.32	38.36	7.04	12.10	2.06	1.06	28.58	19.09	1100.0	0.43
675	24.40	37.86	8.21	12.90	2.06	1.02	28.79	19.35	1200.0	0.51
700	24.43	38.04	9.45	13.64	2.18	1.01	29.24	19.57	1300.0	0.41
725	24.40	37.80	10.77	14.36	2.20	0.99	29.44	19.58	1400.0	0.55
750	24.33	37.95	12.21	15.02	2.31	0.97	29.69	19.91	1500.0	0.61
775	24.25	37.63	13.78	15.57	2.30	0.96	30.06	19.94	1600.0	0.60
800	24.14	37.66	15.47	16.12	2.37	0.95	30.42	19.85	1700.0	0.58
825	24.02	37.52	17.41	16.70	2.39	0.95	30.54	20.22	1800.0	0.74
850	23.88	37.50	19.50	17.20	2.44	0.94	30.40	20.22	1900.0	0.68
875	23.73	37.50	21.84	17.71	2.49	0.94	30.84	19.99	2000.0	0.78
900	23.58	37.31	24.22	18.16	2.49	0.94	30.53	20.53	2100.0	0.76
925	23.42	37.40	26.19	18.51	2.56	0.95	30.94	20.18	2200.0	0.81
950	23.26	37.59	27.29	18.85	2.66	0.95	30.95	20.07	2300.0	0.92
975	23.10	37.56	26.41	19.15	2.70	0.95	30.49	20.28	2400.0	0.95
1000	22.93	37.52	24.92	19.33	2.74	0.96	30.25	20.02	2500.0	1.09
1050	22.60	37.72	22.00	19.47	2.89	0.96	30.84	20.02	2600.0	1.04
1100	22.27	37.43	19.69	19.29	2.88	0.97	30.74	20.00	2700.0	1.19
1150	21.94	37.53	17.93	18.72	3.00	0.98	30.71	20.02	2800.0	1.21
1200	21.62	37.66	16.93	18.08	3.12	0.98	30.64	20.06	2900.0	1.25
1250	21.30	37.84	15.96	17.18	3.27	0.99	30.37	20.10	3000.0	1.16
1300	20.99	37.78	15.35	16.24	3.32	0.99	30.44	19.81	3100.0	1.46
1350	20.68	37.72	14.83	15.27	3.38	0.99	30.39	19.58	3200.0	1.46
1400	20.38	37.76	14.26	14.36	3.46	0.99	30.21	19.36	3300.0	1.51
1500	19.78	37.99	13.41	12.69	3.69	0.99	30.35	19.58	3400.0	1.59
1550	19.47	38.16	13.13	11.92	3.83	0.98	29.89	18.84	3500.0	1.49
1600	19.18	38.04	12.91	11.19	3.84	0.97	30.04	18.92	3600.0	1.75
1700	18.59	38.11	12.40	9.85	3.98	0.95	29.43	18.19	3700.0	1.78
1800	17.99	38.52	11.88	8.73	4.26	0.93	29.60	18.25	3800.0	1.77
1900	17.37	38.65	11.50	7.76	4.42	0.90	29.74	18.07	3900.0	1.84
2000	16.73	38.95	11.33	7.25	4.78	0.88	29.02	17.45	4000.0	1.78
2100	16.25	39.04	11.02	6.38	4.79	0.84	29.18	17.40		
2200	15.69	39.02	10.74	5.66	4.78	0.81	29.04	17.34		
2300	15.12	39.54	10.55	5.10	5.11	0.77	28.59	16.44		
2400	14.53	39.69	10.27	4.60	5.20	0.73	27.88	15.96		
2500	13.95	39.71	10.05	4.19	5.25	0.70	28.02	15.58		
2600	13.38	40.18	9.92	3.83	5.58	0.66	27.18	15.10		
2700	12.81	39.59	9.71	3.51	5.21	0.63	27.03	14.84		
2800	12.24	39.75	9.48	3.25	5.34	0.60	26.66	14.26		
2900	11.70	39.38	9.36	3.02	5.15	0.58	26.49	13.97		
3000	11.17	39.44	9.21	2.83	5.23	0.55	25.59	13.54		
3100	10.65	39.19	9.00	2.62	5.06	0.53	25.64	13.10		
3200	10.14	38.88	8.93	2.46	4.91	0.51	24.56	12.46		
3300	9.67	38.08	8.81	2.29	4.43	0.48	24.57	12.11		
3400	9.20	38.03	8.68	2.14	4.38	0.46	24.03	11.83		
3500	8.74	37.19	8.56	2.02	3.97	0.44	23.31	11.43		
3600	8.26	36.71	8.50	1.92	3.79	0.43	23.01	10.94		
3700	7.85	36.22	8.32	1.86	3.62	0.42	22.59	10.60		
3800	7.41	35.38	8.17	1.75	3.23	0.40	22.07	10.37		
3900	6.98	34.60	8.24	1.72	3.06	0.40	21.48	9.86		
4000	6.60	33.52	8.12	1.68	2.72	0.40	21.64	9.63		

Note: Test data of Die packaged in industry standard, 2x2mm, 8-lead MCLP package



Typical Performance Data

Definitions:

Input Return Loss = -S11 (dB)
 Gain(Power Gain) = S21 (dB)
 Reverse Isolation = -S12 (dB)
 Output Return Loss = -S22 (dB)

TEST CONDITIONS: Vd = 3.8V, Id = 50.72mA, R1=267 Ohms @ Temperature = +25degC

FREQ (MHz)	Gain (dB)	Isolation (dB)	Input Return Loss (dB)	Output Return Loss (dB)	Stability		IP-3 Output (dBm)	1dB Comp. Output (dBm)	FREQ (MHz)	Noise Figure (dB)
					K	Measure				
500	21.62	41.85	2.00	6.93	1.87	1.23	26.95	16.34	500.0	1.16
525	22.38	40.96	2.59	7.74	1.90	1.21	27.32	16.79	600.0	1.01
550	22.99	39.98	3.27	8.59	1.89	1.19	27.42	17.22	700.0	0.52
575	23.46	39.30	4.08	9.49	1.92	1.15	27.48	17.62	800.0	0.49
600	23.82	38.92	4.99	10.38	1.98	1.12	27.72	17.73	900.0	0.45
625	24.06	38.22	5.98	11.31	1.96	1.08	27.83	18.37	1000.0	0.36
650	24.21	38.13	7.08	12.21	2.05	1.05	28.15	18.54	1100.0	0.45
675	24.29	37.79	8.28	13.02	2.07	1.02	28.33	18.84	1200.0	0.50
700	24.32	37.47	9.56	13.83	2.09	1.00	28.75	19.06	1300.0	0.43
725	24.29	37.43	10.93	14.56	2.15	0.98	29.16	19.08	1400.0	0.57
750	24.22	37.55	12.41	15.21	2.25	0.97	29.32	19.40	1500.0	0.60
775	24.14	37.23	14.06	15.84	2.24	0.95	29.99	19.43	1600.0	0.61
800	24.02	37.31	15.81	16.42	2.32	0.95	30.16	19.36	1700.0	0.58
825	23.90	37.13	17.82	16.99	2.33	0.94	30.16	19.70	1800.0	0.77
850	23.76	37.19	20.00	17.52	2.40	0.94	30.29	19.73	1900.0	0.68
875	23.61	37.10	22.28	18.03	2.43	0.94	30.85	19.51	2000.0	0.80
900	23.45	37.13	24.55	18.51	2.48	0.94	30.42	20.04	2100.0	0.79
925	23.29	37.10	25.87	18.85	2.52	0.95	30.71	19.68	2200.0	0.80
950	23.13	37.16	25.95	19.19	2.58	0.95	30.60	19.61	2300.0	0.88
975	22.97	37.21	24.77	19.47	2.64	0.95	30.55	19.82	2400.0	0.93
1000	22.80	37.20	23.26	19.64	2.68	0.96	30.05	19.57	2500.0	1.08
1050	22.47	37.33	20.74	19.78	2.80	0.97	30.35	19.57	2600.0	1.07
1100	22.14	37.26	18.70	19.50	2.86	0.97	30.48	19.55	2700.0	1.25
1150	21.80	37.51	17.14	18.89	3.03	0.98	30.57	19.60	2800.0	1.19
1200	21.48	37.34	16.20	18.14	3.05	0.99	30.68	19.62	2900.0	1.28
1250	21.16	37.39	15.32	17.25	3.15	0.99	30.38	19.68	3000.0	1.32
1300	20.85	37.39	14.73	16.23	3.22	0.99	29.97	19.37	3100.0	1.38
1350	20.53	37.51	14.25	15.26	3.34	0.99	30.28	19.15	3200.0	1.55
1400	20.23	37.50	13.74	14.33	3.40	1.00	29.67	18.96	3300.0	1.56
1500	19.62	37.72	12.94	12.65	3.62	0.99	29.88	19.17	3400.0	1.61
1550	19.32	37.80	12.70	11.86	3.72	0.98	29.83	18.43	3500.0	1.58
1600	19.02	37.90	12.48	11.15	3.82	0.98	29.87	18.53	3600.0	1.78
1700	18.43	38.18	12.03	9.82	4.05	0.96	29.32	17.80	3700.0	1.73
1800	17.83	38.38	11.53	8.70	4.24	0.93	29.56	17.83	3800.0	1.79
1900	17.21	38.79	11.16	7.73	4.54	0.91	29.09	17.65	3900.0	1.91
2000	16.56	38.50	11.04	7.21	4.59	0.89	28.62	17.07	4000.0	1.77
2100	16.09	38.88	10.71	6.35	4.75	0.85	28.62	17.01		
2200	15.53	38.83	10.48	5.64	4.72	0.81	28.80	16.92		
2300	14.95	39.28	10.28	5.07	5.00	0.77	27.75	15.92		
2400	14.37	39.60	10.04	4.56	5.20	0.73	27.36	15.46		
2500	13.78	39.85	9.85	4.17	5.39	0.70	27.16	15.15		
2600	13.21	40.21	9.71	3.81	5.65	0.66	26.22	14.50		
2700	12.64	39.97	9.51	3.49	5.50	0.63	26.05	14.30		
2800	12.07	39.55	9.27	3.23	5.26	0.60	25.77	13.89		
2900	11.54	39.52	9.18	3.01	5.29	0.58	25.41	13.45		
3000	11.00	39.44	9.04	2.81	5.27	0.55	24.53	12.99		
3100	10.48	39.27	8.84	2.61	5.16	0.53	24.69	12.52		
3200	9.97	39.01	8.76	2.44	5.03	0.51	23.56	11.90		
3300	9.50	38.38	8.65	2.27	4.63	0.48	23.54	11.57		
3400	9.03	37.87	8.52	2.13	4.33	0.46	23.01	11.30		
3500	8.57	37.16	8.42	2.01	3.99	0.44	22.24	10.79		
3600	8.08	36.84	8.37	1.90	3.87	0.43	22.01	10.32		
3700	7.68	36.31	8.18	1.85	3.68	0.42	21.58	10.04		
3800	7.24	35.22	8.04	1.74	3.20	0.41	21.17	9.81		
3900	6.81	35.13	8.08	1.73	3.33	0.40	20.56	9.30		
4000	6.44	33.75	7.98	1.68	2.84	0.40	20.73	9.03		

Note: Test data of Die packaged in industry standard, 2x2mm, 8-lead MCLP package



Typical Performance Data

Definitions:

Input Return Loss = -S11 (dB)
 Gain(Power Gain) = S21 (dB)
 Reverse Isolation = -S12 (dB)
 Output Return Loss = -S22 (dB)

TEST CONDITIONS: Vd =4.2V, Id = 57.17mA, R1=267 Ohms @ Temperature = +25degC

FREQ	Gain	Isolation	Input Return Loss	Output Return Loss	Stability		IP-3 Output	1dB Comp. Output	FREQ	Noise Figure
					K	Measure				
(MHz)	(dB)	(dB)	(dB)	(dB)	K	Measure	(dBm)	(dBm)	(MHz)	(dB)
500	21.93	42.37	2.03	6.92	1.92	1.23	28.05	17.28	500.0	1.15
525	22.67	41.37	2.61	7.72	1.93	1.21	28.24	17.78	600.0	0.92
550	23.25	40.64	3.29	8.54	1.96	1.19	28.26	18.21	700.0	0.50
575	23.71	40.04	4.08	9.40	2.00	1.16	28.32	18.58	800.0	0.48
600	24.06	39.41	4.96	10.26	2.02	1.12	28.52	18.72	900.0	0.41
625	24.29	38.99	5.93	11.14	2.05	1.09	28.51	19.31	1000.0	0.34
650	24.43	38.62	6.98	11.99	2.09	1.06	28.91	19.56	1100.0	0.42
675	24.51	38.47	8.13	12.73	2.15	1.03	29.18	19.81	1200.0	0.47
700	24.53	38.33	9.34	13.46	2.20	1.01	29.78	20.02	1300.0	0.41
725	24.50	38.02	10.63	14.14	2.22	0.99	30.12	20.02	1400.0	0.55
750	24.43	37.90	12.02	14.74	2.26	0.97	29.91	20.36	1500.0	0.61
775	24.35	37.94	13.53	15.30	2.34	0.96	30.48	20.36	1600.0	0.59
800	24.25	37.78	15.16	15.84	2.36	0.95	30.54	20.28	1700.0	0.59
825	24.12	37.92	16.99	16.39	2.46	0.95	30.63	20.64	1800.0	0.74
850	23.98	37.81	18.99	16.88	2.49	0.95	30.80	20.63	1900.0	0.67
875	23.84	37.80	21.19	17.36	2.54	0.95	30.97	20.40	2000.0	0.80
900	23.69	37.86	23.69	17.79	2.61	0.95	30.83	20.93	2100.0	0.77
925	23.53	37.94	26.21	18.10	2.68	0.95	31.22	20.59	2200.0	0.77
950	23.38	37.79	28.14	18.48	2.69	0.95	31.36	20.49	2300.0	0.91
975	23.22	37.99	28.05	18.75	2.80	0.95	30.97	20.70	2400.0	0.93
1000	23.05	37.85	26.63	18.98	2.80	0.96	30.92	20.42	2500.0	1.05
1050	22.73	38.18	23.46	19.21	3.00	0.96	30.90	20.42	2600.0	1.06
1100	22.40	38.02	20.79	19.04	3.04	0.97	31.15	20.38	2700.0	1.24
1150	22.07	38.02	18.82	18.61	3.13	0.98	30.78	20.40	2800.0	1.22
1200	21.76	37.96	17.71	18.00	3.19	0.98	30.89	20.45	2900.0	1.29
1250	21.44	38.05	16.67	17.20	3.31	0.98	30.69	20.47	3000.0	1.18
1300	21.13	38.12	15.97	16.25	3.42	0.99	30.68	20.15	3100.0	1.38
1350	20.82	38.13	15.41	15.34	3.50	0.99	30.40	19.95	3200.0	1.48
1400	20.52	38.27	14.81	14.44	3.63	0.99	30.17	19.74	3300.0	1.56
1500	19.92	38.29	13.87	12.78	3.78	0.98	30.25	19.92	3400.0	1.59
1550	19.62	38.45	13.59	12.00	3.92	0.98	30.03	19.20	3500.0	1.52
1600	19.33	38.38	13.34	11.28	3.96	0.97	30.08	19.30	3600.0	1.72
1700	18.74	38.51	12.81	9.94	4.13	0.95	29.68	18.55	3700.0	1.80
1800	18.15	38.80	12.25	8.81	4.36	0.93	29.75	18.62	3800.0	1.89
1900	17.53	39.09	11.81	7.83	4.61	0.90	29.80	18.40	3900.0	1.86
2000	16.88	38.95	11.68	7.31	4.74	0.88	29.36	17.83	4000.0	1.83
2100	16.42	39.53	11.29	6.45	5.03	0.84	29.38	17.77		
2200	15.86	39.45	11.00	5.72	4.99	0.80	29.30	17.73		
2300	15.29	40.02	10.78	5.15	5.36	0.77	28.73	16.76		
2400	14.70	39.57	10.51	4.64	5.10	0.73	28.42	16.33		
2500	14.12	39.78	10.26	4.22	5.25	0.70	28.40	16.06		
2600	13.55	40.16	10.13	3.87	5.53	0.66	27.92	15.48		
2700	12.98	40.06	9.90	3.55	5.47	0.63	27.51	15.14		
2800	12.41	39.86	9.66	3.28	5.36	0.60	27.38	14.80		
2900	11.88	39.60	9.54	3.05	5.24	0.58	27.24	14.40		
3000	11.34	39.38	9.38	2.85	5.15	0.55	26.31	13.96		
3100	10.82	39.18	9.16	2.65	5.02	0.53	26.46	13.56		
3200	10.31	38.93	9.09	2.48	4.91	0.51	25.45	12.89		
3300	9.84	38.04	8.96	2.31	4.39	0.48	25.44	12.56		
3400	9.37	37.80	8.81	2.16	4.23	0.46	24.83	12.37		
3500	8.91	37.05	8.72	2.04	3.87	0.45	24.28	11.91		
3600	8.44	36.93	8.63	1.93	3.85	0.43	24.00	11.44		
3700	8.03	36.13	8.46	1.87	3.54	0.42	23.47	11.15		
3800	7.59	35.16	8.31	1.76	3.12	0.41	22.90	10.89		
3900	7.16	34.53	8.38	1.74	3.02	0.40	22.34	10.41		
4000	6.78	33.61	8.27	1.69	2.74	0.40	22.39	10.16		

Note: Test data of Die packaged in industry standard, 2x2mm, 8-lead MCLP package



Typical Performance Curves

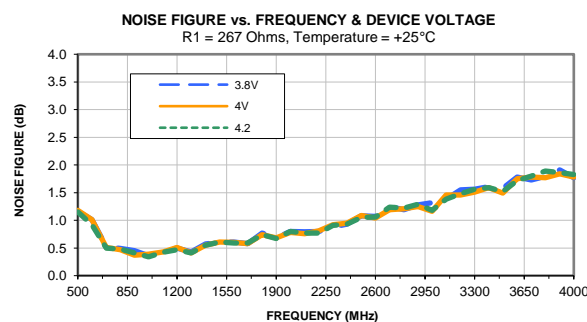
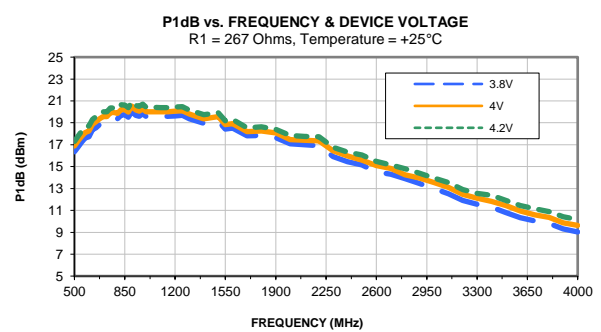
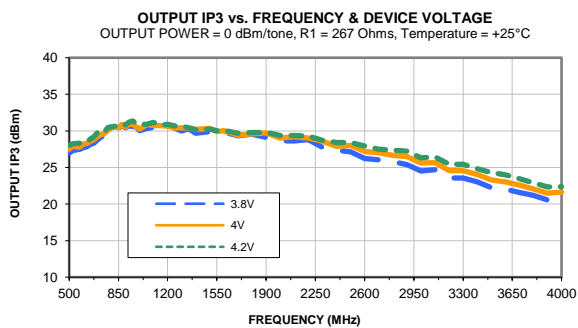
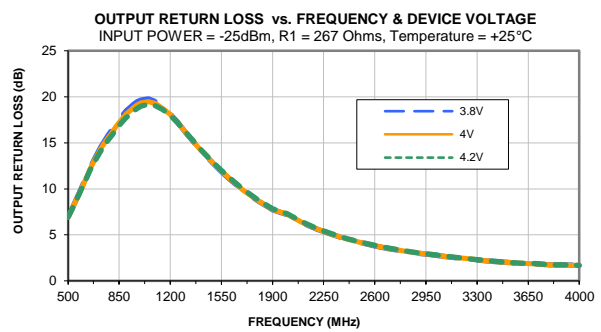
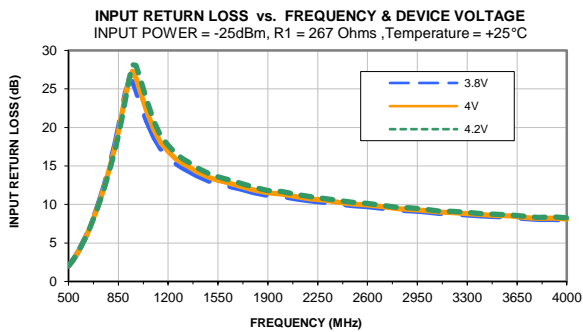
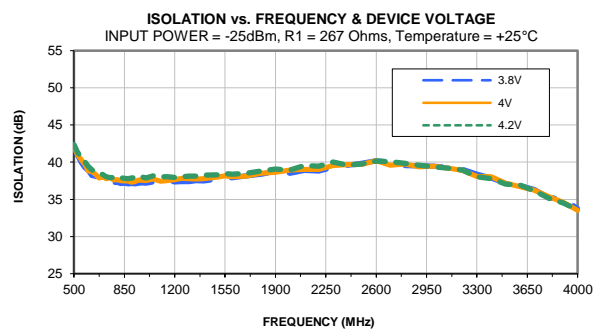
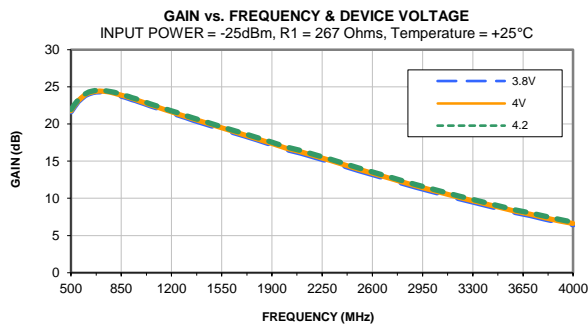

Note: Test data of Die packaged in industry standard, 2x2mm, 8-lead MCLP package

All Mini-Circuits products are manufactured under exacting quality assurance and control standards, and are capable of meeting published specifications after being subjected to any or all of the following physical and environmental test.

Specification	Test/Inspection Condition	Reference/Spec
Operating Temperature	-40° to 85° C or -40° to 105° C or -55° to 105° C or -45° to 105° C Ambient Environment	Refer to Individual Model Data Sheet
Storage Environment (Die)	-65° to 150°C	Individual Model Data Sheet
Storage Environment(Packaging)	-40° to 70°C and 40 to 60% humidity (In Factory Shipped Package)	