



LOW NOISE, HIGH IP3

# Monolithic Amplifier

## PMA-5453+

50Ω 0.05 to 6 GHz

### THE BIG DEAL

- Ultra Low Noise Figure, 0.6 dB
- High IP3, 35 dBm typ. 1 GHz
- Wideband, up to 6 GHz
- Single Positive Supply Voltage, 3V, Id=60mA
- Ultra Low Noise Figure, 0.6 dB typ. at 0.5 GHz
- Gain, 19 dB typ. at 1 GHz
- Output Power, up to +19.5dBm typ.
- Micro-miniature size - 3mm x 3mm
- Aqueous washable

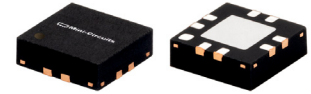

Generic photo used for illustration purposes only

CASE STYLE: DQ849

### +RoHS Compliant

The +Suffix identifies RoHS Compliance. See our web site for RoHS Compliance methodologies and qualifications

### APPLICATIONS

- Cellular
- ISM
- GSM
- WCDMA
- LTE
- WiMAX
- WLAN
- UNII and HIPERLAN

### PRODUCT OVERVIEW

Mini-Circuits PMA-5453+ is a E-PHEMT\* based Ultra-Low Noise MMIC Amplifier operating from 50 MHz to 6 GHz with a unique combination of low noise and high IP3 making this amplifier ideal for sensitive receiver applications. This design operates on a single 3V supply at only 60 mA and is internally matched to 50 Ohms.

### KEY FEATURES

Feature	Advantages
Ultra Low Noise, 0.6 dB	Outstanding Noise Figure, measured in a 50 Ohm environment without any external matching
High IP3, 35 dBm	Combining Low Noise and High IP3 makes this MMIC amplifier ideal for Low Noise Receiver Front End (RFE) because it gives the user advantages at both ends of the dynamic range: sensitivity & two-tone spur-free dynamic range
Low Current, 60 mA	At only 60mA, the PMA-5453+ is ideal for remote applications with limited available power or densely packed applications where thermal management is critical.
Broad Band	Operating over a broadband the PMA-5453+ covers the primary wireless communications bands: Cellular, PCS, LTE, WiMAX
Internally Matched	No external matching elements required to achieve the advertised noise and output power over the full band
MCLP Package	Low Inductance, repeatable transitions, excellent thermal pad
Max Input Power, +20 dBm	Ruggedized design operates up to input powers of +20dBm without the need of an external limiter
High Reliability	Low, small signal operating current of 60 mA nominal maintains junction temperatures typically below 110°C at 85°C ground lead temperature

\*Enhancement mode Pseudomorphic High Electron Mobility Transistor.





LOW NOISE, HIGH IP3

# Monolithic Amplifier

## PMA-5453+

### ELECTRICAL SPECIFICATIONS<sup>(1)</sup> AT 25°C, Z<sub>0</sub>=50Ω, (REFER TO CHARACTERIZATION CIRCUIT, FIG. 1)

Parameter	Condition (GHz)	Min.	Typ.	Max.	Units
Frequency Range		0.05		6.0	GHz
DC Voltage (V <sub>d</sub> )			3.0		V
DC Current (I <sub>d</sub> ) <sup>(6)</sup>		40	60	71	mA
DC Current (I <sub>Rbias</sub> )			4.0		mA
Noise Figure	0.05		1.2	—	dB
	0.5		0.6	—	
	1.0		0.7	—	
	2.0		0.9	1.3	
	3.0		1.3	—	
	4.0		1.5	—	
	5.0		1.8	—	
Gain	0.05	—	25.8	—	dB
	0.5	—	23.0	—	
	1.0	—	19.3	—	
	2.0	12.8	14.3	15.6	
	3.0	—	11.1	—	
	4.0	—	9.0	—	
	5.0	—	7.2	—	
Input Return Loss	0.05-0.5		10.0		dB
	0.5-6		7.0		
Output Return Loss	0.05-0.1		16.0		dB
	0.1-6		18.0		
Output IP3	0.05		32.1		dBm
	0.5		33.1		
	1.0		35.0		
	2.0		36.8		
	3.0		37.4		
	4.0		38.8		
	5.0		39.0		
Output Power @ 1 dB compression <sup>(2)</sup>	0.05		19.4		dBm
	0.5		19.2		
	1.0		19.1		
	2.0		19.4		
	3.0		19.6		
	4.0		19.8		
	5.0		19.9		
6.0		20.0			
DC Current Variation vs. Temperature <sup>(3)</sup>			-0.033		mA/°C
Thermal Resistance			128		°C/W

### MAXIMUM RATINGS<sup>(4)</sup>

Parameter	Ratings
Operating Temperature <sup>(5)</sup>	-40°C to 85°C
Storage Temperature	-55°C to 100°C
Channel Temperature	150°C
DC Voltage (Pad 6)	5V
Power Dissipation	500mW
DC Current (Pad 6)	130mA
Bias Current (Pad 7)	10mA
Input Power <sup>(7)</sup>	20dBm

- (1) Measured on Mini-Circuits Characterization test board TB-502+ See Characterization Test Circuit (Fig. 1)
- (2) P1dB specified with external current limiting of 70mA; Capable of higher P1dB at higher current (see Fig. 2)
- (3) (Current at 85°C - Current at -45°C)/130
- (4) Permanent damage may occur if any of these limits are exceeded. These maximum ratings are not intended for continuous normal operation.
- (5) Defined with reference to ground pad temperature.
- (6) Specified DC current consumption is under small signal conditions. Current will increase with input RF Power. To maintain maximum current consumption, external DC current limiting circuits are required on Vd line.
- (7) Maximum input power is specified based upon external Vd current limiting of 80 mA. Maximum input power will degrade without external current limiting.





LOW NOISE, HIGH IP3

# Monolithic Amplifier

## PMA-5453+

### SIMPLIFIED SCHEMATIC AND PAD DESCRIPTION

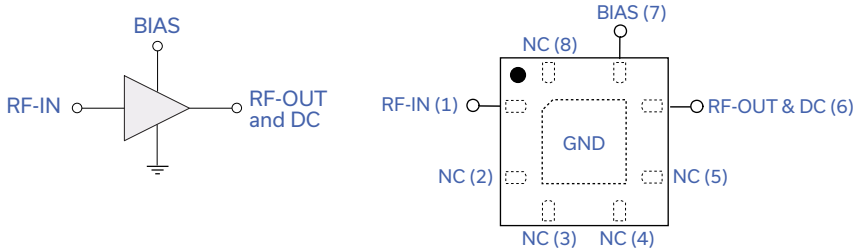

Function	Pad Number	Description (See Application Circuit, Fig. 3)
RF-IN	1	RF input pad
RF-OUT & DC	6	RF output pad (connected to RF-OUT via blocking external cap C2, and Supply voltage Vs via RF Choke L1)
BIAS	7	Bias pad (connected to Vs via Rbias)
GND	paddle in center of bottom	Connected to ground
NOT USED	2,3,4,5,8	No internal connection; recommended use: per PCB Layout PL-299

### CHARACTERIZATION TEST CIRCUIT

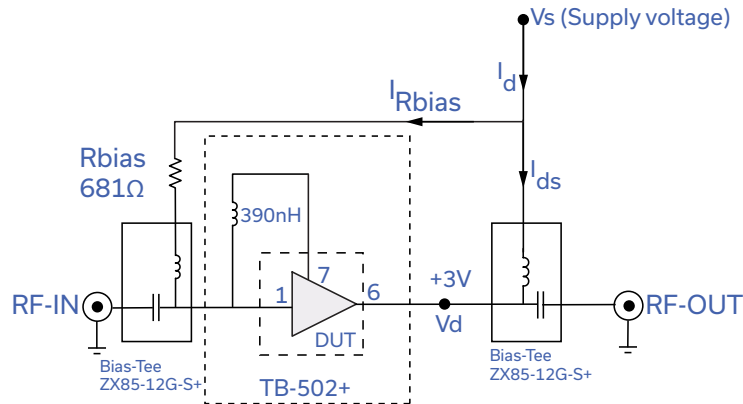

Fig 1. Block Diagram of Test Circuit used for characterization. (DUT soldered on Mini-Circuits Characterization Test Board TB-502+) Gain, Output power at 1dB compression (P1dB), Output IP3 (OIP3) and Noise Figure measured using Agilent's N5242A PNA-X Microwave network analyzer.

Conditions:

1. Gain: Pin=-25 dBm
2. Output IP3 (OIP3): Two tones, spaced 1 MHz apart, 5 dBm/tone at output.
3. Vs adjusted for 3V at device (Vd), compensating loss of bias tee.

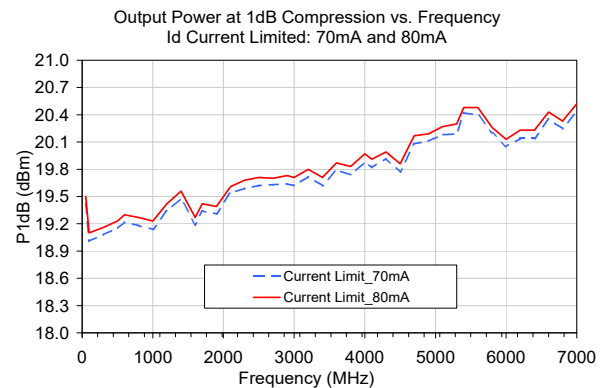
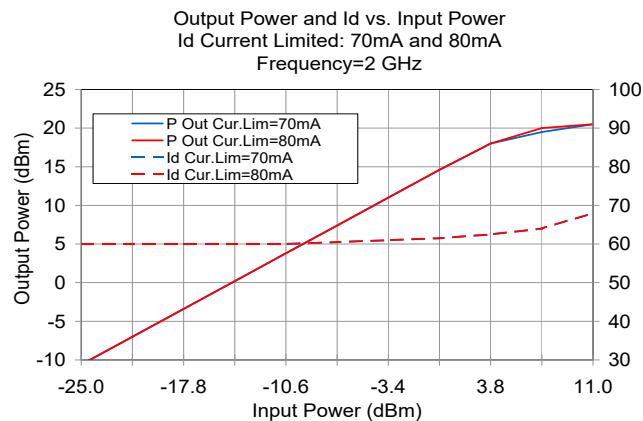

Fig 2. Output Power and Id vs. Input Power and Frequency. Performance measured on Mini-Circuits Characterization test board TB-502+. See Characterization Test Circuit (Fig. 1). Measurements performed with current (Id) limited as noted.





LOW NOISE, HIGH IP3

# Monolithic Amplifier

## PMA-5453+

### RECOMMENDED APPLICATION CIRCUIT

(refer to evaluation board for PCB Layout and component values)

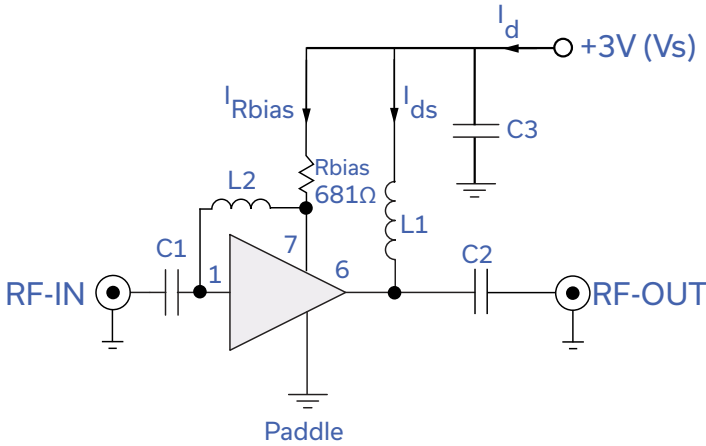

Fig 3. Recommended Application Circuit  
Note: Resistance of L1, 0.1-0.2Ω typically

Typical Current ( $I_d$ ) as a function of  $R_{bias}$   
( $V_d = 3V$ )

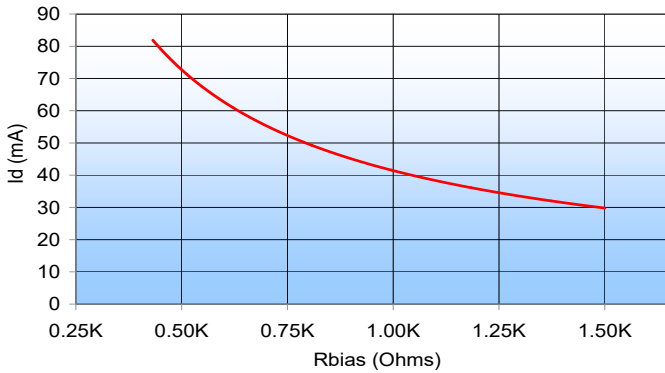
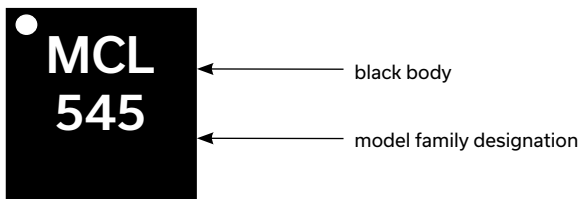

Fig 4.  $I_d$  varies as a function of  $R_{bias}$ . The  $I_d$  current range is defined based upon the specific  $R_{bias}$  value noted in the Application Circuit (Fig 3).  $R_{bias}$  may be adjusted to optimize  $I_d$  for a customers' application. RF performance will vary accordingly.

### PRODUCT MARKING



Marking may contain other features or characters for internal lot control



LOW NOISE, HIGH IP3

# Monolithic Amplifier

## PMA-5453+

Mini-Circuits

ADDITIONAL DETAILED TECHNICAL INFORMATION IS AVAILABLE ON OUR DASH BOARD. TO ACCESS [CLICK HERE](#)

Performance Data	Graphs, s-parameter data set (.zip file)
Case Style	DQ849 Plastic package, exposed paddle, lead finish: tin-silver over nickel
Tape & Reel	F104
Standard quantities available on reel	7" reels with 20, 50, 100, 200, 500, 1K or 2K devices
Suggested Layout for PCB Design	PL- 299
Evaluation Board	TB-501-3+ (50-5000 MHz)
Environmental Ratings	ENV08T1

### ESD RATING

Human Body Model (HBM): Class 1A (250V to <500V) in accordance with ANSI/ESD STM 5.1 - 2001

Machine Model (MM): Class M1 (<100V) in accordance with ANSI/ESD STM5.2-1999; passes 40V

### MSL RATING

Moisture Sensitivity: MSL1 in accordance with IPC/JEDEC J-STD-020D

### MSL TEST FLOW CHART

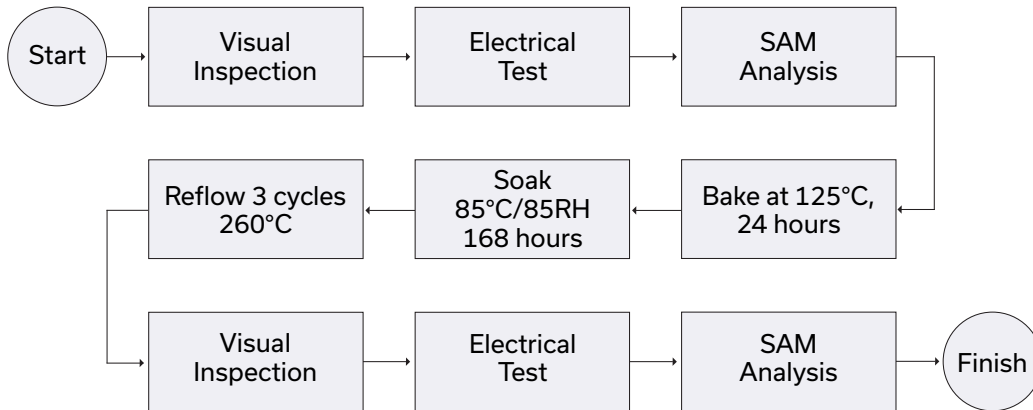

- NOTES**
- A. Performance and quality attributes and conditions not expressly stated in this specification document are intended to be excluded and do not form a part of this specification document.
  - B. Electrical specifications and performance data contained in this specification document are based on Mini-Circuit's applicable established test performance criteria and measurement instructions.
  - C. The parts covered by this specification document are subject to Mini-Circuits standard limited warranty and terms and conditions (collectively, "Standard Terms"); Purchasers of this part are entitled to the rights and benefits contained therein. For a full statement of the standard. Terms and the exclusive rights and remedies thereunder, please visit Mini-Circuits' website at [www.minicircuits.com/MCLStore/terms.jsp](http://www.minicircuits.com/MCLStore/terms.jsp)



## Typical Performance Data

**NOTE: Use PDF Bookmarks to view DATA at required conditions**

**Definitions:**

Input Return Loss = -S11 (dB)

Gain(Power Gain) = S21 (dB)

Reverse Isolation = -S12 (dB)

Output Return Loss = -S22 (dB)

TEST CONDITIONS: Vd = 3V, Rbias=681 ohms, Id=58 mA @ Temperature = +25degC

FREQ	Gain	Isolation	Input Return Loss	Output Return Loss	Stability		IP-3 Output	1dB Comp. Output (1)		Noise Figure
								Current Limit 70mA	Current Limit 80mA	
(MHz)	(dB)	(dB)	(dB)	(dB)	K	Measure	(dBm)	(dBm)		(dB)
50.0	25.89	31.85	11.02	12.12	1.10	0.77	32.39	19.42	19.50	1.02
100.0	25.73	30.72	11.15	17.30	1.07	0.76	32.51	19.01	19.10	0.74
300.0	24.58	29.70	9.67	23.49	1.06	0.82	33.21	19.08	19.16	0.58
500.0	23.00	28.53	8.32	23.92	1.05	0.88	33.21	19.15	19.23	0.55
600.0	22.19	27.89	7.87	23.63	1.05	0.90	34.12	19.22	19.30	0.62
800.0	20.63	26.78	7.23	23.33	1.06	0.94	34.77	19.18	19.27	0.64
1000.0	19.23	25.63	6.85	22.77	1.07	0.96	35.05	19.14	19.23	0.78
1200.0	17.97	24.66	6.53	22.21	1.08	0.99	36.10	19.34	19.42	0.79
1400.0	16.86	23.72	6.36	21.85	1.09	1.00	36.04	19.48	19.56	0.84
1600.0	15.85	22.87	6.18	21.31	1.10	1.01	36.64	19.19	19.27	0.90
1700.0	15.38	22.47	6.10	21.38	1.10	1.02	36.58	19.34	19.42	0.88
1900.0	14.56	21.67	6.10	21.19	1.10	1.01	37.15	19.31	19.39	0.85
2100.0	13.78	20.93	6.01	20.98	1.10	1.02	37.31	19.54	19.61	0.86
2300.0	13.10	20.28	6.02	21.21	1.10	1.02	37.56	19.59	19.68	0.99
2500.0	12.40	19.72	6.29	22.06	1.13	1.01	37.22	19.62	19.71	1.02
2700.0	11.68	19.16	5.94	20.70	1.12	1.04	37.74	19.63	19.70	1.32
2900.0	11.30	18.46	6.14	21.54	1.11	1.01	38.22	19.64	19.73	1.13
3000.0	11.05	18.20	6.25	21.86	1.11	1.01	38.35	19.62	19.71	1.08
3200.0	10.56	17.67	6.32	22.05	1.11	1.00	38.54	19.72	19.80	1.07
3400.0	10.13	17.16	6.56	22.79	1.12	0.99	38.65	19.62	19.71	1.21
3600.0	9.71	16.68	6.74	22.91	1.12	0.98	39.03	19.79	19.87	1.20
3800.0	9.33	16.19	6.89	23.20	1.12	0.97	38.90	19.74	19.83	1.26
4000.0	8.96	15.77	7.14	23.15	1.13	0.96	38.77	19.88	19.97	1.23
4100.0	8.74	15.60	7.18	22.57	1.13	0.96	38.59	19.82	19.91	1.18
4300.0	8.32	15.26	7.31	21.87	1.15	0.96	38.32	19.92	19.99	1.54
4500.0	7.97	14.84	7.54	21.18	1.15	0.94	39.16	19.77	19.86	1.47
4700.0	7.50	14.60	7.82	20.01	1.19	0.93	39.14	20.08	20.17	1.75
4900.0	7.27	14.20	7.27	19.83	1.15	0.94	40.33	20.11	20.19	1.56
5100.0	7.06	13.81	7.09	19.47	1.13	0.94	40.09	20.18	20.27	1.57
5300.0	6.78	13.49	6.89	18.84	1.12	0.94	40.15	20.19	20.30	1.70
5400.0	6.64	13.36	6.81	18.42	1.12	0.94	40.50	20.42	20.48	1.69
5600.0	6.34	13.09	6.67	17.49	1.12	0.93	40.24	20.40	20.48	1.85
5800.0	6.05	12.87	6.48	16.72	1.12	0.94	40.93	20.20	20.26	2.02
6000.0	5.76	12.62	6.22	16.02	1.11	0.94	40.19	20.05	20.13	2.11
6200.0	5.47	12.44	5.97	15.35	1.11	0.95	41.08	20.14	20.23	2.11
6400.0	5.19	12.24	5.74	14.83	1.10	0.95	40.38	20.14	20.23	2.18
6600.0	4.88	12.08	5.56	14.11	1.11	0.96	39.92	20.35	20.43	2.18
6800.0	4.52	11.99	5.38	13.53	1.12	0.97	41.21	20.25	20.33	2.72
7000.0	4.02	12.05	5.75	12.83	1.18	0.96	40.88	20.43	20.52	2.83

(1) Current is externally limited during P1dB measurements. Unit is capable of higher output power if current is not limited.

## Typical Performance Data

### Definitions:

Input Return Loss = -S11 (dB)

Gain(Power Gain) = S21 (dB)

Reverse Isolation = -S12 (dB)

Output Return Loss = -S22 (dB)

TEST CONDITIONS: Vd = 3V, Rbias=681 ohms, Id=60 mA @ Temperature = -45degC

FREQ	Gain	Isolation	Input Return Loss	Output Return Loss	Stability		IP-3 Output	Noise Figure
					K	Measure		
(MHz)	(dB)	(dB)	(dB)	(dB)	K	Measure	(dBm)	(dB)
50.0	26.04	31.43	12.43	11.81	1.06	0.73	32.91	0.82
100.0	25.69	30.27	12.99	16.48	1.05	0.71	33.40	0.54
300.0	24.58	29.52	10.94	21.01	1.07	0.77	34.00	0.43
500.0	23.10	28.57	9.11	21.26	1.08	0.83	33.97	0.40
600.0	22.33	28.06	8.51	21.29	1.09	0.86	34.70	0.45
800.0	20.85	26.82	7.71	21.04	1.09	0.89	35.18	0.48
1000.0	19.48	25.76	7.19	20.62	1.09	0.92	35.75	0.58
1200.0	18.25	24.72	6.81	20.22	1.09	0.94	36.54	0.53
1400.0	17.16	23.72	6.58	20.02	1.09	0.95	36.56	0.66
1600.0	16.16	22.84	6.36	19.58	1.09	0.96	37.09	0.55
1700.0	15.71	22.41	6.27	19.68	1.09	0.97	37.24	0.83
1900.0	14.89	21.60	6.22	19.46	1.09	0.97	37.61	0.58
2100.0	14.12	20.84	6.11	19.49	1.09	0.98	37.54	0.60
2300.0	13.46	20.14	6.12	19.56	1.08	0.97	38.10	0.75
2500.0	12.74	19.63	6.39	20.23	1.11	0.97	37.83	0.76
2700.0	11.93	19.16	6.01	19.58	1.11	1.01	38.02	1.09
2900.0	11.67	18.31	6.18	20.09	1.08	0.97	38.85	0.78
3000.0	11.42	18.01	6.29	20.33	1.09	0.97	39.08	0.78
3200.0	10.95	17.47	6.41	20.79	1.08	0.96	39.10	0.79
3400.0	10.51	16.96	6.61	21.33	1.09	0.95	39.28	0.79
3600.0	10.11	16.46	6.81	21.83	1.09	0.94	39.04	0.82
3800.0	9.73	16.00	6.93	22.12	1.09	0.93	39.16	1.01
4000.0	9.38	15.56	7.21	22.39	1.09	0.92	39.42	0.92
4100.0	9.15	15.37	7.24	21.97	1.10	0.92	39.48	1.14
4300.0	8.73	15.03	7.32	21.01	1.11	0.91	39.28	1.01
4500.0	8.40	14.61	7.54	20.65	1.11	0.90	39.44	0.64
4700.0	7.95	14.35	7.74	19.09	1.13	0.89	39.67	1.30
4900.0	7.58	14.06	7.38	18.59	1.13	0.90	40.58	1.38
5100.0	7.45	13.61	7.05	18.22	1.10	0.89	40.36	1.13
5300.0	7.17	13.31	6.83	17.90	1.09	0.89	39.74	1.12
5400.0	7.01	13.16	6.71	17.14	1.09	0.89	40.48	1.18
5600.0	6.73	12.89	6.61	16.63	1.09	0.89	40.68	1.59
5800.0	6.43	12.65	6.42	15.85	1.08	0.89	40.32	1.37
6000.0	6.17	12.43	6.21	15.47	1.08	0.90	40.37	1.47
6200.0	5.86	12.22	5.90	14.67	1.07	0.90	40.63	1.35
6400.0	5.59	12.03	5.69	14.28	1.07	0.91	40.86	1.61
6600.0	5.29	11.86	5.45	13.43	1.07	0.91	41.12	1.63
6800.0	4.98	11.75	5.23	13.14	1.07	0.92	40.73	2.17
7000.0	4.53	11.74	5.35	12.24	1.11	0.92	40.63	1.78

## Typical Performance Data

### Definitions:

Input Return Loss = -S11 (dB)

Gain(Power Gain) = S21 (dB)

Reverse Isolation = -S12 (dB)

Output Return Loss = -S22 (dB)

TEST CONDITIONS: Vd = 3V, Rbias=681 ohms, Id=56 mA @ Temperature = +85degC

FREQ	Gain	Isolation	Input Return Loss	Output Return Loss	Stability		IP-3 Output	Noise Figure
					K	Measure		
(MHz)	(dB)	(dB)	(dB)	(dB)	K	Measure	(dBm)	(dB)
50.0	25.62	31.37	9.83	11.69	1.09	0.74	31.90	1.30
100.0	25.62	30.69	9.65	16.37	1.06	0.77	31.80	1.90
300.0	24.47	29.65	8.69	21.43	1.03	0.85	32.52	0.71
500.0	22.84	28.27	7.69	22.88	1.01	0.91	32.65	0.71
600.0	22.01	27.68	7.36	23.29	1.01	0.94	33.50	0.77
800.0	20.41	26.59	6.88	23.60	1.03	0.98	34.08	0.78
1000.0	19.00	25.57	6.59	23.92	1.05	1.00	34.42	0.77
1200.0	17.73	24.59	6.34	23.58	1.07	1.02	35.40	0.98
1400.0	16.62	23.72	6.21	23.47	1.08	1.03	35.39	1.00
1600.0	15.60	22.88	6.06	22.95	1.09	1.04	35.85	1.33
1700.0	15.12	22.48	5.99	23.00	1.10	1.05	36.16	1.18
1900.0	14.29	21.71	5.99	22.80	1.10	1.05	36.46	1.07
2100.0	13.51	21.01	5.92	22.60	1.11	1.05	36.78	1.14
2300.0	12.83	20.37	5.95	22.67	1.11	1.05	37.08	1.23
2500.0	12.13	19.82	6.18	23.57	1.14	1.05	37.11	1.30
2700.0	11.41	19.32	5.90	21.87	1.14	1.07	37.19	1.58
2900.0	11.01	18.60	6.09	22.81	1.13	1.05	37.81	1.48
3000.0	10.75	18.33	6.19	23.07	1.13	1.04	38.16	1.47
3200.0	10.26	17.83	6.28	23.28	1.14	1.04	37.98	1.47
3400.0	9.81	17.36	6.52	24.04	1.15	1.03	38.12	1.47
3600.0	9.40	16.85	6.69	23.86	1.15	1.01	38.28	1.66
3800.0	9.01	16.38	6.85	23.93	1.15	1.01	38.23	1.77
4000.0	8.64	15.98	7.07	23.68	1.16	1.00	38.44	1.79
4100.0	8.41	15.81	7.11	22.99	1.17	0.99	38.25	1.93
4300.0	7.98	15.48	7.26	22.28	1.18	0.99	37.72	1.86
4500.0	7.65	15.07	7.46	21.77	1.19	0.98	38.95	1.90
4700.0	7.20	14.84	7.71	20.77	1.22	0.97	38.46	2.13
4900.0	6.95	14.42	7.29	20.62	1.19	0.97	39.83	2.18
5100.0	6.74	14.04	7.04	20.23	1.17	0.97	39.78	2.16
5300.0	6.46	13.71	6.85	19.54	1.16	0.97	39.74	2.24
5400.0	6.33	13.56	6.81	19.30	1.15	0.97	39.80	2.27
5600.0	6.04	13.28	6.67	18.28	1.15	0.97	39.73	2.55
5800.0	5.74	13.05	6.43	17.40	1.15	0.98	40.22	2.47
6000.0	5.45	12.79	6.23	16.52	1.14	0.98	39.96	2.65
6200.0	5.16	12.61	6.00	16.03	1.14	0.99	40.20	2.62
6400.0	4.89	12.43	5.79	15.50	1.13	0.99	40.25	2.71
6600.0	4.57	12.26	5.61	14.76	1.14	1.00	39.59	2.80
6800.0	4.23	12.18	5.46	14.19	1.15	1.00	40.34	3.19
7000.0	3.76	12.19	5.72	13.33	1.21	0.99	41.07	3.27



## Typical Performance Data

### Definitions:

Input Return Loss = -S11 (dB)

Gain(Power Gain) = S21 (dB)

Reverse Isolation = -S12 (dB)

Output Return Loss = -S22 (dB)

TEST CONDITIONS: Vd = 3V, Id=40mA @ Temperature = +25degC (1)

FREQ	Gain	Isolation	Input Return Loss	Output Return Loss	Stability		IP-3 Output	1dB Comp. Output (2)		FREQ	Noise Figure
								Current Limit 70mA	Current Limit 80mA		
(MHz)	(dB)	(dB)	(dB)	(dB)	K	Measure	(dBm)	(dBm)		(MHz)	(dB)
50.0	25.04	30.64	10.27	10.94	1.09	0.70	29.36	19.42	19.50	50.0	1.02
100.0	25.02	30.24	10.20	15.66	1.08	0.76	29.45	19.01	19.10	100.0	0.74
300.0	24.04	29.05	8.95	21.17	1.03	0.82	29.85	19.08	19.16	400.0	0.64
500.0	22.59	27.97	7.82	23.62	1.02	0.90	30.42	19.15	19.23	600.0	0.66
600.0	21.82	27.37	7.38	24.57	1.01	0.93	30.80	19.22	19.30	800.0	0.73
800.0	20.32	26.35	6.77	25.94	1.02	0.98	31.43	19.18	19.27	1100.0	0.79
1000.0	18.95	25.42	6.40	26.46	1.04	1.01	31.69	19.14	19.23	1300.0	0.84
1200.0	17.71	24.49	6.14	26.14	1.05	1.03	32.80	19.34	19.42	1600.0	0.91
1400.0	16.61	23.64	5.96	25.71	1.06	1.05	32.51	19.48	19.56	1800.0	1.04
1600.0	15.63	22.83	5.84	25.07	1.07	1.06	33.04	19.19	19.27	2000.0	0.86
1700.0	15.17	22.45	5.78	24.93	1.08	1.06	33.82	19.34	19.42	2300.0	0.97
1900.0	14.34	21.73	5.75	24.28	1.09	1.06	33.16	19.31	19.39	2500.0	0.99
2100.0	13.59	21.01	5.74	24.23	1.09	1.06	32.84	19.54	19.61	2700.0	1.54
2300.0	12.92	20.33	5.76	24.37	1.09	1.06	33.46	19.59	19.68	3000.0	1.11
2500.0	12.31	19.68	5.87	24.60	1.10	1.05	33.85	19.62	19.71	3200.0	1.17
2700.0	11.44	19.36	5.72	22.78	1.12	1.09	33.87	19.63	19.70	3400.0	1.31
2900.0	11.20	18.52	5.91	23.65	1.10	1.05	34.01	19.64	19.73	3700.0	1.24
3000.0	10.97	18.24	5.99	23.82	1.10	1.04	34.31	19.62	19.71	3900.0	1.39
3200.0	10.53	17.71	6.12	24.04	1.10	1.03	33.96	19.72	19.80	4100.0	1.57
3400.0	10.10	17.15	6.27	24.09	1.10	1.02	35.06	19.62	19.71	4400.0	1.60
3600.0	9.71	16.67	6.39	24.04	1.10	1.01	34.88	19.79	19.87	4600.0	1.64
3800.0	9.32	16.21	6.53	23.80	1.10	1.00	34.79	19.74	19.83	4900.0	2.01
4000.0	8.94	15.79	6.60	23.11	1.10	0.99	33.95	19.88	19.97	5100.0	1.75
4100.0	8.74	15.60	6.63	22.59	1.10	0.99	34.68	19.82	19.91	5300.0	1.76
4300.0	8.34	15.25	6.59	21.24	1.10	0.99	33.55	19.92	19.99	5600.0	1.88
4500.0	8.01	14.88	6.56	20.24	1.10	0.98	34.89	19.77	19.86	5800.0	2.06
4700.0	7.65	14.57	6.64	19.32	1.12	0.97	34.46	20.08	20.17	6000.0	2.19
4900.0	7.11	14.40	6.91	18.34	1.16	0.97	34.84	20.11	20.19	6400.0	2.26
5100.0	7.01	13.89	6.14	18.17	1.09	0.98	34.68	20.18	20.27	6600.0	2.49
5300.0	6.74	13.58	5.92	17.45	1.08	0.98	35.34	20.19	20.30	6800.0	2.70
5400.0	6.60	13.42	5.84	17.10	1.08	0.98	34.10	20.42	20.48	7000.0	2.90
5600.0	6.30	13.16	5.67	16.44	1.07	0.98	34.97	20.40	20.48		
5800.0	6.01	12.92	5.49	15.81	1.07	0.98	36.20	20.20	20.26		
6000.0	5.70	12.72	5.38	15.25	1.07	0.99	35.53	20.05	20.13		
6200.0	5.43	12.49	5.16	14.76	1.06	0.99	34.63	20.14	20.23		
6400.0	5.16	12.26	4.98	14.29	1.05	1.00	35.17	20.14	20.23		
6600.0	4.88	12.09	4.83	13.83	1.05	1.00	35.99	20.35	20.43		
6800.0	4.59	11.93	4.71	13.43	1.06	1.00	34.91	20.25	20.33		
7000.0	4.23	11.86	4.68	12.89	1.08	1.00	34.78	20.43	20.52		

(1) External Rbias resistor is adjusted to obtain desired current

(2) Current is externally limited during P1dB measurements. Unit is capable of higher output power if current is not limited.

## Typical Performance Data

### Definitions:

Input Return Loss = -S11 (dB)

Gain(Power Gain) = S21 (dB)

Reverse Isolation = -S12 (dB)

Output Return Loss = -S22 (dB)

TEST CONDITIONS: Vd = 3V, Id=60mA @ Temperature = +25degC (1)

FREQ	Gain	Isolation	Input Return Loss	Output Return Loss	Stability		IP-3 Output	1dB Comp. Output (2)		FREQ	Noise Figure
								Current Limit 70mA	Current Limit 80mA		
(MHz)	(dB)	(dB)	(dB)	(dB)	K	Measure	(dBm)	(dBm)		(MHz)	(dB)
50.0	25.84	31.27	10.85	12.05	1.07	0.73	32.14	19.42	19.50	50.0	1.00
100.0	25.71	30.72	11.23	17.28	1.07	0.76	32.28	19.01	19.10	100.0	0.74
300.0	24.61	29.59	9.57	24.26	1.05	0.81	32.83	19.08	19.16	400.0	0.61
500.0	23.07	28.57	8.18	25.73	1.05	0.88	33.45	19.15	19.23	600.0	0.66
600.0	22.26	27.93	7.68	25.65	1.04	0.91	33.88	19.22	19.30	800.0	0.70
800.0	20.71	26.75	7.02	25.09	1.05	0.95	34.54	19.18	19.27	1100.0	0.78
1000.0	19.31	25.74	6.60	24.22	1.06	0.98	35.20	19.14	19.23	1300.0	0.82
1200.0	18.05	24.75	6.33	23.42	1.07	1.00	35.99	19.34	19.42	1600.0	0.90
1400.0	16.93	23.83	6.14	22.81	1.08	1.01	35.87	19.48	19.56	1800.0	0.98
1600.0	15.94	22.95	6.02	22.28	1.09	1.02	36.19	19.19	19.27	2000.0	0.87
1700.0	15.48	22.49	5.96	22.13	1.09	1.02	36.22	19.34	19.42	2300.0	1.00
1900.0	14.64	21.71	5.93	21.75	1.09	1.02	36.25	19.31	19.39	2500.0	1.05
2100.0	13.89	20.96	5.92	21.70	1.09	1.02	36.63	19.54	19.61	2700.0	1.53
2300.0	13.21	20.25	5.95	21.89	1.09	1.02	37.19	19.59	19.68	3000.0	1.09
2500.0	12.59	19.59	6.06	22.21	1.09	1.01	36.86	19.62	19.71	3200.0	1.04
2700.0	11.72	19.29	5.91	21.38	1.12	1.05	37.28	19.63	19.70	3400.0	1.27
2900.0	11.47	18.41	6.09	21.68	1.09	1.00	37.35	19.64	19.73	3700.0	1.24
3000.0	11.24	18.09	6.18	21.87	1.09	1.00	37.53	19.62	19.71	3900.0	1.40
3200.0	10.79	17.55	6.32	22.20	1.09	0.99	37.73	19.72	19.80	4100.0	1.41
3400.0	10.36	17.02	6.47	22.45	1.09	0.98	37.66	19.62	19.71	4400.0	1.59
3600.0	9.97	16.52	6.60	22.51	1.09	0.97	37.54	19.79	19.87	4600.0	1.60
3800.0	9.57	16.05	6.73	22.42	1.09	0.96	37.76	19.74	19.83	4900.0	1.87
4000.0	9.18	15.63	6.81	21.98	1.09	0.95	38.42	19.88	19.97	5100.0	1.78
4100.0	8.99	15.43	6.83	21.57	1.09	0.95	37.91	19.82	19.91	5300.0	1.80
4300.0	8.59	15.09	6.79	20.39	1.09	0.95	38.32	19.92	19.99	5600.0	2.18
4500.0	8.25	14.73	6.76	19.41	1.10	0.94	37.97	19.77	19.86	5800.0	2.04
4700.0	7.89	14.41	6.84	18.54	1.11	0.93	39.10	20.08	20.17	6000.0	2.16
4900.0	7.34	14.25	7.09	17.53	1.15	0.93	38.58	20.11	20.19	6400.0	2.17
5100.0	7.24	13.71	6.32	17.38	1.08	0.93	39.00	20.18	20.27	6600.0	2.50
5300.0	6.97	13.41	6.09	16.76	1.07	0.94	38.70	20.19	20.30	6800.0	2.57
5400.0	6.82	13.28	6.00	16.43	1.07	0.94	39.49	20.42	20.48	7000.0	3.00
5600.0	6.53	13.01	5.83	15.79	1.07	0.94	39.05	20.40	20.48		
5800.0	6.23	12.77	5.64	15.20	1.06	0.94	37.76	20.20	20.26		
6000.0	5.92	12.56	5.52	14.69	1.06	0.94	38.39	20.05	20.13		
6200.0	5.65	12.33	5.30	14.20	1.05	0.95	39.65	20.14	20.23		
6400.0	5.38	12.11	5.12	13.77	1.05	0.95	38.93	20.14	20.23		
6600.0	5.10	11.94	4.96	13.33	1.05	0.95	38.41	20.35	20.43		
6800.0	4.80	11.81	4.84	12.93	1.05	0.96	38.83	20.25	20.33		
7000.0	4.44	11.73	4.81	12.40	1.07	0.96	40.47	20.43	20.52		

(1) External Rbias resistor is adjusted to obtain desired current

(2) Current is externally limited during P1dB measurements. Unit is capable of higher output power if current is not limited.

## Typical Performance Data

### Definitions:

Input Return Loss = -S11 (dB)

Gain(Power Gain) = S21 (dB)

Reverse Isolation = -S12 (dB)

Output Return Loss = -S22 (dB)

TEST CONDITIONS: Vd = 3V, Id=74mA @ Temperature = +25degC (1)

FREQ	Gain	Isolation	Input Return Loss	Output Return Loss	Stability		IP-3 Output	1dB Comp. Output (2)		FREQ	Noise Figure
								Current Limit 70mA	Current Limit 80mA		
(MHz)	(dB)	(dB)	(dB)	(dB)	K	Measure	(dBm)	(dBm)		(MHz)	(dB)
50.0	26.23	32.45	11.22	12.41	1.13	0.78	33.92	19.42	19.50	50.0	1.01
100.0	26.05	30.99	11.81	17.65	1.07	0.75	34.02	19.01	19.10	100.0	0.73
300.0	24.89	30.07	9.91	24.02	1.07	0.81	34.24	19.08	19.16	400.0	0.60
500.0	23.31	28.87	8.38	24.72	1.06	0.87	34.71	19.15	19.23	600.0	0.66
600.0	22.49	28.25	7.84	24.44	1.06	0.90	35.11	19.22	19.30	800.0	0.71
800.0	20.92	27.02	7.14	23.72	1.07	0.94	35.46	19.18	19.27	1100.0	0.77
1000.0	19.50	25.95	6.72	22.91	1.08	0.96	35.86	19.14	19.23	1300.0	0.84
1200.0	18.23	24.87	6.44	22.20	1.08	0.98	35.93	19.34	19.42	1600.0	0.91
1400.0	17.10	23.85	6.24	21.69	1.08	0.99	36.16	19.48	19.56	1800.0	1.03
1600.0	16.11	22.98	6.13	21.24	1.09	1.00	35.90	19.19	19.27	2000.0	0.89
1700.0	15.64	22.54	6.07	21.14	1.09	1.00	35.33	19.34	19.42	2300.0	0.95
1900.0	14.80	21.75	6.02	20.85	1.09	1.00	36.07	19.31	19.39	2500.0	1.07
2100.0	14.05	20.97	6.02	20.83	1.09	1.00	36.31	19.54	19.61	2700.0	1.50
2300.0	13.37	20.25	6.05	21.04	1.09	1.00	36.48	19.59	19.68	3000.0	1.11
2500.0	12.75	19.58	6.17	21.35	1.09	0.99	36.01	19.62	19.71	3200.0	1.21
2700.0	11.86	19.25	6.01	20.85	1.12	1.03	36.32	19.63	19.70	3400.0	1.14
2900.0	11.62	18.37	6.20	20.95	1.09	0.98	36.69	19.64	19.73	3700.0	1.32
3000.0	11.39	18.07	6.29	21.18	1.09	0.98	36.51	19.62	19.71	3900.0	1.40
3200.0	10.94	17.49	6.43	21.53	1.08	0.97	36.70	19.72	19.80	4100.0	1.32
3400.0	10.51	16.96	6.58	21.81	1.08	0.95	35.90	19.62	19.71	4400.0	1.58
3600.0	10.11	16.45	6.72	21.94	1.08	0.94	35.92	19.79	19.87	4600.0	1.62
3800.0	9.71	16.00	6.86	21.95	1.08	0.93	36.27	19.74	19.83	4900.0	1.99
4000.0	9.32	15.58	6.92	21.54	1.09	0.93	37.11	19.88	19.97	5100.0	1.80
4100.0	9.12	15.39	6.94	21.20	1.09	0.93	36.11	19.82	19.91	5300.0	1.89
4300.0	8.72	15.03	6.91	20.13	1.09	0.93	37.20	19.92	19.99	5600.0	2.20
4500.0	8.39	14.66	6.87	19.18	1.09	0.92	36.06	19.77	19.86	5800.0	2.19
4700.0	8.02	14.35	6.95	18.30	1.10	0.91	36.45	20.08	20.17	6000.0	2.23
4900.0	7.48	14.18	7.20	17.26	1.14	0.91	36.50	20.11	20.19	6400.0	2.42
5100.0	7.37	13.67	6.41	17.11	1.08	0.91	37.01	20.18	20.27	6600.0	2.54
5300.0	7.10	13.36	6.18	16.52	1.07	0.92	36.21	20.19	20.30	6800.0	2.55
5400.0	6.95	13.22	6.10	16.19	1.07	0.91	37.49	20.42	20.48	7000.0	2.91
5600.0	6.65	12.96	5.91	15.58	1.06	0.92	36.51	20.40	20.48		
5800.0	6.36	12.72	5.72	15.02	1.06	0.92	35.34	20.20	20.26		
6000.0	6.05	12.50	5.61	14.50	1.06	0.92	35.99	20.05	20.13		
6200.0	5.78	12.28	5.39	14.04	1.05	0.93	36.73	20.14	20.23		
6400.0	5.51	12.07	5.20	13.59	1.05	0.93	36.02	20.14	20.23		
6600.0	5.22	11.89	5.05	13.15	1.05	0.93	35.69	20.35	20.43		
6800.0	4.93	11.75	4.91	12.76	1.05	0.94	36.26	20.25	20.33		
7000.0	4.57	11.68	4.88	12.23	1.07	0.94	36.78	20.43	20.52		

(1) External Rbias resistor is adjusted to obtain desired current

(2) Current is externally limited during P1dB measurements. Unit is capable of higher output power if current is not limited.

## Typical Performance Curves

**GAIN vs. FREQUENCY & TEMPERATURE**

Vd = 3V, Rbias=681 ohms

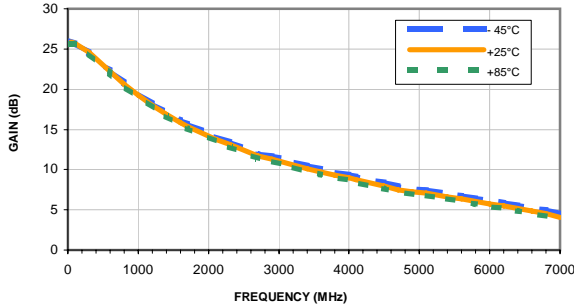

**NOISE FIGURE vs. FREQUENCY & TEMPERATURE**

Vd = 3V, Rbias=681 ohms

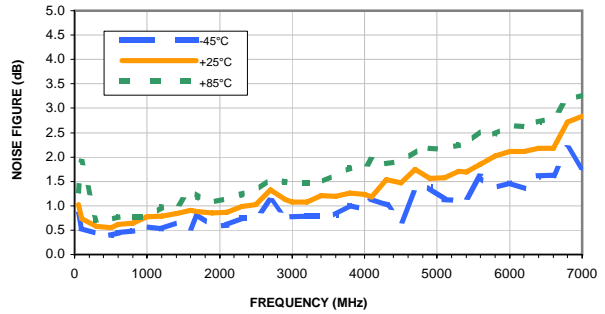

**INPUT RETURN LOSS vs. FREQUENCY & TEMPERATURE**

Vd = 3V, Rbias=681 ohms

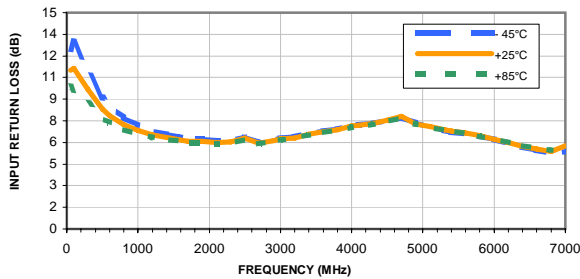

**OUTPUT RETURN LOSS vs. FREQUENCY & TEMPERATURE**

Vd = 3V, Rbias=681 ohms

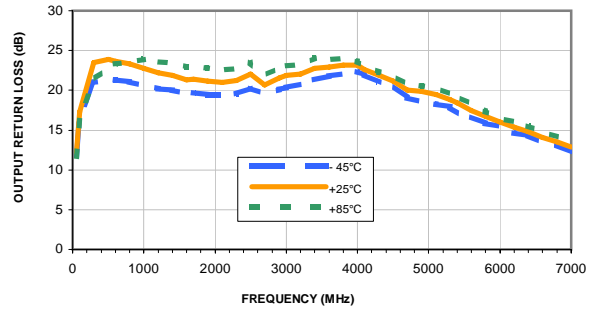

**OUTPUT IP3 vs. FREQUENCY & TEMPERATURE**

Vd = 3V, Rbias=681 ohms

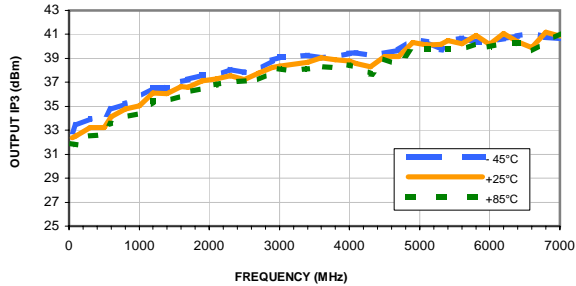

**ISOLATION vs. FREQUENCY & TEMPERATURE**

Vd = 3V, Rbias=681 ohms

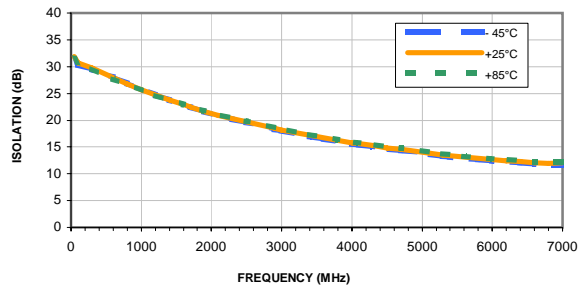

## Typical Performance Curves

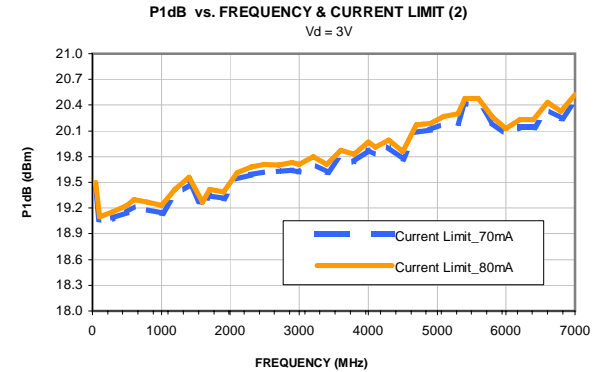
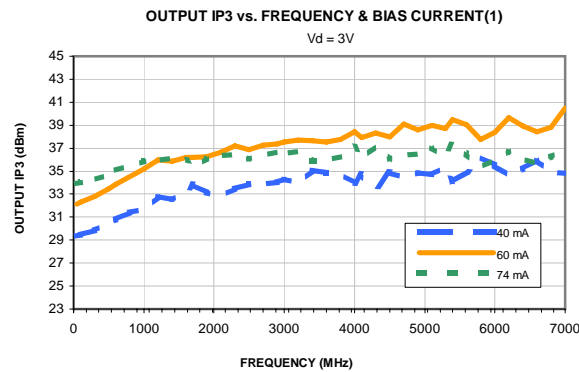
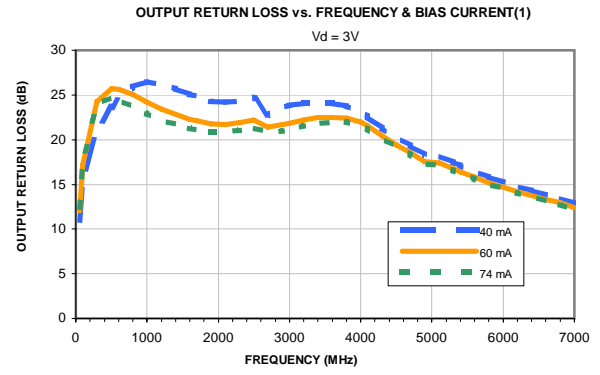
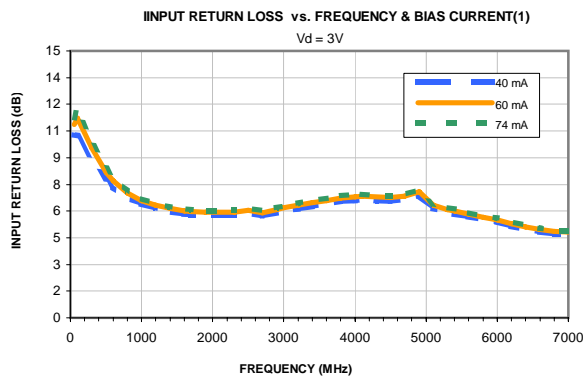
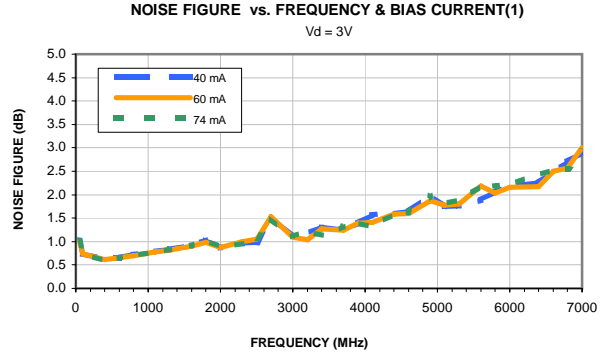
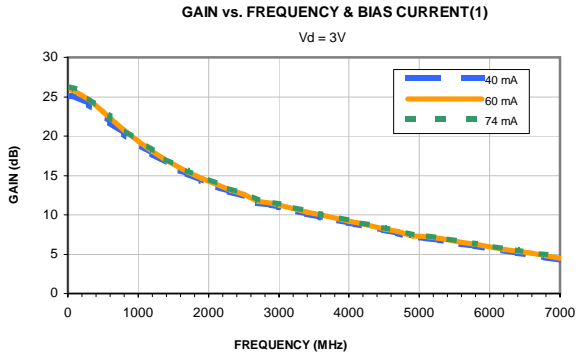

- (1) External Rbias resistor is adjusted to obtain desired current
- (2) Current is externally limited during P1dB measurements. Unit is capable of higher output power if current is not limited.

### Outline Dimensions

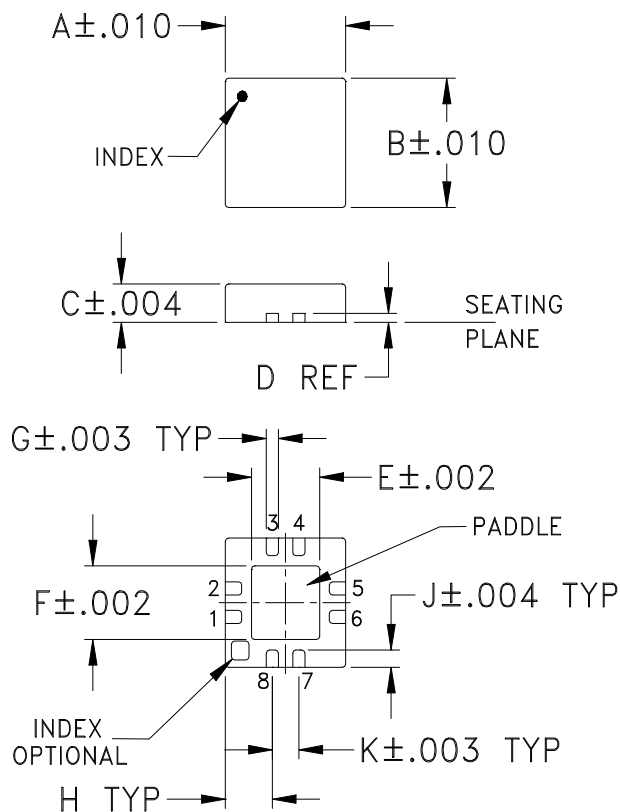

### PCB Land Pattern

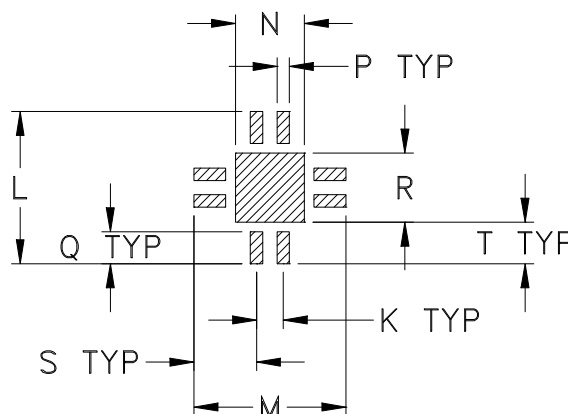

Suggested Layout,  
Tolerance to be within  $\pm.002$

CASE #	A	B	C	D	E	F	G	H	J	K	L	M	N
DQ849	.118 (3.00)	.118 (3.00)	.035 (0.89)	.008 (0.20)	.067 (1.70)	.067 (1.70)	.012 (0.30)	.046 (1.17)	.016 (0.41)	.026 (0.66)	.148 (3.76)	.148 (3.76)	.067 (1.70)

CASE #	P	Q	R	S	T	WT. GRAM
DQ849	.012 (0.30)	.031 (0.79)	.067 (1.70)	.061 (1.55)	.041 (1.04)	.02

Dimensions are in inches (mm). Tolerances: 2Pl.  $\pm.01$ ; 3 Pl.  $\pm.004$

#### Notes:

- Case material: Plastic.
- Termination finish:  
 For RoHS Case Styles: Tin-Silver alloy plate over Nickel barrier or Matte-Tin plated. All models, (+) suffix. See Data sheet.  
 For RoHS-5 Case Styles: Tin-Lead plate. All models. no (+) suffix.



INTERNET <http://www.minicircuits.com>

P.O. Box 350166, Brooklyn, New York 11235-0003 (718) 934-4500 Fax (718) 332-4661

Distribution Centers NORTH AMERICA 800-654-7949 • 417-335-5935 • Fax 417-335-5945 • EUROPE 44-1252-832600 • Fax 44-1252-837010

Mini-Circuits ISO 9001 & ISO 14001 Certified

# Tape & Reel Packaging TR-F104

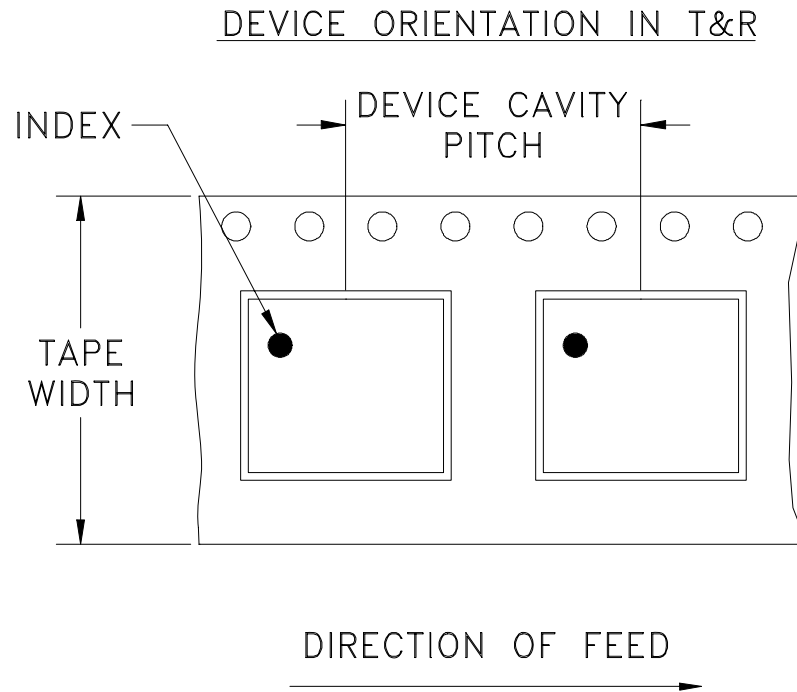

Tape Width, mm	Device Cavity Pitch, mm	Reel Size, inches	Devices per Reel	
8	4	7	Small quantity standards (see note)	20
				50
				100
				200
				500
				1000
		7	Standard	2000

Note: Please Consult individual model data sheet to determine device per reel availability.

Mini-Circuits carrier tape materials provide protection from ESD (Electro-Static Discharge) during handling and transportation. Tapes are static dissipative and comply with industry standards EIA-481/EIA-541.

Go to: [www.minicircuits.com/pages/pdfs/tape.pdf](http://www.minicircuits.com/pages/pdfs/tape.pdf)



INTERNET <http://www.minicircuits.com>

P.O. Box 350166, Brooklyn, New York 11235-0003 (718) 934-4500 Fax (718) 332-4661

Distribution Centers NORTH AMERICA 800-654-7949 • 417-335-5935 • Fax 417-335-5945 • EUROPE 44-1252-832600 • Fax 44-1252-837010

Mini-Circuits ISO 9001 & ISO 14001 Certified

THIRD ANGLE PROJECTION

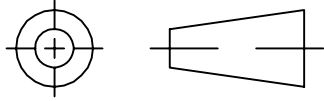

REVISIONS

REV	ECN No.	DESCRIPTION	DATE	DR	AUTH
OR	M121752	NEW RELEASE	03/05/09	PW	TH
A	M129864	ADDED DIMENSIONS	12/14/10	MMG	MM
B	M137913	REMOVED COMPONENT VALUES	07/10/12	GF	DJ

SUGGESTED MOUNTING CONFIGURATION FOR  
DQ849 CASE STYLES  
"08AM01" PIN CONNECTION

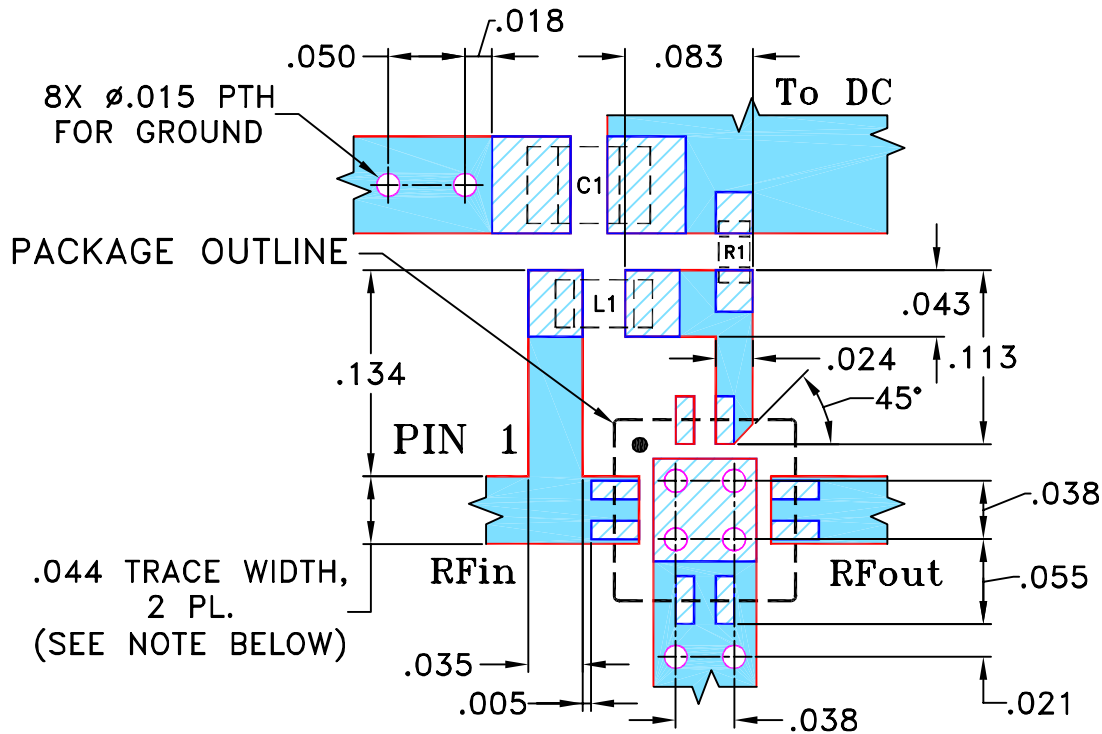

RESISTOR R1: 0402 SIZE  
INDUCTOR L1: 0603 SIZE  
CAPACITOR C1: 0805 SIZE

NOTES:

1. TRACE WIDTH IS SHOWN FOR ROGERS R04350B WITH DIELECTRIC THICKNESS  $.020" \pm .0015"$ ; COPPER: 1/2 OZ. EACH SIDE. FOR OTHER MATERIALS TRACE WIDTH MAY NEED TO BE MODIFIED.
2. R1, L1 AND C1 FOOTPRINTS SHOWN FOR REFERENCE ONLY.
3. BOTTOM SIDE OF THE PCB IS CONTINUOUS GROUND PLANE.

DENOTES PCB COPPER LAYOUT WITH SMOBC (SOLDER MASK OVER BARE COPPER).

DENOTES COPPER LAND PATTERN FREE OF SOLDER MASK.

UNLESS OTHERWISE SPECIFIED	INITIALS	DATE
DIMENSIONS ARE IN INCHES TOLERANCES ON: 2 PL DECIMALS $\pm$ 3 PL DECIMALS $\pm$ .005 ANGLES $\pm$ 1° FRACTIONS $\pm$	DRAWN	PW 02/26/09
	CHECKED	IL 03/04/09
	APPROVED	TH 03/05/09

Mini-Circuits® 13 Neptune Avenue  
Brooklyn NY 11235

PL, 08AM01, DQ849, TB-501(-X)+

SIZE	CODE IDENT	DRAWING NO:	REV:
A	15542	98-PL-299	B
FILE:	98PL299	SCALE: 8:1	SHEET: 1 OF 1

Mini-Circuits®  
THIS DOCUMENT AND ITS CONTENTS ARE THE PROPERTY OF MINI-CIRCUITS. EXCEPT FOR USE EXPRESSLY GRANTED, IN WRITING, TO ITS VENDORS, VENDEE AND THE UNITED STATES GOVERNMENT, MINI-CIRCUITS RESERVES ALL PROPRIETARY DESIGN, USE, MANUFACTURING AND REPRODUCTION RIGHTS THERETO. THESE CONTENTS SHALL NOT BE USED, DUPLICATED OR DISCLOSED TO ANY OUTSIDE PARTY, IN WHOLE OR IN PART, WITHOUT WRITTEN PERMISSION OF MINI-CIRCUITS.



# Evaluation Board and Circuit

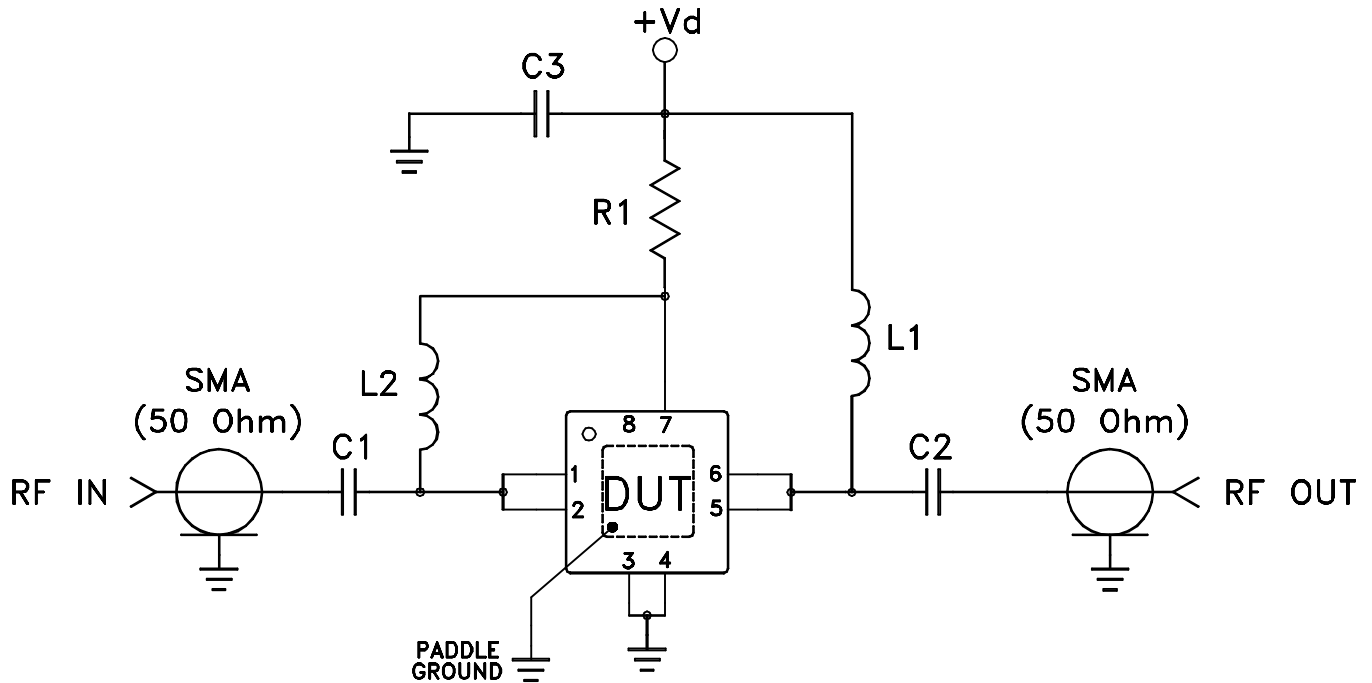
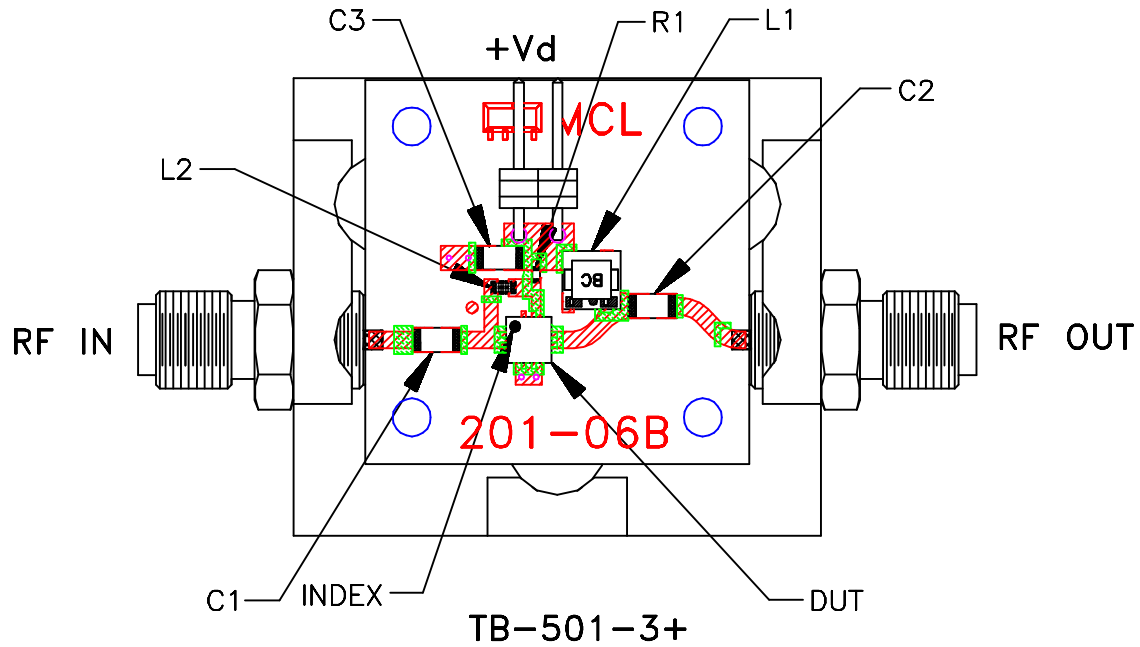

COMPONENT	VALUE/PART NUMBER
DUT	Mini-Circuits PMA-5453+
C1, C2, C3	0.1 uF
L1	Mini-Circuits TCCH-80+
L2	390 nH
R1	681 Ohm

## Notes:

- 50 Ohm SMA Female connectors.
- PCB Material: R04350 or equivalent,  
Dielectric Constant=3.5, Thickness=.020 inch.

## Schematic Diagram

 **Mini-Circuits®**

All Mini-Circuits products are manufactured under exacting quality assurance and control standards, and are capable of meeting published specifications after being subjected to any or all of the following physical and environmental test.

Specification	Test/Inspection Condition	Reference/Spec
Operating Temperature	-40° to 85° C or -45° to 85° C or -55° to 105° C or -40° to 105° C or -40° to 95° C Ambient Environment	Individual Model Data Sheet
Storage Temperature	-55° to 100° C or -65° to 150° Ambient Environment	Individual Model Data Sheet
HTOL	1000 hours at 125°C	MIL-STD-883, Method 1005, Condition B
Thermal Shock	-55° to 100°C, 100 cycles	MIL-STD-202, Method 107, Condition A-3, except +100°C
Mechanical Shock	1.5Kg, 0.5 ms, 5 shock pulses, Y1 direction only	MIL-STD-883, Method 2002, Condition B, except Y1 direction only
Vibration (Variable Frequency)	50g peak	MIL-STD-883, Method 2007, Condition B
Autoclave	15 psig, 100% RH, 121°C, 96 hours	JESD22-A102, Condition C
HAST	130°C, 85% RH, 96 hours	JESD22-A110
Solderability	10X Magnification	J-STD-002, Para 4.2.5, Test S, 95% Coverage
Solder Reflow Heat	Sn-Pb Eutetic Process: 240°C peak Pb-Free Process: 260°C peak	J-STD-020, Table 4-1, 4-2 and 5-2; Figure 5-1
Moisture Sensitivity: Level 1	Bake at 125°C for 24 hours Soak at 85°C/85% RH for 168 hours, Reflow 3 cycles at 260°C peak	J-STD-020



All Mini-Circuits products are manufactured under exacting quality assurance and control standards, and are capable of meeting published specifications after being subjected to any or all of the following physical and environmental test.

Specification	Test/Inspection Condition	Reference/Spec
Marking Resistance to Solvents	Isopropyl alcohol + mineral spirits at 25°C; terpene defluxer at 25°C; distilled water + proylene glycol monomethyl ether + monoethanolamine at 63°C to 70°C	MIL-STD-202, Method 215