



ULTRA HIGH DYNAMIC RANGE

Monolithic Amplifier

PHA-23LN+

50Ω 30 MHz to 2 GHz

THE BIG DEAL

- Ultra-High IP3, +37.4 dBm typ. at 1 GHz
- Low supply voltage, +3 to +5V
- Excellent Noise Figure, 1.2 dB typ. at 1 GHz
- Gain, 21 dB at 1 GHz

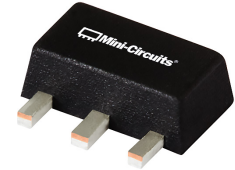

Generic photo used for illustration purposes only

CASE STYLE: DF782

+RoHS Compliant

The +Suffix identifies RoHS Compliance. See our website for methodologies and qualifications

APPLICATIONS

- Base station infrastructure
- CATV
- Cellular

PRODUCT OVERVIEW

PHA-23LN+ (RoHS compliant) is an advanced wideband amplifier fabricated using E-PHEMT technology and offers extremely high dynamic range over a broad frequency range and with low noise figure. In addition, the PHA-23LN+ has good input and output return loss over a broad frequency range. PHA-23LN+ is enclosed in a SOT-89 package and has very good thermal performance.

KEY FEATURES

Feature	Advantages
Broad Band: 30 MHz to 2 GHz	Broadband covering primary wireless communications bands: VHF, UHF, Cellular
Extremely High IP3 +40.9 dBm typical at 30 MHz +37.4 dBm typical at 1 GHz	The PHA-23LN+ matches industry leading IP3 performance relative to device size and power consumption. The combination of the design and E-PHEMT Structure provides enhanced linearity over a broad frequency range as evidence in the IP3 being approximately 13-18 dB above the P1dB point. This feature makes this amplifier ideal for use in: <ul style="list-style-type: none"> • Driver amplifiers for complex waveform up converter paths • Drivers in linearized transmit systems • Secondary amplifiers in ultra-High Dynamic range receivers
Low Noise Figure 1.2 dB at 1 GHz	Enables lower system noise figure performance and along with High OIP3 provides high dynamic range
Low Supply Voltage	PHA-23LN+ supports low supply voltage operation which indicate low power consumption.

REV. B
ECO-010399
PHA-23LN+
MCL NY
240722





ULTRA HIGH DYNAMIC RANGE

Monolithic Amplifier

PHA-23LN+

50Ω 30 MHz to 2 GHz

ELECTRICAL SPECIFICATIONS¹ AT +25°C, 50Ω, UNLESS NOTED OTHERWISE

Parameter	Condition (MHz)	Vd=+5V ¹			Vd=+3V ¹	Units
		Min.	Typ.	Max.	Typ.	
Frequency Range		30		2000	30-2000	MHz
Gain	30	—	23.0	—	22.3	dB
	500	—	21.9	—	21.0	
	1000	18.9	21.0	23.1	19.7	
	1500	18.1	20.1	22.1	18.5	
	2000	—	18.9	—	17.0	
Input Return Loss	30		12.0		12.4	dB
	500		11.6		10.5	
	1000		9.4		7.5	
	1500		9.6		7.7	
	2000		8.9		6.9	
Output Return Loss	30		14.9		16.6	dB
	500		16.5		21.0	
	1000		18.8		18.0	
	1500		12.2		10.8	
	2000		9.4		8.5	
Reverse Isolation	1000		27.2		26.9	dB
Output Power @1 dB compression	30		+22.8		+17.4	dBm
	500		+24.1		+19.0	
	1000		+23.9		+18.8	
	1500		+23.4		+18.4	
	2000		+23.3		+18.0	
Output IP3 ²	30		+40.9		+34.7	dBm
	500		+39.3		+33.3	
	1000		+37.4		+30.9	
	1500		+36.3		+30.5	
	2000		+35.6		+29.7	
Noise Figure	30		1.1		1.1	dB
	500		1.0		1.0	
	1000		1.2		1.2	
	1500		1.3		1.3	
	2000		1.6		1.6	
Device Operating Voltage			+5.0		+3.0	V
Device Operating Current			141.7	162	72.4	mA
Device Current Variation vs. Temperature ³			14.2		33.1	μA/°C
Device Current Variation vs Voltage			0.0354		0.0354	mA/mV
Thermal Resistance, Junction-to-ground lead at 85°C stage temperature			23.3		23.3	°C/W

1. Measured on Mini-Circuits Characterization test board TB-951-23LN+. See Characterization Test Circuit (Fig. 1)

2. Tested at Pout= 0 dBm / tone.

3. (Current at 85°C – Current at -45°C)/130



ULTRA HIGH DYNAMIC RANGE

Monolithic Amplifier

PHA-23LN+

50Ω 30 MHz to 2 GHz

ABSOLUTE MAXIMUM RATINGS⁴

Parameter	Ratings
Operating Temperature (ground lead)	-40°C to +105°C
Storage Temperature	-65°C to +150°C
Power Dissipation ⁵	3.3 W
Input Power (CW)	+22 dBm (5 minutes max) ⁶ +4 dBm (continuous) for 0.03-1GHz at +3V +8 dBm (continuous) for 0.03-1GHz at +5V +12 dBm (continuous) for 1-2GHz at +3V +15 dBm (continuous) for 1-2GHz at +5V
DC Voltage on Pin 3	+10 V

4. Permanent damage may occur if any of these limits are exceeded. Electrical maximum ratings are not intended for continuous normal operation.

5. Up to 85°C, derate linearly to 2.5 W at 105°C.

6. Up to 85°C, derate linearly to +19 dBm at 105°C.

SIMPLIFIED SCHEMATIC AND PIN DESCRIPTION

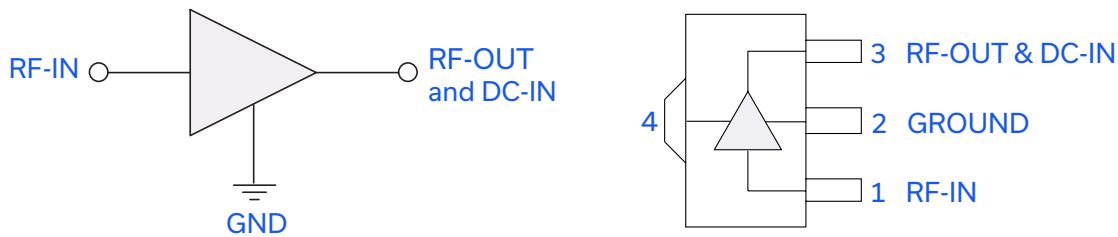

Function	Pin Number	Description
RF IN	1	RF Input
RF-OUT and DC-IN	3	RF Output and DC Bias
GND	2,4	Connections to ground.



ULTRA HIGH DYNAMIC RANGE

Monolithic Amplifier

PHA-23LN+

50Ω 30 MHz to 2 GHz

CHARACTERIZATION TEST / RECOMMENDED APPLICATION CIRCUIT

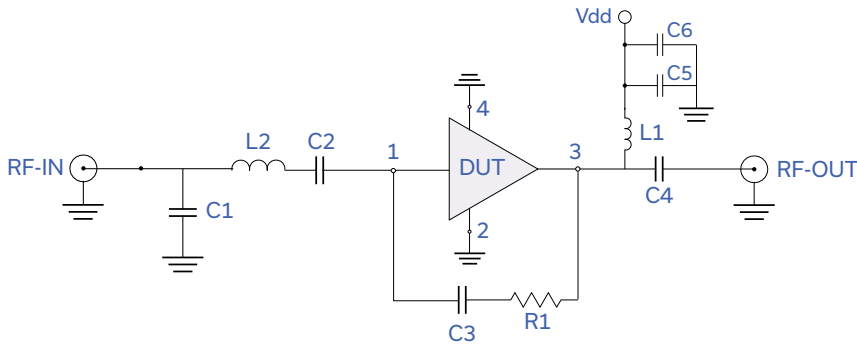

Component	Size	Value	Manufacturer	P/N
C1	0402	1.2pF	Murata	GRM1555C1H1R2WA01D
C2,C3,C6		0.1uF		GRM155R71C104KA88D
C4		0.001uF		GRM1555C1H102JA01D
C5		0.01uF		GRM155R71E103KA01D
R1		1.21KOhm		KOA
L1	0805	0.68uH	Coilcraft	0805LS-681XJLB
L2	0402	1nH		0402CS-1N0XJLW

Fig 1. Block Diagram of Test Circuit used for characterization. (DUT soldered on Mini-Circuits Characterization test board TB-951-23LN+) Gain, Return loss, Output power at 1dB compression (P1 dB), output IP3 (OIP3) and noise figure measured using Agilent's N5242A PNA-X microwave network analyzer.

Conditions:

1. Gain and Return loss: $P_{IN} = -25dBm$
2. Output IP3 (OIP3): Two tones, spaced 1 MHz apart, 0 dBm/ tone at output.

PRODUCT MARKING

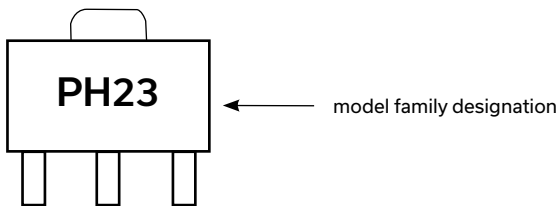

Marking may contain other features or characters for internal lot control





ULTRA HIGH DYNAMIC RANGE

Monolithic Amplifier

PHA-23LN+

50Ω 30 MHz to 2 GHz

ADDITIONAL DETAILED TECHNICAL INFORMATION IS AVAILABLE ON OUR DASHBOARD. [CLICK HERE](#)

Performance Data	Data Table Swept Graphs S-Parameter (S2P Files) Data Set (.zip file)
Case Style	DF782 (SOT 89) Plastic package, exposed paddle lead finish: matte-tin
Tape & Reel Standard quantities available on reel	F55 7" reels with 20, 50, 100, 200, 500 or 1K devices
Suggested Layout for PCB Design	PL-512
Evaluation Board	TB-951-23LN+
Environmental Ratings	ENV08T9

ESD RATING

Human Body Model (HBM): Class 1B (Pass 500 V) in accordance with ANSI/ESD STM 5.1 - 2001

MSL RATING

Moisture Sensitivity: MSL1 in accordance with IPC/JEDEC J-STD-020D

- NOTES**
- A. Performance and quality attributes and conditions not expressly stated in this specification document are intended to be excluded and do not form a part of this specification document.
 - B. Electrical specifications and performance data contained in this specification document are based on Mini-Circuit's applicable established test performance criteria and measurement instructions.
 - C. The parts covered by this specification document are subject to Mini-Circuits standard limited warranty and terms and conditions (collectively, "Standard Terms"); Purchasers of this part are entitled to the rights and benefits contained therein. For a full statement of the standard. Terms and the exclusive rights and remedies thereunder, please visit Mini-Circuits' website at www.minicircuits.com/MCLStore/terms.jsp



Typical Performance Data

NOTE: Use PDF Bookmarks to view DATA at required conditions

Definitions:

Input Return Loss = -S11 (dB)

Gain(Power Gain) = S21 (dB)

Reverse Isolation = -S12 (dB)

Output Return Loss = -S22 (dB)

TEST CONDITIONS: Vd = 3.00V, Id = 71.08mA @ Temperature = +25°C

FREQ	Gain	Isolation	Input Return Loss	Output Return Loss	Stability		IP-3 Output	1dB Comp. Output	Noise Figure
					K	Measure			
(MHz)	(dB)	(dB)	(dB)	(dB)	K	Measure	(dBm)	(dBm)	(dB)
20	22.70	26.01	10.64	15.59	1.03	0.54	32.50	15.45	1.08
30	22.40	25.47	12.17	16.17	1.03	0.51	33.73	16.92	1.02
40	22.19	25.22	13.05	15.61	1.03	0.49	34.84	18.03	1.00
50	22.04	25.07	13.58	15.23	1.03	0.48	34.62	18.50	0.96
60	21.97	25.01	13.99	15.06	1.04	0.48	34.80	18.62	1.01
70	21.90	24.96	14.21	14.94	1.04	0.47	34.73	18.67	0.98
80	21.86	24.93	14.35	14.85	1.04	0.47	34.41	18.78	0.94
90	21.83	24.91	14.41	14.82	1.04	0.47	34.24	18.85	1.04
100	21.80	24.90	14.45	14.79	1.04	0.48	34.33	18.76	0.96
150	21.71	24.90	14.20	14.92	1.05	0.49	34.31	18.91	0.94
200	21.63	24.94	13.75	15.24	1.05	0.51	34.49	18.99	0.93
250	21.55	25.00	13.13	15.67	1.05	0.53	34.32	19.06	0.96
300	21.46	25.07	12.48	16.19	1.05	0.56	34.58	19.00	0.97
350	21.37	25.17	11.88	16.84	1.06	0.59	34.24	19.05	0.96
400	21.26	25.27	11.30	17.61	1.06	0.63	33.90	18.95	1.00
450	21.14	25.37	10.76	18.64	1.07	0.66	33.55	18.94	0.98
500	21.03	25.49	10.25	19.82	1.07	0.70	33.31	18.82	1.03
550	20.90	25.62	9.83	21.40	1.08	0.73	33.16	18.72	1.08
600	20.78	25.76	9.43	23.22	1.08	0.77	32.66	18.84	1.22
650	20.64	25.90	9.06	25.45	1.09	0.80	32.37	18.60	1.14
700	20.50	26.05	8.72	27.37	1.10	0.84	32.07	18.73	1.10
750	20.35	26.21	8.44	28.09	1.11	0.87	31.88	18.71	1.14
800	20.20	26.37	8.19	26.42	1.12	0.90	31.75	18.67	1.09
850	20.06	26.51	7.96	24.28	1.12	0.92	31.34	18.36	1.17
900	19.93	26.65	7.77	22.17	1.13	0.94	31.25	18.39	1.15
950	19.80	26.78	7.61	20.41	1.14	0.96	31.15	18.72	1.15
1000	19.66	26.92	7.46	18.89	1.15	0.98	30.87	18.68	1.21
1100	19.40	27.17	7.30	16.41	1.16	1.01	30.78	18.29	1.16
1200	19.14	27.38	7.22	14.56	1.18	1.02	30.44	18.45	1.24
1300	18.89	27.56	7.25	13.17	1.19	1.03	30.44	18.46	1.27
1400	18.65	27.72	7.35	12.05	1.21	1.03	30.23	18.17	1.32
1500	18.42	27.83	7.48	11.16	1.22	1.02	29.91	18.22	1.33
1600	18.18	27.97	7.59	10.43	1.23	1.02	29.86	18.10	1.42
1700	17.92	28.07	7.61	9.84	1.24	1.02	29.41	18.03	1.40
1800	17.62	28.21	7.46	9.39	1.25	1.03	29.55	17.80	1.45
1900	17.26	28.41	7.12	9.04	1.26	1.05	29.46	17.72	1.52
2000	16.83	28.64	6.57	8.77	1.28	1.08	29.11	17.69	1.61
2100	16.33	28.92	5.87	8.56	1.29	1.12	28.97	17.58	1.75
2200	15.76	29.28	5.13	8.40	1.30	1.16	28.50	17.51	1.96
2300	15.09	29.69	4.43	8.30	1.33	1.21	28.50	17.25	2.14
2400	14.38	30.19	3.80	8.19	1.36	1.26	28.12	17.06	2.33
2500	13.60	30.71	3.25	8.11	1.40	1.30	28.37	17.03	2.60

Typical Performance Data

Definitions:

Input Return Loss = -S11 (dB)

Gain(Power Gain) = S21 (dB)

Reverse Isolation = -S12 (dB)

Output Return Loss = -S22 (dB)

TEST CONDITIONS: Vd = 5.00V, Id = 140.45mA @ Temperature = +25°C

FREQ	Gain	Isolation	Input Return Loss	Output Return Loss	Stability		IP-3 Output	1dB Comp. Output	Noise Figure
					K	Measure			
(MHz)	(dB)	(dB)	(dB)	(dB)	K	Measure	(dBm)	(dBm)	(dB)
20	23.44	26.53	10.57	14.50	1.02	0.50	41.12	21.53	1.11
30	23.09	26.02	11.72	14.37	1.02	0.47	42.41	22.57	1.05
40	22.86	25.79	12.27	13.76	1.03	0.45	44.43	23.27	1.01
50	22.70	25.70	12.51	13.40	1.03	0.45	41.45	23.62	0.99
60	22.63	25.60	12.84	13.25	1.03	0.44	43.59	23.61	1.02
70	22.56	25.56	12.97	13.13	1.03	0.44	42.21	23.57	0.97
80	22.52	25.53	13.05	13.04	1.04	0.44	41.75	23.68	0.95
90	22.48	25.51	13.09	13.01	1.04	0.44	42.44	23.77	0.97
100	22.46	25.50	13.14	12.97	1.04	0.44	41.75	23.62	0.96
150	22.37	25.48	13.11	13.03	1.04	0.45	41.89	23.76	1.03
200	22.32	25.51	13.00	13.21	1.04	0.46	41.89	23.90	0.92
250	22.26	25.56	12.76	13.46	1.05	0.48	41.65	24.01	0.96
300	22.20	25.61	12.48	13.75	1.05	0.50	41.62	23.95	0.96
350	22.14	25.68	12.22	14.10	1.05	0.52	41.29	24.03	0.94
400	22.07	25.76	11.92	14.50	1.06	0.54	40.45	23.93	1.03
450	21.99	25.84	11.63	15.02	1.07	0.57	39.94	23.97	1.01
500	21.92	25.94	11.34	15.58	1.07	0.60	39.54	23.83	1.03
550	21.84	26.03	11.08	16.28	1.08	0.62	39.49	23.73	1.05
600	21.77	26.14	10.83	17.01	1.08	0.65	38.80	23.91	1.43
650	21.68	26.26	10.59	17.83	1.09	0.68	38.62	23.60	1.18
700	21.58	26.39	10.35	18.58	1.10	0.71	38.47	23.82	1.11
750	21.49	26.53	10.15	19.34	1.11	0.73	38.00	23.80	1.13
800	21.39	26.67	9.97	19.88	1.12	0.76	37.92	23.73	1.08
850	21.30	26.82	9.81	20.36	1.13	0.78	37.26	23.36	1.15
900	21.21	26.95	9.64	20.47	1.14	0.80	37.00	23.38	1.12
950	21.12	27.09	9.50	20.27	1.15	0.82	37.50	23.85	1.12
1000	21.03	27.23	9.38	19.74	1.16	0.84	37.84	23.79	1.18
1100	20.85	27.53	9.23	18.13	1.19	0.87	36.59	23.23	1.12
1200	20.66	27.83	9.19	16.42	1.21	0.89	36.56	23.48	1.23
1300	20.48	28.12	9.24	14.95	1.24	0.91	36.35	23.50	1.25
1400	20.31	28.40	9.38	13.72	1.27	0.91	35.73	23.00	1.28
1500	20.13	28.65	9.58	12.70	1.30	0.92	35.78	23.11	1.29
1600	19.95	28.93	9.77	11.85	1.33	0.93	35.61	23.07	1.35
1700	19.77	29.17	9.86	11.15	1.35	0.93	35.18	23.02	1.35
1800	19.54	29.43	9.73	10.59	1.37	0.95	35.06	22.83	1.38
1900	19.27	29.73	9.32	10.13	1.40	0.97	35.04	22.80	1.49
2000	18.94	30.06	8.59	9.75	1.42	1.00	34.93	22.91	1.53
2100	18.55	30.40	7.62	9.42	1.43	1.04	34.81	22.81	1.70
2200	18.09	30.81	6.62	9.14	1.44	1.09	34.83	22.94	1.85
2300	17.53	31.22	5.66	8.93	1.45	1.14	34.24	22.42	2.02
2400	16.93	31.73	4.80	8.69	1.47	1.19	33.82	22.12	2.19
2500	16.24	32.21	4.06	8.49	1.48	1.24	34.27	22.35	2.43

Typical Performance Data

Definitions:

Input Return Loss = -S11 (dB)

Gain(Power Gain) = S21 (dB)

Reverse Isolation = -S12 (dB)

Output Return Loss = -S22 (dB)

TEST CONDITIONS: Vd = 2.70V, Id =62.12mA @ Temperature = +25°C

FREQ	Gain	Isolation	Input Return Loss	Output Return Loss	Stability		IP-3 Output	1dB Comp. Output	Noise Figure
					K	Measure			
(MHz)	(dB)	(dB)	(dB)	(dB)	K	Measure	(dBm)	(dBm)	(dB)
20	22.38	25.80	10.61	15.92	1.04	0.55	30.39	14.45	1.08
30	22.11	25.25	12.37	17.09	1.03	0.52	32.42	15.91	1.03
40	21.92	24.99	13.45	16.71	1.04	0.50	33.29	17.02	1.00
50	21.79	24.89	14.19	16.42	1.04	0.50	33.06	17.49	0.96
60	21.72	24.78	14.64	16.26	1.04	0.49	33.12	17.62	1.00
70	21.66	24.74	14.93	16.14	1.04	0.49	33.18	17.66	0.99
80	21.63	24.71	15.09	16.06	1.04	0.49	32.95	17.77	0.97
90	21.59	24.69	15.18	16.04	1.04	0.49	32.74	17.86	0.94
100	21.57	24.68	15.21	16.02	1.04	0.49	32.90	17.75	0.97
150	21.48	24.68	14.87	16.22	1.05	0.50	32.91	17.90	0.97
200	21.40	24.72	14.21	16.61	1.05	0.52	32.89	17.97	0.95
250	21.31	24.79	13.44	17.17	1.05	0.55	32.80	18.04	0.94
300	21.22	24.87	12.68	17.87	1.06	0.58	32.87	17.98	1.03
350	21.12	24.96	11.98	18.78	1.06	0.61	32.38	18.01	0.97
400	21.01	25.07	11.29	19.85	1.06	0.65	32.30	17.89	1.00
450	20.88	25.19	10.67	21.23	1.07	0.68	31.97	17.89	1.02
500	20.76	25.31	10.12	22.85	1.07	0.72	31.42	17.76	1.04
550	20.63	25.45	9.63	24.88	1.08	0.76	31.27	17.65	1.06
600	20.49	25.59	9.19	26.88	1.08	0.79	30.90	17.79	1.09
650	20.35	25.74	8.78	28.14	1.09	0.83	30.60	17.54	1.16
700	20.19	25.90	8.43	27.31	1.10	0.86	30.31	17.67	1.08
750	20.04	26.06	8.14	25.26	1.10	0.89	30.18	17.63	1.11
800	19.88	26.22	7.88	22.90	1.11	0.92	30.09	17.60	1.12
850	19.74	26.37	7.65	20.92	1.12	0.94	29.66	17.28	1.18
900	19.59	26.50	7.45	19.25	1.12	0.96	29.57	17.32	1.14
950	19.46	26.63	7.29	17.87	1.13	0.98	29.54	17.64	1.19
1000	19.31	26.75	7.16	16.71	1.13	0.99	29.36	17.57	1.23
1100	19.04	26.97	7.00	14.75	1.15	1.01	29.18	17.23	1.16
1200	18.77	27.16	6.96	13.22	1.16	1.02	28.86	17.39	1.23
1300	18.52	27.30	7.02	12.03	1.17	1.02	28.93	17.34	1.32
1400	18.28	27.42	7.16	11.05	1.18	1.02	28.65	17.07	1.32
1500	18.03	27.50	7.36	10.26	1.19	1.01	28.36	17.14	1.33
1600	17.79	27.62	7.53	9.62	1.20	1.01	28.35	16.98	1.42
1700	17.53	27.69	7.59	9.10	1.21	1.00	27.92	16.89	1.41
1800	17.22	27.78	7.48	8.73	1.21	1.01	28.03	16.66	1.44
1900	16.85	27.96	7.16	8.42	1.23	1.03	27.93	16.55	1.55
2000	16.40	28.21	6.59	8.25	1.25	1.06	27.61	16.56	1.61
2100	15.88	28.47	5.84	8.11	1.25	1.10	27.46	16.40	1.76
2200	15.27	28.85	5.07	8.04	1.27	1.15	27.09	16.35	1.97
2300	14.56	29.27	4.33	8.01	1.29	1.21	27.04	16.08	2.15
2400	13.81	29.78	3.67	7.98	1.33	1.26	26.68	15.88	2.36
2500	13.00	30.35	3.12	7.94	1.37	1.31	26.92	15.84	2.67

Typical Performance Data

Definitions:

Input Return Loss = -S11 (dB)

Gain(Power Gain) = S21 (dB)

Reverse Isolation = -S12 (dB)

Output Return Loss = -S22 (dB)

TEST CONDITIONS: Vd = 5.25V, Id = 149.05mA @ Temperature = +25°C

FREQ	Gain	Isolation	Input Return Loss	Output Return Loss	Stability		IP-3 Output	1dB Comp. Output	Noise Figure
					K	Measure			
(MHz)	(dB)	(dB)	(dB)	(dB)	K	Measure	(dBm)	(dBm)	(dB)
20	23.48	26.55	10.57	14.48	1.02	0.49	41.55	22.07	1.11
30	23.14	26.05	11.69	14.32	1.02	0.47	42.19	22.98	1.02
40	22.90	25.82	12.21	13.70	1.03	0.45	44.00	23.68	1.01
50	22.74	25.74	12.56	13.34	1.03	0.45	43.81	24.02	0.97
60	22.67	25.63	12.75	13.18	1.03	0.44	43.42	24.03	1.03
70	22.60	25.59	12.88	13.06	1.03	0.44	42.19	23.98	0.96
80	22.56	25.56	12.95	12.98	1.04	0.44	43.21	24.10	0.97
90	22.52	25.54	13.01	12.94	1.04	0.43	42.75	24.18	0.97
100	22.50	25.53	13.05	12.91	1.04	0.44	42.63	24.04	0.97
150	22.42	25.52	13.04	12.96	1.04	0.44	42.08	24.18	0.95
200	22.36	25.55	12.93	13.13	1.04	0.46	42.75	24.32	0.93
250	22.30	25.59	12.72	13.36	1.05	0.47	42.84	24.43	0.94
300	22.24	25.65	12.46	13.62	1.05	0.49	40.75	24.39	0.98
350	22.19	25.71	12.23	13.96	1.05	0.51	41.61	24.46	0.94
400	22.12	25.79	11.94	14.32	1.06	0.54	40.82	24.37	1.04
450	22.05	25.87	11.66	14.80	1.07	0.56	40.36	24.40	0.99
500	21.98	25.97	11.39	15.31	1.07	0.59	40.15	24.27	1.03
550	21.90	26.07	11.15	15.95	1.08	0.62	39.65	24.18	1.05
600	21.83	26.18	10.91	16.59	1.08	0.64	39.63	24.36	1.08
650	21.74	26.29	10.68	17.31	1.09	0.67	39.01	24.05	1.19
700	21.65	26.42	10.46	17.95	1.10	0.70	38.79	24.28	1.06
750	21.56	26.56	10.28	18.58	1.11	0.72	38.56	24.26	1.02
800	21.46	26.71	10.10	19.02	1.12	0.75	38.25	24.21	1.06
850	21.37	26.85	9.93	19.41	1.13	0.77	37.61	23.83	1.14
900	21.29	26.98	9.78	19.51	1.14	0.79	37.36	23.85	1.12
950	21.21	27.13	9.64	19.36	1.15	0.81	37.94	24.33	1.10
1000	21.12	27.28	9.52	18.94	1.17	0.83	38.11	24.27	1.20
1100	20.94	27.58	9.38	17.60	1.19	0.86	36.99	23.72	1.10
1200	20.76	27.89	9.34	16.09	1.22	0.88	37.02	23.95	1.21
1300	20.58	28.20	9.39	14.73	1.25	0.89	36.83	23.97	1.21
1400	20.41	28.50	9.53	13.56	1.28	0.90	36.09	23.46	1.26
1500	20.24	28.77	9.75	12.59	1.31	0.91	36.10	23.56	1.27
1600	20.07	29.08	9.94	11.76	1.34	0.92	36.09	23.51	1.34
1700	19.89	29.34	10.05	11.08	1.37	0.93	35.56	23.48	1.35
1800	19.67	29.63	9.92	10.52	1.39	0.94	35.39	23.30	1.37
1900	19.40	29.96	9.50	10.06	1.42	0.96	35.40	23.27	1.49
2000	19.08	30.31	8.75	9.68	1.44	0.99	35.35	23.38	1.55
2100	18.70	30.67	7.77	9.34	1.46	1.03	35.30	23.27	1.68
2200	18.24	31.10	6.75	9.03	1.47	1.08	35.28	23.39	1.85
2300	17.69	31.52	5.76	8.81	1.49	1.13	34.72	22.85	2.00
2400	17.10	32.04	4.89	8.55	1.50	1.18	34.15	22.55	2.17
2500	16.42	32.53	4.14	8.32	1.51	1.23	34.53	22.80	2.45

Typical Performance Data

Definitions:

Input Return Loss = -S11 (dB)

Gain(Power Gain) = S21 (dB)

Reverse Isolation = -S12 (dB)

Output Return Loss = -S22 (dB)

TEST CONDITIONS: Vd = 3.00V, Id = 69.49mA @ Temperature = -45°C

FREQ	Gain	Isolation	Input Return Loss	Output Return Loss	Stability		IP-3 Output	1dB Comp. Output	Noise Figure
					K	Measure			
(MHz)	(dB)	(dB)	(dB)	(dB)	K	Measure	(dBm)	(dBm)	(dB)
20	22.79	26.01	10.58	15.60	1.03	0.52	32.48	15.41	0.82
30	22.49	25.47	12.11	16.33	1.03	0.50	33.91	16.91	0.80
40	22.28	25.21	13.02	15.85	1.03	0.48	34.84	18.09	0.78
50	22.14	25.12	13.65	15.55	1.03	0.48	34.72	18.58	0.74
60	22.07	25.00	14.07	15.43	1.03	0.47	34.74	18.73	0.78
70	22.01	24.95	14.34	15.36	1.04	0.46	34.73	18.79	0.74
80	21.97	24.92	14.54	15.33	1.04	0.46	34.46	18.89	0.73
90	21.94	24.90	14.68	15.36	1.04	0.46	34.45	18.97	0.74
100	21.92	24.88	14.81	15.38	1.04	0.46	34.47	18.88	0.70
150	21.84	24.86	14.81	15.68	1.04	0.47	34.37	19.04	0.82
200	21.77	24.90	14.38	15.83	1.05	0.49	34.15	19.12	0.71
250	21.69	24.96	13.61	15.89	1.05	0.51	34.08	19.19	0.72
300	21.61	25.04	12.85	16.03	1.05	0.53	34.20	19.14	0.74
350	21.52	25.13	12.21	16.41	1.05	0.56	33.92	19.16	0.73
400	21.43	25.23	11.68	17.02	1.06	0.59	33.46	19.07	0.79
450	21.33	25.33	11.20	17.92	1.06	0.63	33.11	19.06	0.78
500	21.23	25.44	10.74	18.98	1.07	0.66	32.80	18.94	0.80
550	21.13	25.55	10.32	20.36	1.07	0.69	32.51	18.86	0.81
600	21.02	25.68	9.93	21.91	1.08	0.73	32.13	18.98	0.96
650	20.90	25.81	9.59	23.62	1.08	0.76	31.85	18.75	0.92
700	20.78	25.95	9.28	24.79	1.09	0.79	31.63	18.89	0.81
750	20.66	26.10	8.98	24.96	1.10	0.82	31.44	18.88	0.83
800	20.52	26.26	8.69	23.90	1.11	0.84	31.29	18.84	0.83
850	20.39	26.42	8.44	22.60	1.12	0.87	30.86	18.53	0.89
900	20.27	26.56	8.22	21.29	1.13	0.89	30.77	18.56	0.88
950	20.17	26.68	8.09	20.13	1.13	0.91	30.72	18.88	0.85
1000	20.06	26.81	7.99	19.01	1.14	0.93	30.53	18.81	0.91
1100	19.84	27.07	7.81	16.87	1.16	0.95	30.30	18.47	0.85
1200	19.60	27.32	7.68	15.12	1.17	0.97	30.00	18.61	0.95
1300	19.38	27.54	7.70	13.72	1.19	0.99	29.98	18.57	0.98
1400	19.17	27.74	7.77	12.58	1.20	0.99	29.67	18.29	1.00
1500	18.95	27.90	7.87	11.64	1.22	0.99	29.42	18.36	1.00
1600	18.74	28.08	7.98	10.85	1.23	0.99	29.35	18.24	1.09
1700	18.51	28.21	8.02	10.18	1.24	1.00	28.91	18.14	1.07
1800	18.25	28.37	7.93	9.68	1.25	1.01	28.94	17.90	1.10
1900	17.93	28.58	7.58	9.29	1.26	1.03	28.83	17.82	1.18
2000	17.54	28.83	6.97	8.98	1.26	1.06	28.53	17.79	1.21
2100	17.09	29.11	6.21	8.75	1.26	1.10	28.41	17.68	1.34
2200	16.57	29.46	5.44	8.56	1.27	1.15	28.02	17.62	1.50
2300	15.95	29.85	4.69	8.39	1.28	1.19	27.90	17.31	1.61
2400	15.29	30.32	4.03	8.21	1.29	1.24	27.54	17.11	1.75
2500	14.57	30.82	3.43	8.08	1.31	1.29	27.77	17.06	1.99

Typical Performance Data

Definitions:

Input Return Loss = -S11 (dB)

Gain(Power Gain) = S21 (dB)

Reverse Isolation = -S12 (dB)

Output Return Loss = -S22 (dB)

TEST CONDITIONS: Vd = 5.00V, Id = 141.13mA @ Temperature = -45°C

FREQ	Gain	Isolation	Input Return Loss	Output Return Loss	Stability		IP-3 Output	1dB Comp. Output	Noise Figure
					K	Measure			
(MHz)	(dB)	(dB)	(dB)	(dB)	K	Measure	(dBm)	(dBm)	(dB)
20	23.51	26.41	10.53	14.96	1.02	0.48	41.63	21.53	0.86
30	23.17	25.92	11.71	14.96	1.02	0.45	42.96	22.79	0.81
40	22.93	25.69	12.34	14.36	1.02	0.44	42.54	23.55	0.80
50	22.78	25.58	12.69	14.02	1.02	0.44	44.04	23.95	0.76
60	22.70	25.50	13.06	13.90	1.03	0.43	45.27	23.90	0.79
70	22.64	25.45	13.25	13.81	1.03	0.43	44.93	23.86	0.73
80	22.60	25.43	13.41	13.77	1.03	0.43	44.25	23.96	0.75
90	22.57	25.40	13.52	13.78	1.03	0.42	43.25	24.07	0.74
100	22.55	25.39	13.63	13.78	1.03	0.42	43.08	23.89	0.73
150	22.48	25.37	13.85	13.95	1.04	0.43	41.99	24.05	0.82
200	22.43	25.39	13.70	13.95	1.04	0.44	42.33	24.19	0.70
250	22.37	25.45	13.27	13.83	1.04	0.45	42.67	24.30	0.71
300	22.31	25.51	12.84	13.75	1.05	0.47	41.08	24.21	0.71
350	22.25	25.59	12.55	13.85	1.05	0.49	41.78	24.25	0.70
400	22.20	25.66	12.31	14.08	1.06	0.51	40.67	24.15	0.75
450	22.14	25.73	12.11	14.45	1.06	0.53	40.11	24.18	0.80
500	22.09	25.83	11.89	14.84	1.07	0.55	39.48	24.04	0.79
550	22.03	25.92	11.67	15.29	1.07	0.57	38.66	23.94	0.80
600	21.97	26.02	11.48	15.69	1.08	0.60	38.72	24.15	1.01
650	21.90	26.13	11.29	16.09	1.08	0.62	38.22	23.82	0.92
700	21.83	26.26	11.11	16.35	1.09	0.64	38.44	24.08	0.79
750	21.75	26.40	10.91	16.48	1.10	0.66	38.00	24.09	0.86
800	21.67	26.55	10.70	16.40	1.11	0.69	38.00	24.01	0.81
850	21.58	26.70	10.50	16.31	1.12	0.71	36.92	23.60	0.87
900	21.51	26.84	10.34	16.20	1.13	0.72	36.78	23.64	0.85
950	21.45	26.99	10.24	16.08	1.14	0.74	37.70	24.20	0.83
1000	21.39	27.13	10.17	15.90	1.15	0.76	37.86	24.17	0.94
1100	21.25	27.46	10.05	15.25	1.18	0.79	36.51	23.51	0.85
1200	21.09	27.81	9.94	14.37	1.21	0.81	36.75	23.81	0.90
1300	20.95	28.17	10.01	13.52	1.24	0.83	36.39	23.85	0.94
1400	20.80	28.53	10.15	12.69	1.27	0.85	35.53	23.26	0.98
1500	20.65	28.89	10.35	11.89	1.31	0.86	35.72	23.44	1.00
1600	20.50	29.29	10.56	11.20	1.35	0.87	35.60	23.38	1.04
1700	20.36	29.65	10.74	10.60	1.38	0.88	35.28	23.37	1.04
1800	20.18	30.04	10.74	10.08	1.42	0.89	34.74	23.17	1.06
1900	19.95	30.49	10.35	9.62	1.46	0.91	34.66	23.16	1.13
2000	19.68	30.96	9.51	9.21	1.49	0.95	34.95	23.32	1.20
2100	19.35	31.44	8.44	8.84	1.52	0.98	34.86	23.28	1.31
2200	18.95	31.97	7.33	8.51	1.54	1.03	35.29	23.49	1.44
2300	18.47	32.48	6.27	8.19	1.55	1.08	34.01	22.82	1.57
2400	17.93	33.06	5.34	7.81	1.57	1.12	33.47	22.51	1.69
2500	17.32	33.62	4.51	7.47	1.57	1.16	33.98	22.81	1.87

Typical Performance Data

Definitions:

Input Return Loss = -S11 (dB)

Gain(Power Gain) = S21 (dB)

Reverse Isolation = -S12 (dB)

Output Return Loss = -S22 (dB)

TEST CONDITIONS: Vd = 2.70V, Id = 58.08mA @ Temperature = -45°C

FREQ	Gain	Isolation	Input Return Loss	Output Return Loss	Stability		IP-3 Output	1dB Comp. Output	Noise Figure
					K	Measure			
(MHz)	(dB)	(dB)	(dB)	(dB)	K	Measure	(dBm)	(dBm)	(dB)
20	22.45	25.82	10.50	15.82	1.03	0.54	30.43	14.43	0.85
30	22.19	25.26	12.27	17.18	1.03	0.51	32.25	15.91	0.83
40	22.00	25.00	13.39	16.93	1.03	0.50	32.96	17.05	0.81
50	21.87	24.88	14.00	16.73	1.04	0.49	32.98	17.53	0.75
60	21.81	24.79	14.68	16.65	1.04	0.48	32.98	17.67	0.78
70	21.76	24.74	15.04	16.62	1.04	0.48	32.99	17.74	0.76
80	21.72	24.71	15.27	16.62	1.04	0.48	32.90	17.86	0.75
90	21.69	24.69	15.43	16.67	1.04	0.48	32.70	17.93	0.73
100	21.67	24.68	15.53	16.72	1.04	0.48	32.73	17.85	0.75
150	21.60	24.66	15.48	17.15	1.05	0.49	32.71	18.00	0.72
200	21.53	24.70	14.86	17.36	1.05	0.51	32.60	18.07	0.72
250	21.45	24.77	13.95	17.48	1.05	0.53	32.39	18.14	0.70
300	21.36	24.85	13.08	17.75	1.05	0.56	32.59	18.07	0.72
350	21.27	24.94	12.39	18.38	1.06	0.59	32.12	18.10	0.76
400	21.17	25.03	11.77	19.30	1.06	0.62	31.94	18.01	0.77
450	21.06	25.14	11.19	20.55	1.06	0.65	31.53	17.99	0.79
500	20.95	25.26	10.63	21.99	1.07	0.69	31.07	17.88	0.79
550	20.83	25.39	10.11	23.68	1.07	0.72	30.95	17.79	0.82
600	20.71	25.53	9.66	25.29	1.08	0.76	30.60	17.90	0.93
650	20.58	25.67	9.23	26.12	1.08	0.79	30.33	17.69	0.89
700	20.45	25.82	8.87	25.47	1.09	0.82	30.06	17.82	0.84
750	20.31	25.98	8.54	23.98	1.10	0.85	29.92	17.79	0.92
800	20.15	26.15	8.24	22.20	1.11	0.88	29.82	17.74	0.84
850	20.01	26.31	7.97	20.59	1.12	0.90	29.42	17.44	0.92
900	19.89	26.44	7.75	19.23	1.12	0.92	29.36	17.48	0.88
950	19.77	26.57	7.60	18.05	1.13	0.94	29.31	17.75	0.88
1000	19.65	26.69	7.48	17.02	1.13	0.95	29.05	17.72	0.96
1100	19.41	26.94	7.30	15.21	1.14	0.98	28.90	17.36	0.87
1200	19.16	27.16	7.23	13.67	1.16	0.99	28.61	17.49	0.94
1300	18.93	27.34	7.30	12.35	1.17	1.00	28.63	17.43	0.99
1400	18.70	27.50	7.41	11.34	1.18	1.00	28.35	17.19	1.02
1500	18.48	27.61	7.58	10.57	1.19	0.99	28.05	17.21	1.00
1600	18.27	27.75	7.76	9.90	1.20	0.99	28.05	17.07	1.08
1700	18.04	27.84	7.86	9.32	1.20	0.99	27.57	16.96	1.07
1800	17.76	27.94	7.79	8.91	1.21	0.99	27.67	16.72	1.09
1900	17.42	28.14	7.46	8.55	1.22	1.01	27.52	16.61	1.17
2000	17.01	28.39	6.89	8.33	1.23	1.04	27.19	16.55	1.21
2100	16.54	28.63	6.12	8.18	1.22	1.09	27.07	16.43	1.34
2200	15.98	28.99	5.32	8.06	1.23	1.14	26.69	16.32	1.46
2300	15.31	29.39	4.54	7.97	1.24	1.19	26.60	16.05	1.61
2400	14.59	29.89	3.83	7.91	1.26	1.24	26.22	15.86	1.79
2500	13.82	30.43	3.22	7.87	1.28	1.30	26.49	15.79	2.05

Typical Performance Data

Definitions:

Input Return Loss = -S11 (dB)

Gain(Power Gain) = S21 (dB)

Reverse Isolation = -S12 (dB)

Output Return Loss = -S22 (dB)

TEST CONDITIONS: Vd = 5.25V, Id = 149.96mA @ Temperature = -45°C

FREQ	Gain	Isolation	Input Return Loss	Output Return Loss	Stability		IP-3 Output	1dB Comp. Output	Noise Figure
					K	Measure			
(MHz)	(dB)	(dB)	(dB)	(dB)	K	Measure	(dBm)	(dBm)	(dB)
20	23.56	26.43	10.50	14.93	1.02	0.47	42.56	22.09	0.90
30	23.21	25.95	11.69	14.88	1.02	0.45	45.29	23.23	0.83
40	22.97	25.73	12.29	14.27	1.02	0.44	49.74	23.98	0.80
50	22.82	25.60	12.59	13.93	1.02	0.43	43.58	24.38	0.77
60	22.74	25.54	12.99	13.81	1.03	0.43	44.36	24.33	0.80
70	22.68	25.49	13.17	13.73	1.03	0.42	44.54	24.28	0.76
80	22.64	25.46	13.31	13.68	1.03	0.42	43.20	24.39	0.74
90	22.61	25.44	13.43	13.69	1.03	0.42	44.73	24.50	0.76
100	22.59	25.43	13.54	13.69	1.03	0.42	43.55	24.32	0.74
150	22.52	25.40	13.75	13.84	1.04	0.43	44.13	24.48	0.78
200	22.47	25.43	13.61	13.83	1.04	0.44	43.20	24.63	0.71
250	22.41	25.49	13.19	13.72	1.04	0.45	43.50	24.74	0.73
300	22.35	25.55	12.78	13.63	1.05	0.47	42.87	24.65	0.76
350	22.29	25.62	12.50	13.71	1.05	0.48	42.07	24.71	0.74
400	22.24	25.70	12.28	13.92	1.05	0.50	41.92	24.60	0.82
450	22.18	25.77	12.09	14.27	1.06	0.52	42.16	24.64	0.79
500	22.13	25.86	11.89	14.63	1.06	0.54	41.41	24.50	0.79
550	22.07	25.95	11.69	15.05	1.07	0.57	40.19	24.40	0.81
600	22.01	26.06	11.50	15.42	1.08	0.59	40.27	24.62	1.05
650	21.95	26.17	11.32	15.79	1.08	0.61	39.65	24.30	0.92
700	21.88	26.29	11.15	16.02	1.09	0.64	39.89	24.57	0.83
750	21.80	26.43	10.96	16.13	1.10	0.66	39.67	24.56	0.90
800	21.71	26.58	10.76	16.04	1.11	0.68	39.50	24.51	0.83
850	21.63	26.74	10.56	15.95	1.12	0.70	38.57	24.10	0.91
900	21.57	26.88	10.41	15.84	1.13	0.72	38.48	24.13	0.88
950	21.51	27.02	10.32	15.73	1.14	0.73	39.30	24.69	0.88
1000	21.44	27.17	10.26	15.56	1.15	0.75	39.28	24.69	0.93
1100	21.30	27.50	10.15	14.95	1.18	0.78	38.12	24.03	0.85
1200	21.15	27.86	10.04	14.12	1.21	0.80	38.36	24.34	0.94
1300	21.01	28.22	10.12	13.32	1.24	0.82	38.11	24.37	0.97
1400	20.86	28.60	10.27	12.52	1.28	0.84	36.94	23.79	0.98
1500	20.71	28.97	10.46	11.75	1.32	0.85	37.44	23.94	1.01
1600	20.57	29.38	10.69	11.07	1.36	0.86	37.18	23.89	1.07
1700	20.42	29.77	10.87	10.49	1.39	0.87	36.85	23.89	1.05
1800	20.24	30.18	10.86	9.97	1.43	0.89	36.36	23.68	1.08
1900	20.02	30.64	10.48	9.52	1.47	0.91	36.15	23.66	1.13
2000	19.74	31.13	9.62	9.10	1.51	0.94	36.51	23.85	1.19
2100	19.42	31.64	8.52	8.73	1.54	0.98	36.66	23.80	1.31
2200	19.02	32.19	7.41	8.38	1.57	1.02	37.06	23.99	1.44
2300	18.55	32.70	6.33	8.06	1.58	1.07	35.61	23.31	1.61
2400	18.01	33.31	5.39	7.68	1.60	1.11	34.90	23.00	1.70
2500	17.40	33.88	4.56	7.32	1.60	1.15	35.51	23.31	1.92

Typical Performance Data

Definitions:

Input Return Loss = -S11 (dB)

Gain(Power Gain) = S21 (dB)

Reverse Isolation = -S12 (dB)

Output Return Loss = -S22 (dB)

TEST CONDITIONS: Vd = 3.00V, Id = 72.10mA @ Temperature = +105°C

FREQ	Gain	Isolation	Input Return Loss	Output Return Loss	Stability		IP-3 Output	1dB Comp. Output	Noise Figure
					K	Measure			
(MHz)	(dB)	(dB)	(dB)	(dB)	K	Measure	(dBm)	(dBm)	(dB)
20	22.24	26.09	10.68	15.06	1.05	0.59	31.62	14.90	1.31
30	21.96	25.53	12.41	15.73	1.05	0.56	33.01	16.35	1.28
40	21.75	25.26	13.47	15.25	1.05	0.54	34.01	17.39	1.26
50	21.61	25.11	13.97	14.89	1.05	0.53	33.68	17.83	1.22
60	21.54	25.04	14.57	14.68	1.05	0.52	33.93	18.01	1.30
70	21.48	24.99	14.80	14.50	1.05	0.52	34.04	18.08	1.22
80	21.43	24.96	14.87	14.36	1.06	0.52	33.56	18.21	1.25
90	21.40	24.95	14.89	14.26	1.06	0.52	33.71	18.29	1.35
100	21.37	24.94	14.85	14.17	1.06	0.52	33.71	18.23	1.27
150	21.26	24.95	14.19	14.02	1.06	0.53	33.71	18.38	1.25
200	21.16	25.00	13.40	14.22	1.06	0.56	33.93	18.46	1.22
250	21.08	25.08	12.63	14.74	1.07	0.59	33.95	18.52	1.24
300	20.98	25.16	11.96	15.52	1.07	0.62	34.11	18.49	1.25
350	20.89	25.25	11.35	16.51	1.07	0.65	33.90	18.53	1.26
400	20.78	25.35	10.77	17.61	1.08	0.69	33.59	18.45	1.31
450	20.67	25.47	10.21	18.92	1.09	0.73	33.33	18.46	1.29
500	20.55	25.60	9.69	20.34	1.09	0.76	32.98	18.34	1.35
550	20.42	25.74	9.21	22.08	1.10	0.80	32.88	18.27	1.36
600	20.28	25.88	8.79	24.06	1.10	0.83	32.35	18.40	1.54
650	20.14	26.04	8.41	26.43	1.11	0.87	32.07	18.15	1.51
700	19.99	26.20	8.09	28.33	1.12	0.90	31.82	18.30	1.37
750	19.85	26.36	7.82	28.27	1.13	0.93	31.60	18.26	1.41
800	19.70	26.52	7.58	25.93	1.14	0.95	31.49	18.23	1.43
850	19.57	26.66	7.37	23.52	1.15	0.98	31.10	17.95	1.51
900	19.43	26.81	7.19	21.38	1.15	1.00	30.98	17.97	1.49
950	19.31	26.94	7.06	19.65	1.16	1.01	30.92	18.27	1.51
1000	19.17	27.06	6.94	18.21	1.17	1.03	30.68	18.23	1.58
1100	18.92	27.29	6.81	15.91	1.18	1.05	30.56	17.87	1.51
1200	18.68	27.48	6.79	14.20	1.20	1.05	30.27	18.01	1.60
1300	18.44	27.64	6.85	12.88	1.21	1.06	30.27	18.03	1.62
1400	18.21	27.76	6.96	11.79	1.22	1.05	30.02	17.74	1.69
1500	17.98	27.87	7.11	10.91	1.24	1.05	29.77	17.76	1.72
1600	17.73	28.01	7.21	10.19	1.25	1.04	29.71	17.67	1.79
1700	17.46	28.12	7.22	9.59	1.26	1.04	29.31	17.59	1.80
1800	17.13	28.27	7.07	9.12	1.27	1.05	29.42	17.41	1.84
1900	16.74	28.49	6.74	8.74	1.29	1.07	29.37	17.36	1.98
2000	16.29	28.75	6.22	8.44	1.31	1.09	28.96	17.29	2.06
2100	15.76	29.05	5.58	8.21	1.32	1.13	28.89	17.22	2.24
2200	15.15	29.44	4.90	8.03	1.35	1.16	28.45	17.16	2.47
2300	14.46	29.86	4.25	7.92	1.38	1.21	28.44	16.88	2.67
2400	13.71	30.37	3.67	7.83	1.43	1.25	28.07	16.64	2.95
2500	12.90	30.93	3.16	7.76	1.49	1.29	28.25	16.65	3.26

Typical Performance Data

Definitions:

Input Return Loss = -S11 (dB)

Gain(Power Gain) = S21 (dB)

Reverse Isolation = -S12 (dB)

Output Return Loss = -S22 (dB)

TEST CONDITIONS: Vd = 5.00V, Id = 135.50mA @ Temperature = +105°C

FREQ	Gain	Isolation	Input Return Loss	Output Return Loss	Stability		IP-3 Output	1dB Comp. Output	Noise Figure
					K	Measure			
(MHz)	(dB)	(dB)	(dB)	(dB)	K	Measure	(dBm)	(dBm)	(dB)
20	22.92	26.68	10.84	13.92	1.05	0.56	37.12	20.33	1.36
30	22.61	26.14	12.13	13.97	1.04	0.53	37.74	21.50	1.32
40	22.40	25.89	12.84	13.45	1.04	0.51	38.23	22.23	1.27
50	22.24	25.80	13.25	13.11	1.05	0.51	38.67	22.55	1.22
60	22.17	25.68	13.49	12.92	1.05	0.50	39.41	22.69	1.33
70	22.11	25.64	13.60	12.76	1.05	0.49	39.45	22.71	1.28
80	22.06	25.61	13.61	12.64	1.05	0.49	38.93	22.84	1.28
90	22.03	25.60	13.61	12.55	1.05	0.49	39.08	22.90	1.38
100	22.00	25.59	13.58	12.47	1.05	0.49	39.18	22.84	1.30
150	21.90	25.59	13.16	12.30	1.06	0.50	39.47	22.96	1.23
200	21.82	25.63	12.75	12.40	1.06	0.51	39.29	23.07	1.27
250	21.76	25.68	12.38	12.74	1.07	0.54	39.68	23.16	1.29
300	21.71	25.73	12.06	13.24	1.07	0.56	39.18	23.18	1.27
350	21.65	25.80	11.79	13.86	1.07	0.59	39.54	23.24	1.34
400	21.58	25.88	11.46	14.51	1.08	0.61	39.37	23.19	1.32
450	21.51	25.97	11.11	15.23	1.09	0.64	39.33	23.23	1.32
500	21.43	26.07	10.75	15.92	1.09	0.67	39.01	23.15	1.39
550	21.34	26.17	10.41	16.70	1.10	0.70	38.77	23.14	1.41
600	21.25	26.30	10.09	17.49	1.11	0.72	38.63	23.27	1.64
650	21.16	26.42	9.79	18.38	1.12	0.75	38.37	23.04	1.52
700	21.06	26.56	9.54	19.26	1.13	0.78	38.47	23.20	1.38
750	20.96	26.71	9.33	20.13	1.14	0.80	38.16	23.21	1.45
800	20.87	26.85	9.14	20.77	1.15	0.83	37.98	23.17	1.47
850	20.78	26.99	8.96	21.15	1.16	0.85	37.53	22.87	1.55
900	20.69	27.13	8.81	21.01	1.17	0.87	37.45	22.91	1.50
950	20.61	27.27	8.69	20.50	1.18	0.89	37.52	23.24	1.53
1000	20.52	27.41	8.59	19.73	1.19	0.90	37.37	23.10	1.57
1100	20.34	27.70	8.48	17.86	1.22	0.92	36.78	22.73	1.52
1200	20.17	27.98	8.47	16.13	1.24	0.94	36.55	22.85	1.58
1300	20.00	28.25	8.55	14.69	1.27	0.95	36.43	22.88	1.63
1400	19.84	28.51	8.70	13.45	1.30	0.95	36.12	22.47	1.67
1500	19.67	28.74	8.89	12.44	1.32	0.96	35.86	22.46	1.70
1600	19.49	29.00	9.05	11.58	1.35	0.96	35.71	22.41	1.79
1700	19.28	29.24	9.09	10.87	1.37	0.97	35.25	22.33	1.77
1800	19.03	29.50	8.92	10.27	1.39	0.98	35.45	22.24	1.83
1900	18.73	29.81	8.52	9.78	1.42	1.00	35.29	22.23	1.95
2000	18.37	30.14	7.84	9.36	1.44	1.03	35.09	22.19	2.04
2100	17.94	30.49	6.99	9.00	1.45	1.06	35.05	22.10	2.20
2200	17.43	30.91	6.10	8.70	1.47	1.11	34.76	22.07	2.38
2300	16.83	31.33	5.24	8.48	1.49	1.16	34.51	21.70	2.60
2400	16.18	31.85	4.47	8.26	1.51	1.20	34.04	21.40	2.84
2500	15.44	32.33	3.81	8.08	1.54	1.25	34.35	21.57	3.12

Typical Performance Data

Definitions:

Input Return Loss = -S11 (dB)

Gain(Power Gain) = S21 (dB)

Reverse Isolation = -S12 (dB)

Output Return Loss = -S22 (dB)

TEST CONDITIONS: Vd = 2.70V, Id = 64.27mA @ Temperature = +105°C

FREQ	Gain	Isolation	Input Return Loss	Output Return Loss	Stability		IP-3 Output	1dB Comp. Output	Noise Figure
					K	Measure			
(MHz)	(dB)	(dB)	(dB)	(dB)	K	Measure	(dBm)	(dBm)	(dB)
20	21.94	25.86	10.58	15.46	1.05	0.60	29.54	13.97	1.33
30	21.69	25.28	12.49	16.65	1.05	0.57	31.79	15.43	1.29
40	21.51	25.01	13.71	16.32	1.05	0.55	32.84	16.53	1.26
50	21.38	24.86	14.41	16.02	1.05	0.54	32.79	17.00	1.22
60	21.32	24.79	15.08	15.82	1.05	0.53	32.66	17.15	1.27
70	21.26	24.75	15.38	15.64	1.06	0.53	32.74	17.24	1.27
80	21.22	24.72	15.53	15.50	1.06	0.53	32.57	17.36	1.23
90	21.19	24.70	15.54	15.41	1.06	0.53	32.43	17.46	1.23
100	21.16	24.69	15.50	15.31	1.06	0.53	32.61	17.36	1.25
150	21.06	24.70	14.76	15.16	1.06	0.54	32.64	17.51	1.28
200	20.96	24.76	13.82	15.41	1.06	0.57	32.67	17.59	1.23
250	20.87	24.84	12.88	16.06	1.07	0.60	32.83	17.65	1.23
300	20.77	24.93	12.09	17.01	1.07	0.63	32.85	17.59	1.29
350	20.67	25.03	11.39	18.28	1.07	0.67	32.28	17.62	1.26
400	20.56	25.15	10.73	19.75	1.08	0.71	32.25	17.53	1.30
450	20.44	25.27	10.10	21.50	1.08	0.74	31.83	17.53	1.31
500	20.31	25.41	9.53	23.43	1.09	0.78	31.35	17.40	1.33
550	20.17	25.56	9.03	25.74	1.10	0.82	31.12	17.30	1.35
600	20.03	25.72	8.58	27.90	1.10	0.85	30.73	17.43	1.60
650	19.87	25.88	8.17	28.73	1.11	0.89	30.38	17.17	1.46
700	19.72	26.05	7.83	26.99	1.12	0.92	30.11	17.33	1.42
750	19.56	26.22	7.55	24.45	1.13	0.95	30.01	17.29	1.48
800	19.41	26.38	7.30	22.04	1.13	0.97	29.88	17.26	1.41
850	19.27	26.53	7.08	20.11	1.14	0.99	29.47	16.95	1.51
900	19.13	26.66	6.91	18.50	1.15	1.01	29.45	16.97	1.47
950	18.99	26.78	6.78	17.16	1.15	1.02	29.42	17.31	1.49
1000	18.85	26.90	6.67	16.05	1.16	1.04	29.29	17.29	1.55
1100	18.59	27.10	6.58	14.21	1.17	1.05	29.08	16.91	1.49
1200	18.35	27.26	6.60	12.81	1.18	1.05	28.81	17.09	1.56
1300	18.11	27.37	6.70	11.70	1.19	1.05	28.93	17.08	1.64
1400	17.89	27.46	6.87	10.79	1.20	1.04	28.64	16.79	1.67
1500	17.66	27.53	7.09	10.05	1.21	1.03	28.38	16.84	1.69
1600	17.41	27.64	7.26	9.44	1.22	1.02	28.37	16.73	1.78
1700	17.14	27.73	7.30	8.93	1.23	1.02	28.01	16.66	1.77
1800	16.80	27.83	7.15	8.58	1.24	1.03	28.10	16.45	1.83
1900	16.40	28.05	6.79	8.26	1.25	1.05	28.04	16.39	1.94
2000	15.92	28.33	6.24	8.06	1.28	1.08	27.70	16.37	2.07
2100	15.36	28.63	5.54	7.90	1.29	1.12	27.59	16.28	2.22
2200	14.71	29.04	4.82	7.79	1.32	1.16	27.20	16.23	2.47
2300	13.97	29.49	4.15	7.74	1.36	1.21	27.15	15.92	2.69
2400	13.19	30.03	3.54	7.70	1.41	1.26	26.77	15.71	2.96
2500	12.33	30.62	3.05	7.65	1.48	1.30	26.97	15.69	3.30

Typical Performance Data

Definitions:

Input Return Loss = -S11 (dB)

Gain(Power Gain) = S21 (dB)

Reverse Isolation = -S12 (dB)

Output Return Loss = -S22 (dB)

TEST CONDITIONS: Vd = 5.25V, Id = 142.71mA @ Temperature = +105°C

FREQ	Gain	Isolation	Input Return Loss	Output Return Loss	Stability		IP-3 Output	1dB Comp. Output	Noise Figure
					K	Measure			
(MHz)	(dB)	(dB)	(dB)	(dB)	K	Measure	(dBm)	(dBm)	(dB)
20	22.78	26.89	10.63	12.99	1.06	0.58	36.35	20.37	1.37
30	22.50	26.32	12.00	13.26	1.05	0.55	37.94	21.64	1.32
40	22.30	26.05	12.74	12.88	1.05	0.53	39.39	22.41	1.30
50	22.16	25.92	13.19	12.62	1.05	0.52	38.87	22.73	1.25
60	22.09	25.83	13.44	12.47	1.06	0.51	38.63	22.90	1.34
70	22.03	25.78	13.55	12.33	1.06	0.51	39.39	22.95	1.28
80	21.99	25.75	13.59	12.23	1.06	0.51	39.07	23.09	1.29
90	21.96	25.73	13.56	12.16	1.06	0.50	39.07	23.16	1.36
100	21.93	25.71	13.53	12.08	1.06	0.50	39.26	23.12	1.33
150	21.84	25.71	13.06	11.94	1.06	0.51	39.20	23.27	1.33
200	21.78	25.74	12.60	12.03	1.07	0.52	39.71	23.39	1.29
250	21.73	25.78	12.21	12.35	1.07	0.54	39.72	23.51	1.32
300	21.68	25.82	11.88	12.81	1.07	0.56	40.03	23.54	1.29
350	21.64	25.88	11.61	13.38	1.08	0.59	39.49	23.63	1.32
400	21.58	25.95	11.31	13.96	1.08	0.61	39.83	23.60	1.35
450	21.52	26.02	10.98	14.60	1.09	0.64	39.81	23.65	1.40
500	21.45	26.12	10.65	15.20	1.09	0.66	39.04	23.59	1.41
550	21.38	26.22	10.34	15.86	1.10	0.69	39.34	23.59	1.44
600	21.30	26.33	10.06	16.52	1.11	0.71	39.25	23.71	1.76
650	21.22	26.45	9.80	17.24	1.12	0.74	39.12	23.49	1.52
700	21.13	26.58	9.57	17.93	1.13	0.76	38.88	23.65	1.47
750	21.05	26.71	9.38	18.62	1.14	0.79	38.79	23.67	1.49
800	20.96	26.85	9.23	19.12	1.15	0.81	38.81	23.64	1.50
850	20.88	26.99	9.06	19.47	1.16	0.83	38.19	23.34	1.58
900	20.80	27.12	8.93	19.44	1.17	0.85	37.90	23.38	1.51
950	20.73	27.27	8.83	19.15	1.18	0.86	38.11	23.70	1.51
1000	20.64	27.41	8.74	18.62	1.19	0.88	37.87	23.53	1.62
1100	20.48	27.71	8.65	17.16	1.22	0.90	37.36	23.17	1.54
1200	20.32	28.01	8.64	15.68	1.24	0.92	37.10	23.24	1.63
1300	20.15	28.30	8.73	14.39	1.27	0.93	37.01	23.30	1.64
1400	19.99	28.58	8.87	13.24	1.30	0.94	36.46	22.90	1.69
1500	19.82	28.84	9.08	12.29	1.33	0.94	36.25	22.86	1.70
1600	19.64	29.14	9.24	11.47	1.36	0.95	36.30	22.81	1.79
1700	19.44	29.41	9.28	10.78	1.39	0.95	35.83	22.69	1.80
1800	19.19	29.69	9.10	10.20	1.41	0.97	35.83	22.65	1.84
1900	18.90	30.04	8.68	9.71	1.44	0.99	35.91	22.65	1.98
2000	18.54	30.40	7.99	9.29	1.46	1.02	35.65	22.59	2.03
2100	18.12	30.77	7.12	8.92	1.48	1.05	35.52	22.48	2.22
2200	17.62	31.20	6.21	8.60	1.50	1.10	35.37	22.47	2.44
2300	17.03	31.64	5.33	8.37	1.51	1.15	35.00	22.08	2.65
2400	16.38	32.16	4.54	8.15	1.54	1.19	34.52	21.74	2.86
2500	15.64	32.65	3.87	7.94	1.57	1.24	34.89	21.92	3.17

Typical Performance Curves

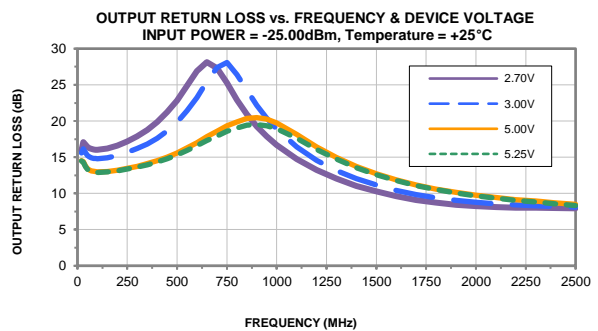
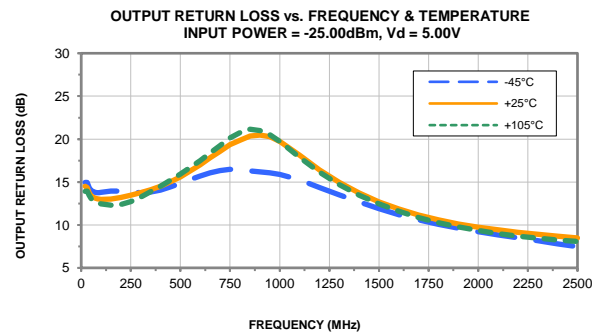
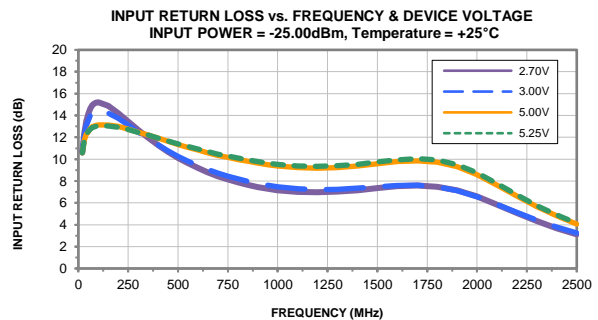
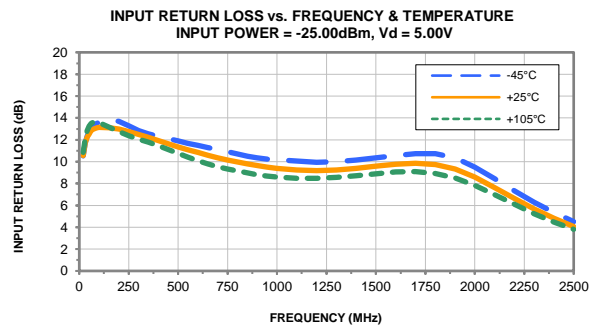
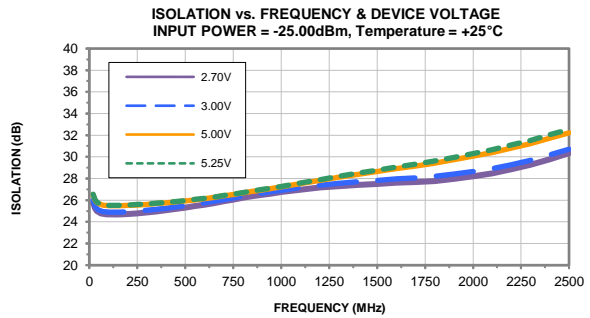
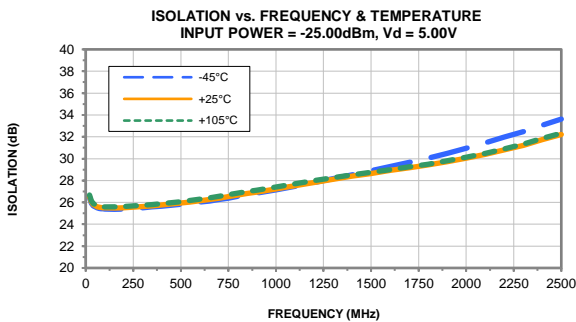
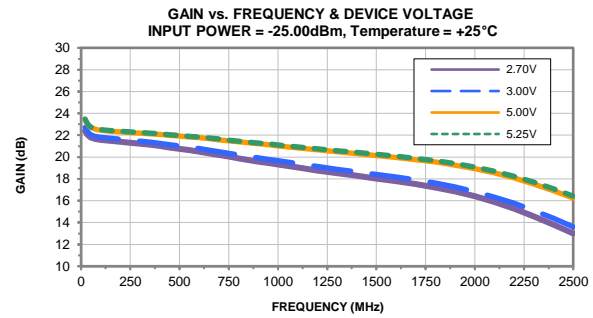
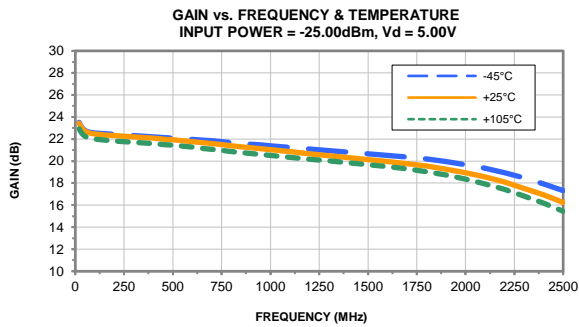

Typical Performance Curves

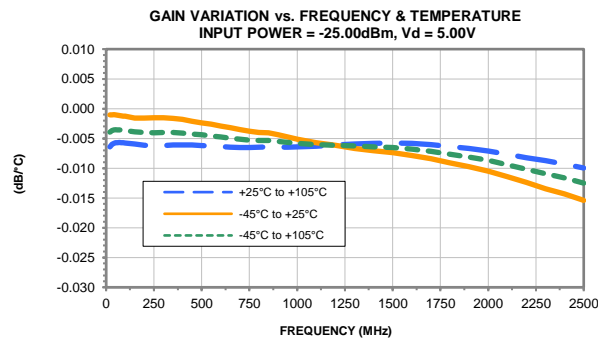
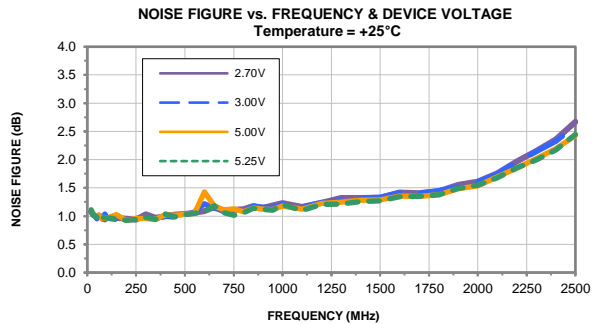
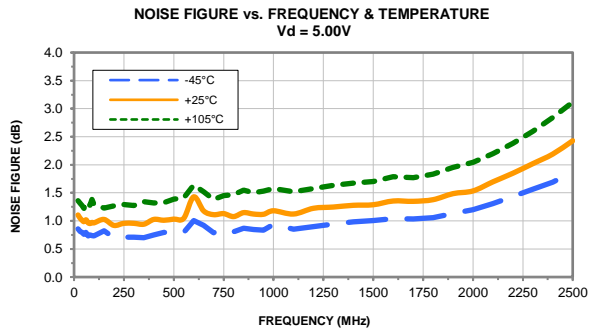
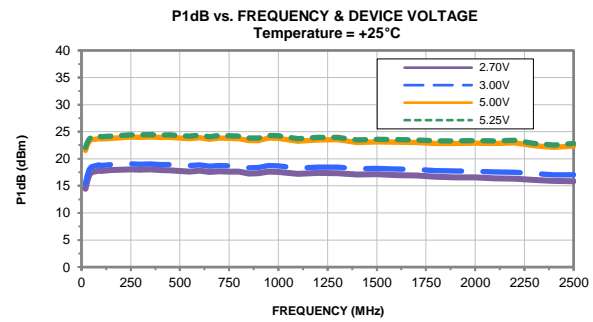
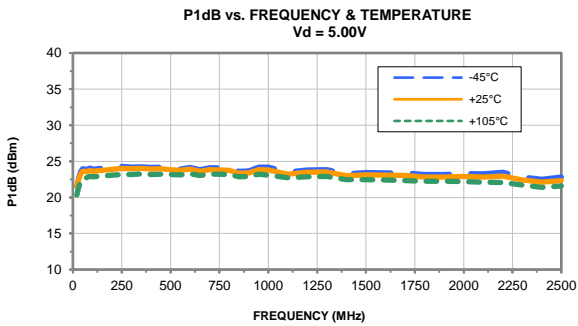
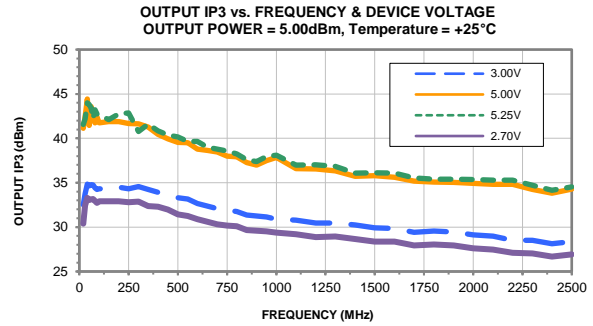
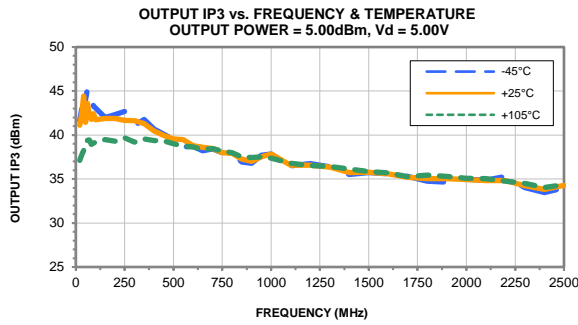

Outline Dimensions

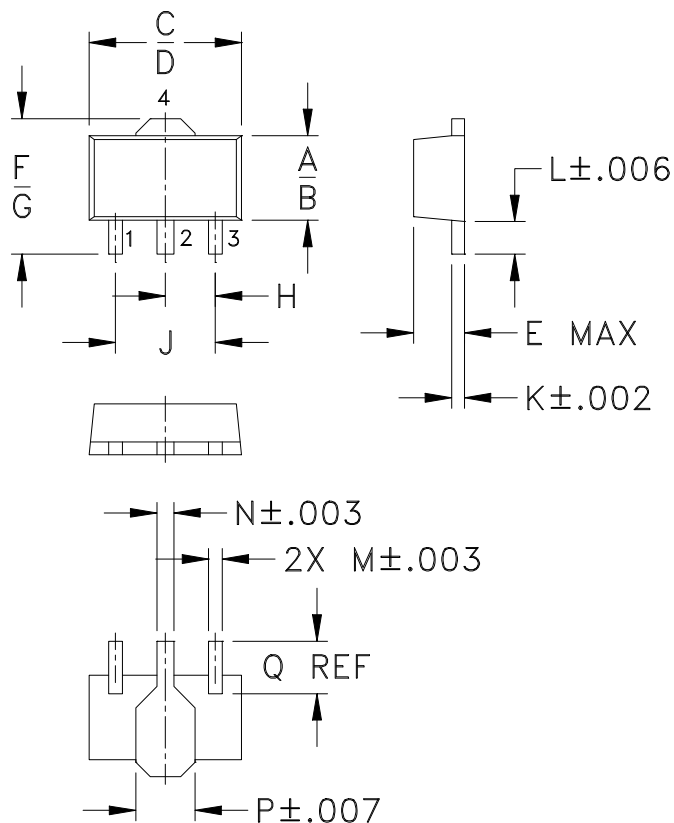

PCB Land Pattern

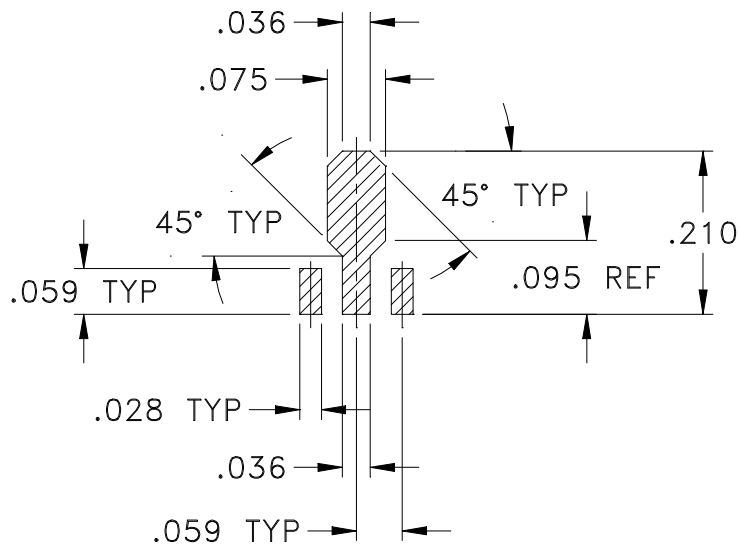

Suggested Layout,
Tolerance to be within $\pm .002$

CASE #	A	B	C	D	E	F	G	H	J	K	L	M
DF782	.102 (2.59)	.090 (2.29)	.181 (4.60)	.173 (4.39)	.063 (1.60)	.167 (4.24)	.155 (3.94)	.059 (1.50)	.118 (3.00)	.015 (0.38)	.041 (1.04)	.016 (0.41)

CASE #	N	P	Q	WT. GRAM
DF782	.019 (0.48)	.065 (1.65)	.062 (1.57)	.2

Dimensions are in inches (mm). Tolerances: 2 Pl. $\pm .01$; 3Pl. $\pm .005$

Notes:

- Case material: Plastic.
- Termination finish:
 For RoHS Case Styles: Tin-Silver alloy plate over Nickel barrier or Matte-Tin.
 All models, (+) suffix. See model Data sheet.
 For RoHS-5 Case Styles: Tin-Lead plate. All models, no (+) suffix.



INTERNET <http://www.minicircuits.com>

P.O. Box 350166, Brooklyn, New York 11235-0003 (718) 934-4500 Fax (718) 332-4661

Distribution Centers NORTH AMERICA 800-654-7949 • 417-335-5935 • Fax 417-335-5945 • EUROPE 44-1252-832600 • Fax 44-1252-837010

Mini-Circuits ISO 9001 & ISO 14001 Certified

Tape & Reel Packaging TR-F55

DEVICE ORIENTATION IN T&R

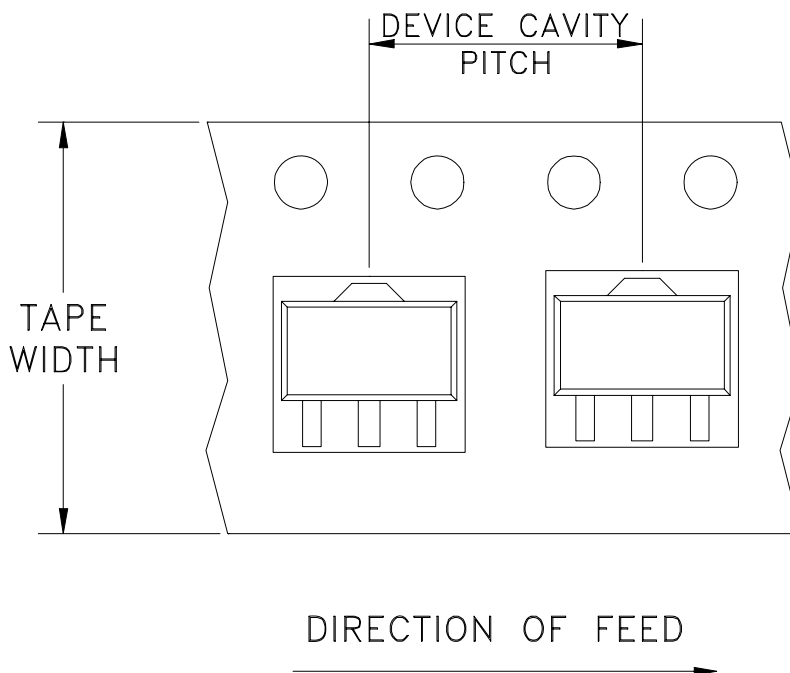

Tape Width, mm	Device Cavity Pitch, mm	Reel Size, inches	Devices per Reel	
12	8	7	Small quantity standard (see note)	20
				50
				100
				200
				500
			Standard	1000

Note: Please consult individual model data sheet to determine device per reel availability.

Mini-Circuits carrier tape materials provide protection from ESD (Electro-Static Discharge) during handling and transportation. Tapes are static dissipative and comply with industry standards EIA-481/EIA-541.

Go to: www.minicircuits.com/pages/pdfs/tape.pdf



INTERNET <http://www.minicircuits.com>

P.O. Box 350166, Brooklyn, New York 11235-0003 (718) 934-4500 Fax (718) 332-4661

Distribution Centers NORTH AMERICA 800-654-7949 • 417-335-5935 • Fax 417-335-5945 • EUROPE 44-1252-832600 • Fax 44-1252-837010

Mini-Circuits ISO 9001 & ISO 14001 Certified

THIRD ANGLE PROJECTION

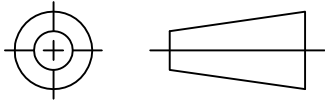

REVISIONS

REV	ECN No.	DESCRIPTION	DATE	DR	AUTH
OR	M161405	NEW RELEASE	04/19/17	GF	RS

SUGGESTED MOUNTING CONFIGURATION FOR
DF782 CASE STYLE, "04AM03" PIN CONNECTION

COMPONENT	SIZE
R1,L2,C1-C6	0402
L1	0805

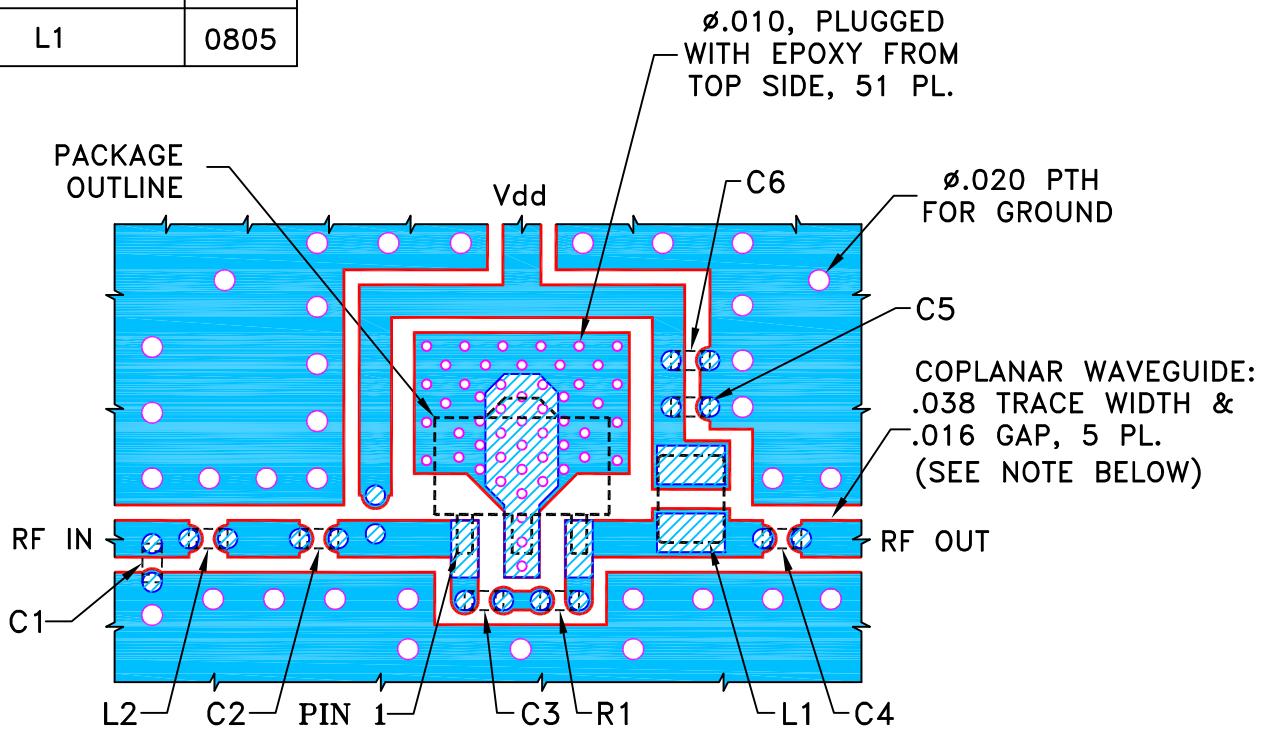

NOTES:

1. TRACE WIDTH & GAP PARAMETERS ARE SHOWN FOR ROGERS RO4350B WITH DIELECTRIC THICKNESS $.020 \pm .0015$ ". COPPER: 1/2 OZ. EACH SIDE. FOR OTHER MATERIALS TRACE WIDTH & GAP MAY NEED TO BE MODIFIED.
2. CHIP COMPONENT FOOT PRINTS SHOWN FOR REFERENCE. FOR COMPONENT VALUES REFER TO TB-951+.
3. BOTTOM SIDE OF THE PCB IS CONTINUOUS GROUND PLANE.

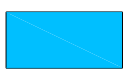

DENOTES PCB COPPER LAYOUT WITH SMOBC (SOLDER MASK OVER BARE COPPER)



DENOTES COPPER LAND PATTERN FREE OF SOLDER MASK

UNLESS OTHERWISE SPECIFIED	INITIALS		DATE
DIMENSIONS ARE IN INCHES TOLERANCES ON: 2 PL DECIMALS \pm 3 PL DECIMALS \pm .005 ANGLES \pm FRACTIONS \pm	DRAWN	GF	03/09/17
	CHECKED	IL	04/19/17
	APPROVED	RS	04/19/17



Mini-Circuits® 13 Neptune Avenue
Brooklyn NY 11235

PL, 04AM03, DF782, PHA-23HLN+,
TB-951+

THIS DOCUMENT AND ITS CONTENTS ARE THE PROPERTY OF MINI-CIRCUITS. EXCEPT FOR USE EXPRESSLY GRANTED, IN WRITING, TO ITS VENDORS, VENDEE AND THE UNITED STATES GOVERNMENT, MINI-CIRCUITS RESERVES ALL PROPRIETARY DESIGN, USE, MANUFACTURING AND REPRODUCTION RIGHTS THERETO. THESE CONTENTS SHALL NOT BE USED, DUPLICATED OR DISCLOSED TO ANY OUTSIDE PARTY, IN WHOLE OR IN PART, WITHOUT WRITTEN PERMISSION OF MINI-CIRCUITS.

SIZE A	CODE IDENT 15542	DRAWING NO: 98-PL-512	REV: OR
FILE: 98PL512	SCALE: 5:1	SHEET: 1 OF 1	

Evaluation Board and Circuit

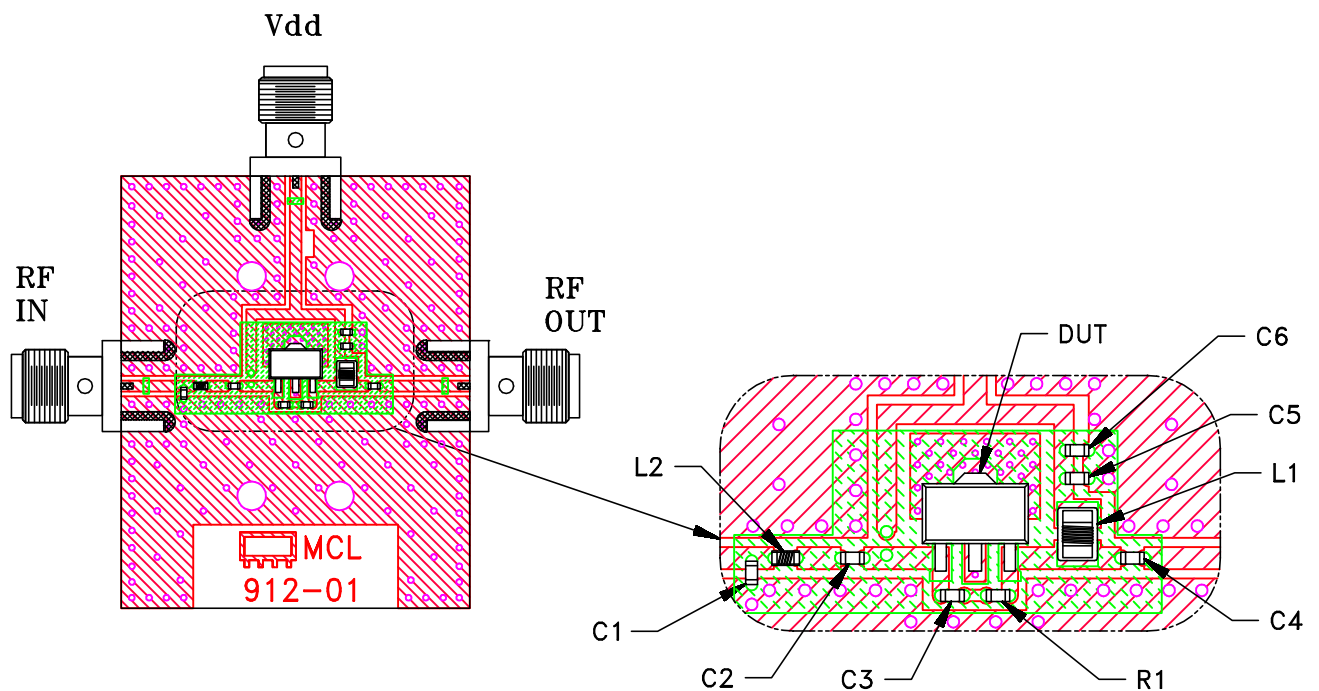

TB-951-23LN+

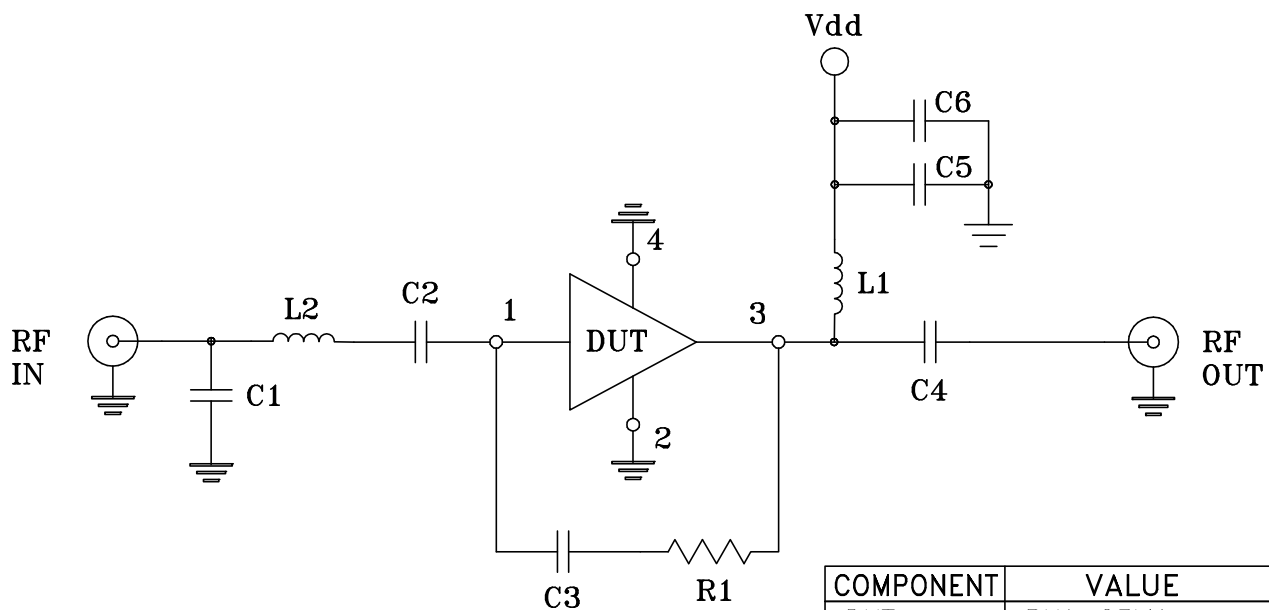

Schematic Diagram

COMPONENT	VALUE	SIZE
DUT	PHA-23LN+	SOT-89
C1	Capacitor 1.2 pF	0402
C2,C3,C6	Capacitor 0.1 uF	
C4	Capacitor 0.001 uF	
C5	Capacitor 0.01 uF	
R1	Resistor 1.21 KOhm	
L1	Inductor 0.680 uH	0805
L2	Inductor 1.0 nH	0402

Notes:

1. 50 Ohm SMA Female connectors.
2. PCB Material: R04350 or equivalent,
Dielectric Constant=3.5, Thickness=.020 inch.

 **Mini-Circuits®**



All Mini-Circuits products are manufactured under exacting quality assurance and control standards, and are capable of meeting published specifications after being subjected to any or all of the following physical and environmental test.

Specification	Test/Inspection Condition	Reference/Spec
Operating Temperature	-40° to 95° C / 105° C Ambient Environment	Individual Model Data Sheet
Storage Temperature	-55° to 100° C or -65° to 150° Ambient Environment	Individual Model Data Sheet
Thermal Shock	-55° to 100°C, 100 cycles	MIL-STD-202, Method 107, Condition A-3, except +100°C
Mechanical Shock	1.5Kg, 0.5 ms, 5 shock pulses, Y1 direction only	MIL-STD-883, Method 2002, Condition B, except Y1 direction only
Vibration (Variable Frequency)	50g peak	MIL-STD-883, Method 2007, Condition B
Autoclave	15 psig, 100% RH, 121°C, 96 hours	JESD22-A102-C, Condition C
HAST	130°C, 85% RH, 96 hours	JESD22-A110
Solderability	10X Magnification	J-STD-002, Para 4.2.5, Test S, 95% Coverage
Solder Reflow Heat	Sn-Pb Eutetic Process: 240°C peak Pb-Free Process: 260°C peak	J-STD-020C, Table 4-1, 4-2 and 5-2; Figure 5-1
Moisture Sensitivity: Level 1	Bake at 125°C for 24 hours. Soak at 85°C/85%RH for 168 hours Reflow 3 cycles at 260°C peak	J-STD-020
Marking Resistance to Solvents	Isopropyl alcohol + mineral spirits at 25°C; terpene defluxer at 25°C; distilled water + proylene glycol monomethyl ether +	MIL-STD-202, Method 215



All Mini-Circuits products are manufactured under exacting quality assurance and control standards, and are capable of meeting published specifications after being subjected to any or all of the following physical and environmental test.

Specification	Test/Inspection Condition	Reference/Spec
	monoethanolamine at 63°C to 70°C	