

Ultra High Dynamic Range Monolithic Amplifier Die

PHA-23HLN-D+

50Ω 30 MHz to 2 GHz

The Big Deal

- Ultra-High IP3, +44.4 dBm typ.
- Medium Power, +28.4dBm typ.
- Excellent Noise Figure, 1.4 dB typ.
- Operates over wide DC inpuite: +3 to +8V

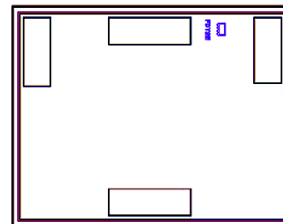

Product Overview

PHA-23HLN-D+ (RoHS compliant) is an advanced wideband amplifier Die fabricated using E-PHEMT technology and offers extremely high dynamic range over a broad frequency range and with low noise figure. In addition, the PHA-23HLN-D+ has good input and output return loss over a broad frequency range.

Key Features

Feature	Advantages
Broad Band: 30 MHz to 2 GHz	Broadband covering primary wireless communications bands: Cellular, VHF, UHF
Extremely High IP3 40.9 dBm typical at 30MHz 44.4 dBm typical at 1GHz	The PHA-23HLN-D+ matches industry leading IP3 performance relative to device size and power consumption. The combination of the design and E-PHEMT Structure provides enhanced linearity over a broad frequency range as evidence in the IP3 being approximately 14-17 dB above the P1dB point. This feature makes this amplifier ideal for use in: <ul style="list-style-type: none"> • Driver amplifiers for complex waveform up converter paths • Drivers in linearized transmit systems • Secondary amplifiers in ultra-High Dynamic range receivers
Low Noise Figure: 1.4dB at 1 GHz	Enables lower system noise figure performance
High P1dB 28.4 dBm at 1 GHz	High P1dB, High OIP3, Low NF results in a very dynamic range preventing amplifier saturation under strong interfering signals. It can also be used to drive mixers requiring high drive
Unpackaged Die	Enables the user to integrate the amplifier directly into hybrids

Ultra High Dynamic Range Monolithic Amplifier Die

PHA-23HLN-D+

50Ω 30 MHz to 2 GHz

Product Features

- High IP3, 44.4 dBm typ. at 1GHz
- Gain, 21.3 dB typ. at 1 GHz
- High Pout, P1dB 28.4 dBm typ. at 1GHz
- Low noise figure, 1.4 dB at 1 GHz
- Operates over wide DC input: +3 to +8V

Typical Applications

- Base station infrastructure
- CATV
- Cellular

General Description

PHA-23HLN-D+ (RoHS compliant) is an advanced wideband amplifier Die fabricated using E-PHEMT technology and offers extremely high dynamic range over a broad frequency range and with low noise figure. In addition, the PHA-23HLN-D+ has good input and output return loss over a broad frequency range.

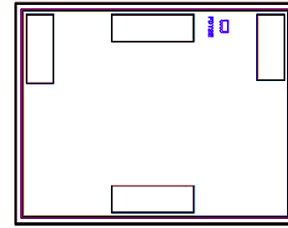

+RoHS Compliant

The +Suffix identifies RoHS Compliance. See our web site for RoHS Compliance methodologies and qualifications

Ordering Information: Refer to Last Page

Simplified Schematic and Pad description

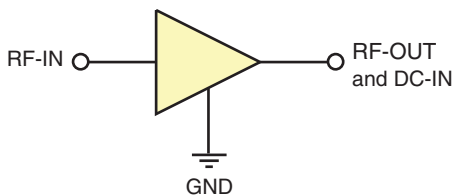

Pad#	Function	Description
2	RF-IN	RF input pad. This pad requires the use of an external DC blocking capacitor.
4	RF-OUT & DC-IN	RF output pad and bias pad. DC voltage is present on this pad, therefore, a DC blocking capacitor is necessary for proper operation. An RF choke is needed to feed DC bias without loss of RF signal due to the bias connection.
1,3 & Bottom of Die	Ground (GND)	Ground

Bonding Pad Position

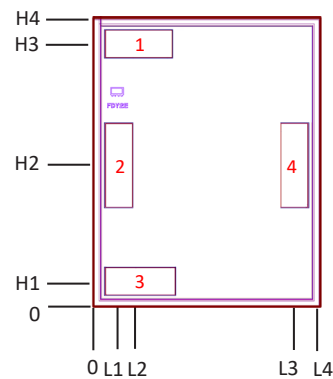

Dimensions in μm, Typical

L1	L2	L3	L4	H1	H2	H3	H4	Thickness	Pad#1 Ground Size	Pad#3 Ground Size	RF In & RF Out + DC Pad
85.5	160.5	704.5	790	85.5	495.2	924.5	1010	100	240 X 90	230 x 90	90 x 290

Note: 1. Bond Pad material - Gold
2. Bottom of Die - Gold plated

Electrical Specifications^{1,2} at 25°C and 4V, unless noted

Parameter	Condition (GHz)	Vd=8V ¹			Vd=5V ¹			Vd=3V ¹	Units
		Min.	Typ.	Max.	Min.	Typ.	Max.		
Frequency Range		30		2000	30		2000	30-2000	MHz
Gain	30		23.2			23.0		22.3	dB
	500		22.1			21.9		21.0	
	1000		21.3			21.0		19.7	
	1500		20.6			20.1		18.5	
	2000		19.5			18.9		17.0	
Input Return Loss	30		11.9			12.0		12.4	dB
	500		11.7			11.6		10.5	
	1000		9.9			9.4		7.5	
	1500		10.3			9.6		7.7	
	2000		9.5			8.9		6.9	
Output Return Loss	30		14.8			14.9		16.6	dB
	500		14.5			16.5		21.0	
	1000		14.2			18.8		18.0	
	1500		10.6			12.2		10.8	
	2000		8.2			9.4		8.5	
Reverse isolation	1000		27.5			27.2		26.9	dB
Output Power @ 1 dB compression	30		26.2			22.8		17.4	dBm
	500		28.1			24.1		19.0	
	1000		28.4			23.9		18.8	
	1500		28.0			23.4		18.4	
	2000		27.8			23.3		18.0	
Output IP3 ²	30		40.9			40.9		34.7	dBm
	500		43.6			39.3		33.3	
	1000		44.4			37.4		30.9	
	1500		45.8			36.3		30.5	
	2000		42.5			35.6		29.7	
Noise Figure	30		1.3			1.1		1.1	dB
	500		1.2			1.0		1.0	
	1000		1.4			1.2		1.2	
	1500		1.5			1.3		1.3	
	2000		1.9			1.6		1.6	
Device Operating Voltage			8.0			5.0		3.0	V
Device Operating Current		—	235	—		141.7	162	72.4	mA
Device Current Variation vs. Temperature ³			-209.8			14.2		33.1	µA/°C
Device Current Variation vs Voltage			0.0254			0.0354		0.0354	mA/mV
Thermal Resistance, junction-to-ground lead Junction-to-ground lead at 85°C stage temperature			23.3			23.3		23.3	°C/W

1. Measured on Mini-Circuits Characterization test board TB-951+, Die packaged in industry standard SOT-89 package and soldered on TB-951+. See Characterization Test Circuit (Fig. 1)

2. Tested at Pout= 0 dBm / tone.

3. (Current at 85°C — Current at -45°C)/130

Absolute Maximum Ratings⁴

Parameter	at 8V	at 3V	at 5V
Operating Temperature (ground lead)	-40°C to 95°C	-40°C to 105°C	-40°C to 105°C
Power Dissipation ⁵	3.3W	3.3W	3.3W
Input Power (CW)	+22 dBm (5 minutes max) ⁶ +11 dBm (continuous) for 0.03-1GHz +18 dBm (continuous) for 1-2 GHz	+22 dBm (5 minutes max) ⁶ +4 dBm (continuous) for 0.03-1GHz +12 dBm (continuous) for 1-2 GHz	+22 dBm (5 minutes max) ⁶ +8 dBm (continuous) for 0.03-1GHz +15 dBm (continuous) for 1-2 GHz
DC Voltage on Pad 4	10V	10V	10V

4. Permanent damage may occur if any of these limits are exceeded.

Electrical maximum ratings are not intended for continuous normal operation.

5. Up to 85°C, derate linearly to 3W at 95°C.

6. Up to 85°C, derate linearly to +19dBm at 95°C.

Characterization Test / Recommended Application Circuit

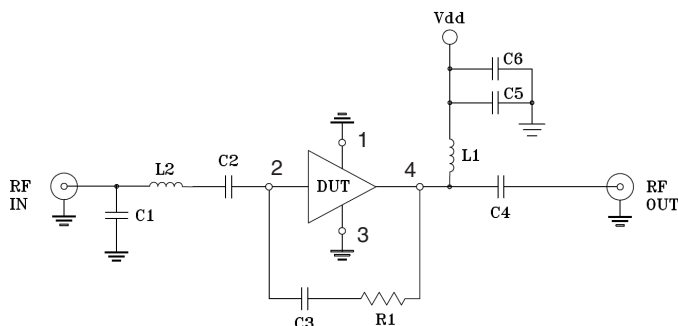

Component	Size	Value	Manufacturer	P/N
C1		1.2pF	Murata	GRM1555C1H1R2WA01D
C2,C3,C6	0402	0.1uF		GRM155R71C104KA88D
C4		0.001uF		GRM1555C1H120JA01D
C5		0.01uF		GRM155R71E103KA01D
R1			1.21KOhm	KOA
L1	0805	0.68uH	Coilcraft	0805LS-681XJLB
L2	0402	1nH		0402CS-1N0XJLW

Fig 1. Block Diagram of Test Circuit used for characterization. (DUT, Die packaged in SOT-89 package, soldered on Mini-Circuits Characterization test board TB-951+) Gain, Return loss, Output power at 1dB compression (P1 dB) , output IP3 (OIP3) and noise figure measured using Agilent's N5242A PNA-X microwave network analyzer.

Conditions:

1. Gain and Return loss: Pin= -25dBm.

Output IP3 (OIP3): Two tones, spaced 1 MHz apart, 0 dBm/tone at output.

Assembly Diagram

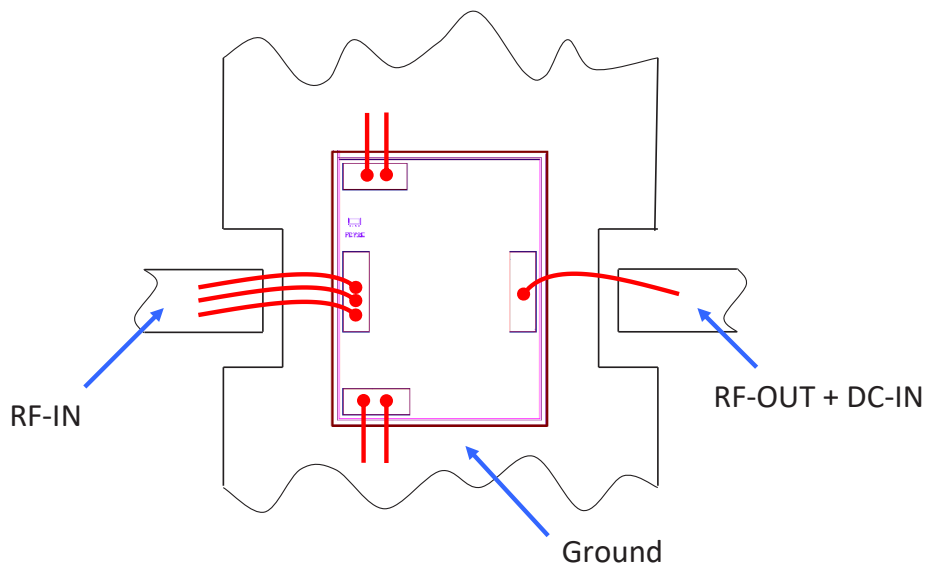

Assembly and Handling Procedure

- 1. Storage**
Dice should be stored in a dry nitrogen purged desiccators or equivalent.
- 2. ESD**
MMIC E-PHEMT amplifier dice are susceptible to electrostatic and mechanical damage. Die are supplied in antistatic protected material, which should be opened in clean room conditions at an appropriately grounded anti-static workstation. Devices need careful handling using correctly designed collets, vacuum pickup tips or sharp antistatic tweezers to deter ESD damage to dice.
- 3. Die Attach**
The die mounting surface must be clean and flat. Using conductive silver filled epoxy, recommended epoxies are DieMat DM6030HK-PT/H579 or Ablestik 84-1LMISR4. Apply sufficient epoxy to meet required epoxy bond line thickness, epoxy fillet height and epoxy coverage around total die periphery. Parts shall be cured in a nitrogen filled atmosphere per manufacturer's cure condition. It is recommended to use antistatic die pick up tools only.
- 4. Wire Bonding**
Bond pad openings in the surface passivation above the bond pads are provided to allow wire bonding to the dice gold bond pads. Thermosonic bonding is used with minimized ultrasonic content. Bond force, time, ultrasonic power and temperature are all critical parameters. Suggested wire is pure gold, 1 mil diameter. Bonds must be made from the bond pads on the die to the package or substrate. All bond wires should be kept as short as low as reasonable to minimize performance degradation due to undesirable series inductance.

Additional Detailed Technical Information <i>additional information is available on our dash board.</i>	
Performance Data	Data Table
	Swept Graphs
	S-Parameter (S2P Files) Data Set with and without port extension(.zip file)
Case Style	Die
Die Ordering and packaging information	Quantity, Package Model No.
	Small, Gel - Pak: 5,10,50,100 KGD* PHA-23HLN-DG+ Medium†, Partial wafer: KGD*<1670K PHA-23HLN-DP+ Large†, Full Wafer PHA-23HLN-DF+
	†Available upon request contact sales representative
	Refer to AN-60-067
Environmental Ratings	ENV80

*Known Good Dice ("KGD") means that the dice in question have been subjected to Mini-Circuits DC test performance criteria and measurement instructions and that the parametric data of such dice fall within a predefined range. While DC testing is not definitive, it does help to provide a higher degree of confidence that dice are capable of meeting typical RF electrical parameters specified by Mini-Circuits.

ESD Rating**

Human Body Model (HBM): Class 1B (pass 500V) in accordance with ANSI/ESD STM 5.1 - 2001

** Tested in industry standard SOT-89 package.

Additional Notes

- A. Performance and quality attributes and conditions not expressly stated in this specification document are intended to be excluded and do not form a part of this specification document.
- B. Electrical specifications and performance data contained in this specification document are based on Mini-Circuit's applicable established test performance criteria and measurement instructions.
- C. The parts covered by this specification document are subject to Mini-Circuits standard limited warranty and terms and conditions (collectively, "Standard Terms"); Purchasers of this part are entitled to the rights and benefits contained therein. For a full statement of the Standard Terms and the exclusive rights and remedies thereunder, please visit Mini-Circuits' website at www.minicircuits.com/MCLStore/terms.jsp
- D. Mini-Circuits does not warrant the accuracy or completeness of the information, text, graphics and other items contained within this document and same are provided as an accommodation and on an "As is" basis, with all faults.
- E. Purchasers of this part are solely responsible for proper storing, handling, assembly and processing of Known Good Dice (including, without limitation, proper ESD preventative measures, die preparation, die attach, wire bonding and related assembly and test activities), and Mini-Circuits assumes no responsibility therefor or for environmental effects on Known Good Dice.
- F. Mini-Circuits and the Mini-Circuits logo are registered trademarks of Scientific Components Corporation d/b/a Mini-Circuits. All other third-party trademarks are the property of their respective owners. A reference to any third-party trademark does not constitute or imply any endorsement, affiliation, sponsorship, or recommendation by any such third-party of Mini-Circuits or its products.

Typical Performance Data

NOTE: Use PDF Bookmarks to view DATA at required conditions

Definitions:

- Input Return Loss = -S11 (dB)
- Gain(Power Gain) = S21 (dB)
- Reverse Isolation = -S12 (dB)
- Output Return Loss = -S22 (dB)

TEST CONDITIONS: Vd = 8.00V, Id = 237.09mA @ Temperature = +25°C

FREQ	Gain	Isolation	Input Return Loss	Output Return Loss	Stability		IP-3 Output	1dB Comp. Output	Noise Figure
					K	Measure			
(MHz)	(dB)	(dB)	(dB)	(dB)	K	Measure	(dBm)	(dBm)	(dB)
20	23.67	26.69	10.58	14.62	1.02	0.49	41.79	25.95	1.40
30	23.31	26.22	11.50	14.37	1.02	0.46	43.87	25.94	1.33
40	23.07	26.00	11.87	13.73	1.03	0.45	44.26	27.63	1.26
50	22.92	25.88	12.15	13.36	1.03	0.44	43.82	27.42	1.20
60	22.82	25.83	12.29	13.16	1.03	0.44	44.08	27.35	1.27
70	22.75	25.79	12.36	13.02	1.04	0.44	44.25	27.16	1.21
80	22.71	25.76	12.45	12.94	1.04	0.44	44.57	28.04	1.19
90	22.67	25.74	12.45	12.87	1.04	0.44	45.00	27.72	1.20
100	22.65	25.73	12.49	12.83	1.04	0.44	45.03	27.54	1.24
150	22.57	25.73	12.50	12.80	1.04	0.45	44.37	27.63	1.22
200	22.51	25.76	12.40	12.90	1.05	0.46	44.29	27.80	1.20
250	22.46	25.80	12.27	13.02	1.05	0.47	44.06	27.92	1.25
300	22.41	25.85	12.12	13.18	1.05	0.49	44.84	27.91	1.28
350	22.36	25.92	11.97	13.38	1.06	0.50	44.27	28.02	1.27
400	22.30	26.00	11.78	13.56	1.06	0.52	44.67	27.98	1.25
450	22.24	26.08	11.62	13.82	1.07	0.54	45.11	28.08	1.24
500	22.18	26.18	11.42	14.03	1.07	0.56	44.64	28.02	1.29
550	22.12	26.28	11.27	14.27	1.08	0.59	45.64	27.99	1.31
600	22.05	26.39	11.07	14.47	1.09	0.61	45.94	28.12	1.32
650	21.97	26.52	10.89	14.66	1.10	0.63	46.16	27.94	1.33
700	21.89	26.65	10.71	14.78	1.11	0.65	46.00	28.12	1.25
750	21.81	26.79	10.59	14.88	1.12	0.67	46.38	28.15	1.36
800	21.73	26.95	10.46	14.90	1.13	0.70	46.69	28.17	1.29
850	21.65	27.10	10.37	14.90	1.14	0.72	48.23	27.91	1.34
900	21.58	27.25	10.24	14.83	1.15	0.73	48.71	27.98	1.37
950	21.51	27.41	10.12	14.69	1.17	0.75	47.77	28.31	1.30
1000	21.43	27.58	10.01	14.47	1.18	0.77	45.44	28.20	1.35
1100	21.27	27.94	9.93	13.86	1.21	0.79	48.58	27.88	1.40
1200	21.11	28.33	9.92	13.16	1.25	0.82	48.83	27.96	1.46
1300	20.95	28.74	10.00	12.42	1.29	0.83	50.43	28.13	1.43
1400	20.79	29.16	10.16	11.68	1.33	0.85	53.49	27.76	1.51
1500	20.63	29.60	10.39	10.99	1.38	0.86	50.19	27.69	1.55
1600	20.46	30.06	10.61	10.35	1.43	0.87	51.48	27.70	1.60
1700	20.29	30.52	10.71	9.77	1.48	0.88	50.27	27.50	1.62
1800	20.08	31.01	10.58	9.25	1.53	0.89	52.70	27.54	1.65
1900	19.83	31.55	10.13	8.78	1.59	0.91	52.98	27.58	1.77
2000	19.54	32.11	9.33	8.34	1.64	0.94	49.49	27.40	1.86
2100	19.18	32.66	8.32	7.95	1.68	0.97	48.95	27.29	2.01
2200	18.74	33.27	7.23	7.58	1.72	1.00	47.60	27.13	2.14
2300	18.23	33.84	6.16	7.26	1.75	1.04	49.87	26.90	2.33
2400	17.66	34.42	5.22	6.93	1.76	1.08	48.62	26.53	2.61
2500	17.01	34.98	4.41	6.64	1.77	1.12	51.59	26.84	2.84

Note: Test data of Die packaged in industry standard SOT-89 package



Typical Performance Data

Definitions:

Input Return Loss = -S11 (dB)

Gain(Power Gain) = S21 (dB)

Reverse Isolation = -S12 (dB)

Output Return Loss = -S22 (dB)

TEST CONDITIONS: Vd = 7.60V, Id = 227.04mA @ Temperature = +25°C

FREQ	Gain	Isolation	Input Return Loss	Output Return Loss	Stability		IP-3 Output	1dB Comp. Output	Noise Figure
					K	Measure			
(MHz)	(dB)	(dB)	(dB)	(dB)	K	Measure	(dBm)	(dBm)	(dB)
20	23.67	26.68	10.58	14.58	1.02	0.48	42.07	25.55	1.32
30	23.31	26.20	11.52	14.33	1.02	0.46	43.44	25.61	1.26
40	23.07	25.98	11.89	13.69	1.03	0.45	44.27	27.19	1.18
50	22.92	25.89	12.17	13.33	1.03	0.44	43.89	27.07	1.14
60	22.82	25.81	12.34	13.12	1.03	0.44	44.16	26.97	1.17
70	22.75	25.76	12.41	12.98	1.03	0.44	44.36	26.84	1.15
80	22.71	25.74	12.49	12.91	1.04	0.44	45.15	27.59	1.11
90	22.67	25.73	12.51	12.83	1.04	0.44	44.59	27.33	1.12
100	22.65	25.72	12.54	12.80	1.04	0.44	45.12	27.19	1.14
150	22.57	25.71	12.56	12.77	1.04	0.44	44.81	27.24	1.10
200	22.51	25.73	12.47	12.88	1.05	0.45	44.63	27.40	1.10
250	22.46	25.78	12.33	13.00	1.05	0.47	44.55	27.53	1.15
300	22.41	25.83	12.18	13.18	1.05	0.48	45.14	27.51	1.21
350	22.36	25.90	12.02	13.40	1.06	0.50	44.77	27.63	1.19
400	22.30	25.98	11.83	13.59	1.06	0.52	46.04	27.58	1.17
450	22.24	26.06	11.66	13.87	1.07	0.54	45.59	27.68	1.18
500	22.18	26.15	11.45	14.09	1.07	0.56	45.35	27.61	1.21
550	22.11	26.26	11.31	14.37	1.08	0.59	46.38	27.56	1.22
600	22.05	26.37	11.10	14.59	1.09	0.61	46.32	27.71	1.23
650	21.97	26.49	10.90	14.82	1.10	0.63	46.85	27.50	1.21
700	21.89	26.63	10.73	14.96	1.11	0.65	47.17	27.70	1.18
750	21.81	26.77	10.61	15.10	1.12	0.68	48.57	27.73	1.27
800	21.72	26.92	10.47	15.14	1.13	0.70	47.99	27.74	1.24
850	21.65	27.07	10.38	15.16	1.14	0.72	50.84	27.46	1.26
900	21.58	27.22	10.25	15.10	1.15	0.74	51.44	27.52	1.26
950	21.50	27.38	10.12	14.97	1.16	0.75	50.11	27.89	1.28
1000	21.43	27.55	10.01	14.75	1.18	0.77	46.29	27.83	1.31
1100	21.27	27.91	9.93	14.13	1.21	0.80	51.85	27.43	1.33
1200	21.10	28.29	9.91	13.40	1.25	0.82	50.37	27.57	1.36
1300	20.94	28.69	9.99	12.63	1.28	0.84	51.40	27.73	1.39
1400	20.78	29.10	10.14	11.87	1.33	0.85	48.58	27.33	1.41
1500	20.62	29.53	10.37	11.15	1.37	0.86	48.18	27.31	1.48
1600	20.46	29.99	10.60	10.50	1.43	0.87	48.09	27.31	1.51
1700	20.28	30.44	10.70	9.91	1.47	0.88	46.99	27.12	1.52
1800	20.08	30.89	10.59	9.38	1.52	0.89	47.25	27.12	1.57
1900	19.83	31.43	10.14	8.91	1.58	0.91	47.10	27.17	1.67
2000	19.53	31.96	9.35	8.47	1.63	0.94	47.05	27.01	1.76
2100	19.17	32.51	8.34	8.08	1.67	0.97	47.66	26.92	1.89
2200	18.74	33.09	7.24	7.71	1.70	1.01	46.46	26.77	2.04
2300	18.22	33.65	6.18	7.39	1.73	1.05	46.42	26.48	2.18
2400	17.65	34.23	5.23	7.07	1.74	1.09	44.59	26.13	2.47
2500	17.00	34.79	4.41	6.78	1.75	1.13	46.66	26.43	2.70

Note: Test data of Die packaged in industry standard SOT-89 package

Typical Performance Data

Definitions:

Input Return Loss = -S11 (dB)

Gain(Power Gain) = S21 (dB)

Reverse Isolation = -S12 (dB)

Output Return Loss = -S22 (dB)

TEST CONDITIONS: Vd = 8.40V, Id = 248.49mA @ Temperature = +25°C

FREQ	Gain	Isolation	Input Return Loss	Output Return Loss	Stability		IP-3 Output	1dB Comp. Output	Noise Figure
					K	Measure			
(MHz)	(dB)	(dB)	(dB)	(dB)	K	Measure	(dBm)	(dBm)	(dB)
20	23.66	26.71	10.61	14.67	1.03	0.49	41.25	26.31	1.47
30	23.30	26.23	11.49	14.45	1.02	0.47	42.11	26.25	1.38
40	23.05	26.02	11.86	13.80	1.03	0.46	43.01	28.04	1.28
50	22.91	25.89	12.03	13.43	1.03	0.45	43.25	27.72	1.23
60	22.81	25.85	12.23	13.22	1.03	0.45	43.17	27.69	1.31
70	22.74	25.80	12.32	13.08	1.04	0.44	44.26	27.47	1.26
80	22.69	25.78	12.39	13.01	1.04	0.44	43.43	28.45	1.21
90	22.66	25.77	12.39	12.93	1.04	0.44	44.00	28.06	1.24
100	22.64	25.76	12.42	12.90	1.04	0.44	44.16	27.89	1.26
150	22.55	25.75	12.43	12.86	1.04	0.45	43.60	28.00	1.29
200	22.50	25.78	12.35	12.95	1.05	0.46	43.84	28.16	1.22
250	22.45	25.82	12.22	13.06	1.05	0.48	43.61	28.28	1.25
300	22.40	25.88	12.05	13.22	1.05	0.49	44.20	28.27	1.27
350	22.35	25.94	11.91	13.41	1.06	0.51	43.68	28.39	1.30
400	22.29	26.02	11.72	13.57	1.06	0.53	44.32	28.34	1.28
450	22.23	26.10	11.58	13.82	1.07	0.55	44.19	28.44	1.29
500	22.17	26.20	11.38	14.01	1.08	0.57	44.25	28.40	1.32
550	22.11	26.30	11.22	14.23	1.08	0.59	45.13	28.38	1.33
600	22.04	26.42	11.03	14.40	1.09	0.61	44.74	28.49	1.32
650	21.96	26.54	10.85	14.57	1.10	0.63	44.94	28.33	1.32
700	21.88	26.68	10.68	14.66	1.11	0.65	45.33	28.49	1.28
750	21.80	26.82	10.55	14.74	1.12	0.68	45.66	28.53	1.39
800	21.72	26.97	10.42	14.73	1.13	0.70	45.59	28.56	1.34
850	21.64	27.12	10.35	14.72	1.14	0.72	46.38	28.33	1.36
900	21.57	27.28	10.21	14.63	1.16	0.73	46.66	28.39	1.40
950	21.50	27.44	10.10	14.48	1.17	0.75	46.46	28.68	1.37
1000	21.42	27.61	10.00	14.25	1.18	0.77	44.83	28.54	1.34
1100	21.26	27.98	9.92	13.65	1.21	0.79	46.29	28.27	1.43
1200	21.10	28.38	9.91	12.96	1.25	0.82	46.72	28.30	1.45
1300	20.94	28.79	10.00	12.23	1.29	0.83	46.74	28.48	1.45
1400	20.78	29.22	10.15	11.51	1.34	0.85	47.83	28.13	1.51
1500	20.62	29.66	10.38	10.83	1.39	0.86	47.33	28.04	1.58
1600	20.45	30.14	10.60	10.21	1.44	0.87	47.18	28.05	1.63
1700	20.27	30.62	10.70	9.64	1.49	0.88	47.14	27.84	1.65
1800	20.07	31.11	10.56	9.13	1.54	0.89	47.75	27.87	1.69
1900	19.82	31.67	10.10	8.66	1.60	0.91	47.53	27.93	1.79
2000	19.52	32.23	9.30	8.22	1.66	0.93	46.48	27.73	1.90
2100	19.16	32.80	8.29	7.83	1.70	0.96	46.25	27.64	2.04
2200	18.72	33.42	7.20	7.46	1.74	1.00	45.95	27.42	2.19
2300	18.21	33.99	6.14	7.13	1.76	1.04	46.59	27.26	2.33
2400	17.64	34.59	5.21	6.80	1.78	1.08	47.63	26.90	2.67
2500	16.99	35.15	4.39	6.51	1.78	1.11	50.61	27.18	2.91

Note: Test data of Die packaged in industry standard SOT-89 package

Typical Performance Curves

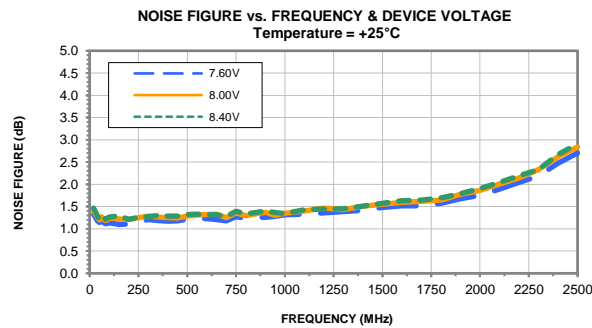
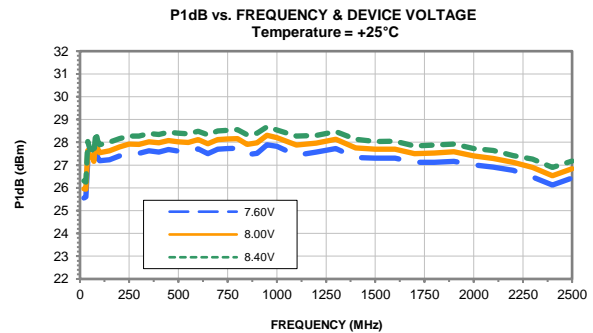
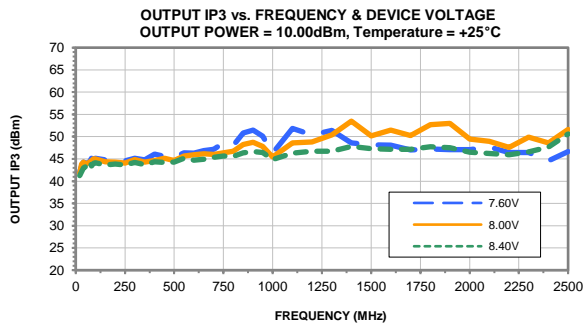
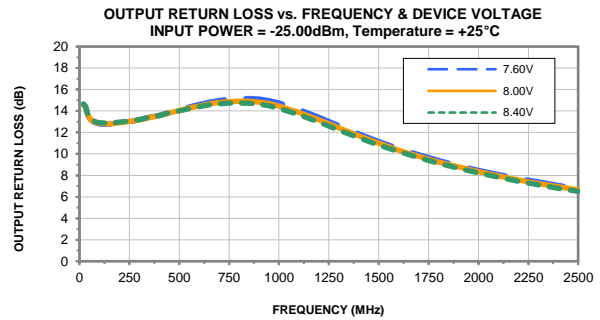
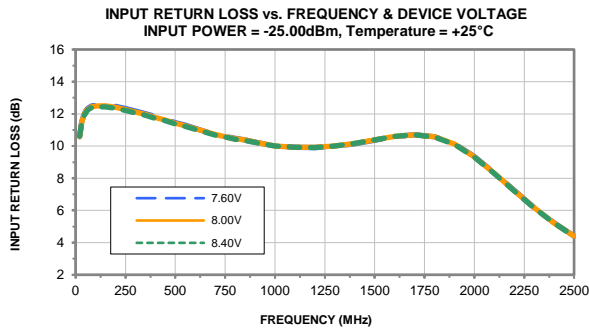
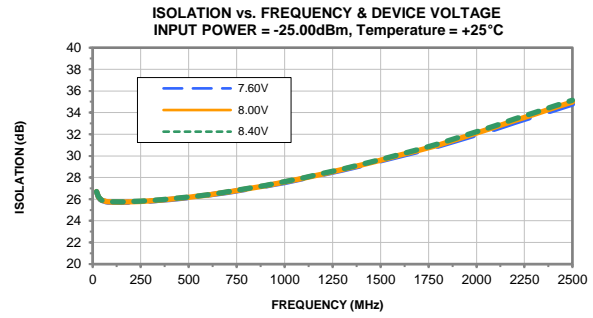
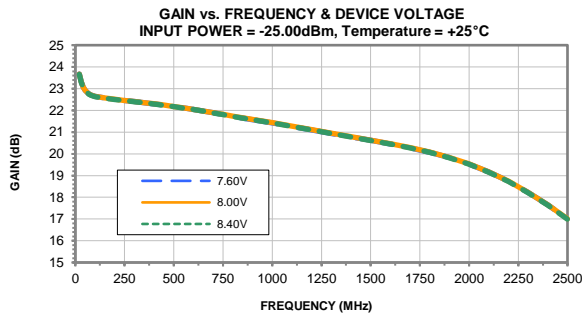

Note: Test data of Die packaged in industry standard SOT-89 package

All Mini-Circuits products are manufactured under exacting quality assurance and control standards, and are capable of meeting published specifications after being subjected to any or all of the following physical and environmental test.

Specification	Test/Inspection Condition	Reference/Spec
Operating Temperature	-40° to 85° C or -40° to 105° C or -55° to 105° C or -45° to 105° C Ambient Environment	Refer to Individual Model Data Sheet
Storage Environment (Die)	-65° to 150°C	Individual Model Data Sheet
Storage Environment(Packaging)	-40° to 70°C and 40 to 60% humidity (In Factory Shipped Package)	