

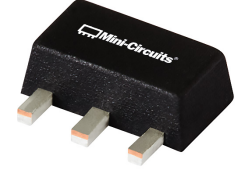

### THE BIG DEAL

- High IP3, +45.5 dBm Typ. at 100 MHz
- Gain, 15.6 dB Typ. at 100 MHz
- High Pout, P1dB +23.7 dBm Typ. at 100 MHz
- Low Noise Figure, 2.9 dB Typ. at 100 MHz



Generic photo used for illustration purposes only

CASE STYLE: DF782

### +RoHS Compliant

The +Suffix identifies RoHS Compliance. See our website for methodologies and qualifications

### APPLICATIONS

- CATV, DOCSIS 3.1/WLAN

### PRODUCT OVERVIEW

PGA-32-75+ (RoHS compliant) is an advanced wideband Amplifier fabricated using E-PHEMT technology and offers extremely high dynamic range over a broad frequency range with low Noise Figure and flat Gain. It has repeatable performance from lot to lot and is enclosed in a SOT-89 package for very good thermal performance.

### KEY FEATURES

Feature	Advantages
Broadband: 5 to 300 MHz	5 to 300 MHz bandwidth covers primary CATV applications such as DOCSIS 3.1.
High IP3 Versus DC Power Consumption: +45.5 dBm Typ. at 100 MHz	The PGA-32-75+ matches industry leading IP3 performance relative to device size and power consumption. The combination of the design and E-PHEMPT structure provides enhanced linearity over a broad frequency range as evident in the IP3 being typically 15-20 dB above the P1dB point. This feature makes this Amplifier ideal for use in CATV applications.
High IP2, +58.1 dBm Typ. at 100 MHz	Suppresses second order product on wideband applications such as CATV.
Low Noise Figure, 2.9 dB Typ. at 100 MHz	Low Noise Figure performance in combination with the high output IP3 results in high dynamic range.



## ELECTRICAL SPECIFICATIONS AT +25°C, 75Ω, UNLESS NOTED OTHERWISE

Parameter	Condition (MHz)	TB-966+				TB-916+		Units
		VDD=+9V <sup>1</sup>		VDD=+5V <sup>1</sup>		VDD=+9V <sup>2</sup>	VDD=+5V <sup>2</sup>	
		Min.	Typ.	Max.	Typ.	Typ.	Typ.	
Frequency Range		5		300	5-300	5-150	5-150	MHz
Gain	5		15.8		15.3	15.8	15.3	dB
	10		15.7		15.2	15.8	15.2	
	100	14.0	15.6	17.2	15.1	15.7	15.2	
	150		15.6		15.1	15.6	15.1	
	200		15.5		15.0	—	—	
	300		15.4		14.9	—	—	
Gain Flatness	5-150		—		—	±0.1	±0.1	dB
	5-300		±0.2		±0.2	—	—	
Input Return Loss	5		13.9		13.4	20.3	18.9	dB
	10		18.2		17.1	19.8	17.5	
	100		22.4		19.8	20.6	18.4	
	150		22.6		19.7	20.7	18.5	
	200		22.4		19.5	—	—	
	300		21.6		18.8	—	—	
Output Return Loss	5		19.8		19.1	19.3	20.0	dB
	10		25.2		23.9	22.5	21.7	
	100		28.4		25.9	23.5	22.0	
	150		26.0		23.8	22.7	21.2	
	200		24.0		21.8	—	—	
	300		18.9		17.4	—	—	
Reversed Isolation	100		20.6		20.5	20.6	20.4	dB
Output Power at 1 dB Compression	5		+20.4 (+69.1)		+19.0 (+67.8)	+23.2 (72)	+18.5 (67.2)	dBm (dBmV)
	10		+21.7 (+70.4)		+18.6 (+67.3)	+23.5 (72.2)	+18.7 (67.4)	
	100		+23.7 (+72.5)		+18.7 (+67.4)	+23.5 (72.3)	+18.5 (67.3)	
	150		+23.7 (+72.4)		+18.6 (+67.3)	+23.6 (72.3)	+18.5 (67.2)	
	200		+23.7 (+72.4)		+18.5 (+67.3)	—	—	
	300		+23.6 (+72.4)		+18.3 (+67.1)	—	—	
Output Third-Order Intercept Point	5		+43.2		+36.8	+44.5	+37.6	dBm
	10		+43.9		+37.3	+44.7	+38.7	
	100		+43.3		+39.1	+45.5	+39.9	
	150		+43.7		+39.1	+45.9	+39.7	
	200		+43.8		+39.1	—	—	
	300		+43.8		+37.7	—	—	
Output Second-Order Intercept Point	5		+57.3		+43.1	+59.6	+45.2	dBm
	10		+58.1		+43.2	+59.1	+44.3	
	100		+57.2		+44.4	+58.1	+44.8	
	150		+56.3		+44.1	+57.0	+44.2	
	200		+55.7		+44.2	—	—	
	300		+56.1		+45.6	—	—	
Noise Figure	5		—		—	—	—	dB
	10		3.8		3.4	3.8	3.4	
	100		2.9		2.7	2.9	2.8	
	150		2.8		2.7	2.8	2.7	
	200		2.9		2.7	—	—	
	300		2.9		2.8	—	—	
Operating Voltage (VDD)			9		5	9	5	V
Operating Current (IDD)			110	140	54	110	55	mA
Current Variation Vs. Temperature <sup>4</sup>			-2.2		6.5	-2.2	6.5	μA/°C
Current Variation Vs. Voltage <sup>5,6</sup>			0.014		0.013	0.014	0.013	mA/mV
Thermal Resistance, Junction-to-Ground Lead (θJC)			30		30	30	30	°C/W

1. Measured on Mini-Circuits Characterization Board TB-966+. See Characterization Test and Application Circuit (TB-966+) (Fig.1A)

2. Measured on Mini-Circuits Characterization Board TB-916+. See Characterization Test and Application Circuit (TB-916+) (Fig.1B)

3. OIP2 measured at sum frequencies of the two Tones (Frequency Measured = F1 + F2).

4. Device Current Variation Vs. Temperature = (Current in mA at 85°C - Current in mA at -45°C) / 130°C

5. Device Current Variation Vs. Voltage = (Current in mA at +9.5V - Current in mA at +8.5V) / ((+9.5V-8.5V)\*1000mA/mV)

6. Device Current Variation Vs. Voltage = (Current in mA at +5.25V - Current in mA at +4.75V) / ((+5.25V-4.75V)\*1000mA/mV)



### ABSOLUTE MAXIMUM RATINGS<sup>5</sup>

Parameter	Ratings
Operating Temperature (ground lead)	-40°C to +85°C
Storage Temperature	-65°C to +150°C
Power Dissipation	2.2 W
Input Power (CW)	+23 dBm (5 minutes max) +24 dBm (continuous)
DC Voltage on Pin 3	+11 V

5. Permanent damage may occur if any of these limits are exceeded. Electrical maximum ratings are not intended for continuous normal operation.

### SIMPLIFIED SCHEMATIC AND PAD DESCRIPTION

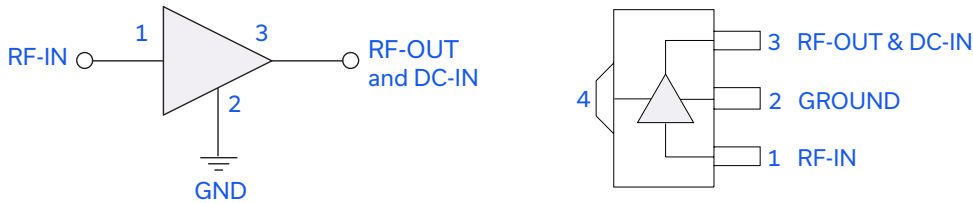

Function	Pin Number	Description
RF-IN	1	RF Input pin. This pin requires the use of an external DC blocking capacitor chosen for the frequency of operation. See Figure 1A & 1B
RF-OUT and DC-IN	3	RF Output and Bias pin. DC voltage is present on this pin; therefore a DC blocking capacitor is necessary for proper operation. An RF choke is needed to feed DC bias without loss of RF signal due to the bias connection. See Figure 1A & 1B
GND	2,4	Connections to ground. Use via holes as shown in "Suggested Layout for PCB Design" to reduce ground path inductance for best performance.

### CHARACTERIZATION TEST AND APPLICATION CIRCUIT (TB-966+)

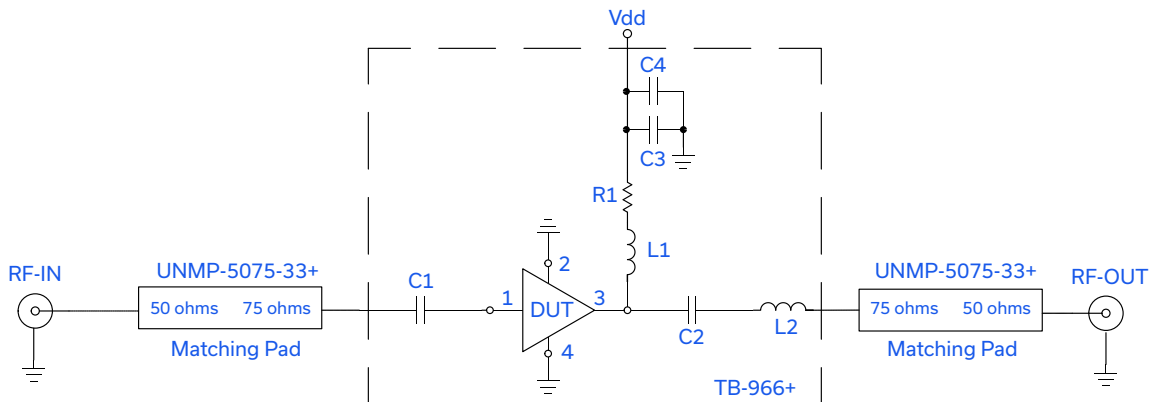

Fig 1A. Characterization Test and Application Circuit (DUT soldered on TB-966+). Gain, Return Loss, Output Power at 1dB Compression (P1dB), Output IP3 (OIP3), Output IP2 (OIP2) and Noise Figure measured using Agilent's N5242A PNA-X Microwave Network Analyzer & E5071C ENA Series Network Analyzer.

Conditions:

1. Gain and Return Loss:  $P_{IN} = -25\text{dBm}$
2. Output IP3 (OIP3): Two Tones, spaced 1 MHz apart, +5dBm/Tone at output.
3. Output IP2 (OIP2): Two Tones, spaced 1 MHz apart, +5dBm/Tone at output.

COMPONENT	P/N	VALUE	SIZE
DUT	PGA-32-75+	—	SOT-89
C1,C4	GRM155R71C104KA88D	0.1uF	0402
C2	GRM155R71E103KA01D	0.01uF	0402
C3	GRM1555C1H102JA01D	0.001uF	0402
L1	LQH32MN6R8K23L	6800nH	1210
L2	LQW15AN12NH00D	12nH	0402
R1	RK73H1JTTD4R99F	4.99 Ohm	0603



### CHARACTERIZATION TEST AND APPLICATION CIRCUIT (TB-916+)

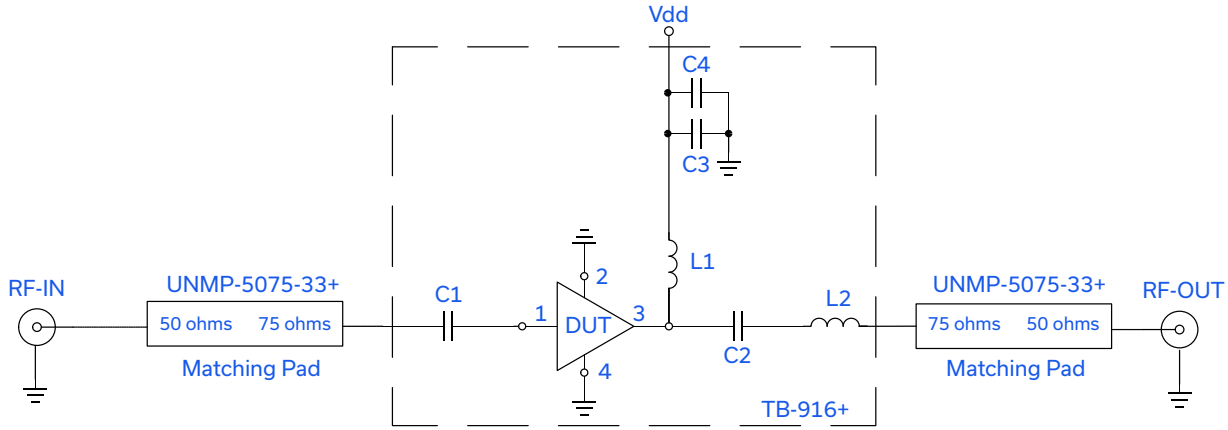

Fig 1B. Characterization Test and Application Circuit (DUT soldered on TB-916+). Gain, Return Loss, Output Power at 1dB Compression (P1dB), Output IP3 (OIP3), Output IP2 (OIP2) and Noise Figure measured using Agilent's N5242A PNA-X Microwave Network Analyzer & E5071C ENA Series Network Analyzer.

Conditions:

1. Gain and Return Loss:  $P_{IN} = -25\text{dBm}$
2. Output IP3 (OIP3): Two Tones, spaced 1 MHz apart, +5 dBm/Tone at output.
3. Output IP2 (OIP2): Two Tones, spaced 1 MHz apart, +5 dBm/Tone at output.

COMPONENT	SUPPLIER P/N	VALUE	SIZE
DUT	PGA-32-75+	—	SOT-89
C1	GRM32ER7YA106KA12L	10uF	1210
C2	GRM155R71E103KA01D	0.01uF	0402
C3	GRM1555C1H102JA01D	0.001uF	0402
C4	GRM155R71C104KA88D	0.1uF	0402
L1	1008CS-682XJLC	6.8uH	1008
L2	LQW15AN12NH00D	12nH	0402

### PRODUCT MARKING

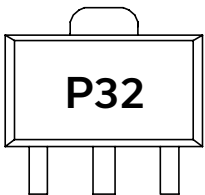

Marking may contain other features or characters for internal lot control



ADDITIONAL DETAILED TECHNICAL INFORMATION IS AVAILABLE ON OUR DASHBOARD. [CLICK HERE](#)

Performance Data	Data Table Swept Graphs S-Parameter (S2P Files) Data Set (.zip file)
5-200 MHz Operation	See Application Note (AN-060-087)
Case Style	DF782 (SOT 89) Plastic package, exposed paddle lead finish: Matte-Tin
Tape & Reel Standard quantities available on reel	F55 7" reels with 20, 50, 100, 200, 500 or 1K devices
Suggested Layout for PCB Design	PL-521
Evaluation Board	TB-966+ (5-300 MHz) & TB-916+ (5-150 MHz)
Environmental Ratings	ENV08T1

### ESD RATING

Human Body Model (HBM): Class 1A (+250V to < +500V) in accordance with ANSI/ESD STM 5.1 - 2001

Machine Model (MM): Class M1 (+25V) in accordance with ANSI/ESD STM5.2-1999

### MSL RATING

Moisture Sensitivity: MSL1 in accordance with IPC/JEDEC J-STD-020D

#### NOTES

- A. Performance and quality attributes and conditions not expressly stated in this specification document are intended to be excluded and do not form a part of this specification document.
- B. Electrical specifications and performance data contained in this specification document are based on Mini-Circuit's applicable established test performance criteria and measurement instructions.
- C. The parts covered by this specification document are subject to Mini-Circuits standard limited warranty and terms and conditions (collectively, "Standard Terms"); Purchasers of this part are entitled to the rights and benefits contained therein. For a full statement of the standard. Terms and the exclusive rights and remedies thereunder, please visit Mini-Circuits' website at [www.minicircuits.com/MCLStore/terms.jsp](http://www.minicircuits.com/MCLStore/terms.jsp)

## Typical Performance Data

**TB-966+**

**Definitions:**

Input Return Loss = -S11 (dB)

Gain(Power Gain) = S21 (dB)

Reverse Isolation = -S12 (dB)

Output Return Loss = -S22 (dB)

TEST CONDITIONS: Vd = 7.00V, Icc = 82.77mA @ Temperature = +25°C

FREQ	Gain	Isolation	Input Return Loss	Output Return Loss	Stability		IP-3 Output	1dB Comp. Output	Noise Figure
					K	Measure			
(MHz)	(dB)	(dB)	(dB)	(dB)			(dBm)	(dBm)	(dB)
1	14.20	25.55	2.95	4.49	1.13	0.68	--	18.97	--
3	15.70	21.15	9.96	14.89	1.14	0.72	40.14	21.21	--
5	15.64	20.71	13.75	19.69	1.15	0.70	40.80	21.42	--
10	15.52	20.67	18.02	24.29	1.17	0.69	40.55	21.32	3.51
20	15.53	20.60	20.24	27.59	1.17	0.69	41.80	21.35	3.12
30	15.52	20.59	20.98	28.56	1.17	0.69	42.52	21.39	2.97
40	15.52	20.60	21.30	28.84	1.17	0.69	43.18	21.58	2.93
50	15.51	20.61	21.38	28.90	1.17	0.69	43.90	21.62	2.88
60	15.50	20.60	21.37	28.59	1.17	0.69	42.52	21.66	2.80
70	15.50	20.60	21.45	28.39	1.17	0.69	40.91	21.68	2.82
80	15.49	20.61	21.53	28.22	1.17	0.69	40.12	21.78	2.76
90	15.48	20.61	21.63	27.91	1.17	0.70	40.01	21.79	2.73
100	15.48	20.61	21.69	27.64	1.17	0.70	39.72	21.77	2.70
110	15.47	20.61	21.58	27.23	1.18	0.70	38.91	21.75	2.74
120	15.47	20.61	21.57	26.92	1.17	0.70	38.68	21.78	2.76
130	15.46	20.62	21.57	26.40	1.17	0.69	38.63	21.79	2.70
140	15.45	20.62	21.53	25.98	1.17	0.70	39.60	21.72	2.70
150	15.43	20.61	21.55	25.58	1.18	0.70	40.22	21.62	2.71
160	15.42	20.63	21.55	25.13	1.18	0.70	41.00	21.63	2.71
170	15.42	20.64	21.61	24.70	1.18	0.70	41.73	21.63	2.75
180	15.41	20.64	21.51	24.26	1.18	0.70	41.02	21.64	2.74
190	15.40	20.64	21.47	23.73	1.18	0.70	40.99	21.64	2.72
200	15.39	20.65	21.48	23.25	1.18	0.70	40.63	21.65	2.66
250	15.33	20.70	21.21	20.84	1.18	0.71	41.24	21.58	2.72
300	15.25	20.78	20.90	18.49	1.19	0.71	42.62	21.52	2.68
350	15.15	20.86	20.08	16.26	1.19	0.71	43.32	21.40	2.75
400	15.03	20.98	19.24	14.24	1.20	0.71	41.39	21.26	2.78
450	14.87	21.14	18.07	12.38	1.21	0.71	38.90	21.10	2.76
500	14.66	21.33	16.80	10.69	1.22	0.70	38.56	21.05	2.74
550	14.39	21.59	15.51	9.15	1.23	0.69	37.34	20.83	2.74
600	14.05	21.91	14.12	7.78	1.23	0.67	35.54	20.68	2.81
650	13.61	22.32	12.86	6.56	1.25	0.64	34.72	20.34	2.66
700	13.08	22.84	11.64	5.53	1.27	0.62	33.53	19.89	2.68
750	12.45	23.43	10.75	4.73	1.30	0.59	32.85	19.26	2.82
800	11.97	23.87	10.06	4.13	1.32	0.56	31.91	18.64	2.77
850	11.36	24.44	9.17	3.46	1.33	0.51	30.98	17.88	2.84
900	10.57	25.20	8.30	2.89	1.36	0.47	29.66	16.87	2.65
950	9.65	26.07	7.55	2.43	1.42	0.44	28.75	15.92	2.99
1000	8.63	27.03	6.90	2.08	1.49	0.41	27.67	14.85	2.86

## Typical Performance Data

TB-966+

**Definitions:**

Input Return Loss = -S11 (dB)

Gain(Power Gain) = S21 (dB)

Reverse Isolation = -S12 (dB)

Output Return Loss = -S22 (dB)

TEST CONDITIONS: Vd = 5.00V, Icc = 54.80mA @ Temperature = +25°C

FREQ	Gain	Isolation	Input Return Loss	Output Return Loss	Stability		IP-3 Output	1dB Comp. Output	Noise Figure
					K	Measure			
(MHz)	(dB)	(dB)	(dB)	(dB)	K	Measure	(dBm)	(dBm)	(dB)
1	13.79	25.68	2.98	4.45	1.16	0.69	--	16.23	--
3	15.32	20.91	9.83	14.51	1.14	0.73	34.16	18.49	--
5	15.28	20.70	13.41	19.10	1.17	0.72	34.44	18.53	--
10	15.16	20.50	16.95	23.45	1.18	0.71	31.87	18.51	3.36
20	15.17	20.46	19.11	26.29	1.18	0.71	32.24	18.52	3.01
30	15.16	20.46	19.47	26.98	1.18	0.71	34.60	18.57	2.93
40	15.16	20.47	19.48	27.18	1.18	0.71	36.76	18.77	2.87
50	15.16	20.47	19.75	27.21	1.19	0.71	39.99	18.79	2.87
60	15.14	20.47	19.71	26.93	1.19	0.71	40.82	18.80	2.79
70	15.14	20.47	19.81	26.74	1.18	0.71	38.76	18.80	2.81
80	15.13	20.47	19.82	26.58	1.19	0.71	36.91	18.90	2.78
90	15.12	20.47	19.86	26.29	1.19	0.71	36.09	18.90	2.72
100	15.12	20.47	19.93	26.01	1.19	0.71	35.60	18.86	2.68
110	15.11	20.48	19.90	25.64	1.19	0.71	34.37	18.85	2.72
120	15.10	20.48	19.80	25.34	1.19	0.71	34.14	18.87	2.70
130	15.09	20.49	19.82	24.89	1.19	0.71	34.35	18.86	2.73
140	15.08	20.50	19.77	24.52	1.19	0.71	35.21	18.78	2.66
150	15.07	20.49	19.78	24.17	1.19	0.72	36.42	18.67	2.67
160	15.06	20.51	19.67	23.76	1.19	0.72	36.81	18.67	2.66
170	15.05	20.51	19.70	23.38	1.19	0.72	37.37	18.66	2.76
180	15.04	20.52	19.65	22.97	1.19	0.72	36.92	18.66	2.73
190	15.03	20.53	19.61	22.50	1.20	0.72	36.03	18.66	2.72
200	15.02	20.54	19.58	22.04	1.19	0.72	35.42	18.68	2.66
250	14.95	20.60	19.34	19.81	1.20	0.72	37.15	18.56	2.68
300	14.87	20.68	19.02	17.63	1.20	0.73	36.00	18.46	2.72
350	14.76	20.77	18.38	15.51	1.21	0.73	36.89	18.32	2.80
400	14.62	20.90	17.68	13.58	1.21	0.73	34.93	18.15	2.77
450	14.45	21.08	16.74	11.81	1.22	0.72	33.30	17.96	2.75
500	14.23	21.29	15.67	10.19	1.23	0.72	32.56	17.88	2.71
550	13.94	21.56	14.59	8.72	1.24	0.70	31.57	17.63	2.71
600	13.58	21.89	13.39	7.40	1.25	0.68	30.02	17.39	2.81
650	13.12	22.32	12.25	6.25	1.26	0.65	29.12	16.93	2.59
700	12.57	22.84	11.18	5.26	1.29	0.62	27.73	16.27	2.63
750	11.93	23.43	10.37	4.52	1.31	0.59	26.88	15.50	2.85
800	11.45	23.87	9.72	3.94	1.33	0.56	25.68	14.75	2.70
850	10.83	24.44	8.91	3.31	1.34	0.51	24.54	13.93	2.80
900	10.03	25.19	8.05	2.78	1.37	0.47	22.59	12.88	2.59
950	9.12	26.03	7.35	2.34	1.41	0.43	21.37	11.92	2.88
1000	8.11	26.97	6.72	2.01	1.46	0.40	20.01	10.80	2.89

## Typical Performance Data

### TB-966+

#### Definitions:

Input Return Loss = -S11 (dB)

Gain(Power Gain) = S21 (dB)

Reverse Isolation = -S12 (dB)

Output Return Loss = -S22 (dB)

TEST CONDITIONS: Vd = 9.00V, Icc = 110.23mA @ Temperature = +25°C

FREQ	Gain	Isolation	Input Return Loss	Output Return Loss	Stability		IP-3 Output	1dB Comp. Output	Noise Figure
					K	Measure			
(MHz)	(dB)	(dB)	(dB)	(dB)	K	Measure	(dBm)	(dBm)	(dB)
1	14.34	25.99	2.91	4.46	1.14	0.69	--	20.90	--
3	15.88	21.08	10.03	15.03	1.12	0.70	42.48	23.18	--
5	15.81	20.83	13.88	19.88	1.15	0.69	43.59	23.39	--
10	15.69	20.72	18.24	24.51	1.16	0.68	44.26	23.30	3.75
20	15.69	20.65	20.99	27.95	1.16	0.68	41.57	23.15	3.29
30	15.68	20.64	21.72	28.94	1.17	0.69	43.35	23.39	3.12
40	15.68	20.65	22.08	29.30	1.17	0.68	44.50	23.60	3.05
50	15.68	20.65	22.18	29.39	1.16	0.68	44.60	23.65	2.99
60	15.67	20.65	22.25	29.11	1.17	0.68	44.59	23.70	2.94
70	15.66	20.66	22.40	28.96	1.16	0.68	43.74	23.73	2.93
80	15.66	20.65	22.45	28.86	1.16	0.68	43.66	23.84	2.85
90	15.65	20.64	22.62	28.57	1.17	0.69	43.41	23.85	2.81
100	15.64	20.65	22.60	28.35	1.17	0.69	42.51	23.85	2.80
110	15.63	20.65	22.68	27.95	1.17	0.68	41.22	23.84	2.82
120	15.63	20.65	22.69	27.67	1.17	0.69	41.70	23.88	2.78
130	15.62	20.66	22.72	27.17	1.17	0.69	41.35	23.89	2.83
140	15.62	20.66	22.81	26.78	1.17	0.69	42.10	23.84	2.75
150	15.60	20.66	22.56	26.42	1.17	0.69	42.44	23.76	2.80
160	15.59	20.66	22.66	25.97	1.17	0.69	43.51	23.78	2.80
170	15.59	20.67	22.65	25.57	1.17	0.69	44.38	23.77	2.88
180	15.58	20.67	22.60	25.13	1.17	0.69	43.89	23.79	2.83
190	15.57	20.68	22.54	24.59	1.17	0.69	43.33	23.79	2.80
200	15.56	20.68	22.55	24.09	1.17	0.69	43.49	23.81	2.75
250	15.51	20.72	22.34	21.62	1.18	0.70	43.60	23.78	2.80
300	15.43	20.79	21.97	19.20	1.18	0.70	46.32	23.75	2.79
350	15.34	20.87	21.05	16.88	1.19	0.71	46.12	23.65	2.83
400	15.22	20.97	20.16	14.79	1.19	0.71	46.19	23.52	2.84
450	15.07	21.13	18.79	12.86	1.20	0.70	43.30	23.37	2.80
500	14.87	21.31	17.34	11.11	1.21	0.70	42.53	23.34	2.81
550	14.62	21.56	15.93	9.51	1.22	0.69	41.51	23.12	2.82
600	14.29	21.88	14.43	8.08	1.23	0.67	39.19	22.97	2.89
650	13.87	22.27	13.08	6.82	1.24	0.64	38.32	22.65	2.78
700	13.34	22.78	11.82	5.74	1.27	0.62	37.14	22.22	2.79
750	12.72	23.37	10.89	4.90	1.29	0.59	36.34	21.64	2.93
800	12.24	23.83	10.16	4.27	1.31	0.57	35.47	21.08	2.83
850	11.63	24.41	9.24	3.58	1.33	0.52	34.60	20.41	2.86
900	10.84	25.17	8.33	2.99	1.36	0.47	33.41	19.51	2.76
950	9.90	26.05	7.59	2.50	1.42	0.44	32.53	18.51	2.99
1000	8.87	27.05	6.94	2.14	1.49	0.42	31.83	17.51	2.93



## Typical Performance Data

### TB-966+

#### Definitions:

Input Return Loss = -S11 (dB)

Gain(Power Gain) = S21 (dB)

Reverse Isolation = -S12 (dB)

Output Return Loss = -S22 (dB)

TEST CONDITIONS: Vd = 7.00V, Icc = 80.93mA @ Temperature = -45°C

FREQ	Gain	Isolation	Input Return Loss	Output Return Loss	Stability		IP-3 Output	1dB Comp. Output	Noise Figure
					K	Measure			
(MHz)	(dB)	(dB)	(dB)	(dB)	K	Measure	(dBm)	(dBm)	(dB)
1	13.91	26.31	2.85	4.25	1.17	0.69	--	18.71	--
3	15.75	21.34	9.82	14.39	1.14	0.73	38.48	21.03	--
5	15.72	20.75	13.56	18.95	1.15	0.69	39.70	21.21	--
10	15.62	20.65	17.85	23.28	1.16	0.69	40.14	21.17	3.05
20	15.62	20.58	20.12	26.24	1.16	0.68	41.69	21.00	2.57
30	15.60	20.58	20.72	26.90	1.16	0.68	43.35	21.24	2.46
40	15.61	20.59	20.85	27.00	1.17	0.69	43.04	21.45	2.37
50	15.60	20.60	20.99	26.90	1.16	0.68	42.50	21.50	2.37
60	15.59	20.59	20.88	26.54	1.17	0.69	42.56	21.54	2.31
70	15.59	20.59	20.93	26.32	1.16	0.68	40.50	21.57	2.33
80	15.59	20.59	21.06	26.14	1.16	0.68	39.41	21.67	2.26
90	15.58	20.58	20.86	25.88	1.16	0.68	39.54	21.69	2.23
100	15.58	20.59	20.84	25.67	1.16	0.68	39.48	21.68	2.19
110	15.57	20.59	20.76	25.38	1.17	0.69	38.51	21.67	2.23
120	15.57	20.59	20.71	25.18	1.17	0.69	38.53	21.71	2.22
130	15.56	20.59	20.70	24.87	1.17	0.69	38.61	21.73	2.24
140	15.56	20.60	20.63	24.66	1.17	0.69	39.23	21.67	2.15
150	15.55	20.59	20.54	24.50	1.17	0.69	39.83	21.58	2.22
160	15.54	20.60	20.58	24.31	1.17	0.69	40.17	21.60	2.22
170	15.54	20.60	20.61	24.15	1.17	0.69	40.39	21.60	2.24
180	15.53	20.60	20.76	23.99	1.17	0.69	40.28	21.61	2.22
190	15.53	20.60	20.69	23.75	1.17	0.69	39.81	21.62	2.22
200	15.52	20.61	20.81	23.51	1.17	0.69	39.87	21.65	2.17
250	15.48	20.63	21.20	21.91	1.17	0.69	40.69	21.59	2.18
300	15.43	20.69	21.54	19.59	1.17	0.69	41.26	21.54	2.20
350	15.34	20.75	21.34	17.09	1.18	0.69	41.70	21.43	2.24
400	15.24	20.85	20.74	14.82	1.18	0.69	40.73	21.28	2.22
450	15.10	20.99	19.38	12.83	1.19	0.69	39.16	21.11	2.21
500	14.92	21.16	17.91	11.08	1.19	0.68	38.28	21.08	2.19
550	14.69	21.39	16.35	9.50	1.20	0.67	37.36	20.89	2.18
600	14.38	21.67	14.77	8.08	1.20	0.65	35.75	20.76	2.28
650	14.00	22.04	13.31	6.82	1.21	0.62	34.90	20.45	2.14
700	13.50	22.51	11.94	5.72	1.23	0.60	33.87	20.02	2.12
750	12.87	23.12	10.84	4.80	1.25	0.57	33.18	19.32	2.30
800	12.34	23.63	10.26	4.23	1.28	0.55	32.37	18.61	2.19
850	11.86	24.07	9.40	3.57	1.27	0.50	31.59	17.90	2.23
900	11.13	24.77	8.43	2.95	1.29	0.45	30.23	16.86	2.04
950	10.24	25.60	7.63	2.43	1.32	0.41	29.28	15.83	2.37
1000	9.24	26.56	6.90	2.04	1.37	0.38	27.99	14.72	2.25

## Typical Performance Data

### TB-966+

#### Definitions:

Input Return Loss = -S11 (dB)

Gain(Power Gain) = S21 (dB)

Reverse Isolation = -S12 (dB)

Output Return Loss = -S22 (dB)

TEST CONDITIONS: Vd = 5.00V, Icc = 52.63mA @ Temperature = -45°C

FREQ	Gain	Isolation	Input Return Loss	Output Return Loss	Stability		IP-3 Output	1dB Comp. Output	Noise Figure
					K	Measure			
(MHz)	(dB)	(dB)	(dB)	(dB)	K	Measure	(dBm)	(dBm)	(dB)
1	13.44	26.02	2.87	4.13	1.18	0.67	--	16.08	--
3	15.39	21.14	9.60	13.88	1.15	0.73	35.45	18.33	--
5	15.39	20.49	13.19	18.15	1.15	0.69	35.64	18.52	--
10	15.27	20.50	17.20	22.41	1.17	0.70	35.89	18.42	2.84
20	15.28	20.46	18.81	24.83	1.17	0.70	33.49	18.22	2.52
30	15.27	20.44	19.32	25.30	1.17	0.70	36.19	18.45	2.37
40	15.27	20.44	19.48	25.35	1.18	0.70	41.68	18.65	2.31
50	15.26	20.46	19.50	25.26	1.17	0.70	43.55	18.67	2.34
60	15.26	20.45	19.41	24.94	1.17	0.70	40.75	18.69	2.26
70	15.25	20.45	19.49	24.75	1.18	0.70	36.81	18.69	2.26
80	15.25	20.45	19.36	24.57	1.17	0.70	35.64	18.78	2.26
90	15.24	20.45	19.39	24.33	1.18	0.70	35.26	18.79	2.20
100	15.24	20.46	19.36	24.13	1.18	0.70	34.76	18.76	2.16
110	15.23	20.46	19.26	23.86	1.18	0.70	33.94	18.74	2.23
120	15.22	20.45	19.21	23.68	1.18	0.70	33.71	18.77	2.21
130	15.22	20.46	19.15	23.39	1.18	0.70	34.07	18.77	2.22
140	15.21	20.47	19.10	23.19	1.18	0.70	34.79	18.69	2.14
150	15.20	20.46	19.04	23.04	1.18	0.70	35.50	18.59	2.21
160	15.19	20.47	19.06	22.84	1.18	0.70	35.92	18.60	2.20
170	15.19	20.48	19.07	22.67	1.18	0.70	36.20	18.59	2.24
180	15.19	20.48	19.09	22.51	1.18	0.70	35.90	18.59	2.19
190	15.18	20.48	19.11	22.28	1.18	0.70	35.40	18.59	2.23
200	15.17	20.49	19.10	22.04	1.18	0.70	35.05	18.61	2.18
250	15.13	20.53	19.36	20.56	1.18	0.71	36.54	18.51	2.18
300	15.07	20.59	19.64	18.47	1.19	0.71	35.59	18.40	2.15
350	14.98	20.66	19.47	16.17	1.19	0.71	36.09	18.25	2.22
400	14.86	20.78	18.93	14.05	1.20	0.71	34.30	18.04	2.23
450	14.71	20.94	17.85	12.16	1.20	0.70	32.95	17.80	2.17
500	14.51	21.12	16.66	10.48	1.21	0.69	32.18	17.72	2.24
550	14.25	21.36	15.35	8.98	1.21	0.68	31.27	17.47	2.11
600	13.93	21.67	14.04	7.64	1.22	0.66	29.90	17.21	2.27
650	13.52	22.05	12.76	6.44	1.23	0.63	29.07	16.75	2.08
700	13.02	22.53	11.48	5.40	1.24	0.60	27.89	15.99	2.03
750	12.37	23.14	10.47	4.54	1.27	0.56	26.92	15.04	2.31
800	11.83	23.65	9.89	4.00	1.29	0.55	25.71	14.23	2.18
850	11.35	24.09	9.13	3.38	1.28	0.49	24.70	13.46	2.21
900	10.61	24.78	8.21	2.80	1.30	0.44	22.65	12.43	2.00
950	9.74	25.59	7.46	2.32	1.32	0.40	21.40	11.42	2.37
1000	8.75	26.53	6.77	1.96	1.37	0.37	20.10	10.32	2.31

## Typical Performance Data

**TB-966+**

**Definitions:**

Input Return Loss = -S11 (dB)

Gain(Power Gain) = S21 (dB)

Reverse Isolation = -S12 (dB)

Output Return Loss = -S22 (dB)

TEST CONDITIONS: Vd = 9.00V, Icc = 108.35mA @ Temperature = -45°C

FREQ	Gain	Isolation	Input Return Loss	Output Return Loss	Stability		IP-3 Output	1dB Comp. Output	Noise Figure
					K	Measure			
(MHz)	(dB)	(dB)	(dB)	(dB)	K	Measure	(dBm)	(dBm)	(dB)
1	14.06	26.50	2.84	4.25	1.17	0.69	--	20.76	--
3	15.92	21.07	9.87	14.61	1.12	0.69	41.20	23.11	--
5	15.87	20.87	13.76	19.39	1.15	0.69	43.78	23.28	--
10	15.77	20.73	18.16	23.89	1.16	0.68	44.47	23.22	3.50
20	15.77	20.67	20.61	27.27	1.16	0.68	43.70	23.04	2.83
30	15.76	20.67	21.43	28.09	1.16	0.68	43.74	23.30	2.60
40	15.76	20.67	21.54	28.24	1.16	0.68	47.09	23.52	2.50
50	15.76	20.67	21.71	28.15	1.16	0.68	46.03	23.57	2.44
60	15.75	20.67	21.62	27.77	1.16	0.68	47.16	23.63	2.38
70	15.74	20.67	21.86	27.54	1.16	0.68	44.10	23.66	2.44
80	15.74	20.67	21.81	27.35	1.16	0.68	43.97	23.77	2.35
90	15.73	20.67	21.79	27.08	1.16	0.68	43.04	23.80	2.33
100	15.73	20.67	21.71	26.85	1.16	0.68	42.92	23.80	2.23
110	15.72	20.67	21.61	26.54	1.16	0.68	42.87	23.80	2.34
120	15.72	20.66	21.63	26.34	1.16	0.68	41.69	23.85	2.25
130	15.72	20.67	21.51	25.98	1.16	0.68	42.47	23.87	2.29
140	15.71	20.67	21.47	25.75	1.16	0.68	42.59	23.84	2.26
150	15.70	20.66	21.45	25.60	1.16	0.68	43.01	23.76	2.22
160	15.69	20.67	21.52	25.38	1.16	0.68	43.93	23.78	2.27
170	15.69	20.66	21.55	25.22	1.16	0.68	44.36	23.79	2.35
180	15.69	20.67	21.64	25.05	1.16	0.68	44.67	23.82	2.28
190	15.69	20.66	21.68	24.80	1.16	0.68	44.35	23.83	2.29
200	15.68	20.67	21.79	24.55	1.17	0.69	42.87	23.86	2.26
250	15.64	20.69	22.27	22.80	1.16	0.69	43.57	23.84	2.23
300	15.59	20.74	22.76	20.30	1.17	0.69	46.38	23.83	2.24
350	15.51	20.80	22.40	17.65	1.17	0.69	46.07	23.73	2.32
400	15.41	20.88	21.70	15.29	1.18	0.69	47.38	23.60	2.28
450	15.28	21.02	20.21	13.24	1.18	0.69	46.09	23.44	2.26
500	15.11	21.18	18.56	11.43	1.19	0.68	44.26	23.44	2.29
550	14.89	21.40	16.85	9.81	1.19	0.67	43.00	23.25	2.26
600	14.59	21.67	15.19	8.36	1.20	0.65	40.50	23.13	2.31
650	14.21	22.03	13.63	7.05	1.21	0.63	39.60	22.86	2.20
700	13.73	22.50	12.19	5.91	1.23	0.60	38.31	22.52	2.21
750	13.10	23.11	11.04	4.96	1.25	0.57	37.60	21.89	2.34
800	12.58	23.61	10.43	4.36	1.28	0.55	36.73	21.25	2.33
850	12.11	24.04	9.53	3.68	1.27	0.50	35.72	20.65	2.31
900	11.38	24.75	8.53	3.04	1.29	0.45	34.56	19.68	2.11
950	10.49	25.60	7.70	2.50	1.33	0.41	33.58	18.65	2.45
1000	9.47	26.57	6.97	2.09	1.37	0.38	32.47	17.55	2.29

## Typical Performance Data

### TB-966+

#### Definitions:

Input Return Loss = -S11 (dB)

Gain(Power Gain) = S21 (dB)

Reverse Isolation = -S12 (dB)

Output Return Loss = -S22 (dB)

TEST CONDITIONS: Vd = 7.00V, Icc = 84.07mA @ Temperature = +85°C

FREQ	Gain	Isolation	Input Return Loss	Output Return Loss	Stability		IP-3 Output	1dB Comp. Output	Noise Figure
					K	Measure			
(MHz)	(dB)	(dB)	(dB)	(dB)			(dBm)	(dBm)	(dB)
1	14.12	25.82	3.00	4.62	1.16	0.70	--	18.49	--
3	15.55	21.19	10.12	15.49	1.15	0.74	39.79	20.84	--
5	15.48	20.61	13.83	20.10	1.15	0.70	40.28	20.97	--
10	15.38	20.58	17.92	24.42	1.17	0.70	40.86	20.92	3.98
20	15.39	20.54	20.29	27.71	1.17	0.70	37.28	20.74	3.57
30	15.38	20.53	20.86	28.67	1.18	0.70	43.03	21.00	3.43
40	15.38	20.54	21.04	29.06	1.17	0.70	45.62	21.20	3.37
50	15.37	20.54	21.46	29.24	1.18	0.70	43.87	21.24	3.31
60	15.36	20.54	21.35	29.05	1.18	0.70	45.85	21.30	3.29
70	15.35	20.54	21.60	28.97	1.18	0.70	42.77	21.32	3.31
80	15.35	20.54	21.77	28.93	1.18	0.70	41.32	21.42	3.21
90	15.33	20.55	21.84	28.67	1.18	0.70	41.27	21.43	3.16
100	15.33	20.55	21.89	28.39	1.18	0.70	40.51	21.42	3.18
110	15.32	20.55	22.01	27.94	1.18	0.70	39.68	21.41	3.19
120	15.31	20.55	22.06	27.54	1.18	0.70	39.18	21.44	3.20
130	15.30	20.56	22.01	26.91	1.18	0.70	39.22	21.45	3.16
140	15.29	20.56	22.10	26.38	1.18	0.70	39.81	21.39	3.13
150	15.28	20.56	22.01	25.83	1.18	0.70	41.26	21.30	3.15
160	15.26	20.58	22.10	25.25	1.18	0.70	41.14	21.31	3.12
170	15.26	20.58	22.00	24.70	1.19	0.71	42.62	21.30	3.22
180	15.25	20.59	21.94	24.15	1.19	0.71	42.71	21.32	3.20
190	15.23	20.60	21.83	23.53	1.19	0.71	42.58	21.32	3.16
200	15.22	20.61	21.73	22.95	1.19	0.71	41.61	21.33	3.15
250	15.15	20.66	21.06	20.29	1.19	0.71	42.61	21.27	3.12
300	15.05	20.76	20.14	18.00	1.20	0.72	46.15	21.22	3.18
350	14.93	20.86	18.98	15.91	1.21	0.72	49.10	21.13	3.17
400	14.80	20.99	18.04	14.05	1.22	0.73	42.06	20.99	3.27
450	14.63	21.17	16.84	12.30	1.22	0.73	39.52	20.85	3.15
500	14.40	21.38	15.67	10.67	1.24	0.72	39.03	20.78	3.23
550	14.12	21.65	14.57	9.15	1.25	0.71	37.41	20.53	3.15
600	13.75	22.00	13.42	7.79	1.26	0.69	35.53	20.34	3.27
650	13.29	22.43	12.32	6.58	1.29	0.67	34.56	19.95	3.16
700	12.74	22.96	11.32	5.56	1.32	0.64	33.38	19.48	3.11
750	12.14	23.53	10.56	4.78	1.34	0.61	32.64	18.90	3.37
800	11.62	24.02	9.84	4.14	1.36	0.58	31.65	18.30	3.29
850	10.96	24.64	9.06	3.49	1.39	0.53	30.73	17.61	3.30
900	10.16	25.40	8.30	2.96	1.42	0.49	29.46	16.73	3.13
950	9.26	26.23	7.65	2.53	1.49	0.46	28.61	15.87	3.41
1000	8.29	27.15	7.07	2.20	1.57	0.43	27.95	14.94	3.37

## Typical Performance Data

### TB-966+

#### Definitions:

Input Return Loss = -S11 (dB)

Gain(Power Gain) = S21 (dB)

Reverse Isolation = -S12 (dB)

Output Return Loss = -S22 (dB)

TEST CONDITIONS: Vd = 5.00V, Icc = 55.62mA @ Temperature = +85°C

FREQ	Gain	Isolation	Input Return Loss	Output Return Loss	Stability		IP-3 Output	1dB Comp. Output	Noise Figure
					K	Measure			
(MHz)	(dB)	(dB)	(dB)	(dB)	K	Measure	(dBm)	(dBm)	(dB)
1	13.71	25.65	3.04	4.60	1.18	0.71	--	15.94	--
3	15.17	20.77	9.98	15.01	1.15	0.73	33.53	18.19	--
5	15.12	20.58	13.42	19.41	1.17	0.72	33.87	18.35	--
10	15.01	20.43	16.90	23.42	1.18	0.72	34.10	18.26	3.79
20	15.02	20.38	18.79	26.06	1.19	0.71	29.07	18.09	3.47
30	15.01	20.38	19.41	26.75	1.19	0.71	30.08	18.32	3.34
40	15.01	20.38	19.43	26.97	1.19	0.71	30.99	18.51	3.31
50	15.01	20.39	19.53	27.10	1.19	0.71	31.64	18.53	3.29
60	14.99	20.38	19.72	26.90	1.19	0.71	32.26	18.56	3.22
70	14.98	20.39	19.82	26.81	1.19	0.71	33.53	18.55	3.22
80	14.98	20.39	19.89	26.72	1.19	0.71	34.69	18.64	3.18
90	14.97	20.39	19.95	26.49	1.19	0.72	35.38	18.64	3.16
100	14.96	20.40	20.03	26.26	1.19	0.72	36.41	18.61	3.12
110	14.95	20.40	20.02	25.87	1.19	0.72	38.56	18.59	3.16
120	14.94	20.41	20.05	25.53	1.20	0.72	39.18	18.61	3.16
130	14.93	20.42	20.06	25.02	1.20	0.72	38.00	18.60	3.18
140	14.92	20.43	20.10	24.58	1.20	0.72	35.93	18.52	3.10
150	14.90	20.42	20.07	24.12	1.20	0.72	35.26	18.41	3.17
160	14.89	20.45	20.02	23.65	1.20	0.72	34.97	18.42	3.11
170	14.88	20.45	20.01	23.17	1.20	0.72	35.01	18.40	3.16
180	14.87	20.46	19.92	22.69	1.20	0.72	35.55	18.40	3.13
190	14.86	20.47	19.84	22.14	1.20	0.72	36.58	18.39	3.11
200	14.84	20.49	19.83	21.63	1.20	0.73	37.15	18.41	3.09
250	14.76	20.56	19.21	19.19	1.21	0.73	35.91	18.30	3.15
300	14.66	20.66	18.37	17.02	1.22	0.74	36.75	18.20	3.15
350	14.53	20.78	17.42	15.05	1.22	0.74	36.95	18.09	3.21
400	14.38	20.93	16.51	13.27	1.23	0.74	35.05	17.94	3.20
450	14.19	21.12	15.57	11.63	1.24	0.74	33.63	17.76	3.14
500	13.95	21.34	14.60	10.09	1.25	0.73	33.49	17.68	3.19
550	13.65	21.63	13.64	8.65	1.26	0.72	32.14	17.41	3.12
600	13.26	21.99	12.65	7.36	1.28	0.70	30.38	17.19	3.27
650	12.79	22.44	11.71	6.22	1.30	0.67	29.40	16.76	3.12
700	12.22	22.98	10.78	5.27	1.33	0.64	28.15	16.17	3.03
750	11.61	23.54	10.10	4.53	1.36	0.61	27.25	15.54	3.31
800	11.07	24.04	9.46	3.92	1.38	0.57	26.02	14.88	3.19
850	10.40	24.65	8.74	3.31	1.40	0.52	24.96	14.11	3.24
900	9.60	25.40	8.02	2.81	1.44	0.48	23.31	13.14	3.09
950	8.71	26.23	7.41	2.41	1.49	0.45	22.13	12.24	3.40
1000	7.76	27.12	6.85	2.11	1.57	0.43	21.56	11.29	3.33

## Typical Performance Data

### TB-966+

#### Definitions:

Input Return Loss = -S11 (dB)

Gain(Power Gain) = S21 (dB)

Reverse Isolation = -S12 (dB)

Output Return Loss = -S22 (dB)

TEST CONDITIONS: Vd = 9.00V, Icc = 111.79mA @ Temperature = +85°C

FREQ	Gain	Isolation	Input Return Loss	Output Return Loss	Stability		IP-3 Output	1dB Comp. Output	Noise Figure
					K	Measure			
(MHz)	(dB)	(dB)	(dB)	(dB)			(dBm)	(dBm)	(dB)
1	14.23	25.98	2.99	4.59	1.16	0.71	--	20.36	--
3	15.73	20.95	10.21	15.50	1.13	0.71	41.28	22.78	--
5	15.65	21.00	13.97	20.33	1.17	0.72	41.97	22.93	--
10	15.54	20.64	18.32	24.56	1.17	0.69	42.58	22.87	4.20
20	15.55	20.59	20.83	27.79	1.17	0.69	41.50	22.72	3.75
30	15.54	20.58	21.65	28.81	1.17	0.69	44.46	22.98	3.54
40	15.54	20.58	21.97	29.23	1.17	0.69	42.78	23.19	3.46
50	15.53	20.58	22.37	29.47	1.17	0.69	44.82	23.23	3.42
60	15.52	20.58	22.51	29.31	1.17	0.69	47.04	23.31	3.38
70	15.51	20.59	22.74	29.30	1.17	0.69	45.03	23.34	3.41
80	15.51	20.58	22.82	29.32	1.17	0.69	43.44	23.45	3.32
90	15.50	20.58	22.91	29.14	1.17	0.69	42.72	23.47	3.28
100	15.49	20.58	23.02	28.95	1.17	0.69	42.30	23.48	3.24
110	15.48	20.58	23.07	28.58	1.17	0.69	41.69	23.47	3.29
120	15.48	20.59	23.13	28.24	1.17	0.69	41.71	23.51	3.29
130	15.47	20.59	23.29	27.65	1.17	0.69	41.48	23.52	3.31
140	15.46	20.60	23.25	27.16	1.18	0.69	41.98	23.49	3.23
150	15.44	20.59	23.27	26.65	1.17	0.69	42.56	23.41	3.25
160	15.43	20.60	23.21	26.08	1.18	0.70	43.43	23.43	3.28
170	15.42	20.61	23.28	25.54	1.18	0.70	44.50	23.43	3.32
180	15.42	20.61	23.22	24.99	1.18	0.70	44.19	23.46	3.29
190	15.40	20.62	23.06	24.36	1.18	0.70	42.92	23.46	3.26
200	15.39	20.63	22.99	23.78	1.18	0.70	43.25	23.48	3.23
250	15.32	20.68	22.20	21.04	1.18	0.70	44.54	23.48	3.29
300	15.23	20.76	21.17	18.68	1.19	0.71	46.19	23.46	3.25
350	15.12	20.85	19.90	16.51	1.20	0.72	45.72	23.38	3.34
400	14.99	20.99	18.76	14.59	1.21	0.72	48.23	23.26	3.31
450	14.83	21.15	17.43	12.78	1.22	0.72	43.14	23.12	3.28
500	14.62	21.35	16.19	11.09	1.23	0.72	42.49	23.07	3.33
550	14.34	21.61	14.98	9.51	1.24	0.70	41.14	22.80	3.27
600	13.99	21.95	13.70	8.09	1.26	0.69	38.82	22.60	3.40
650	13.54	22.38	12.56	6.83	1.28	0.67	37.94	22.18	3.27
700	12.99	22.91	11.47	5.78	1.31	0.64	36.77	21.67	3.24
750	12.40	23.47	10.69	4.96	1.34	0.61	35.92	21.08	3.45
800	11.88	23.97	9.94	4.29	1.36	0.58	35.65	20.48	3.41
850	11.23	24.59	9.13	3.62	1.39	0.53	34.09	19.79	3.45
900	10.43	25.35	8.35	3.06	1.43	0.50	33.04	18.95	3.18
950	9.52	26.22	7.72	2.61	1.50	0.47	32.17	18.07	3.53
1000	8.54	27.16	7.15	2.27	1.60	0.44	31.73	17.15	3.53

## Typical Performance Data

### TB-916+

**Definitions:**

Input Return Loss = -S11 (dB)

Gain(Power Gain) = S21 (dB)

Reverse Isolation = -S12 (dB)

Output Return Loss = -S22 (dB)

TEST CONDITIONS: Vd = 8.50V, Id = 103.65mA @ Temperature = +25°C

FREQ	Gain	Isolation	Input Return Loss	Output Return Loss	Stability		IP-3 Output	1dB Comp. Output	Noise Figure
					K	Measure			
(MHz)	(dB)	(dB)	(dB)	(dB)			(dBm)	(dBm)	(dB)
2	16.14	21.68	8.05	10.98	1.08	0.70	-	21.15	-
3	16.02	20.80	14.65	16.32	1.10	0.69	44.19	22.26	-
4	15.88	20.83	18.57	18.89	1.13	0.69	43.97	22.55	-
5	15.81	20.86	20.83	20.48	1.15	0.70	43.92	22.70	-
6	15.79	20.80	21.92	21.76	1.15	0.69	43.73	22.78	-
7	15.73	20.59	22.47	22.74	1.15	0.68	43.80	22.83	-
8	15.74	20.82	22.77	23.74	1.17	0.69	43.65	22.87	-
9	15.69	20.69	22.77	24.02	1.16	0.69	43.68	22.91	-
10	15.72	20.59	22.71	24.81	1.15	0.68	43.77	22.92	3.75
20	15.73	20.60	23.58	27.20	1.16	0.68	43.77	23.00	3.27
30	15.70	20.61	23.56	27.54	1.16	0.68	43.74	23.15	3.11
40	15.68	20.60	23.71	27.93	1.16	0.68	43.85	23.27	3.09
50	15.69	20.58	23.15	27.46	1.16	0.68	43.73	23.31	3.02
60	15.67	20.60	23.51	27.31	1.16	0.68	43.81	23.27	2.96
70	15.67	20.61	23.58	27.18	1.16	0.68	43.86	23.22	2.98
80	15.66	20.59	23.59	26.95	1.16	0.68	43.79	23.19	2.87
90	15.67	20.60	23.64	26.69	1.16	0.68	43.82	23.22	2.87
100	15.65	20.60	23.75	26.32	1.16	0.68	44.03	23.18	2.81
110	15.64	20.61	23.73	25.92	1.16	0.68	43.98	23.18	2.84
120	15.62	20.61	23.60	25.36	1.17	0.68	44.13	23.14	2.86
130	15.60	20.62	23.59	24.82	1.17	0.68	44.11	23.13	2.80
140	15.58	20.64	23.54	24.18	1.17	0.69	44.09	23.12	2.85
150	15.53	20.68	23.13	23.45	1.17	0.69	44.13	23.07	2.78
160	15.47	20.75	22.69	22.71	1.18	0.70	44.27	23.11	2.84
170	15.36	20.85	21.92	21.96	1.20	0.72	44.11	23.02	2.86
180	15.19	21.01	20.98	21.72	1.22	0.74	43.85	22.94	2.86
190	15.06	21.14	20.32	22.50	1.24	0.76	43.82	22.87	2.89
200	15.08	21.11	20.56	24.52	1.23	0.76	43.97	22.88	2.82
210	15.19	20.99	21.23	25.98	1.22	0.74	44.42	22.97	2.79
220	15.28	20.90	21.82	25.73	1.21	0.73	44.55	23.03	2.80
230	15.33	20.86	22.31	24.59	1.20	0.72	44.54	23.10	2.79
240	15.34	20.84	22.47	23.28	1.20	0.72	44.78	23.15	2.83
250	15.34	20.84	22.64	22.05	1.20	0.72	44.83	23.12	2.80
260	15.32	20.86	22.51	20.90	1.20	0.72	45.68	23.10	2.79
270	15.29	20.88	22.19	19.80	1.20	0.72	46.21	23.12	2.78
280	15.25	20.93	21.84	18.73	1.20	0.72	46.47	23.08	2.83
290	15.19	20.98	21.36	17.71	1.21	0.73	46.18	23.10	2.86
300	15.11	21.05	20.60	16.57	1.21	0.73	45.72	23.08	2.85
350	14.23	21.93	16.00	11.71	1.32	0.78	42.56	22.22	2.86
400	11.37	24.77	11.13	7.91	1.82	0.90	37.15	19.43	2.98
450	12.66	23.48	11.26	9.34	1.55	0.87	36.80	20.80	2.74



## Typical Performance Data

### TB-916+

**Definitions:**

Input Return Loss = -S11 (dB)

Gain(Power Gain) = S21 (dB)

Reverse Isolation = -S12 (dB)

Output Return Loss = -S22 (dB)

TEST CONDITIONS: Vd = 5.00V, Id = 53.93mA @ Temperature = +25°C

FREQ	Gain	Isolation	Input Return Loss	Output Return Loss	Stability		IP-3 Output	1dB Comp. Output	Noise Figure
					K	Measure			
(MHz)	(dB)	(dB)	(dB)	(dB)	K	Measure	(dBm)	(dBm)	(dB)
2	15.63	21.49	8.24	11.04	1.09	0.73	-	16.73	-
3	15.54	20.87	14.65	16.90	1.13	0.73	35.07	17.90	-
4	15.39	20.67	18.18	19.65	1.15	0.72	38.42	18.20	-
5	15.33	20.40	19.73	21.15	1.15	0.70	40.73	18.30	-
6	15.31	20.48	20.34	22.29	1.16	0.71	42.51	18.47	-
7	15.25	20.53	20.51	23.07	1.17	0.71	44.07	18.42	-
8	15.26	20.21	20.59	23.67	1.15	0.69	44.63	18.48	-
9	15.21	20.46	20.57	23.90	1.18	0.71	45.13	18.59	-
10	15.25	20.37	21.47	24.40	1.17	0.70	45.33	18.61	3.43
20	15.26	20.45	20.87	25.69	1.18	0.70	43.66	18.63	3.06
30	15.23	20.40	20.81	25.69	1.18	0.70	42.25	18.73	2.95
40	15.20	20.40	21.06	25.89	1.18	0.70	41.01	18.83	2.93
50	15.21	20.38	20.65	25.48	1.18	0.70	40.75	18.83	2.88
60	15.19	20.42	20.68	25.28	1.18	0.70	39.88	18.75	2.79
70	15.19	20.42	20.78	25.12	1.18	0.70	39.06	18.68	2.80
80	15.18	20.40	20.68	24.90	1.18	0.70	38.62	18.64	2.82
90	15.19	20.43	20.77	24.66	1.18	0.70	38.30	18.66	2.73
100	15.16	20.42	20.87	24.32	1.18	0.70	38.58	18.59	2.75
110	15.16	20.42	20.75	23.96	1.18	0.70	38.39	18.55	2.74
120	15.14	20.44	20.70	23.48	1.18	0.70	38.39	18.48	2.76
130	15.12	20.46	20.64	23.01	1.19	0.71	38.64	18.42	2.77
140	15.09	20.48	20.53	22.48	1.19	0.71	38.61	18.37	2.71
150	15.05	20.52	20.27	21.86	1.19	0.72	38.49	18.32	2.71
160	14.98	20.58	19.92	21.26	1.20	0.72	38.46	18.37	2.74
170	14.87	20.69	19.39	20.69	1.22	0.74	38.43	18.28	2.69
180	14.70	20.85	18.68	20.61	1.24	0.76	38.88	18.19	2.75
190	14.56	20.99	18.19	21.52	1.26	0.78	39.47	18.13	2.73
200	14.59	20.96	18.37	23.42	1.26	0.78	39.45	18.13	2.73
210	14.70	20.84	18.89	24.41	1.24	0.77	39.12	18.19	2.69
220	14.79	20.76	19.33	23.84	1.23	0.76	38.94	18.23	2.64
230	14.83	20.71	19.64	22.71	1.22	0.75	38.39	18.31	2.71
240	14.85	20.70	19.74	21.52	1.22	0.74	38.37	18.36	2.71
250	14.84	20.70	19.77	20.44	1.22	0.74	37.79	18.31	2.70
260	14.82	20.72	19.69	19.43	1.22	0.74	38.10	18.28	2.70
270	14.79	20.75	19.46	18.46	1.22	0.74	38.13	18.30	2.70
280	14.74	20.80	19.19	17.52	1.23	0.74	37.73	18.26	2.73
290	14.68	20.86	18.85	16.61	1.23	0.75	37.30	18.27	2.71
300	14.60	20.94	18.32	15.59	1.24	0.75	36.74	18.25	2.77
350	13.69	21.84	14.74	11.19	1.34	0.80	34.60	17.39	2.84
400	10.84	24.68	10.50	7.79	1.87	0.91	30.47	14.77	2.89
450	12.18	23.34	10.75	9.59	1.59	0.90	29.74	16.20	2.63



## Typical Performance Data

### TB-916+

**Definitions:**

Input Return Loss = -S11 (dB)

Gain(Power Gain) = S21 (dB)

Reverse Isolation = -S12 (dB)

Output Return Loss = -S22 (dB)

TEST CONDITIONS: Vd = 9.00V, Id = 110.76mA @ Temperature = +25°C

FREQ	Gain	Isolation	Input Return Loss	Output Return Loss	Stability		IP-3 Output	1dB Comp. Output	Noise Figure
					K	Measure			
(MHz)	(dB)	(dB)	(dB)	(dB)	K	Measure	(dBm)	(dBm)	(dB)
2	16.17	21.72	8.02	10.92	1.07	0.70	-	21.67	-
3	16.04	21.01	14.65	16.28	1.11	0.70	44.98	22.76	-
4	15.90	20.90	18.59	18.71	1.14	0.70	44.79	23.03	-
5	15.83	20.81	20.95	20.50	1.15	0.69	44.63	23.11	-
6	15.82	20.79	21.97	21.76	1.15	0.69	44.69	23.27	-
7	15.75	20.71	22.52	22.81	1.15	0.69	44.57	23.30	-
8	15.76	20.60	22.95	23.60	1.15	0.68	44.42	23.36	-
9	15.72	20.60	23.03	24.11	1.15	0.68	44.55	23.39	-
10	15.73	20.62	24.50	24.75	1.16	0.68	44.51	23.40	3.78
20	15.76	20.63	23.20	27.24	1.16	0.68	44.54	23.45	3.37
30	15.73	20.61	23.58	27.63	1.16	0.68	44.61	23.59	3.19
40	15.70	20.60	23.88	28.01	1.16	0.68	44.58	23.72	3.12
50	15.71	20.61	23.62	27.58	1.16	0.68	44.45	23.77	3.04
60	15.70	20.60	23.82	27.43	1.16	0.68	44.51	23.72	2.98
70	15.70	20.62	23.74	27.29	1.16	0.68	44.65	23.68	2.99
80	15.69	20.61	23.91	27.07	1.16	0.68	44.63	23.64	2.94
90	15.69	20.62	23.89	26.82	1.16	0.68	44.75	23.68	2.85
100	15.67	20.61	23.97	26.45	1.16	0.68	44.70	23.65	2.89
110	15.66	20.61	23.99	26.06	1.16	0.68	44.82	23.64	2.93
120	15.65	20.62	23.98	25.49	1.16	0.68	44.72	23.61	2.89
130	15.63	20.63	23.81	24.96	1.17	0.68	44.90	23.60	2.85
140	15.60	20.66	23.69	24.31	1.17	0.69	44.84	23.60	2.82
150	15.56	20.69	23.39	23.58	1.17	0.69	44.86	23.55	2.83
160	15.49	20.75	22.83	22.83	1.18	0.70	44.94	23.59	2.90
170	15.39	20.85	22.06	22.09	1.19	0.71	44.90	23.50	2.90
180	15.22	21.02	21.10	21.83	1.22	0.74	44.69	23.42	2.92
190	15.09	21.15	20.47	22.62	1.24	0.76	44.53	23.35	2.86
200	15.11	21.11	20.74	24.66	1.23	0.76	44.69	23.36	2.87
210	15.22	21.00	21.36	26.14	1.22	0.74	45.04	23.45	2.85
220	15.31	20.91	22.02	25.90	1.21	0.73	45.27	23.52	2.84
230	15.36	20.86	22.53	24.76	1.20	0.72	45.30	23.59	2.86
240	15.37	20.85	22.71	23.43	1.20	0.72	45.42	23.64	2.84
250	15.37	20.84	22.81	22.20	1.19	0.72	45.62	23.61	2.82
260	15.35	20.86	22.72	21.03	1.20	0.72	46.54	23.59	2.82
270	15.32	20.89	22.42	19.92	1.20	0.72	47.04	23.61	2.79
280	15.27	20.93	22.03	18.84	1.20	0.72	47.15	23.57	2.82
290	15.21	20.98	21.50	17.81	1.21	0.72	46.96	23.59	2.86
300	15.14	21.06	20.77	16.66	1.21	0.73	46.74	23.57	2.93
350	14.25	21.94	16.06	11.76	1.31	0.78	42.85	22.70	2.93
400	11.40	24.78	11.18	7.93	1.82	0.90	37.82	19.87	3.00
450	12.70	23.48	11.31	9.33	1.55	0.87	37.55	21.25	2.82

## Typical Performance Data

### TB-916+

#### Definitions:

Input Return Loss = -S11 (dB)

Gain(Power Gain) = S21 (dB)

Reverse Isolation = -S12 (dB)

Output Return Loss = -S22 (dB)

TEST CONDITIONS: Vd = 8.50V, Id = 104.14mA @ Temperature = -45°C

FREQ	Gain	Isolation	Input Return Loss	Output Return Loss	Stability		IP-3 Output	1dB Comp. Output	Noise Figure
					K	Measure			
(MHz)	(dB)	(dB)	(dB)	(dB)			(dBm)	(dBm)	(dB)
2	16.29	21.69	7.90	11.11	1.07	0.70	-	21.17	-
3	16.13	20.99	14.57	16.68	1.11	0.69	45.93	22.23	-
4	15.97	20.92	18.49	19.12	1.13	0.69	45.66	22.52	-
5	15.90	20.90	20.70	20.80	1.15	0.69	45.58	22.67	-
6	15.88	20.76	21.70	21.77	1.14	0.68	45.62	22.82	-
7	15.82	20.75	22.32	23.08	1.15	0.68	45.43	22.80	-
8	15.83	20.74	22.62	23.98	1.15	0.68	45.25	22.84	-
9	15.78	20.74	22.76	24.28	1.16	0.68	45.15	22.95	-
10	15.82	20.72	23.38	24.80	1.16	0.68	45.26	22.96	3.61
20	15.83	20.63	23.10	26.85	1.15	0.67	45.34	22.96	2.92
30	15.80	20.63	23.26	26.93	1.15	0.67	45.32	23.10	2.70
40	15.78	20.63	23.04	27.09	1.16	0.67	45.41	23.24	2.61
50	15.78	20.63	22.95	26.48	1.16	0.67	45.23	23.28	2.54
60	15.77	20.63	22.90	26.14	1.16	0.67	45.22	23.25	2.40
70	15.78	20.63	22.76	25.86	1.16	0.67	45.22	23.21	2.44
80	15.76	20.62	22.74	25.54	1.16	0.67	45.21	23.19	2.39
90	15.77	20.64	22.57	25.26	1.16	0.67	45.08	23.24	2.37
100	15.75	20.63	22.62	24.89	1.16	0.67	45.26	23.21	2.37
110	15.74	20.63	22.52	24.57	1.16	0.67	45.28	23.21	2.33
120	15.73	20.63	22.28	24.12	1.16	0.67	45.22	23.19	2.34
130	15.72	20.64	22.23	23.77	1.16	0.68	45.22	23.18	2.36
140	15.70	20.65	22.16	23.40	1.16	0.68	45.37	23.19	2.31
150	15.67	20.67	21.88	22.94	1.16	0.68	45.38	23.16	2.32
160	15.63	20.71	21.62	22.50	1.17	0.69	45.37	23.22	2.36
170	15.56	20.77	21.19	21.95	1.18	0.70	45.34	23.16	2.30
180	15.42	20.91	20.40	21.55	1.19	0.72	44.85	23.10	2.33
190	15.21	21.12	19.41	21.69	1.22	0.75	44.55	22.97	2.36
200	15.07	21.24	19.01	23.59	1.24	0.77	44.39	22.87	2.31
210	15.18	21.13	19.53	27.03	1.23	0.76	44.77	22.95	2.30
220	15.34	20.98	20.45	28.56	1.21	0.74	45.18	23.07	2.26
230	15.43	20.88	21.19	27.29	1.19	0.72	45.36	23.20	2.32
240	15.47	20.84	21.76	25.45	1.19	0.71	45.53	23.28	2.31
250	15.49	20.81	22.11	23.84	1.18	0.71	45.93	23.26	2.27
260	15.49	20.81	22.28	22.41	1.18	0.71	46.78	23.26	2.31
270	15.47	20.83	22.28	21.10	1.18	0.71	47.20	23.29	2.29
280	15.45	20.85	22.14	19.86	1.19	0.71	47.33	23.28	2.32
290	15.41	20.89	21.90	18.70	1.19	0.71	47.01	23.32	2.32
300	15.35	20.94	21.38	17.44	1.19	0.71	46.77	23.32	2.33
350	14.71	21.58	17.09	12.27	1.26	0.74	43.41	22.71	2.35
400	11.95	24.32	11.37	7.51	1.66	0.85	38.61	20.06	2.49
450	12.02	24.25	10.38	7.93	1.65	0.87	35.11	20.16	2.18

## Typical Performance Data

### TB-916+

**Definitions:**

Input Return Loss = -S11 (dB)

Gain(Power Gain) = S21 (dB)

Reverse Isolation = -S12 (dB)

Output Return Loss = -S22 (dB)

TEST CONDITIONS: Vd = 5.00V, Id = 53.31mA @ Temperature = -45°C

FREQ	Gain	Isolation	Input Return Loss	Output Return Loss	Stability		IP-3 Output	1dB Comp. Output	Noise Figure
					K	Measure			
(MHz)	(dB)	(dB)	(dB)	(dB)	K	Measure	(dBm)	(dBm)	(dB)
2	15.85	21.32	8.06	11.35	1.07	0.71	-	16.53	-
3	15.70	20.75	14.63	17.51	1.12	0.71	41.06	17.89	-
4	15.55	20.53	18.20	20.06	1.14	0.70	37.20	18.18	-
5	15.47	20.56	19.80	21.53	1.15	0.70	36.40	18.28	-
6	15.45	20.38	20.32	22.36	1.15	0.69	36.07	18.44	-
7	15.39	20.57	20.53	23.04	1.17	0.70	35.84	18.38	-
8	15.39	20.49	20.65	23.61	1.16	0.70	35.92	18.44	-
9	15.35	20.42	20.65	23.65	1.16	0.69	35.68	18.57	-
10	15.39	20.47	20.13	23.95	1.16	0.69	35.53	18.58	2.96
20	15.40	20.42	20.49	24.70	1.16	0.69	35.39	18.64	2.55
30	15.37	20.41	20.78	24.51	1.17	0.69	35.36	18.74	2.45
40	15.35	20.39	20.88	24.51	1.17	0.69	35.23	18.84	2.37
50	15.35	20.40	20.32	24.02	1.17	0.69	35.14	18.85	2.36
60	15.33	20.40	20.42	23.73	1.17	0.69	35.07	18.79	2.32
70	15.34	20.41	20.51	23.49	1.17	0.69	35.01	18.71	2.29
80	15.33	20.42	20.33	23.23	1.17	0.69	34.91	18.69	2.20
90	15.33	20.42	20.27	22.99	1.17	0.69	34.86	18.72	2.24
100	15.31	20.42	20.17	22.68	1.17	0.69	34.89	18.65	2.21
110	15.31	20.42	20.09	22.42	1.17	0.69	34.90	18.62	2.20
120	15.29	20.43	19.96	22.04	1.17	0.69	34.91	18.55	2.23
130	15.28	20.44	19.90	21.76	1.17	0.69	34.88	18.49	2.24
140	15.26	20.46	19.75	21.46	1.17	0.69	34.89	18.44	2.20
150	15.23	20.49	19.59	21.10	1.18	0.70	34.94	18.41	2.19
160	15.19	20.53	19.35	20.76	1.18	0.70	34.92	18.47	2.21
170	15.11	20.60	18.99	20.36	1.19	0.71	34.83	18.41	2.17
180	14.97	20.73	18.42	20.16	1.21	0.73	34.68	18.34	2.24
190	14.75	20.95	17.61	20.56	1.24	0.77	34.59	18.21	2.22
200	14.62	21.08	17.30	22.68	1.26	0.79	34.57	18.12	2.22
210	14.73	20.97	17.76	25.75	1.25	0.78	34.85	18.17	2.16
220	14.88	20.81	18.46	26.16	1.22	0.76	34.93	18.25	2.16
230	14.98	20.72	19.07	24.69	1.21	0.74	34.95	18.37	2.20
240	15.02	20.67	19.40	23.12	1.20	0.73	35.03	18.45	2.16
250	15.04	20.65	19.62	21.80	1.20	0.73	34.90	18.41	2.20
260	15.04	20.66	19.75	20.62	1.20	0.73	35.09	18.39	2.17
270	15.02	20.67	19.70	19.52	1.20	0.73	35.20	18.41	2.17
280	14.99	20.70	19.61	18.46	1.20	0.73	35.14	18.39	2.18
290	14.95	20.74	19.39	17.47	1.21	0.73	34.92	18.42	2.25
300	14.89	20.80	19.03	16.36	1.21	0.73	34.70	18.42	2.29
350	14.23	21.46	15.72	11.68	1.28	0.76	32.99	17.75	2.24
400	11.45	24.22	10.78	7.35	1.70	0.85	28.42	15.23	2.32
450	11.58	24.11	9.98	8.13	1.69	0.89	30.69	15.60	2.13

## Typical Performance Data

### TB-916+

**Definitions:**

Input Return Loss = -S11 (dB)

Gain(Power Gain) = S21 (dB)

Reverse Isolation = -S12 (dB)

Output Return Loss = -S22 (dB)

TEST CONDITIONS: Vd = 9.00V, Id = 111.00mA @ Temperature = -45°C

FREQ	Gain	Isolation	Input Return Loss	Output Return Loss	Stability		IP-3 Output	1dB Comp. Output	Noise Figure
					K	Measure			
(MHz)	(dB)	(dB)	(dB)	(dB)	K	Measure	(dBm)	(dBm)	(dB)
2	16.32	21.59	7.92	11.09	1.06	0.69	-	21.67	-
3	16.15	20.88	14.51	16.45	1.10	0.68	47.34	22.74	-
4	16.00	20.92	18.52	19.03	1.13	0.69	46.87	23.00	-
5	15.93	20.58	20.76	20.69	1.12	0.67	46.59	23.16	-
6	15.91	20.60	21.64	21.86	1.13	0.67	46.56	23.24	-
7	15.85	20.49	22.54	22.87	1.13	0.66	46.47	23.28	-
8	15.85	20.57	22.60	23.95	1.14	0.67	46.48	23.34	-
9	15.81	20.69	22.84	24.28	1.15	0.68	46.34	23.38	-
10	15.85	20.65	23.44	24.94	1.15	0.67	46.50	23.38	3.74
20	15.85	20.67	23.12	27.08	1.15	0.67	46.35	23.43	3.04
30	15.83	20.66	23.22	27.14	1.15	0.67	46.32	23.57	2.79
40	15.80	20.65	23.57	27.30	1.16	0.67	46.47	23.71	2.68
50	15.81	20.64	22.97	26.68	1.15	0.67	46.23	23.76	2.57
60	15.80	20.64	23.04	26.34	1.16	0.67	46.40	23.72	2.53
70	15.80	20.66	22.91	26.06	1.16	0.67	46.39	23.68	2.44
80	15.79	20.63	22.92	25.75	1.16	0.67	46.30	23.67	2.48
90	15.80	20.65	22.90	25.46	1.16	0.67	46.33	23.71	2.38
100	15.78	20.64	22.74	25.08	1.16	0.67	46.25	23.69	2.37
110	15.77	20.64	22.74	24.74	1.16	0.67	46.19	23.70	2.35
120	15.76	20.64	22.48	24.28	1.16	0.67	46.26	23.67	2.38
130	15.75	20.65	22.42	23.93	1.16	0.67	46.27	23.67	2.39
140	15.73	20.66	22.22	23.54	1.16	0.68	46.28	23.69	2.38
150	15.70	20.69	22.06	23.09	1.16	0.68	46.29	23.66	2.34
160	15.66	20.72	21.82	22.64	1.17	0.69	46.43	23.71	2.39
170	15.59	20.79	21.33	22.07	1.18	0.70	46.25	23.66	2.34
180	15.44	20.92	20.56	21.65	1.19	0.72	45.93	23.60	2.37
190	15.23	21.14	19.52	21.75	1.22	0.75	45.51	23.47	2.36
200	15.10	21.26	19.12	23.62	1.24	0.77	45.38	23.36	2.35
210	15.21	21.15	19.68	27.05	1.23	0.76	45.62	23.45	2.32
220	15.37	20.99	20.59	28.68	1.21	0.74	45.95	23.57	2.33
230	15.46	20.90	21.38	27.45	1.19	0.72	46.27	23.70	2.36
240	15.50	20.85	21.91	25.60	1.19	0.71	46.19	23.78	2.32
250	15.52	20.83	22.27	23.97	1.18	0.71	46.80	23.77	2.33
260	15.52	20.82	22.50	22.53	1.18	0.71	47.59	23.76	2.34
270	15.50	20.84	22.47	21.19	1.18	0.71	47.98	23.79	2.33
280	15.47	20.87	22.35	19.94	1.18	0.71	47.89	23.78	2.33
290	15.43	20.90	22.10	18.78	1.19	0.71	47.74	23.82	2.32
300	15.38	20.95	21.55	17.50	1.19	0.71	47.44	23.83	2.37
350	14.74	21.59	17.18	12.30	1.25	0.74	44.16	23.21	2.38
400	11.99	24.32	11.42	7.52	1.66	0.84	39.07	20.52	2.42
450	12.05	24.26	10.41	7.92	1.65	0.87	36.05	20.63	2.18



## Typical Performance Data

### TB-916+

**Definitions:**

Input Return Loss = -S11 (dB)

Gain(Power Gain) = S21 (dB)

Reverse Isolation = -S12 (dB)

Output Return Loss = -S22 (dB)

TEST CONDITIONS: Vd = 8.50V, Id = 103.09mA @ Temperature = +85°C

FREQ	Gain	Isolation	Input Return Loss	Output Return Loss	Stability		IP-3 Output	1dB Comp. Output	Noise Figure
					K	Measure			
(MHz)	(dB)	(dB)	(dB)	(dB)	K	Measure	(dBm)	(dBm)	(dB)
2	15.93	21.76	8.18	10.87	1.09	0.72	-	20.71	-
3	15.84	21.08	14.66	16.33	1.13	0.72	43.07	21.85	-
4	15.71	20.70	18.59	18.88	1.13	0.70	42.84	22.02	-
5	15.64	20.78	20.78	20.53	1.16	0.70	42.66	22.18	-
6	15.63	20.62	21.78	21.85	1.15	0.69	42.57	22.25	-
7	15.57	20.59	22.28	22.71	1.16	0.69	42.57	22.29	-
8	15.58	20.53	22.66	23.70	1.16	0.68	42.47	22.34	-
9	15.53	20.57	22.75	23.94	1.16	0.69	42.45	22.38	-
10	15.57	20.56	22.31	24.50	1.16	0.69	42.46	22.38	4.26
20	15.56	20.53	22.89	26.80	1.16	0.68	42.55	22.41	3.76
30	15.54	20.53	23.25	27.16	1.17	0.68	42.56	22.57	3.59
40	15.51	20.51	23.75	27.62	1.17	0.68	42.66	22.70	3.49
50	15.52	20.51	23.38	27.30	1.17	0.68	42.63	22.73	3.48
60	15.50	20.53	23.39	27.29	1.17	0.69	42.68	22.69	3.45
70	15.50	20.52	23.67	27.30	1.17	0.68	42.75	22.65	3.44
80	15.49	20.51	23.85	27.21	1.17	0.69	42.76	22.62	3.36
90	15.50	20.53	24.01	27.06	1.17	0.69	42.79	22.66	3.35
100	15.47	20.53	24.21	26.73	1.17	0.69	42.97	22.63	3.35
110	15.46	20.53	24.25	26.31	1.17	0.69	42.97	22.63	3.33
120	15.44	20.55	24.24	25.69	1.17	0.69	43.15	22.59	3.33
130	15.42	20.56	24.26	25.07	1.18	0.69	43.11	22.60	3.31
140	15.38	20.59	23.99	24.30	1.18	0.70	43.15	22.59	3.30
150	15.32	20.64	23.61	23.46	1.19	0.70	43.20	22.53	3.30
160	15.23	20.73	22.97	22.66	1.20	0.72	43.27	22.55	3.33
170	15.10	20.86	22.13	22.06	1.22	0.73	43.19	22.43	3.34
180	14.96	20.98	21.39	22.29	1.24	0.75	43.05	22.38	3.34
190	14.94	21.01	21.33	23.46	1.24	0.76	43.08	22.39	3.28
200	15.01	20.94	21.88	24.75	1.23	0.75	43.41	22.44	3.27
210	15.08	20.85	22.47	24.91	1.22	0.74	43.65	22.52	3.26
220	15.13	20.81	22.90	24.13	1.21	0.73	43.68	22.56	3.26
230	15.15	20.79	23.13	23.04	1.21	0.73	43.95	22.60	3.32
240	15.14	20.79	23.05	21.88	1.21	0.73	43.93	22.63	3.31
250	15.12	20.81	22.90	20.79	1.21	0.73	44.02	22.60	3.28
260	15.09	20.84	22.54	19.74	1.21	0.73	44.64	22.58	3.28
270	15.04	20.88	22.01	18.71	1.22	0.73	45.28	22.58	3.29
280	14.98	20.94	21.40	17.71	1.22	0.74	45.34	22.53	3.31
290	14.89	21.02	20.72	16.74	1.23	0.74	44.98	22.52	3.38
300	14.79	21.12	19.81	15.66	1.24	0.75	44.50	22.47	3.35
350	13.61	22.31	14.89	11.14	1.40	0.82	41.08	21.27	3.35
400	11.26	24.62	11.09	8.58	1.85	0.93	35.06	18.83	3.45
450	12.96	22.94	11.82	10.59	1.49	0.88	37.23	20.63	3.31



## Typical Performance Data

### TB-916+

**Definitions:**

Input Return Loss = -S11 (dB)

Gain(Power Gain) = S21 (dB)

Reverse Isolation = -S12 (dB)

Output Return Loss = -S22 (dB)

TEST CONDITIONS: Vd = 5.00V, Id = 53.80mA @ Temperature = +85°C

FREQ	Gain	Isolation	Input Return Loss	Output Return Loss	Stability		IP-3 Output	1dB Comp. Output	Noise Figure
					K	Measure			
(MHz)	(dB)	(dB)	(dB)	(dB)	K	Measure	(dBm)	(dBm)	(dB)
2	15.42	21.30	8.37	10.98	1.09	0.73	-	16.38	-
3	15.35	20.77	14.71	16.99	1.14	0.74	31.65	17.54	-
4	15.22	20.48	18.00	19.61	1.15	0.72	33.34	17.76	-
5	15.16	20.56	19.56	21.22	1.17	0.72	34.01	17.92	-
6	15.15	20.38	19.98	22.19	1.17	0.71	34.54	18.00	-
7	15.08	20.45	20.22	22.96	1.18	0.72	34.85	18.04	-
8	15.09	20.29	20.36	23.49	1.17	0.70	34.59	18.09	-
9	15.04	20.46	20.34	23.79	1.19	0.72	35.16	18.13	-
10	15.08	20.33	19.77	24.09	1.18	0.71	35.18	18.14	3.83
20	15.09	20.33	20.42	25.28	1.18	0.70	36.08	18.22	3.56
30	15.05	20.30	20.47	25.33	1.18	0.70	36.07	18.33	3.43
40	15.03	20.32	20.57	25.56	1.18	0.71	36.84	18.42	3.38
50	15.03	20.30	20.35	25.25	1.18	0.70	36.91	18.42	3.34
60	15.01	20.32	20.53	25.19	1.19	0.71	37.81	18.35	3.27
70	15.02	20.32	20.75	25.15	1.19	0.71	39.05	18.28	3.31
80	15.00	20.32	20.84	25.04	1.19	0.71	39.83	18.24	3.21
90	15.01	20.34	20.88	24.89	1.19	0.71	40.79	18.26	3.21
100	14.98	20.33	21.03	24.60	1.19	0.71	40.21	18.19	3.20
110	14.97	20.34	21.00	24.22	1.19	0.71	40.82	18.16	3.20
120	14.95	20.35	20.94	23.70	1.19	0.71	41.09	18.08	3.20
130	14.93	20.38	20.83	23.18	1.19	0.71	40.41	18.04	3.17
140	14.89	20.41	20.80	22.56	1.20	0.72	40.81	17.99	3.12
150	14.83	20.47	20.44	21.89	1.21	0.73	41.41	17.92	3.12
160	14.74	20.56	20.03	21.27	1.22	0.74	40.97	17.94	3.19
170	14.61	20.69	19.43	20.87	1.24	0.76	39.89	17.83	3.17
180	14.46	20.82	18.90	21.25	1.26	0.78	38.38	17.76	3.21
190	14.43	20.86	18.87	22.42	1.26	0.78	38.08	17.76	3.20
200	14.50	20.79	19.25	23.43	1.25	0.77	38.75	17.80	3.20
210	14.58	20.70	19.63	23.27	1.24	0.76	39.55	17.85	3.18
220	14.62	20.66	19.91	22.39	1.23	0.76	39.77	17.87	3.14
230	14.65	20.64	20.05	21.35	1.23	0.75	40.63	17.92	3.20
240	14.64	20.64	19.96	20.30	1.23	0.75	40.74	17.95	3.16
250	14.61	20.67	19.84	19.32	1.23	0.75	39.96	17.90	3.20
260	14.58	20.70	19.56	18.38	1.23	0.75	39.24	17.87	3.18
270	14.52	20.75	19.17	17.47	1.24	0.75	38.61	17.86	3.17
280	14.46	20.82	18.78	16.58	1.25	0.76	38.49	17.81	3.14
290	14.37	20.90	18.26	15.71	1.25	0.76	37.93	17.80	3.20
300	14.26	21.01	17.61	14.74	1.27	0.77	37.61	17.76	3.25
350	13.06	22.21	13.73	10.68	1.43	0.83	37.00	16.63	3.25
400	10.73	24.54	10.42	8.53	1.90	0.94	31.94	14.41	3.31
450	12.48	22.80	11.25	10.96	1.53	0.91	29.35	16.11	3.12

## Typical Performance Data

### TB-916+

**Definitions:**

Input Return Loss = -S11 (dB)

Gain(Power Gain) = S21 (dB)

Reverse Isolation = -S12 (dB)

Output Return Loss = -S22 (dB)

TEST CONDITIONS: Vd = 9.00V, Id = 109.89mA @ Temperature = +85°C

FREQ	Gain	Isolation	Input Return Loss	Output Return Loss	Stability		IP-3 Output	1dB Comp. Output	Noise Figure
					K	Measure			
(MHz)	(dB)	(dB)	(dB)	(dB)	K	Measure	(dBm)	(dBm)	(dB)
2	15.95	21.56	8.14	10.88	1.08	0.71	-	21.23	-
3	15.87	20.98	14.69	16.34	1.12	0.71	43.27	22.35	-
4	15.73	20.67	18.73	18.83	1.13	0.69	43.09	22.51	-
5	15.67	20.65	20.92	20.57	1.15	0.69	42.90	22.57	-
6	15.65	20.44	21.79	21.77	1.14	0.68	43.00	22.81	-
7	15.59	20.64	22.45	22.78	1.16	0.69	42.82	22.77	-
8	15.60	20.73	22.81	23.55	1.17	0.70	42.80	22.83	-
9	15.55	20.57	22.99	24.02	1.16	0.69	42.75	22.86	-
10	15.57	20.52	22.42	24.51	1.16	0.68	42.80	22.86	4.35
20	15.58	20.51	23.73	26.78	1.16	0.68	42.89	22.86	3.82
30	15.56	20.53	23.74	27.15	1.16	0.68	42.95	23.02	3.63
40	15.53	20.53	23.83	27.60	1.17	0.68	43.05	23.15	3.57
50	15.54	20.52	23.61	27.29	1.17	0.68	43.02	23.19	3.54
60	15.52	20.53	23.81	27.28	1.17	0.68	43.04	23.15	3.44
70	15.53	20.54	24.02	27.32	1.17	0.68	43.12	23.11	3.46
80	15.51	20.52	24.04	27.22	1.17	0.68	43.15	23.08	3.39
90	15.52	20.54	24.33	27.09	1.17	0.68	43.11	23.12	3.38
100	15.49	20.53	24.43	26.78	1.17	0.69	43.27	23.10	3.40
110	15.48	20.54	24.55	26.35	1.17	0.69	43.30	23.10	3.37
120	15.46	20.55	24.49	25.73	1.17	0.69	43.39	23.07	3.43
130	15.44	20.56	24.40	25.13	1.17	0.69	43.48	23.08	3.35
140	15.40	20.59	24.25	24.36	1.18	0.70	43.57	23.07	3.34
150	15.34	20.65	23.76	23.53	1.19	0.70	43.45	23.01	3.32
160	15.26	20.73	23.18	22.73	1.20	0.72	43.57	23.03	3.35
170	15.12	20.87	22.27	22.13	1.21	0.73	43.46	22.91	3.35
180	14.98	20.99	21.55	22.38	1.23	0.75	43.22	22.86	3.39
190	14.96	21.02	21.53	23.57	1.24	0.76	43.30	22.87	3.37
200	15.03	20.94	22.10	24.88	1.23	0.75	43.50	22.93	3.30
210	15.10	20.86	22.68	25.03	1.22	0.74	43.83	23.00	3.31
220	15.15	20.81	23.09	24.24	1.21	0.73	43.83	23.05	3.32
230	15.17	20.79	23.32	23.14	1.21	0.73	44.04	23.09	3.37
240	15.16	20.79	23.30	21.97	1.21	0.73	44.00	23.12	3.34
250	15.14	20.81	23.11	20.87	1.21	0.73	44.14	23.10	3.31
260	15.11	20.84	22.77	19.81	1.21	0.73	44.88	23.07	3.30
270	15.06	20.88	22.20	18.78	1.21	0.73	45.10	23.07	3.29
280	15.00	20.95	21.59	17.78	1.22	0.74	45.29	23.02	3.31
290	14.91	21.02	20.86	16.80	1.23	0.74	44.85	23.01	3.40
300	14.81	21.13	19.90	15.71	1.24	0.75	44.46	22.96	3.40
350	13.62	22.32	14.93	11.17	1.40	0.82	41.09	21.73	3.42
400	11.29	24.63	11.14	8.60	1.85	0.93	36.49	19.26	3.53
450	12.99	22.93	11.87	10.58	1.49	0.88	38.31	21.10	3.27



## Typical Performance Curves

TB-966+

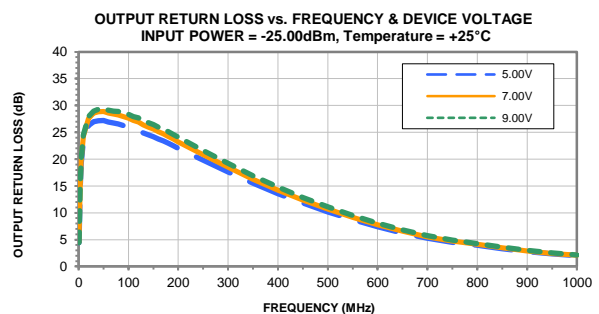
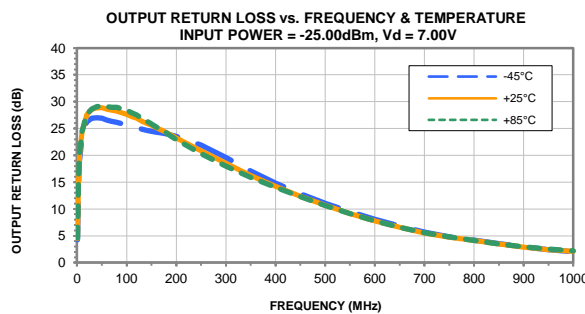
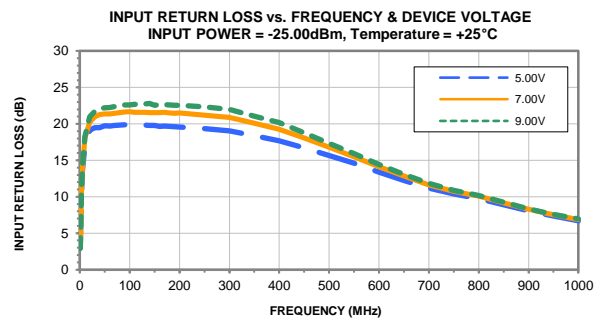
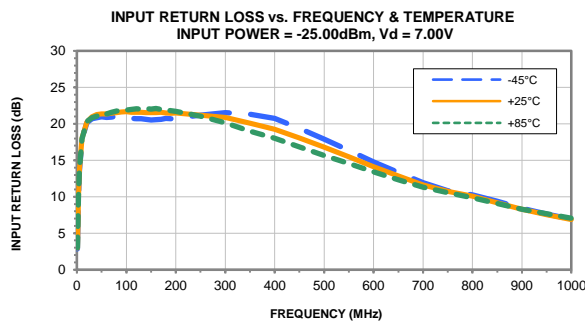
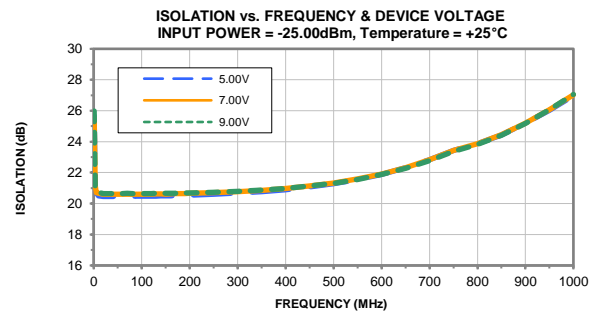
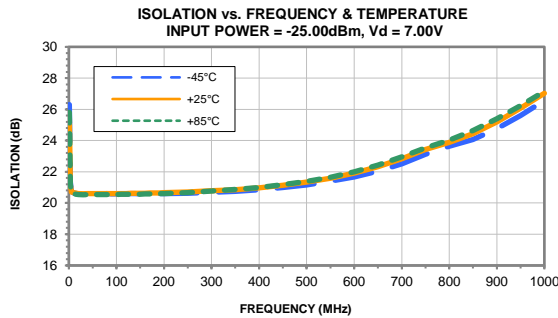
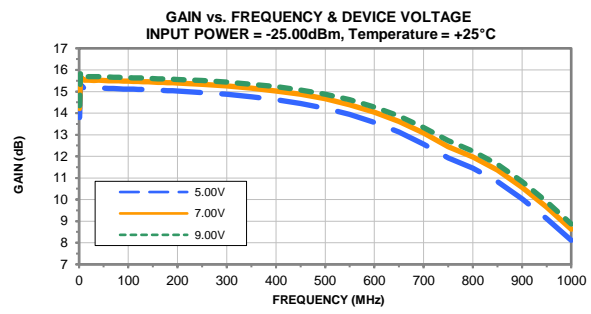
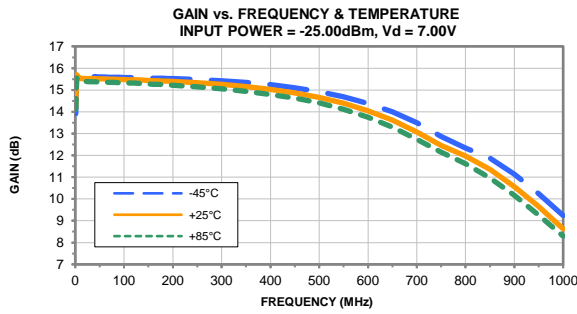



## Typical Performance Curves

TB-966+

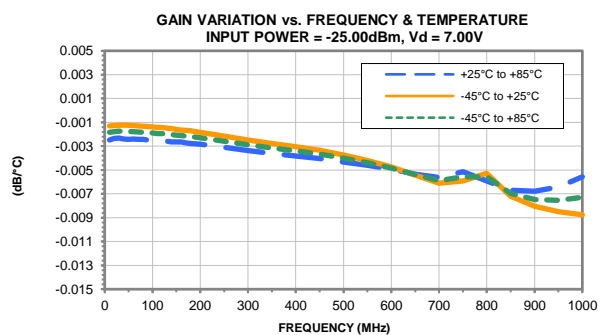
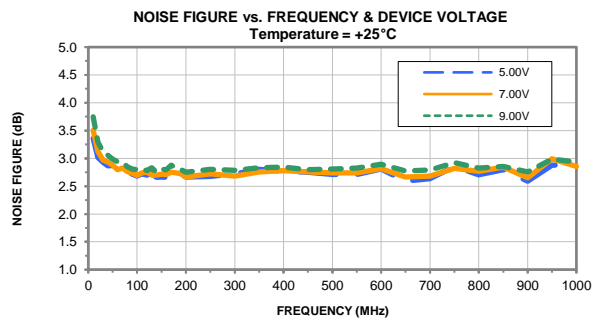
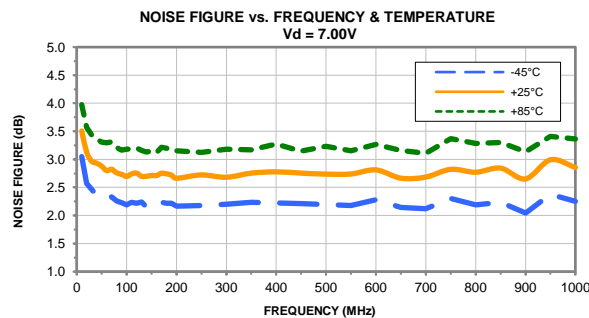
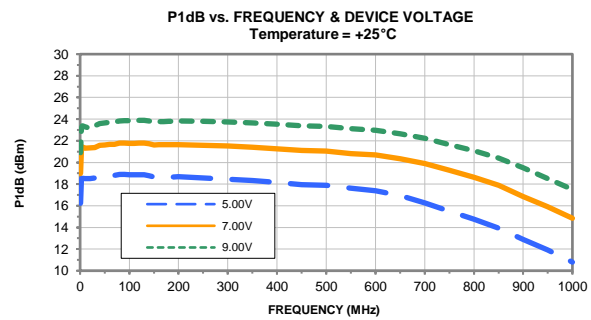
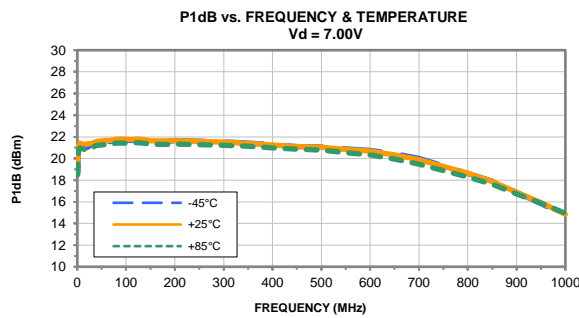
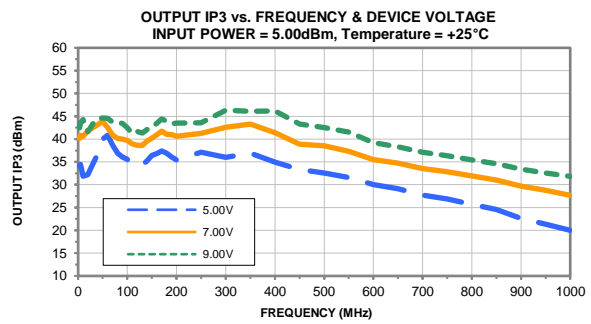
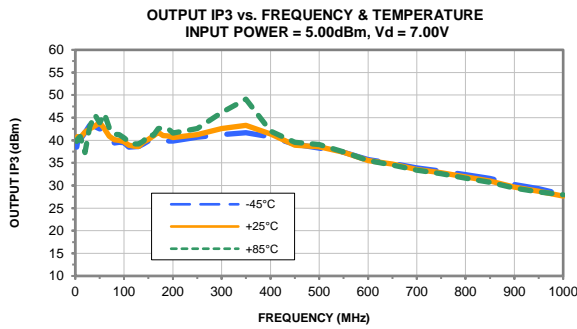

## Typical Performance Curves

TB-916+

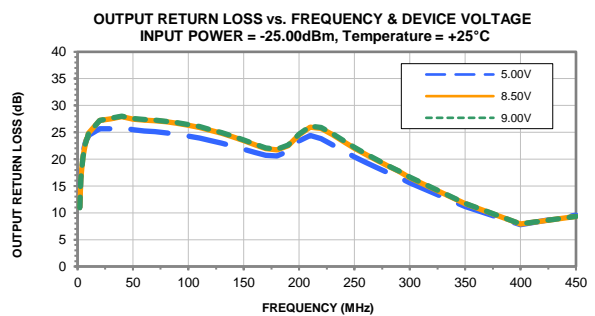
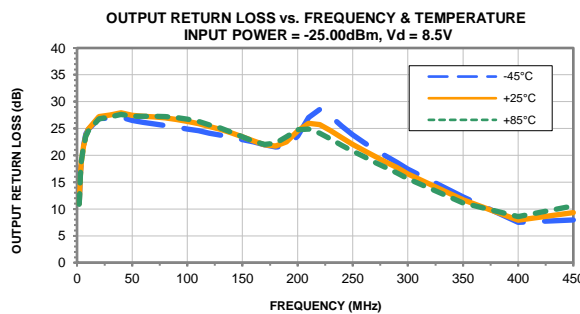
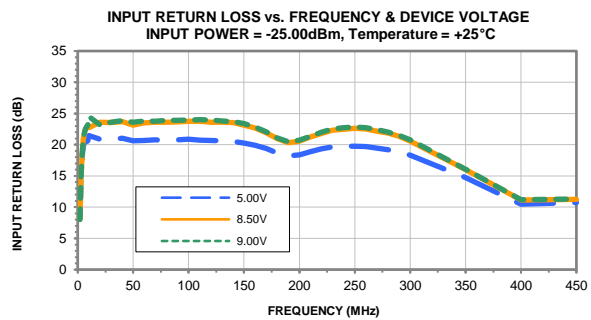
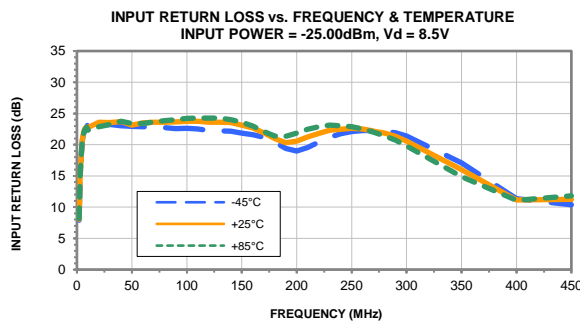
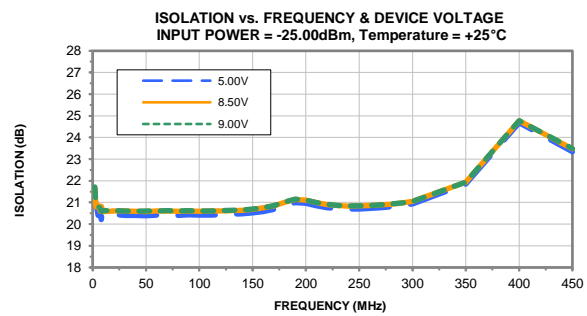
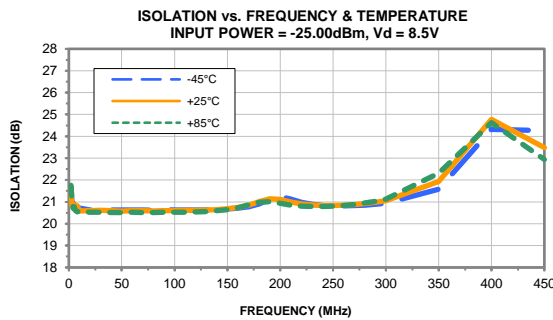
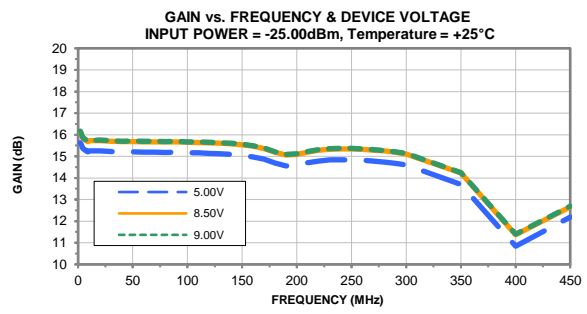
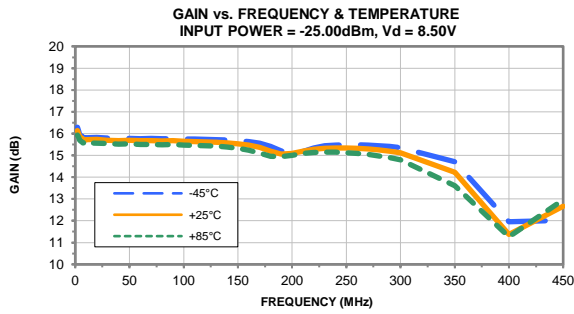

## Typical Performance Curves

TB-916+

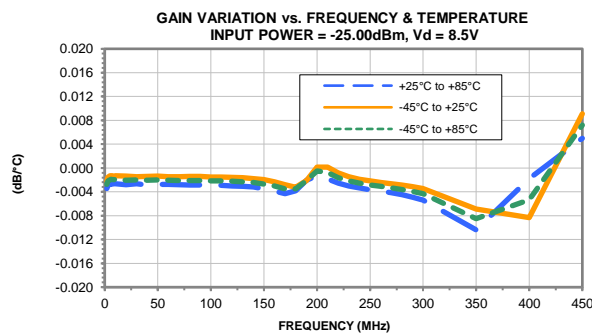
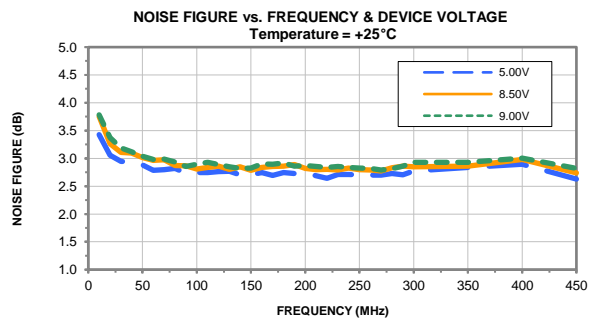
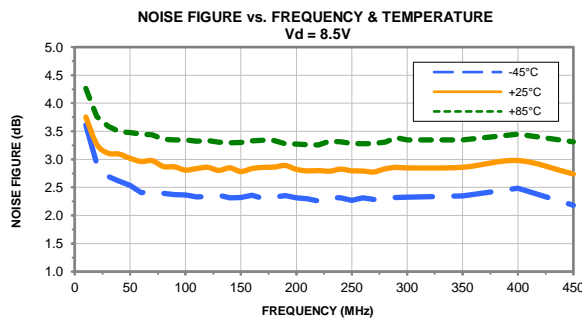
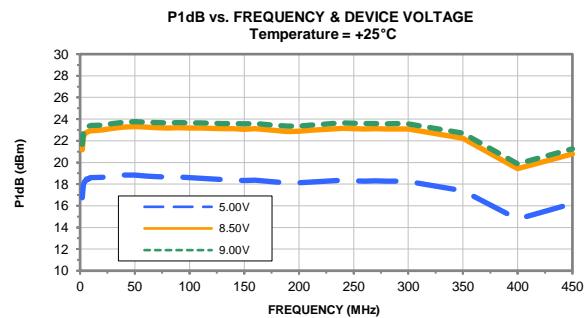
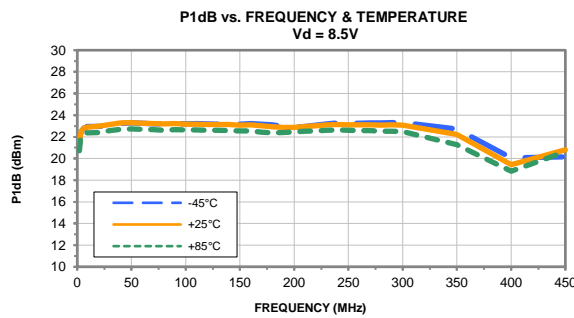
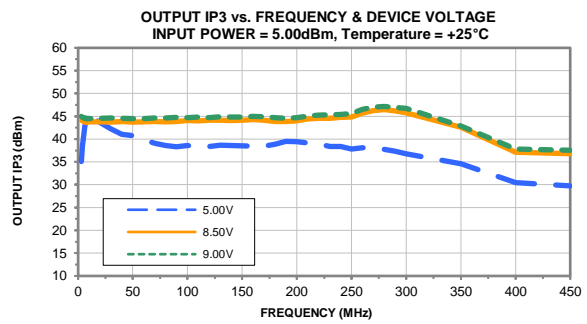
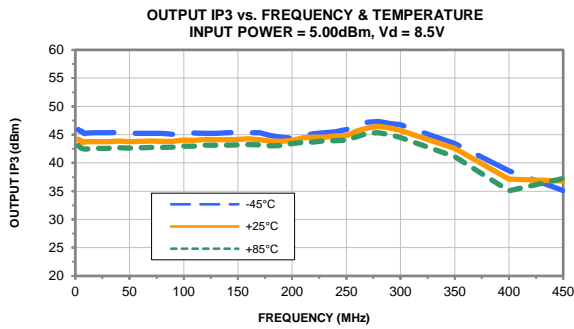

### Outline Dimensions

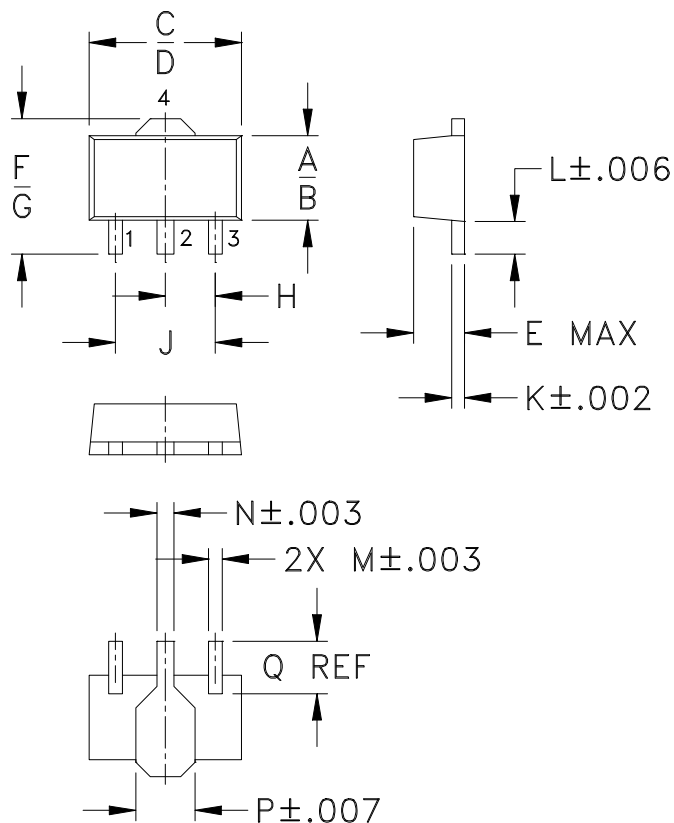

### PCB Land Pattern

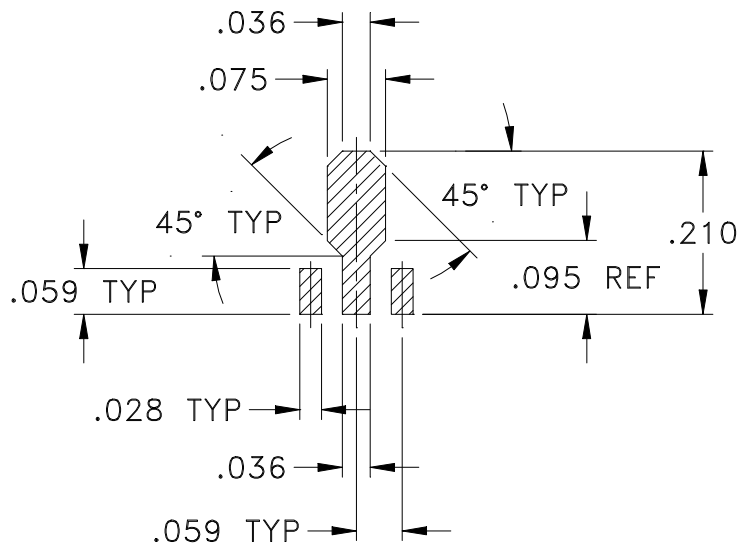

Suggested Layout,  
Tolerance to be within  $\pm .002$

CASE #	A	B	C	D	E	F	G	H	J	K	L	M
DF782	.102 (2.59)	.090 (2.29)	.181 (4.60)	.173 (4.39)	.063 (1.60)	.167 (4.24)	.155 (3.94)	.059 (1.50)	.118 (3.00)	.015 (0.38)	.041 (1.04)	.016 (0.41)

CASE #	N	P	Q	WT. GRAM
DF782	.019 (0.48)	.065 (1.65)	.062 (1.57)	.2

Dimensions are in inches (mm). Tolerances: 2 Pl.  $\pm .01$ ; 3Pl.  $\pm .005$

#### Notes:

- Case material: Plastic.
- Termination finish:  
 For RoHS Case Styles: Tin-Silver alloy plate over Nickel barrier or Matte-Tin.  
 All models, (+) suffix. See model Data sheet.  
 For RoHS-5 Case Styles: Tin-Lead plate. All models, no (+) suffix.



INTERNET <http://www.minicircuits.com>

P.O. Box 350166, Brooklyn, New York 11235-0003 (718) 934-4500 Fax (718) 332-4661

Distribution Centers NORTH AMERICA 800-654-7949 • 417-335-5935 • Fax 417-335-5945 • EUROPE 44-1252-832600 • Fax 44-1252-837010

Mini-Circuits ISO 9001 & ISO 14001 Certified

# Tape & Reel Packaging TR-F55

## DEVICE ORIENTATION IN T&R

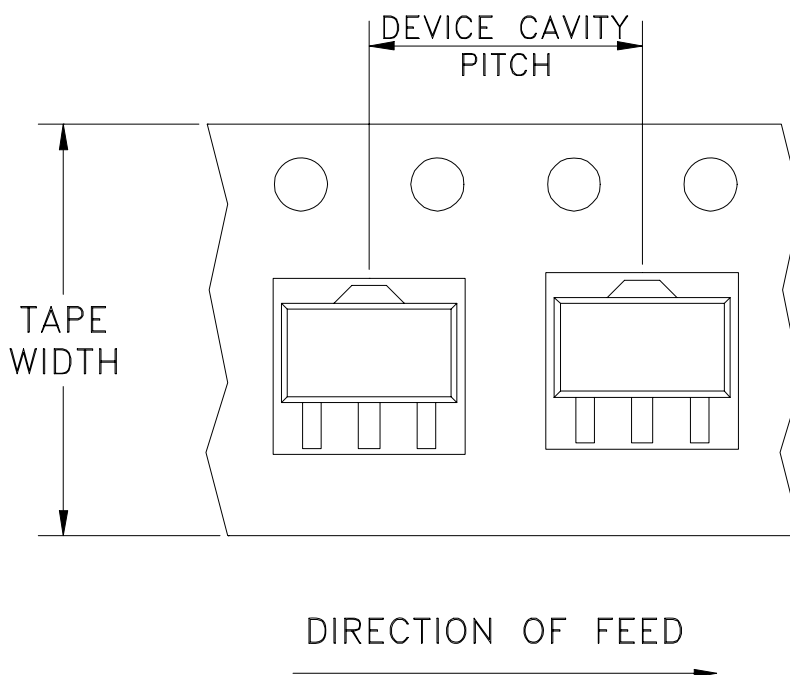

Tape Width, mm	Device Cavity Pitch, mm	Reel Size, inches	Devices per Reel	
12	8	7	Small quantity standard (see note)	20
				50
				100
				200
				500
			Standard	1000

Note: Please consult individual model data sheet to determine device per reel availability.

Mini-Circuits carrier tape materials provide protection from ESD (Electro-Static Discharge) during handling and transportation. Tapes are static dissipative and comply with industry standards EIA-481/EIA-541.

Go to: [www.minicircuits.com/pages/pdfs/tape.pdf](http://www.minicircuits.com/pages/pdfs/tape.pdf)



INTERNET <http://www.minicircuits.com>

P.O. Box 350166, Brooklyn, New York 11235-0003 (718) 934-4500 Fax (718) 332-4661

Distribution Centers NORTH AMERICA 800-654-7949 • 417-335-5935 • Fax 417-335-5945 • EUROPE 44-1252-832600 • Fax 44-1252-837010

Mini-Circuits ISO 9001 & ISO 14001 Certified

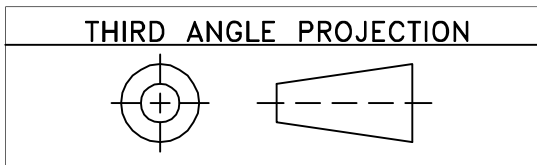

REVISIONS					
REV OR	ECN No.	DESCRIPTION	DATE	DR	AUTH
	M163283	NEW RELEASE	08/11/17	CA	RS

**SUGGESTED MOUNTING CONFIGURATION FOR DF782 CASE STYLE, "04AM03" PIN CONNECTION**

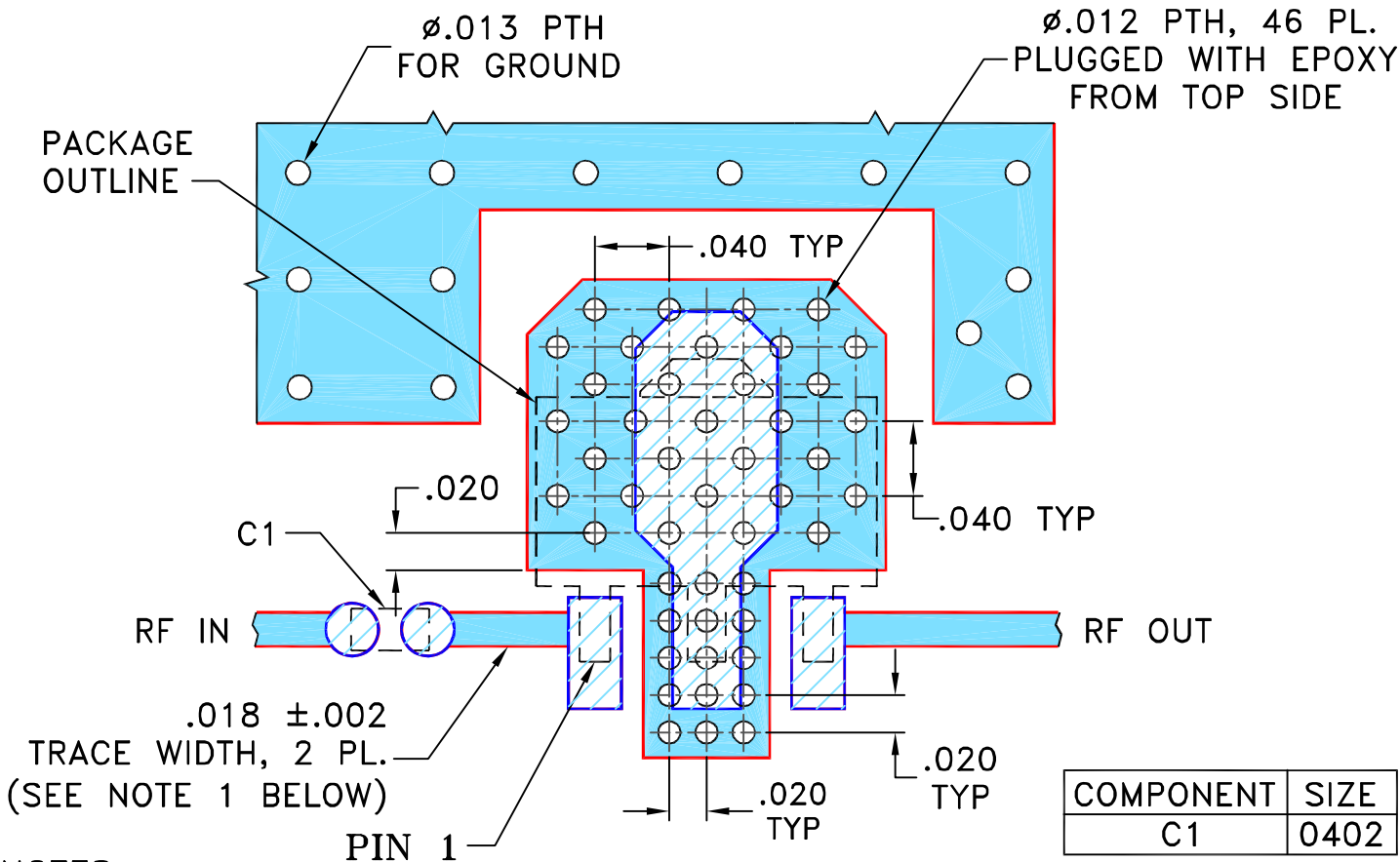

**NOTES:**

1. TRACE WIDTH PARAMETERS ARE SHOWN FOR FR4, GRADE IT-180TC WITH DIELECTRIC THICKNESS .020" ± .002"; COPPER: 1/2 OZ. EACH SIDE. FOR OTHER MATERIALS TRACE WIDTH MAY NEED TO BE MODIFIED.
2. CHIP COMPONENT FOOT PRINT SHOWN FOR REFERENCE. FOR COMPONENT VALUE REFER TO TB-966+.
3. BOTTOM SIDE OF THE PCB IS CONTINUOUS GROUND PLANE.



DENOTES PCB COPPER LAYOUT WITH SMOBC (SOLDER MASK OVER BARE COPPER)



DENOTES COPPER LAND PATTERN FREE OF SOLDER MASK

UNLESS OTHERWISE SPECIFIED	INITIALS	DATE
DIMENSIONS ARE IN INCHES	DRAWN CA	08/08/17
TOLERANCES ON:	CHECKED GF	08/11/17
2 PL DECIMALS ±	APPROVED RS	08/11/17
3 PL DECIMALS ± .005		
ANGLES ±		
FRACTIONS ±		



**Mini-Circuits®**

13 Neptune Avenue  
Brooklyn NY 11235

**PL, 04AM03, DF782, TB-966+**

Mini-Circuits®  
THIS DOCUMENT AND ITS CONTENTS ARE THE PROPERTY OF MINI-CIRCUITS. EXCEPT FOR USE EXPRESSLY GRANTED, IN WRITING, TO ITS VENDORS, VENDEE AND THE UNITED STATES GOVERNMENT, MINI-CIRCUITS RESERVES ALL PROPRIETARY DESIGN, USE, MANUFACTURING AND REPRODUCTION RIGHTS THERE TO. THESE CONTENTS SHALL NOT BE USED, DUPLICATED OR DISCLOSED TO ANY OUTSIDE PARTY, IN WHOLE OR IN PART, WITHOUT WRITTEN PERMISSION OF MINI-CIRCUITS.

SIZE A	CODE IDENT 15542	DRAWING NO: 98-PL-521	REV: OR
FILE: 98PL521	SCALE: 10:1	SHEET: 1 OF 1	

# Evaluation Board and Circuit

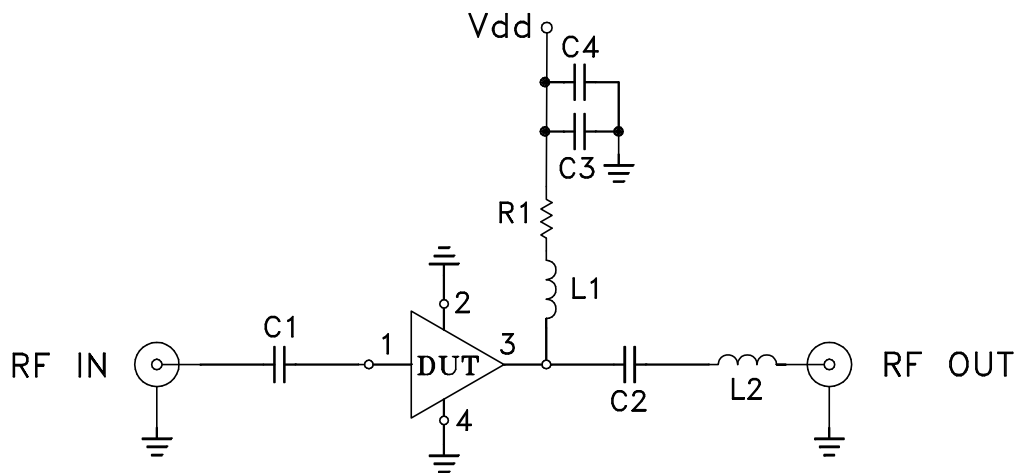
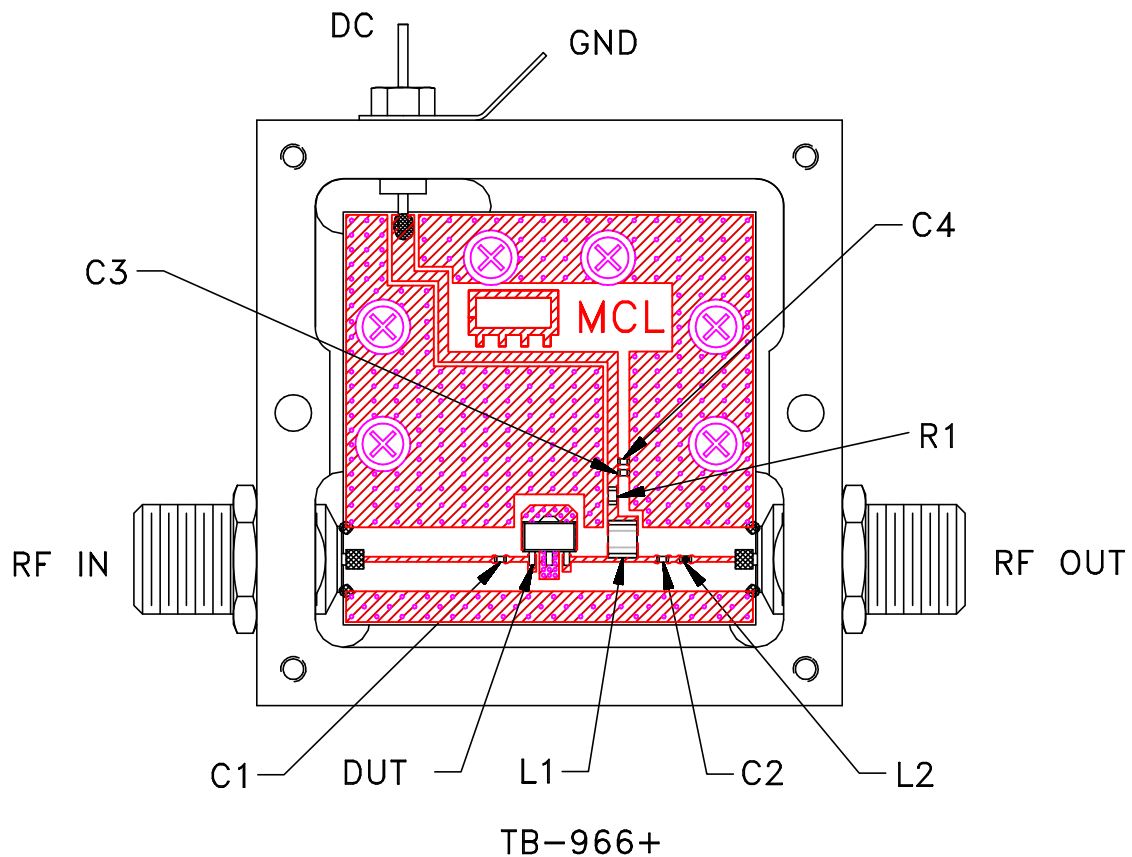

COMPONENT	VALUE	SIZE
DUT	PGA-32-75+	SOT89
C1,C4	0.1 $\mu$ F	0402
C2	0.01 $\mu$ F	
C3	0.001 $\mu$ F	
L1	6800nH	1210
L2	12 nH	0402
R1	4.99 Ohm	0603

Schematic Diagram

## Notes:

1. 75 Ohm F-type Female connectors.
2. PCB Material: FR4 or equivalent,  
Dielectric Constant=4.6, Thickness=.020 inch.

 **Mini-Circuits®**

All Mini-Circuits products are manufactured under exacting quality assurance and control standards, and are capable of meeting published specifications after being subjected to any or all of the following physical and environmental test.

Specification	Test/Inspection Condition	Reference/Spec
Operating Temperature	-40° to 85°C or -45° to 85°C Ambient Environment	Individual Model Data Sheet
Storage Temperature	-55° to 100° C or -65° to 150° Ambient Environment	Individual Model Data Sheet
Thermal Shock	-55° to 100°C, 100 cycles	MIL-STD-202, Method 107, Condition A-3, except +100°C
Mechanical Shock	1.5Kg, 0.5 ms, 5 shock pulses, Y1 direction only	MIL-STD-883, Method 2002, Condition B, except Y1 direction only
Vibration (Variable Frequency)	50g peak	MIL-STD-883, Method 2007, Condition B
Autoclave	15 psig, 100% RH, 121°C, 96 hours	JESD22-A102, Condition C
HAST	130°C, 85% RH, 96 hours	JESD22-A110
Solderability	10X Magnification	J-STD-002, Para 4.2.5, Test S, 95% Coverage
Solder Reflow Heat	Sn-Pb Eutetic Process: 240°C peak Pb-Free Process: 260°C peak	J-STD-020, Table 4-1, 4-2 and 5-2; Figure 5-1
Moisture Sensitivity: Level 1	Bake at 125°C for 24 hours Soak at 85°C/85% RH for 168 hours, Reflow 3 cycles at 260°C peak	J-STD-020
Marking Resistance to Solvents	Isopropyl alcohol + mineral spirits at 25°C; terpene defluxer at 25°C; distilled water + proylene glycol monomethyl ether +	MIL-STD-202, Method 215





All Mini-Circuits products are manufactured under exacting quality assurance and control standards, and are capable of meeting published specifications after being subjected to any or all of the following physical and environmental test.

<b>Specification</b>	<b>Test/Inspection Condition</b>	<b>Reference/Spec</b>
	monoethanolamine at 63°C to 70°C	