



CERAMIC BALUN

RF Transformer

NCS3-72+

Mini-Circuits

50Ω 250 to 760 MHz 1:3 Ratio

FEATURES

- Wideband, 250 to 760 MHz
- Low phase unbalance 8 deg. and amplitude unbalance, 0.3 dB typ.
- Miniature size 0805, 0.079"x0.049"x0.033"
- Good matching VSWR, 1.5:1 typ.
- LTCC construction
- Low cost
- Aqueous washable

APPLICATIONS

- VHF/UHF
- Signal process
- Instrumentation



Generic photo used for illustration purposes only

CASE STYLE: GE0805C-9

+RoHS Compliant

The +Suffix identifies RoHS Compliance. See our web site for RoHS Compliance methodologies and qualifications

ELECTRICAL SPECIFICATIONS AT 25°C

Parameter	Frequency (MHz)	Min.	Typ.	Max.	Units
Impedance Ratio (Secondary/Primary)			3		
Frequency Range		250		760	MHz
Insertion Loss ¹	250 - 760	—	0.9	1.3	dB
Amplitude Unbalance	250 - 760	—	0.3	1.0	dB
Phase Unbalance ²	250 - 760	—	5	10	Degree

1. Reference Demo Board TB-626+

2. Relative to 180°

MAXIMUM RATINGS

Parameter	Ratings
Operating Temperature	-55°C to 100°C
Storage Temperature	-55°C to 100°C
RF Power ³	2W at 25°C

3. Passband rating, derate linearly to 1W at 100°C ambient.

Permanent damage may occur if any of these limits are exceeded.

CONFIGURATION J

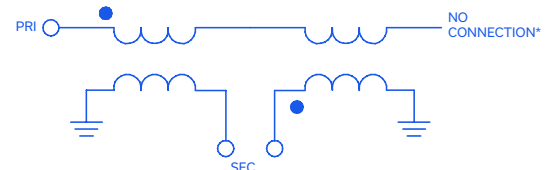

*Internal open circuit

Mini-Circuits

www.minicircuits.com P.O. Box 350166, Brooklyn, NY 11235-0003 (718) 934-4500 sales@minicircuits.com

REV. B
ECO-010420
NCS3-72+
MCL NY
211112

PAGE 1 OF 3



PAD CONNECTIONS

PRIMARY DOT (Unbalanced Port)	2
PRIMARY (GND)	1,3
SECONDARY DOT (Balanced)	4
SECONDARY (Balanced)	6
NO CONNECTION	5

PRODUCT MARKING: N/A

DEMO BOARD MCL P/N: TB-626+ SUGGESTED PCB LAYOUT (PL-348)

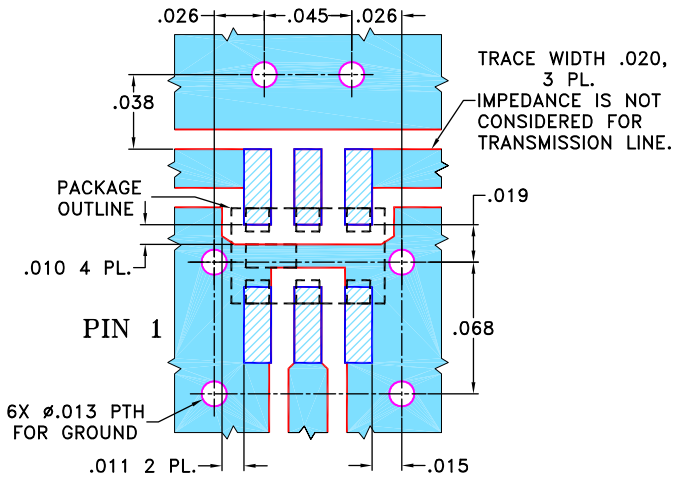

NOTES:

- TRACE WIDTH IS SHOWN FOR REFERENCE ONLY.
- BOTTOM SIDE OF THE PCB IS CONTINUOUS GROUND PLANE.

- DENOTES PCB COPPER LAYOUT WITH SMOBC (SOLDER MASK OVER BARE COPPER)
- DENOTES COPPER LAND PATTERN FREE OF SOLDER MASK

OUTLINE DRAWING

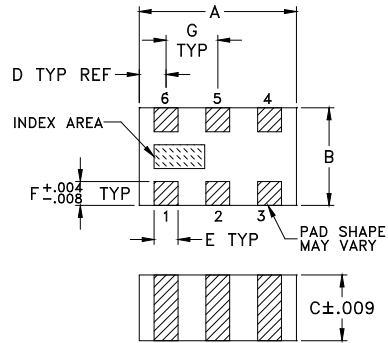

PCB Land Pattern

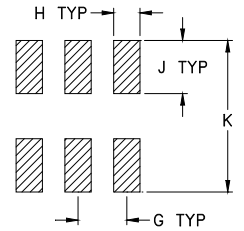

Suggested Layout,
Tolerance to be within ±.002

OUTLINE DIMENSIONS (Inches/mm)

A	B	C	D	E	F
.079	.049	.033	.014	.012	.012
2.0	1.24	0.84	0.36	0.30	0.30
G	H	J	K	wt	
.026	.014	.039	.110	grams	
0.66	0.36	1.00	2.80	.008	

TAPE & REEL INFORMATION: F74



TYPICAL PERFORMANCE DATA³

Frequency (MHz)	Insertion Loss (dB)	Input Return Loss (dB)	Amplitude Unbalance (dB)	Phase Unbalance (deg)
250	0.75	16.28	0.32	4.47
300	0.80	13.24	0.30	5.31
350	0.87	11.80	0.29	5.81
400	0.89	11.38	0.28	5.93
450	0.89	11.58	0.27	5.64
500	0.86	12.18	0.25	4.90
550	0.83	13.14	0.24	3.73
600	0.80	14.39	0.22	2.03
650	0.78	15.79	0.19	0.17
760	0.84	16.54	0.07	6.63

3. Measured with Agilent E5071B network analyzer using impedance conversion and port extension.

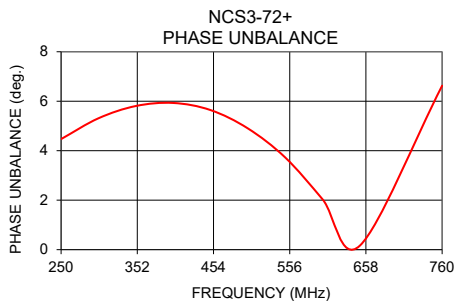
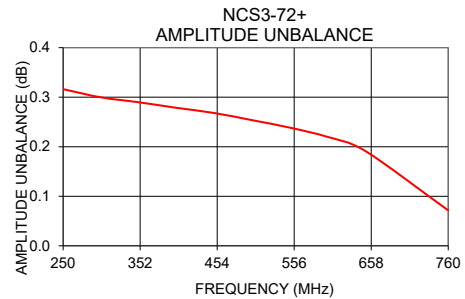
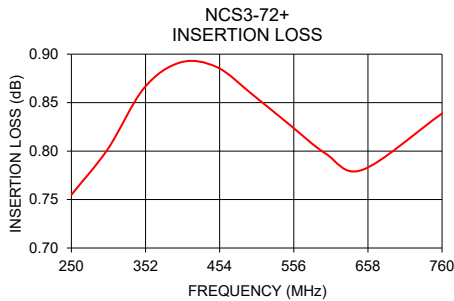

NOTES

- A. Performance and quality attributes and conditions not expressly stated in this specification document are intended to be excluded and do not form a part of this specification document.
- B. Electrical specifications and performance data contained in this specification document are based on Mini-Circuit's applicable established test performance criteria and measurement instructions.
- C. The parts covered by this specification document are subject to Mini-Circuits standard limited warranty and terms and conditions (collectively, "Standard Terms"); Purchasers of this part are entitled to the rights and benefits contained therein. For a full statement of the standard. Terms and the exclusive rights and remedies thereunder, please visit Mini-Circuits' website at www.minicircuits.com/MCLStore/terms.jsp

RF Transformer

NCS3-72+

Typical Performance Data

FREQUENCY (MHz)	INSERTION LOSS* (dB)	INPUT RETURN LOSS (dB)	AMPLITUDE UNBALANCE (dB)	PHASE UNBALANCE** (deg)
140	3.74	3.45	0.35	1.25
160	2.29	5.81	0.34	2.03
180	1.45	8.90	0.33	2.66
200	1.02	12.51	0.33	3.26
220	0.83	15.73	0.32	3.78
240	0.76	16.69	0.32	4.24
250	0.75	16.28	0.32	4.47
260	0.75	15.63	0.31	4.68
270	0.76	14.94	0.31	4.83
280	0.77	14.30	0.31	4.97
290	0.79	13.74	0.31	5.13
300	0.80	13.24	0.30	5.31
310	0.82	12.85	0.30	5.42
320	0.83	12.51	0.29	5.52
340	0.86	11.99	0.29	5.73
350	0.87	11.80	0.29	5.81
360	0.87	11.65	0.28	5.85
380	0.89	11.46	0.28	5.92
400	0.89	11.38	0.28	5.93
410	0.89	11.39	0.28	5.90
420	0.89	11.41	0.27	5.86
440	0.89	11.50	0.27	5.74
450	0.89	11.58	0.27	5.64
460	0.88	11.67	0.26	5.52
480	0.87	11.89	0.26	5.23
490	0.86	12.02	0.25	5.12
500	0.86	12.18	0.25	4.90
510	0.85	12.34	0.25	4.72
520	0.85	12.51	0.25	4.50
540	0.83	12.91	0.24	4.02
550	0.83	13.14	0.24	3.73
560	0.82	13.36	0.24	3.42
570	0.81	13.61	0.23	3.12
580	0.81	13.86	0.23	2.81
590	0.80	14.12	0.23	2.40
600	0.80	14.39	0.22	2.03
610	0.79	14.67	0.21	1.63
620	0.79	14.95	0.21	1.20
630	0.78	15.25	0.21	0.76
640	0.78	15.52	0.20	0.30
650	0.78	15.79	0.19	0.17
660	0.78	16.03	0.18	0.65
670	0.78	16.27	0.17	1.15
680	0.78	16.47	0.16	1.69
690	0.78	16.64	0.15	2.25
700	0.79	16.78	0.15	2.81
710	0.79	16.87	0.13	3.38
720	0.80	16.92	0.12	4.00
730	0.81	16.90	0.11	4.61
740	0.81	16.83	0.10	5.24
750	0.83	16.70	0.08	5.95
760	0.84	16.54	0.07	6.63
770	0.85	16.34	0.05	7.33
780	0.87	16.08	0.04	8.05
800	0.91	15.52	0.01	9.58
850	1.02	13.93	0.10	13.55

* Reference Demo Board TB-626+

**Phase Unbalance is relative to 180°



Typical Performance Data

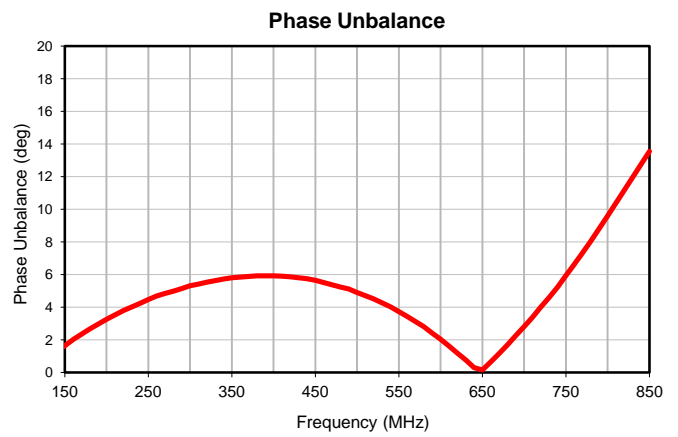
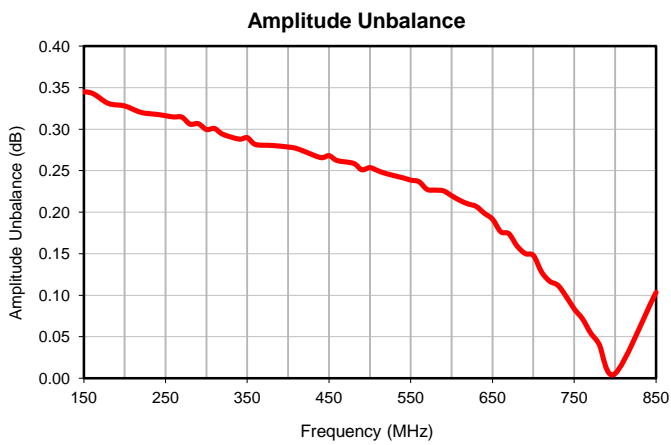
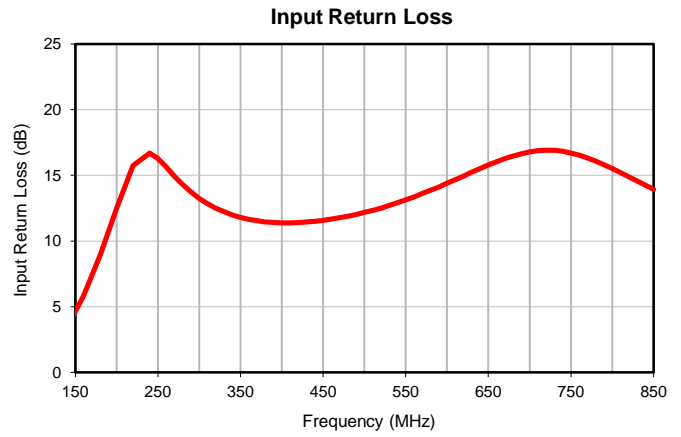
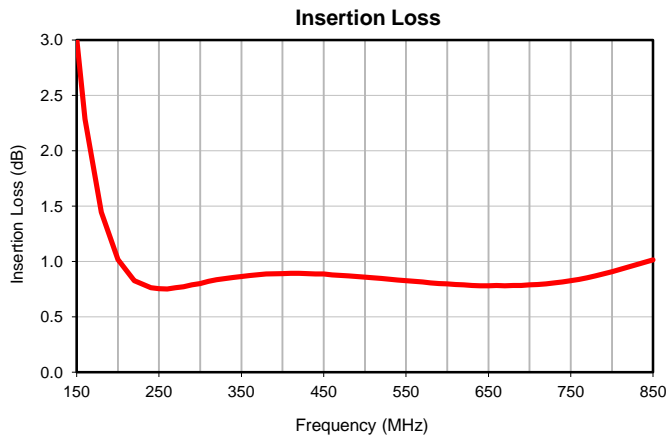

Outline Dimensions

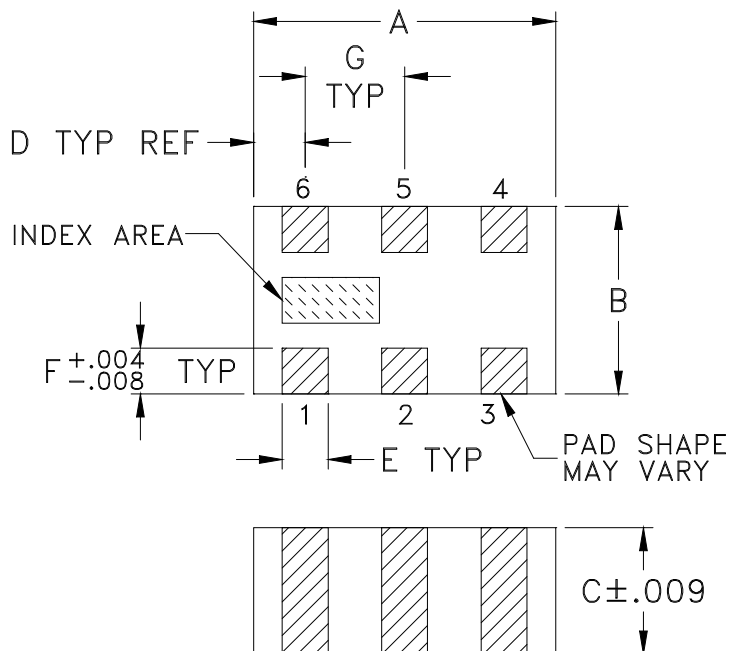

PCB Land Pattern

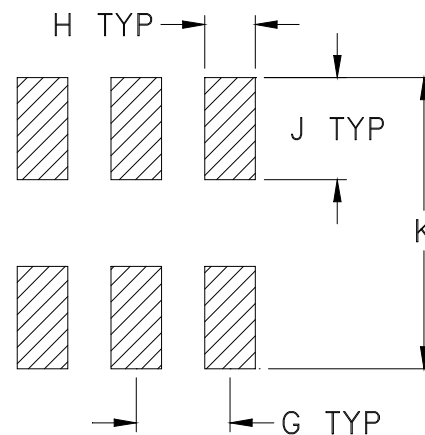

Suggested Layout,
Tolerance to be within $\pm .002$

CASE #	A	B	C	D	E	F	G	H	J	K	WT.GRAM
GE0805C-9	.079 (2.00)	.049 (1.25)	.037 (0.95)	.014 (0.35)	.012 (0.30)	.012 (0.30)	.026 (0.65)	.014 (0.35)	.039 (1.00)	.110 (2.80)	.008

Dimensions are in inches (mm). Tolerances: 2Pl. $\pm .01$; 3 Pl. $\pm .005$

Notes:

- Open style, ceramic base.
- Termination finish: For RoHS Case Styles: Tin plate over Nickel plate. All models, (+) suffix.
For RoHS-5 Case Styles: Tin-Lead plate over Nickel plate. All models, no (+) suffix.



P.O. Box 350166, Brooklyn, New York 11235-0003 (718) 934-4500 Fax (718) 332-4661 For detailed performance specs & shopping online see Mini-Circuits web site



The Design Engineers Search Engine Provides ACTUAL Data Instantly From MINI-CIRCUITS At: www.minicircuits.com

RF/IF MICROWAVE COMPONENTS

Tape & Reel Packaging TR-F114

DEVICE ORIENTATION IN T&R

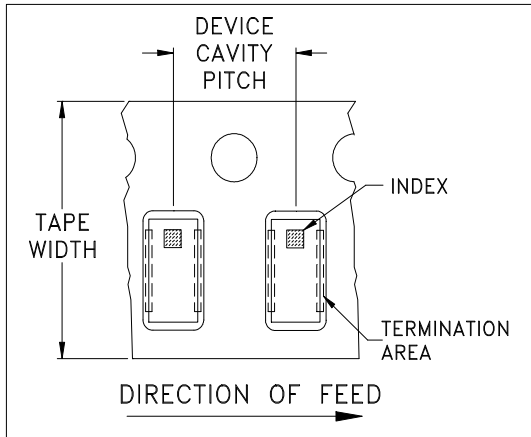

ILLUSTRATION 1

Applicable Case Styles	
GE0805C	JC0603C
GE0805C-1	JC0603C-4
GE0805C-1AP	JC0603C-6
GE0805C-7	
GE0805C-9	
GE0805C-10	
GE0805C-11	
GE0805C-12	

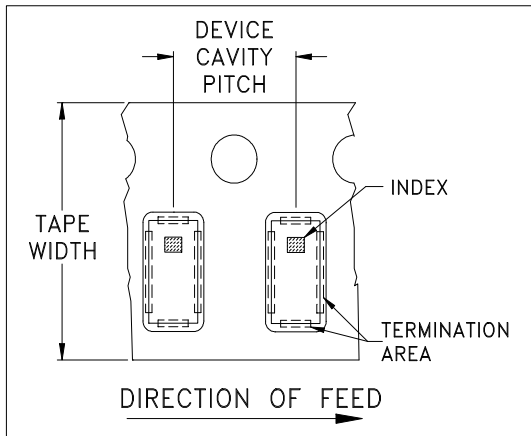

ILLUSTRATION 2

Applicable Case Styles	
GE0805C-2	JC0603C-1
GE0805C-3	JC0603C-2
GE0805C-4	JC0603C-3
GE0805C-5	JC0603C-5
GE0805C-6	JC0603C-7
GE0805C-8	JV1210C-1
GE0805C-15	

Tape Width, mm	Device Cavity Pitch, mm	Reel Size, inches	Devices per Reel	
8	4	7	Small quantity standards (see note)	20
				50
				100
				200
				500
				1000
			Standard	4000

Note: Please Consult individual model data sheet to determine device per reel availability.

Mini-Circuits carrier tape materials provide protection from ESD (Electro-Static Discharge) during handling and transportation. Tapes are static dissipative and comply with industry standards EIA-481/EIA-541.

Go to: www.minicircuits.com/pages/pdfs/tape.pdf



INTERNET <http://www.minicircuits.com>

P.O. Box 350166, Brooklyn, New York 11235-0003 (718) 934-4500 Fax (718) 332-4661

Distribution Centers NORTH AMERICA 800-654-7949 • 417-335-5935 • Fax 417-335-5945 • EUROPE 44-1252-832600 • Fax 44-1252-837010

Mini-Circuits ISO 9001 & ISO 14001 Certified

THIRD ANGLE PROJECTION

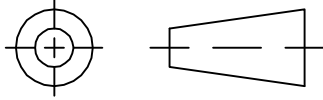

REVISIONS

REV	ECN No.	DESCRIPTION	DATE	DR	AUTH
OR	M132367	NEW RELEASE	07/20/11	GF	ABD
A	M151441	UPDATED TRACE WIDTH INFO	06/05/15	GF	WP

SUGGESTED MOUNTING CONFIGURATION FOR
GE0805C-1 CASE STYLE, "06TJ01" PIN CODE

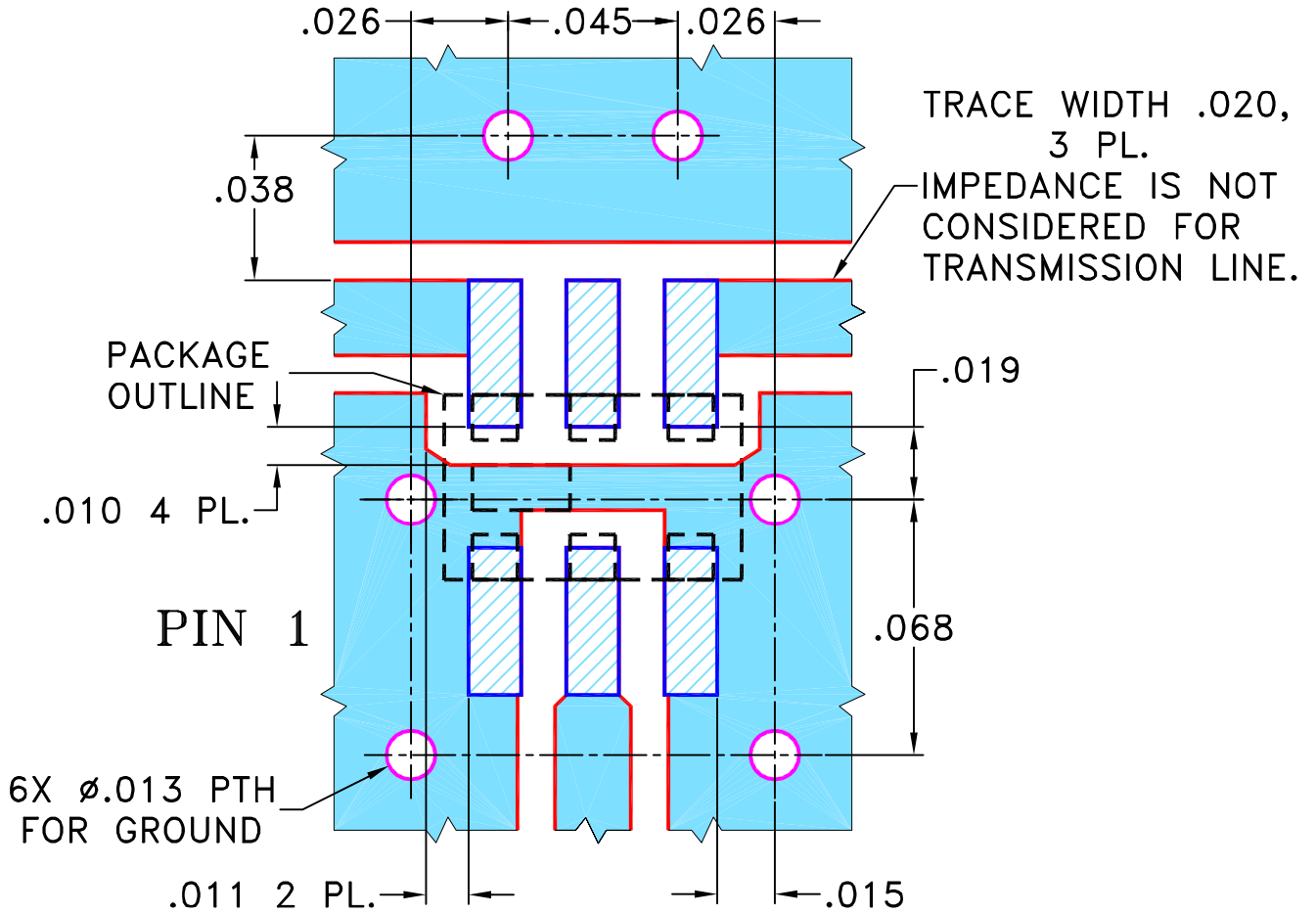

NOTES:

1. TRACE WIDTH IS SHOWN FOR REFERENCE ONLY.
2. BOTTOM SIDE OF THE PCB IS CONTINUOUS GROUND PLANE.



DENOTES PCB COPPER LAYOUT WITH SMOBC
(SOLDER MASK OVER BARE COPPER)



DENOTES COPPER LAND PATTERN FREE OF SOLDER MASK

UNLESS OTHERWISE SPECIFIED	INITIALS	DATE
DIMENSIONS ARE IN INCHES	DRAWN GF	06/20/11
TOLERANCES ON:	CHECKED IL	07/20/11
2 PL DECIMALS ±	APPROVED ABD	07/20/11
3 PL DECIMALS ± .005		
ANGLES ±		
FRACTIONS ±		



Mini-Circuits®

13 Neptune Avenue
Brooklyn NY 11235

PL, 06TJ01, GE0805C-1, TB-626+

Mini-Circuits®
THIS DOCUMENT AND ITS CONTENTS ARE THE PROPERTY OF MINI-CIRCUITS. EXCEPT FOR USE EXPRESSLY GRANTED, IN WRITING, TO ITS VENDORS, VENDEE AND THE UNITED STATES GOVERNMENT, MINI-CIRCUITS RESERVES ALL PROPRIETARY DESIGN, USE, MANUFACTURING AND REPRODUCTION RIGHTS THERETO. THESE CONTENTS SHALL NOT BE USED, DUPLICATED OR DISCLOSED TO ANY OUTSIDE PARTY, IN WHOLE OR IN PART, WITHOUT WRITTEN PERMISSION OF MINI-CIRCUITS.

SIZE	CODE IDENT	DRAWING NO:	REV:
A	15542	98-PL-348	A
FILE:	98PL348	SCALE: 20:1	SHEET: 1 OF 1

Evaluation Board and Circuit

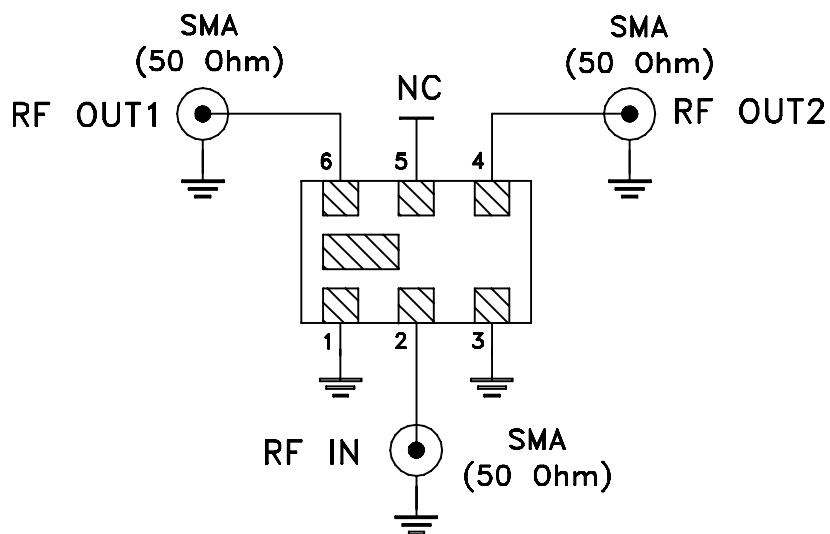
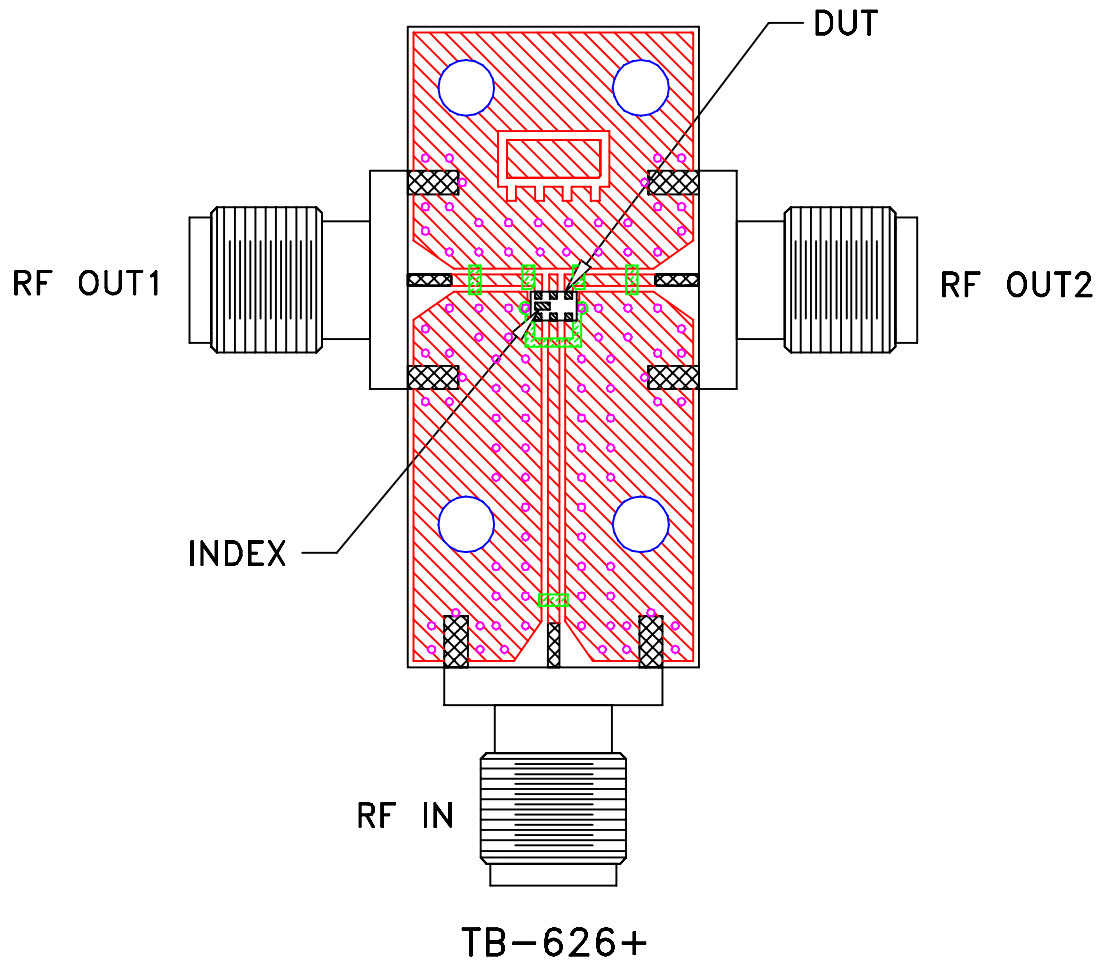

Schematic Diagram

Notes:

1. 50 Ohm SMA Female connectors.
2. PCB Material: R04350 or equivalent,
Dielectric Constant=3.5, Thickness=.010 inch.

 **Mini-Circuits®**

All Mini-Circuits products are manufactured under exacting quality assurance and control standards, and are capable of meeting published specifications after being subjected to any or all of the following physical and environmental test.

Specification	Test/Inspection Condition	Reference/Spec
Operating Temperature	-55° to 100°C Ambient Environment	Individual Model Data Sheet
Storage Temperature	-55° to 100° C Ambient Environment	Individual Model Data Sheet
Humidity	90 to 95% RH, 240 hours, 50°C	MIL-STD-202, Method 103, Condition A, Except 50°C and end-point electrical test done within 12 hours
Solder Reflow Heat	Sn-Pb Eutetic Process: 225°C peak Pb-Free Process 245° - 250°C peak	J-STD-020, Table 4-1, 4-2 and 5-2, Figure 5-1
Solderability	10X Magnification	J-STD-002, Para 4.2.5, Test S, 95% Coverage
Vibration (High Frequency)	20g peak, 10-2000 Hz, 12 times in each of three perpendicular directions (total 36)	MIL-STD-202, Method 204, Condition D
Mechanical Shock	50g, 11 ms, 1/2-sine, 18 shocks: 3 each direction, each of 3 axes	MIL-STD-202, Method 213, Condition A