

Ceramic Balun RF Transformer

NCR2-123-3+

50Ω 4700 to 12000 MHz



Generic photo used for illustration purposes only

CASE STYLE: NF1846-1

Maximum Ratings

Operating Temperature	-40°C to 85°C
Storage Temperature	-55°C to 100°C
Input RF Power	3W

Permanent damage may occur if any of these limits are exceeded.

Pad Connections

PRIMARY DOT (Unbalanced Port)	2
SECONDARY DOT (Balanced)	6
SECONDARY (Balanced)	4
GND Externally	1,3,5

Product Marking: TJ

Outline Drawing

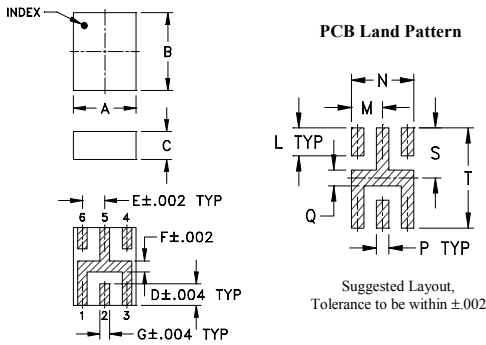

Outline Dimensions (inch/mm)

A	B	C	D	E	F	G	L
.079	.098	.035	.027	.028	.014	.014	.028
2.01	2.49	0.89	0.69	0.71	0.36	0.36	0.71
M	N	P	Q	R	S	T	wt
.035	.07	.014	.016	--	.050	.100	grams
0.89	1.78	0.36	0.41	--	1.27	0.03	0.020

Demo Board MCL P/N: TB-745+ Suggested PCB Layout (PL-425)

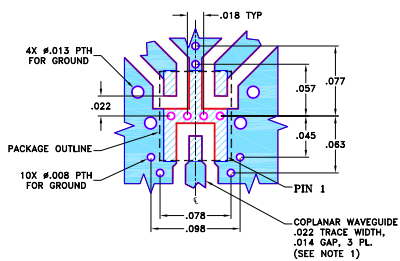

- NOTES:
- COPLANAR WAVEGUIDE PARAMETERS ARE SHOWN FOR ROGERS R04350B WITH DIELECTRIC THICKNESS .010"±.001". COPPER: 1/2 OZ. EACH SIDE. FOR OTHER MATERIALS TRACE WIDTH AND GAP MAY NEED TO BE MODIFIED.
 - BOTTOM SIDE OF THE PCB IS CONTINUOUS GROUND PLANE.
 - DENOTES PCB COPPER LAYOUT WITH SMOBC (SOLDER MASK OVER BARE COPPER).
 - DENOTES COPPER LAND PATTERN FREE OF SOLDER MASK

Notes

- Performance and quality attributes and conditions not expressly stated in this specification document are intended to be excluded and do not form a part of this specification document.
- Electrical specifications and performance data contained in this specification document are based on Mini-Circuit's applicable established test performance criteria and measurement instructions.
- The parts covered by this specification document are subject to Mini-Circuits standard limited warranty and terms and conditions (collectively, "Standard Terms"); Purchasers of this part are entitled to the rights and benefits contained therein. For a full statement of the Standard Terms and the exclusive rights and remedies thereunder, please visit Mini-Circuits' website at www.minicircuits.com/MCLStore/terms.jsp

Features

- wideband, 4700 to 12000 MHz
- miniature size, 0.079"x0.098"x0.035"
- LTCC construction
- low cost
- aqueous washable

Applications

- Point to Point
- ISM
- Radio navigation
- SATCOM

Electrical Specifications at 25°C

Parameter	Frequency (MHz)	Min.	Typ.	Max.	Unit
Impedance Ratio (secondary/primary)			2		
Frequency Range		4700	—	12000	MHz
Insertion Loss*	4700 - 12000	—	0.5	2.7	dB
Amplitude Unbalance	4700 - 12000	—	1.0	3.8	dB
Phase Unbalance†	4700 - 12000	—	8	20	Degree

* Insertion Loss is referenced to mid-band loss, 0.50 dB. Reference Demo Board TB-745+.

† Relative to 180°

Typical Performance Data at 25°C

FREQUENCY (MHz)	INSERTION LOSS (dB)	INPUT R. LOSS (dB)	AMPLITUDE UNBALANCE (dB)	PHASE UNBALANCE (Deg.)
4700.0	0.52	9.46	0.80	8.92
5460.0	0.08	14.97	0.45	11.65
6200.0	0.03	17.09	0.40	11.89
6960.0	0.09	15.34	0.45	9.42
7700.0	0.20	13.45	0.37	4.87
8460.0	0.31	12.30	0.02	0.91
9200.0	0.39	11.94	0.15	0.55
9960.0	0.40	13.10	0.40	1.26
10700.0	0.36	16.87	1.34	0.34
12000.0	0.56	16.93	2.89	4.81

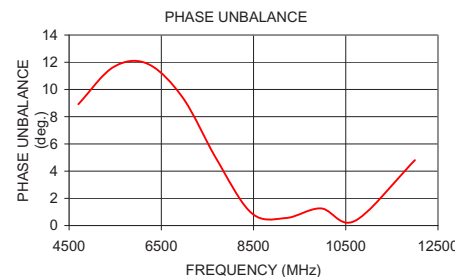
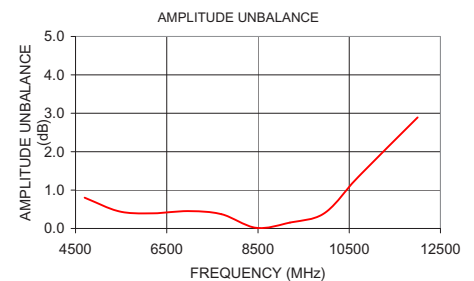
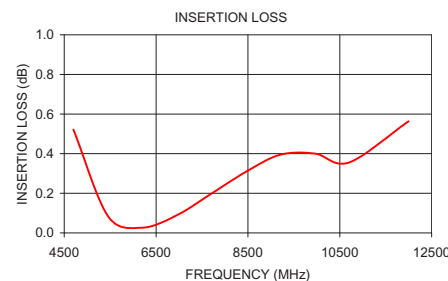

configuration J

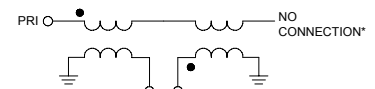

Typical Performance Data

FREQUENCY (MHz)	AVERAGE INSERTION LOSS* (dB)	INPUT RETURN LOSS (dB)	AMPLITUDE UNBALANCE (dB)	PHASE UNBALANCE** (deg.)
4700	0.52	9.46	0.80	8.92
4800	0.42	10.20	0.73	9.40
4900	0.34	10.93	0.67	9.84
5000	0.27	11.68	0.62	10.26
5100	0.21	12.41	0.56	10.62
5200	0.17	13.12	0.53	10.96
5300	0.13	13.85	0.49	11.27
5400	0.09	14.59	0.46	11.51
5500	0.07	15.26	0.44	11.74
5600	0.05	15.81	0.42	11.91
5700	0.04	16.27	0.41	12.04
5800	0.03	16.61	0.40	12.11
5900	0.03	16.84	0.39	12.14
6000	0.03	16.99	0.39	12.12
6100	0.03	17.04	0.39	12.02
6200	0.03	17.09	0.40	11.89
6300	0.03	17.01	0.39	11.74
6400	0.03	16.84	0.40	11.54
6500	0.04	16.57	0.42	11.29
6600	0.05	16.26	0.42	10.92
6700	0.06	15.99	0.43	10.57
6800	0.07	15.71	0.44	10.19
6900	0.08	15.47	0.45	9.69
7000	0.10	15.21	0.46	9.22
7100	0.11	14.96	0.45	8.63
7200	0.12	14.70	0.45	8.06
7300	0.14	14.43	0.45	7.47
7400	0.15	14.16	0.43	6.83
7500	0.17	13.86	0.42	6.20
7600	0.18	13.63	0.40	5.52
7700	0.20	13.45	0.37	4.87
7800	0.21	13.29	0.34	4.20
7900	0.23	13.13	0.29	3.57
8000	0.24	12.93	0.26	3.00
8100	0.26	12.77	0.21	2.41
8200	0.27	12.62	0.16	1.93
8300	0.29	12.45	0.10	1.50
8400	0.30	12.30	0.05	1.10
8500	0.32	12.19	0.00	0.81
8600	0.33	12.13	0.05	0.58
8700	0.34	12.10	0.09	0.41
8800	0.36	12.04	0.13	0.34
8900	0.37	11.99	0.15	0.32
9000	0.38	11.94	0.17	0.37
9100	0.39	11.95	0.17	0.43
9200	0.39	11.94	0.15	0.55
9300	0.40	11.96	0.13	0.72
9400	0.41	12.03	0.09	0.85
9500	0.41	12.17	0.03	1.02
10000	0.40	13.26	0.45	1.22
10500	0.36	15.58	1.07	0.28
11000	0.36	19.30	1.74	1.47
11500	0.43	20.78	2.33	3.38
12000	0.56	16.93	2.89	4.81

*Insertion Loss is referenced to mid-band loss, 0.50dB

**Relative to 180°

Typical Performance Data

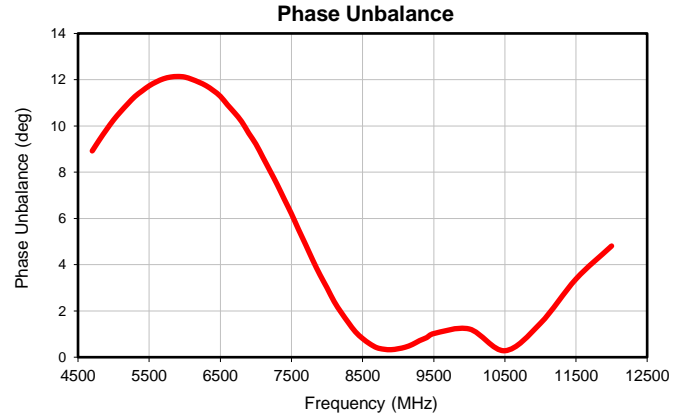
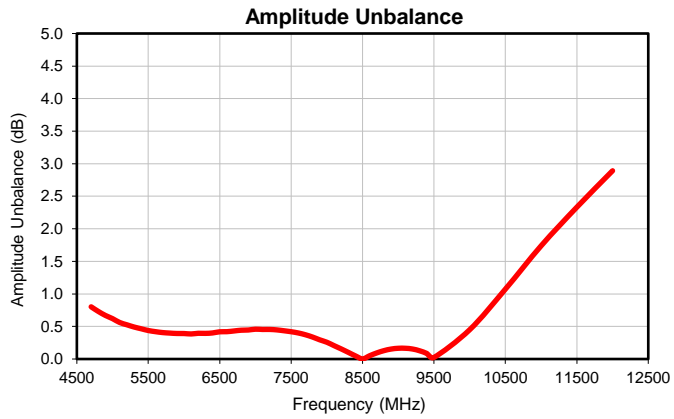
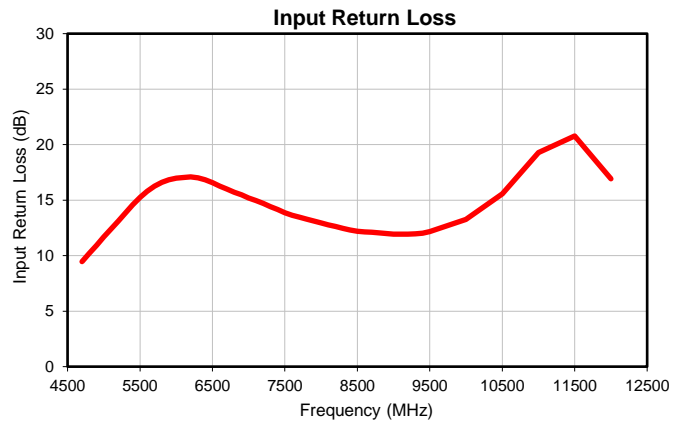
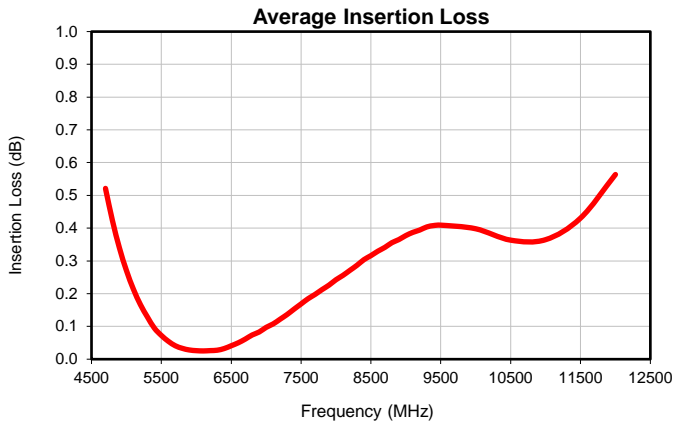

Outline Dimensions

NF1846-1

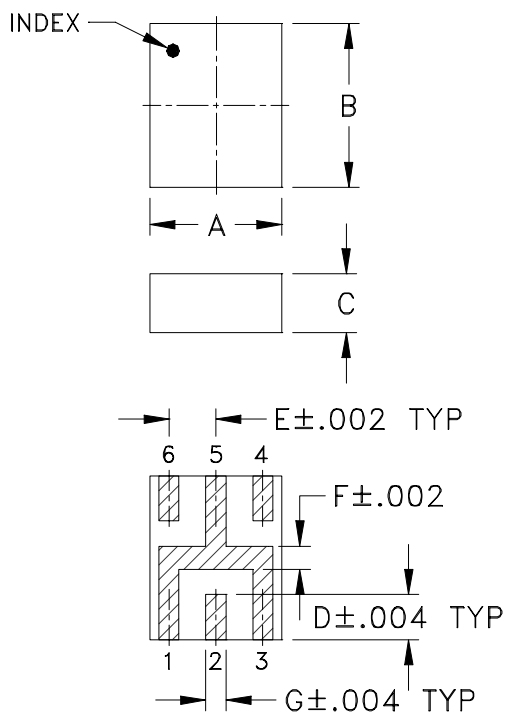

PCB Land Pattern

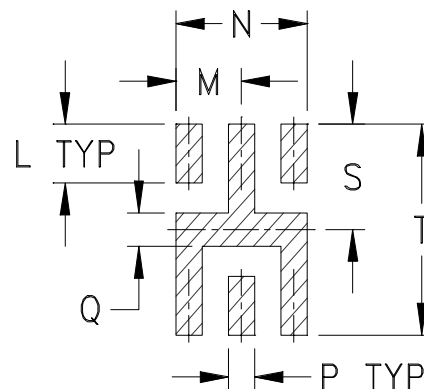

Suggested Layout,
Tolerance to be within ±.002

CASE #.	A	B	C	D	E	F	G	H	J	K	L	M	N	P
NF1846-1	.079 (2.00)	.098 (2.50)	.035 (0.89)	.027 (0.69)	.028 (0.71)	.014 (0.36)	.012 (0.30)	-	-	-	.028 (0.71)	.035 (0.89)	.07 (1.78)	.014 (0.36)

CASE #.	Q	R	S	T	WT GRAMS
NF1846-1	.016 (0.41)	-	.050 (1.27)	.100 (2.54)	.020

Dimensions are in inches (mm). Tolerances ± .005 unless specified.

Notes:

- Open style, ceramic base.
- Termination Finish:
For RoHS case style: Tin plate over Nickel plate.
All models, (+) suffix.



INTERNET <http://www.minicircuits.com>

P.O. Box 350166, Brooklyn, New York 11235-0003 (718) 934-4500 Fax (718) 332-4661

Distribution Centers NORTH AMERICA 800-654-7949 • 417-335-5935 • Fax 417-335-5945 • EUROPE 44-1252-832600 • Fax 44-1252-837010

Mini-Circuits ISO 9001 & ISO 14001 Certified

Tape & Reel Packaging TR-F66

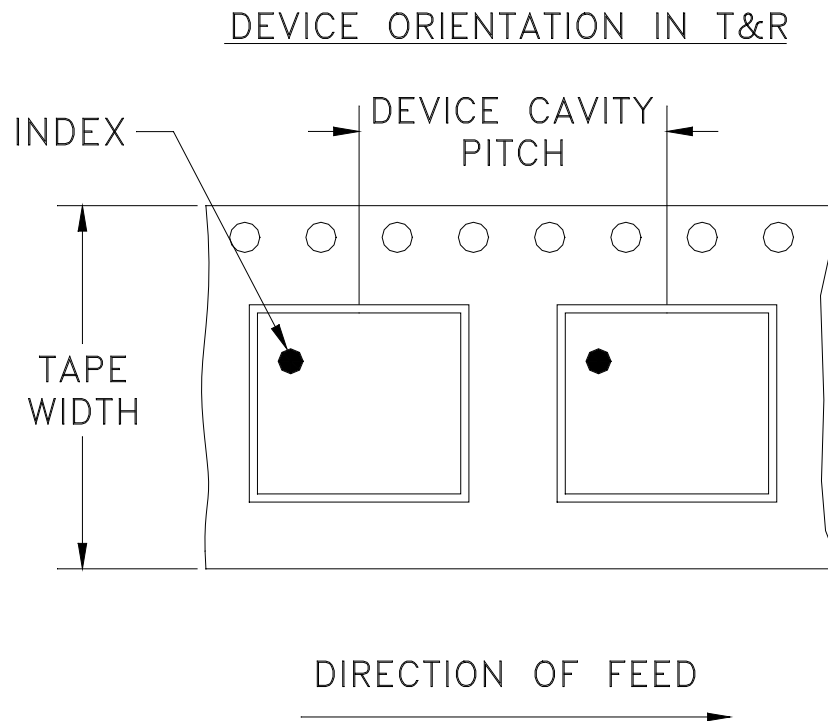

Tape Width, mm	Device Cavity Pitch, mm	Reel Size, inches	Devices per Reel see note	
8	4	7	Small quantity standard	20
				50
				100
				200
				500
		7	Standard	1000, 2000, 3000

Note: Please consult individual model data sheet to determine device per reel availability.

Mini-Circuits carrier tape materials provide protection from ESD (Electro-Static Discharge) during handling and transportation. Tapes are static dissipative and comply with industry standards EIA-481/EIA-541.

Go to: www.minicircuits.com/pages/pdfs/tape.pdf

Mini-Circuits®

INTERNET <http://www.minicircuits.com>

P.O. Box 350166, Brooklyn, New York 11235-0003 (718) 934-4500 Fax (718) 332-4661

Distribution Centers NORTH AMERICA 800-654-7949 • 417-335-5935 • Fax 417-335-5945 • EUROPE 44-1252-832600 • Fax 44-1252-837010

Mini-Circuits ISO 9001 & ISO 14001 Certified

THIRD ANGLE PROJECTION

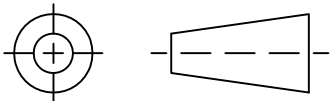

REVISIONS

REV	ECN No.	DESCRIPTION	DATE	DR	AUTH
OR	M147198	NEW RELEASE	07/14/14	ITG	AVB

SUGGESTED MOUNTING CONFIGURATION

FOR NF1846-1 CASE STYLE, "06TE01" PIN CONNECTION.

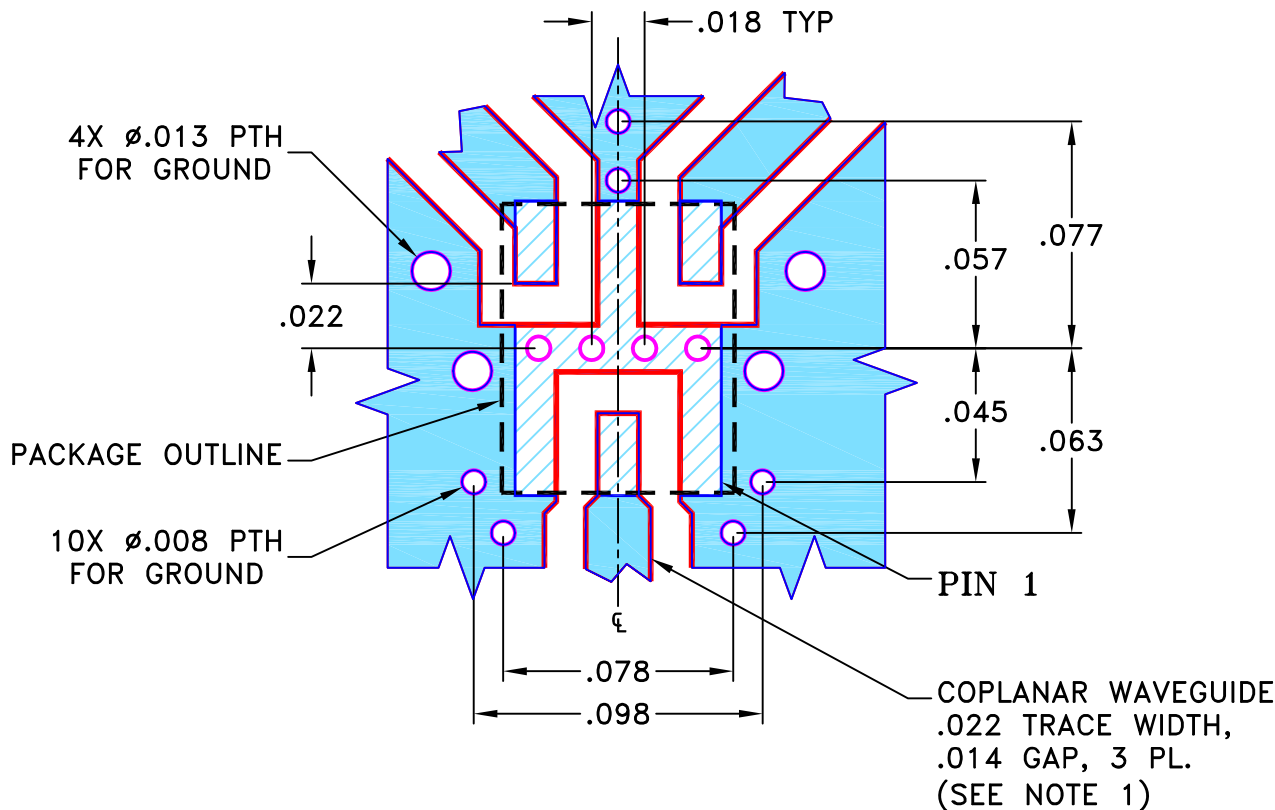

NOTES:

1. COPLANAR WAVEGUIDE PARAMETERS ARE SHOWN FOR ROGERS R04350B WITH DIELECTRIC THICKNESS .010"±.001". COPPER: 1/2 OZ. EACH SIDE. FOR OTHER MATERIALS TRACE WIDTH AND GAP MAY NEED TO BE MODIFIED.
2. BOTTOM SIDE OF THE PCB IS CONTINUOUS GROUND PLANE.

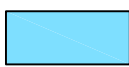

DENOTES PCB COPPER LAYOUT WITH SMOBC (SOLDER MASK OVER BARE COPPER).

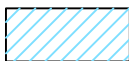

DENOTES COPPER LAND PATTERN FREE OF SOLDER MASK

UNLESS OTHERWISE SPECIFIED

INITIALS DATE

DIMENSIONS ARE IN INCHES

DRAWN ITG 07/14/14

TOLERANCES ON:

CHECKED GF 07/14/14

2 PL DECIMALS ±

APPROVED AVB 07/14/14

3 PL DECIMALS ± .005

ANGLES ±

FRACTIONS ±



Mini-Circuits®

13 Neptune Avenue
Brooklyn NY 11235

PL, 06TE01, NF1846-1, TB-745+

THIS DOCUMENT AND ITS CONTENTS ARE THE PROPERTY OF MINI-CIRCUITS. EXCEPT FOR USE EXPRESSLY GRANTED, IN WRITING, TO ITS VENDORS, VENDEE AND THE UNITED STATES GOVERNMENT, MINI-CIRCUITS RESERVES ALL PROPRIETARY DESIGN, USE, MANUFACTURING AND REPRODUCTION RIGHTS THERETO. THESE CONTENTS SHALL NOT BE USED, DUPLICATED OR DISCLOSED TO ANY OUTSIDE PARTY, IN WHOLE OR IN PART, WITHOUT WRITTEN PERMISSION OF MINI-CIRCUITS.

Mini-Circuits®

SIZE A	CODE IDENT 15542	DRAWING NO: 98-PL-425	REV: OR
FILE: 98PL425	SCALE: 15:1	SHEET: 1 OF 1	

ASHEETA1.DWG REV:A DATE:01/12/95



All Mini-Circuits products are manufactured under exacting quality assurance and control standards, and are capable of meeting published specifications after being subjected to any or all of the following physical and environmental test.

Specification	Test/Inspection Condition	Reference/Spec
Operating Temperature	-55° to 100°C Ambient Environment	Individual Model Data Sheet
Storage Temperature	-55° to 100° C Ambient Environment	Individual Model Data Sheet
Barometric Pressure	100,000 Feet	MIL-STD-202, Method 105, Condition D
Humidity	90% RH, 65°C Units may require bake-out after humidity to restore full performance.	MIL-STD-202, Method 103
Thermal Shock	-65° to 125°C, 5 cycles	MIL-STD-202, Method 107, Condition B
Vibration (High Frequency)	20g peak, 10-2000 Hz, 12 times in each of three perpendicular directions (total 36)	MIL-STD-202, Method 204, Condition D
Mechanical Shock	100g, 6ms sawtooth, 3 shocks each direction 3 axes (total 18)	MIL-STD-202, Method 213, Condition I