

# Broad Band Voltage Variable Attenuator

## MVA-2000+

50Ω 10 to 2000 MHz

### Maximum Ratings

Operating Temperature	-55°C to 85°C
Storage Temperature	-55°C to 85°C
Absolute Max. Supply Voltage(V+)	7V
Absolute Max. Control Voltage(Vctrl)	14V
Absolute Max. RF Input Level	+19 dBm
Permanent damage may occur if any of these limits are exceeded.	

### Pin Connections

RF IN	6
RF OUT	2
V CONTROL	4
V+	8
GROUND	1,3,5,7

### Outline Drawing

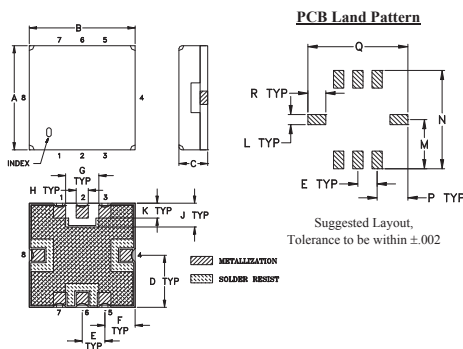

### Outline Dimensions (inch/mm)

A	B	C	D	E	F	G	H	J
.350	.350	.100	.175	.075	.100	.110	.040	.080
8.89	8.89	2.54	4.45	1.93	2.54	2.79	1.02	2.03
K	L	M	N	P	Q	R	wt.	
.050	.040	.195	.390	.120	.390	.070	grams	
1.27	1.02	4.95	9.91	3.05	9.91	1.78	0.25	

### Demo Board MCL P/N: TB-286 Suggested PCB Layout (PL-154)

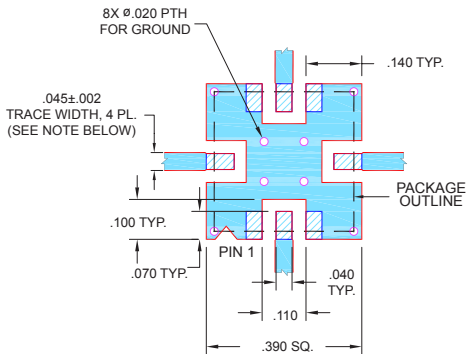

- NOTES:
- TRACE WIDTH IS SHOWN FOR FR4 WITH DIELECTRIC THICKNESS .025" ± .002"; COPPER: 1/2 OZ. EACH SIDE. FOR OTHER MATERIALS TRACE WIDTH MAY NEED TO BE MODIFIED
  - BOTTOM SIDE OF THE PCB IS CONTINUOUS GROUND PLANE.

- DENOTES PCB COPPER LAYOUT WITH SMOBC (SOLDER MASK OVER BARE COPPER)
- DENOTES COPPER LAND PATTERN FREE OF SOLDER MASK

### Features

- Broadband, 10-2000 MHz
- Low Insertion Loss, 1.9 dB typ.
- IP3, +45 dBm Typ.
- Small phase deviation over attenuation range
- No external bias and RF matching network required
- Shielded case
- Aqueous washable

### Applications

- Power level control
- Feed forward amplifiers
- CATV

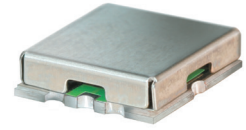

CASE STYLE: GP731

### +RoHS Compliant

The +Suffix identifies RoHS Compliance. See our web site for RoHS Compliance methodologies and qualifications

Reel Size	Devices/Reel
7"	10, 20, 50, 100, 200
13"	500, 1000

### Electrical Specifications (T<sub>AMB</sub> = 25°C)

FREQ. (MHz)	MIN. INSERTION LOSS, dB (+12V)		MAX. ATTENUATION, dB (0V)		INPUT POWER (dBm)	CONTROL Voltage Current (V) (mA)		IP3 (dBm)	RETURN LOSS (dB)	POWER SUPPLY Voltage Current (V) (mA)	
	Min.	Max.	Typ.	Max.		Typ.	Max.			Typ.	Max.
10 - 500	1.7	2.7	43	25	+19	0 - 12	15	43	23	+3 to +5	5
500 - 1000	1.9	2.8	28	20	+19	0 - 12	15	48	23	+3 to +5	5
1000 - 2000	2.1	3.0	23	15	+19	0 - 12	15	50	23	+3 to +5	5

### Notes:

- Rise/Fall time: 17μSec/10μSec Typ.
- Switching Time, turn on/off: 20μSec. Typ.
- Improved R.Loss in/out performance can be achieved at certain frequencies by choosing a V+ between +3V to +5V

### Equivalent Schematic

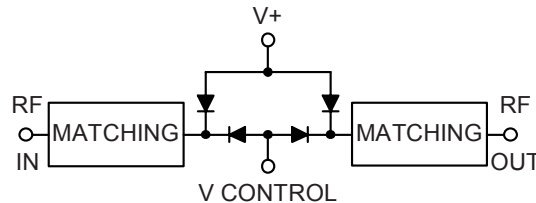

### MVA-2000+ TYPICAL ATTENUATION AT 1000MHz

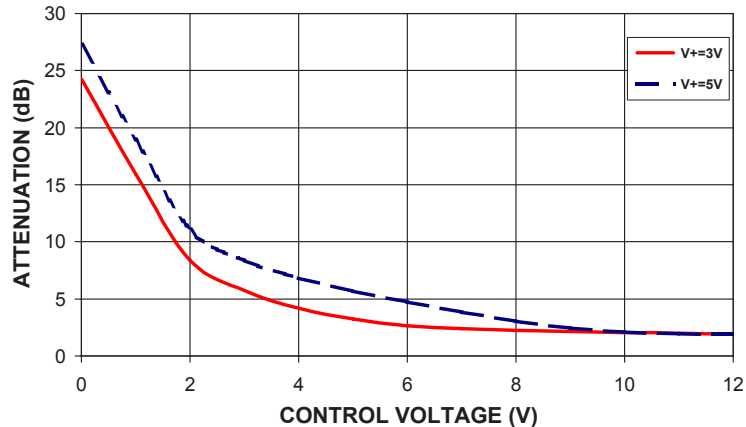

### Notes

- Performance and quality attributes and conditions not expressly stated in this specification document are intended to be excluded and do not form a part of this specification document.
- Electrical specifications and performance data contained in this specification document are based on Mini-Circuits' applicable established test performance criteria and measurement instructions.
- The parts covered by this specification document are subject to Mini-Circuits standard limited warranty and terms and conditions (collectively, "Standard Terms"); Purchasers of this part are entitled to the rights and benefits contained therein. For a full statement of the Standard Terms and the exclusive rights and remedies thereunder, please visit Mini-Circuits' website at [www.minicircuits.com/MCLStore/terms.jsp](http://www.minicircuits.com/MCLStore/terms.jsp)



**MVA-2000+**  
ATTENUATION Vs. FREQUENCY  
OVER CONTROL VOLTAGES @ V+=3V

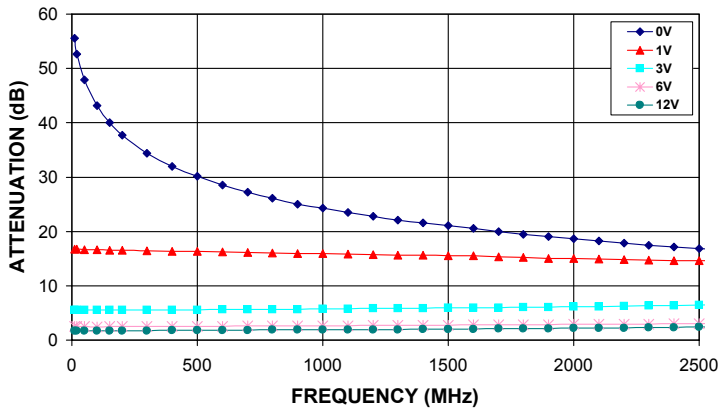

**MVA-2000+**  
ATTENUATION Vs. FREQUENCY  
OVER CONTROL VOLTAGES @ V+=5V

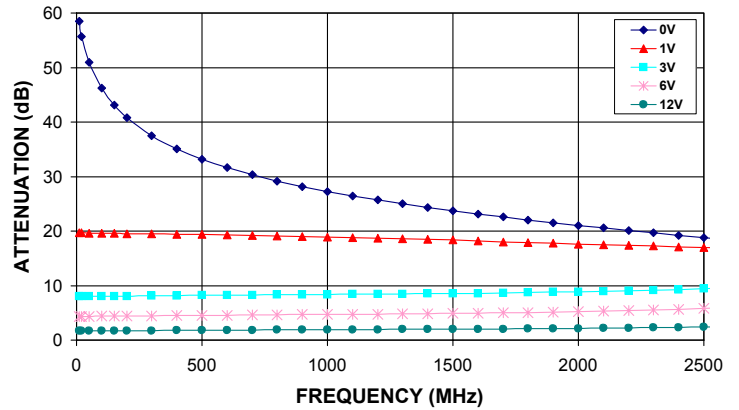

**MVA-2000+**  
ATTENUATION Vs. INPUT POWER  
OVER CONTROL VOLTAGES AT 1000MHz @ V+=3V

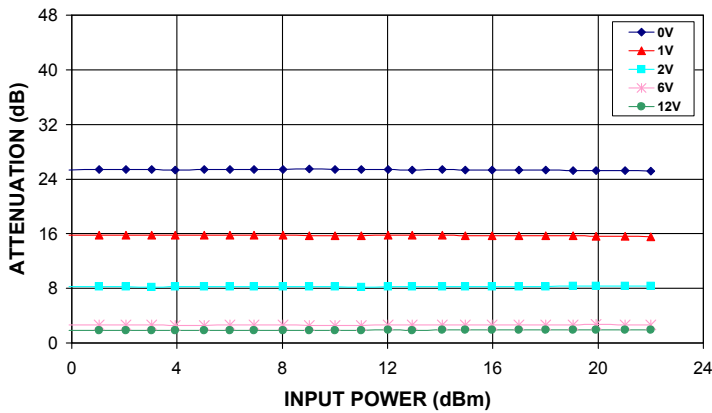

**MVA-2000+**  
ATTENUATION Vs. INPUT POWER  
OVER CONTROL VOLTAGES AT 1000MHz @ V+=5V

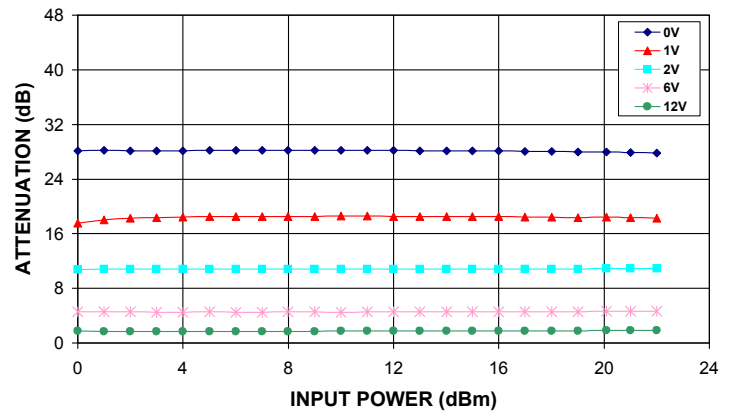

**MVA-2000+**  
INPUT RETURN LOSS Vs. FREQUENCY  
OVER CONTROL VOLTAGES @ V+=3V

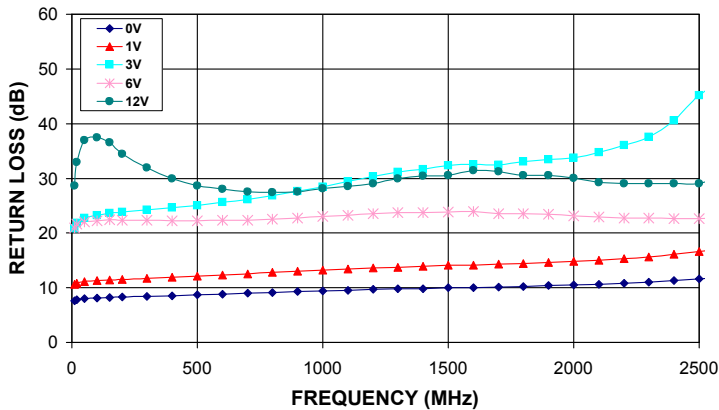

**MVA-2000+**  
INPUT RETURN LOSS Vs. FREQUENCY  
OVER CONTROL VOLTAGES @ V+=5V

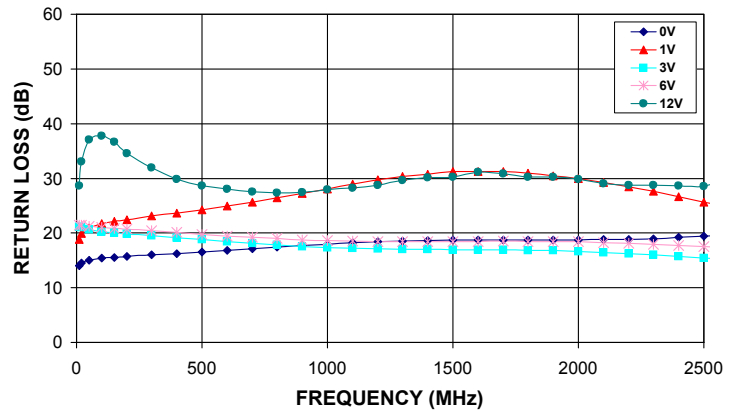

**Notes**

- A. Performance and quality attributes and conditions not expressly stated in this specification document are intended to be excluded and do not form a part of this specification document.
- B. Electrical specifications and performance data contained in this specification document are based on Mini-Circuit's applicable established test performance criteria and measurement instructions.
- C. The parts covered by this specification document are subject to Mini-Circuits standard limited warranty and terms and conditions (collectively, "Standard Terms"); Purchasers of this part are entitled to the rights and benefits contained therein. For a full statement of the Standard Terms and the exclusive rights and remedies thereunder, please visit Mini-Circuits' website at [www.minicircuits.com/MCLStore/terms.jsp](http://www.minicircuits.com/MCLStore/terms.jsp)



**MVA-2000+**  
**OUTPUT RETURN LOSS Vs. FREQUENCY**  
**OVER CONTROL VOLTAGES @ V+=3V**

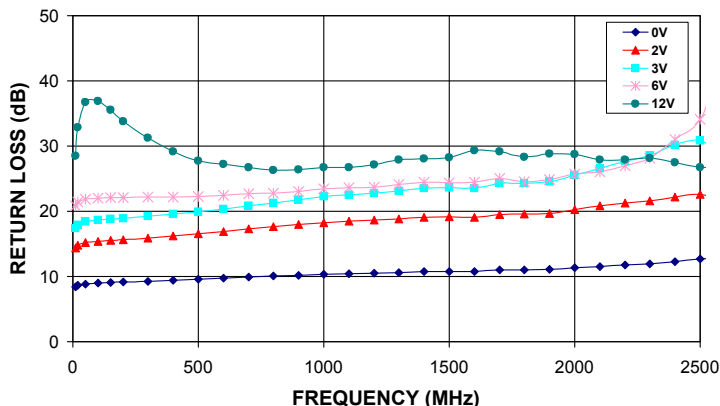

**MVA-2000+**  
**OUTPUT RETURN LOSS Vs. FREQUENCY**  
**OVER CONTROL VOLTAGES @ V+=5V**

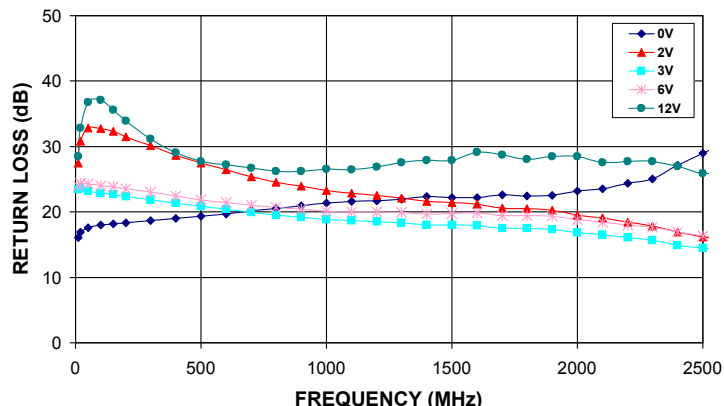

**MVA-2000+**  
**IP3 Vs. FREQUENCY**  
**OVER CONTROL VOLTAGES @ V+=3V**

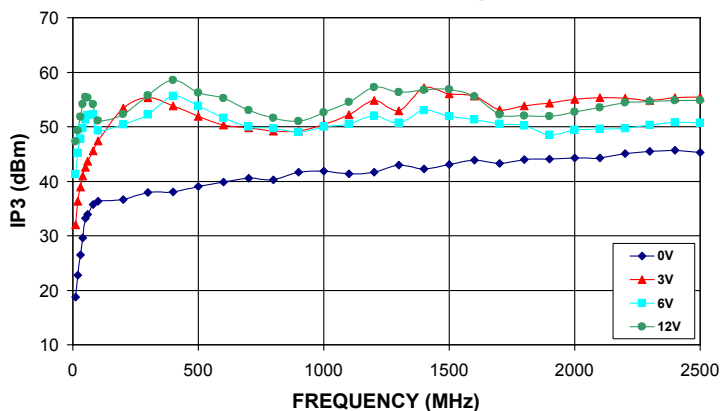

**MVA-2000+**  
**IP3 Vs. FREQUENCY**  
**OVER CONTROL VOLTAGES @ V+=5V**

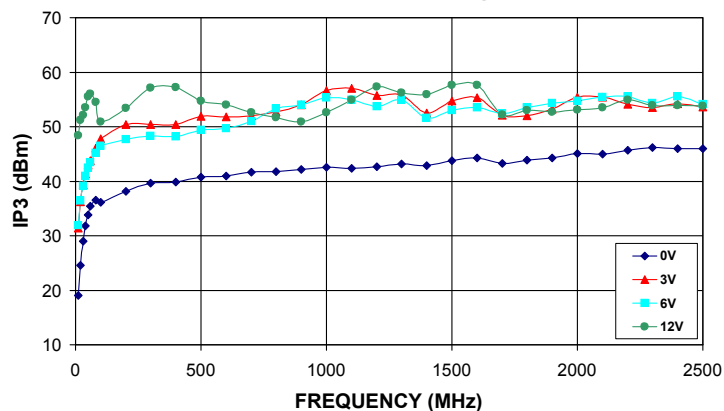

**MVA-2000+**  
**PHASE SHIFT Vs. FREQUENCY**  
**OVER CONTROL VOLTAGES @ V+=3V**

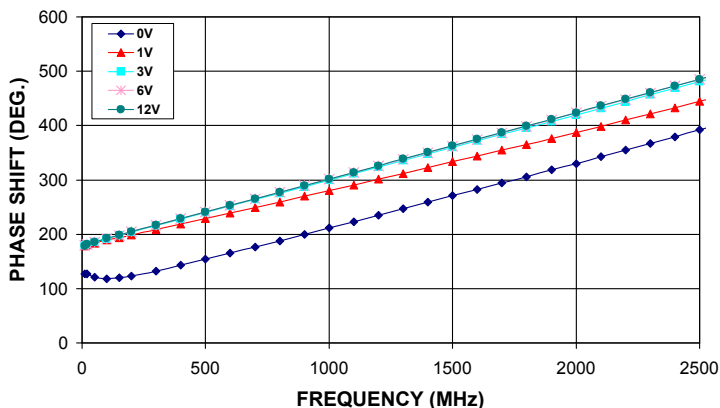

**MVA-2000+**  
**PHASE SHIFT Vs. FREQUENCY**  
**OVER CONTROL VOLTAGES @ V+=5V**

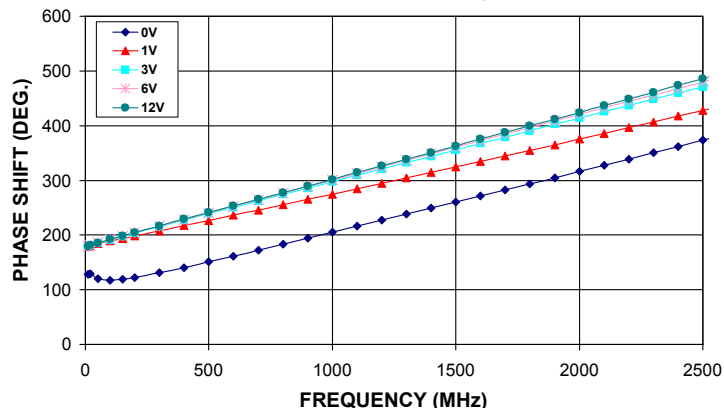

**Notes**

- A. Performance and quality attributes and conditions not expressly stated in this specification document are intended to be excluded and do not form a part of this specification document.
- B. Electrical specifications and performance data contained in this specification document are based on Mini-Circuit's applicable established test performance criteria and measurement instructions.
- C. The parts covered by this specification document are subject to Mini-Circuits standard limited warranty and terms and conditions (collectively, "Standard Terms"); Purchasers of this part are entitled to the rights and benefits contained therein. For a full statement of the Standard Terms and the exclusive rights and remedies thereunder, please visit Mini-Circuits' website at [www.minicircuits.com/MCLStore/terms.jsp](http://www.minicircuits.com/MCLStore/terms.jsp)



# Voltage Variable Attenuator

# MVA-2000+

## Typical Performance Data

V CONTROL (V)	ATTENUATION @ 1000 MHz (dB)	
	@V+=3V	@V+=5V
	0.0	24.26
1.0	15.89	18.93
2.0	8.35	11.05
3.0	5.73	8.38
4.0	4.17	6.82
5.0	3.23	5.67
6.0	2.63	4.71
7.0	2.41	3.82
8.0	2.26	3.02
9.0	2.14	2.46
10.0	2.05	2.08
11.0	1.98	1.96
12.0	1.91	1.89

FREQ. (MHz)	ATTENUATION Vs. V CONTROL Vs. V+									
	(dB)									
	@V Control=0V		@V Control=1V		@V Control=3V		@V Control=6V		@V Control=12V	
	@V+=3V	@V+=5V	@V+=3V	@V+=5V	@V+=3V	@V+=5V	@V+=3V	@V+=5V	@V+=3V	@V+=5V
10	55.55	58.51	16.78	19.71	5.57	8.03	2.51	4.33	1.73	1.72
20	52.61	55.69	16.70	19.66	5.55	8.04	2.49	4.33	1.71	1.71
50	47.86	50.94	16.62	19.63	5.54	8.08	2.49	4.35	1.72	1.71
100	43.17	46.23	16.59	19.58	5.54	8.07	2.47	4.38	1.71	1.71
150	40.01	43.10	16.51	19.56	5.51	8.09	2.48	4.39	1.72	1.71
200	37.72	40.76	16.52	19.54	5.54	8.09	2.49	4.39	1.73	1.73
300	34.39	37.49	16.45	19.49	5.55	8.12	2.51	4.43	1.74	1.73
400	31.97	35.07	16.38	19.43	5.58	8.18	2.53	4.48	1.77	1.77
500	30.11	33.19	16.32	19.37	5.59	8.20	2.55	4.51	1.80	1.79
600	28.55	31.65	16.25	19.27	5.62	8.22	2.56	4.53	1.83	1.82
700	27.24	30.33	16.15	19.20	5.65	8.27	2.58	4.58	1.86	1.84
800	26.08	29.17	16.04	19.12	5.66	8.32	2.60	4.63	1.88	1.86
900	25.05	28.13	15.92	18.99	5.68	8.36	2.60	4.68	1.90	1.88
1000	24.26	27.25	15.89	18.93	5.73	8.38	2.63	4.71	1.91	1.89
1100	23.47	26.43	15.83	18.82	5.77	8.41	2.65	4.75	1.93	1.92
1200	22.79	25.69	15.75	18.71	5.80	8.43	2.68	4.77	1.94	1.94
1300	22.12	24.99	15.65	18.59	5.82	8.48	2.70	4.81	1.96	1.97
1400	21.57	24.34	15.61	18.47	5.87	8.51	2.72	4.84	1.98	1.98
1500	21.03	23.74	15.54	18.36	5.93	8.55	2.75	4.89	2.01	2.01
1600	20.56	23.16	15.50	18.21	5.98	8.58	2.79	4.93	2.04	2.04
1700	20.01	22.58	15.36	18.04	6.00	8.63	2.81	4.99	2.07	2.06
1800	19.51	22.06	15.22	17.90	6.04	8.72	2.84	5.07	2.12	2.11
1900	19.02	21.54	15.06	17.77	6.08	8.82	2.85	5.17	2.16	2.13
2000	18.63	21.04	14.98	17.62	6.13	8.88	2.88	5.24	2.18	2.16
2100	18.22	20.58	14.88	17.49	6.18	8.98	2.90	5.34	2.20	2.20
2200	17.88	20.12	14.81	17.34	6.24	9.05	2.94	5.41	2.25	2.24
2300	17.49	19.66	14.73	17.24	6.31	9.18	2.96	5.53	2.27	2.27
2400	17.15	19.23	14.65	17.11	6.38	9.29	3.01	5.64	2.32	2.32
2500	16.86	18.83	14.63	16.98	6.49	9.44	3.05	5.78	2.38	2.37

REV. X1  
MVA-2000+  
070704  
Page 1 of 5



IF/RF MICROWAVE COMPONENTS • ISO 9001 ISO 14001 AS 9100 CERTIFIED RoHS compliant  
P.O. Box 350166, Brooklyn, New York 11235-0003 (718) 934-4500 Fax (718) 332-4661



The Design Engineers Search Engine finds the model you need, Instantly • For detailed performance specs & shopping online see



# Voltage Variable Attenuator

# MVA-2000+

## Typical Performance Data

FREQ. (MHz)	INPUT RETURN LOSS Vs. V CONTROL Vs. V+									
	(dB)									
	@V Control=0V		@V Control=1V		@V Control=3V		@V Control=6V		@V Control=12V	
	@V+=3V	@V+=5V	@V+=3V	@V+=5V	@V+=3V	@V+=5V	@V+=3V	@V+=5V	@V+=3V	@V+=5V
10	7.65	13.99	10.57	18.81	20.87	21.12	20.96	21.42	28.61	28.66
20	7.84	14.54	10.86	19.95	21.85	20.99	21.63	21.48	33.00	33.05
50	8.04	15.04	11.15	20.96	22.69	20.62	22.05	21.26	36.98	37.11
100	8.16	15.38	11.33	21.72	23.26	20.26	22.24	21.00	37.51	37.78
150	8.24	15.56	11.45	22.12	23.64	20.03	22.41	20.81	36.54	36.69
200	8.29	15.70	11.53	22.46	23.80	19.85	22.37	20.70	34.44	34.59
300	8.42	15.99	11.73	23.09	24.23	19.50	22.36	20.39	31.99	31.98
400	8.54	16.24	11.92	23.65	24.60	19.16	22.27	20.10	29.94	29.86
500	8.68	16.51	12.12	24.26	25.03	18.81	22.24	19.78	28.64	28.68
600	8.85	16.80	12.36	24.96	25.65	18.43	22.37	19.44	28.05	28.06
700	8.99	17.09	12.57	25.61	26.15	18.12	22.37	19.20	27.56	27.59
800	9.14	17.41	12.81	26.48	26.84	17.84	22.49	18.99	27.42	27.39
900	9.29	17.71	13.02	27.28	27.65	17.56	22.71	18.73	27.54	27.49
1000	9.41	17.96	13.23	28.08	28.48	17.37	23.00	18.64	28.13	27.97
1100	9.55	18.20	13.45	28.96	29.40	17.23	23.23	18.52	28.50	28.26
1200	9.67	18.39	13.62	29.70	30.34	17.09	23.51	18.44	29.07	28.79
1300	9.77	18.54	13.77	30.31	31.14	17.03	23.73	18.44	29.93	29.61
1400	9.86	18.61	13.92	30.80	31.63	17.01	23.74	18.44	30.41	30.13
1500	9.97	18.69	14.08	31.25	32.33	16.91	23.84	18.39	30.60	30.30
1600	10.05	18.69	14.17	31.25	32.52	16.94	23.90	18.46	31.46	31.16
1700	10.15	18.69	14.29	31.23	32.45	16.93	23.57	18.52	31.25	30.82
1800	10.26	18.69	14.44	31.00	33.09	16.85	23.55	18.46	30.58	30.24
1900	10.37	18.73	14.61	30.50	33.43	16.78	23.40	18.43	30.58	30.23
2000	10.49	18.74	14.80	29.97	33.80	16.66	23.09	18.40	30.08	29.84
2100	10.66	18.80	15.07	29.27	34.80	16.47	22.89	18.28	29.29	29.02
2200	10.86	18.88	15.37	28.42	36.05	16.26	22.77	18.12	29.01	28.78
2300	11.06	18.98	15.67	27.61	37.54	16.04	22.71	17.96	29.07	28.70
2400	11.34	19.20	16.14	26.68	40.57	15.74	22.65	17.75	29.01	28.64
2500	11.62	19.39	16.60	25.69	45.15	15.45	22.64	17.52	29.05	28.5

REV. X1  
MVA-2000+  
070704  
Page 2 of 5



IF/RF MICROWAVE COMPONENTS • ISO 9001 ISO 14001 AS 9100 CERTIFIED • RoHS compliant  
P.O. Box 350166, Brooklyn, New York 11235-0003 (718) 934-4500 Fax (718) 332-4661



The Design Engineers Search Engine finds the model you need, Instantly • For detailed performance specs & shopping online see



# Voltage Variable Attenuator

# MVA-2000+

## Typical Performance Data

FREQ. (MHz)	OUTPUT RETURN LOSS Vs. V CONTROL Vs. V+									
	(dB)									
	@V Control=0V		@V Control=2V		@V Control=3V		@V Control=6V		@V Control=12V	
	@V+=3V	@V+=5V	@V+=3V	@V+=5V	@V+=3V	@V+=5V	@V+=3V	@V+=5V	@V+=3V	@V+=5V
10	8.42	16.05	14.39	27.51	17.40	23.45	20.81	23.95	28.47	28.51
20	8.65	16.88	14.78	30.82	17.93	23.59	21.47	24.35	32.85	32.86
50	8.86	17.56	15.18	32.82	18.38	23.24	21.88	24.26	36.75	36.76
100	8.99	17.97	15.39	32.75	18.62	22.88	22.02	24.03	36.93	37.08
150	9.05	18.17	15.53	32.37	18.81	22.68	22.12	23.84	35.57	35.61
200	9.12	18.38	15.65	31.51	18.93	22.36	22.13	23.51	33.79	33.93
300	9.24	18.68	15.91	30.15	19.24	21.89	22.22	23.02	31.27	31.19
400	9.40	19.04	16.22	28.66	19.60	21.36	22.22	22.42	29.13	29.10
500	9.56	19.36	16.52	27.45	19.92	20.87	22.25	21.88	27.75	27.74
600	9.71	19.71	16.88	26.48	20.34	20.42	22.43	21.48	27.24	27.19
700	9.89	20.18	17.27	25.41	20.86	19.91	22.68	20.99	26.73	26.68
800	10.05	20.56	17.61	24.58	21.27	19.50	22.78	20.65	26.29	26.20
900	10.19	20.91	17.95	23.97	21.74	19.19	23.03	20.40	26.35	26.23
1000	10.35	21.38	18.27	23.28	22.24	18.86	23.48	20.14	26.75	26.54
1100	10.45	21.57	18.51	22.89	22.56	18.65	23.59	20.04	26.70	26.49
1200	10.51	21.73	18.64	22.57	22.75	18.49	23.73	20.00	27.14	26.90
1300	10.61	21.98	18.82	22.15	23.10	18.32	24.11	19.92	27.86	27.59
1400	10.74	22.32	19.10	21.61	23.56	18.01	24.47	19.68	28.08	27.85
1500	10.79	22.23	19.17	21.48	23.60	17.97	24.35	19.74	28.22	27.92
1600	10.79	22.19	19.04	21.21	23.50	17.89	24.49	19.82	29.34	29.12
1700	10.97	22.64	19.49	20.62	24.28	17.52	25.05	19.42	29.12	28.72
1800	11.03	22.42	19.59	20.56	24.28	17.48	24.57	19.40	28.35	28.08
1900	11.11	22.52	19.70	20.24	24.55	17.32	24.88	19.33	28.85	28.45
2000	11.33	23.23	20.26	19.50	25.58	16.84	25.71	18.82	28.73	28.51
2100	11.54	23.54	20.82	19.07	26.59	16.51	26.01	18.42	27.87	27.56
2200	11.77	24.34	21.27	18.41	27.67	16.05	27.00	18.02	27.93	27.69
2300	11.93	25.02	21.57	17.85	28.53	15.66	28.17	17.68	28.17	27.70
2400	12.31	27.13	22.18	16.89	30.20	14.94	31.05	16.93	27.52	26.93
2500	12.65	28.95	22.58	16.20	30.88	14.45	34.10	16.37	26.71	25.90

REV. X1  
MVA-2000+  
070704  
Page 3 of 5



IF/RF MICROWAVE COMPONENTS • ISO 9001 ISO 14001 AS 9100 CERTIFIED • RoHS compliant  
P.O. Box 350166, Brooklyn, New York 11235-0003 (718) 934-4500 Fax (718) 332-4661



The Design Engineers Search Engine finds the model you need, Instantly • For detailed performance specs & shopping online see



# Voltage Variable Attenuator

# MVA-2000+

## Typical Performance Data

FREQ. (MHz)	INPUT IP3 Vs. V CONTROL Vs. V+							
	(dBm)							
	@V Control=0V		@V Control=3V		@V Control=6V		@V Control=12V	
	@V+=3V	@V+=5V	@V+=3V	@V+=5V	@V+=3V	@V+=5V	@V+=3V	@V+=5V
10	18.77	19.08	32.03	31.42	41.30	31.87	47.28	48.41
20	22.75	24.58	36.37	36.28	45.18	36.44	49.32	51.19
30	26.51	28.99	38.98	39.35	47.78	39.15	51.79	52.14
40	29.62	31.85	40.92	41.31	49.66	40.93	54.11	53.56
50	33.23	33.86	42.60	42.98	51.27	42.43	55.45	55.56
60	33.93	35.47	43.69	43.81	52.08	43.42	55.34	56.00
80	35.75	36.52	45.53	46.04	52.26	45.18	54.13	54.54
100	36.33	36.10	47.36	47.76	49.30	46.51	51.12	50.91
200	36.63	38.12	53.42	50.45	50.44	47.68	52.29	53.43
300	37.97	39.64	55.33	50.43	52.26	48.30	55.71	57.09
400	38.03	39.84	53.83	50.37	55.63	48.20	58.54	57.23
500	39.04	40.80	51.90	51.95	53.78	49.35	56.23	54.73
600	39.83	40.98	50.29	51.77	51.62	49.71	55.24	54.06
700	40.59	41.69	49.84	52.03	49.99	50.99	52.97	52.64
800	40.26	41.71	49.24	52.67	49.70	53.30	51.58	51.75
900	41.61	42.19	49.19	53.97	48.99	53.98	50.97	50.86
1000	41.85	42.56	50.43	56.61	49.97	55.32	52.63	52.64
1100	41.38	42.36	52.19	57.08	50.49	54.92	54.51	54.91
1200	41.64	42.67	54.87	55.73	52.06	53.71	57.28	57.33
1300	42.92	43.12	52.94	55.83	50.72	54.94	56.33	56.20
1400	42.28	42.85	57.17	52.53	53.02	51.56	56.78	55.97
1500	43.04	43.81	56.03	54.70	51.95	53.03	56.79	57.68
1600	43.84	44.30	55.64	55.35	51.29	53.50	55.53	57.59
1700	43.26	43.25	53.10	52.11	50.48	52.40	52.18	52.18
1800	43.96	43.86	53.79	52.05	50.20	53.47	52.06	53.04
1900	44.12	44.28	54.28	53.25	48.53	54.31	51.86	52.69
2000	44.30	45.04	55.00	55.44	49.43	54.72	52.67	53.12
2100	44.29	45.01	55.30	55.39	49.56	55.43	53.47	53.47
2200	45.08	45.68	55.19	54.13	49.70	55.48	54.41	54.88
2300	45.49	46.21	54.82	53.51	50.33	54.32	54.65	53.92
2400	45.64	45.96	55.35	54.24	50.78	55.55	54.82	53.87
2500	45.27	45.99	55.44	53.65	50.73	54.15	54.78	53.85

REV. X1  
MVA-2000+  
070704  
Page 4 of 5



IF/RF MICROWAVE COMPONENTS • ISO 9001 ISO 14001 AS 9100 CERTIFIED RoHS compliant  
P.O. Box 350166, Brooklyn, New York 11235-0003 (718) 934-4500 Fax (718) 332-4661



The Design Engineers Search Engine finds the model you need, Instantly • For detailed performance specs & shopping online see





# Voltage Variable Attenuator

# MVA-2000+

## Typical Performance Data

FREQ. (MHz)	PHASE SHIFT Vs. V CONTROL Vs. V+									
	(deg)									
	@V Control=0V		@V Control=1V		@V Control=3V		@V Control=6V		@V Control=12V	
	@V+=3V	@V+=5V	@V+=3V	@V+=5V	@V+=3V	@V+=5V	@V+=3V	@V+=5V	@V+=3V	@V+=5V
10	126.64	128.23	178.45	179.07	179.16	179.48	179.06	179.30	178.98	179.04
20	127.53	129.13	180.23	180.74	181.31	181.55	181.32	181.60	181.36	181.28
50	120.70	120.04	183.74	183.90	185.46	185.63	185.56	185.87	185.65	185.62
100	117.61	117.56	189.12	188.93	191.75	191.80	192.01	192.15	192.12	192.12
150	119.68	118.78	194.07	193.58	197.86	197.75	198.14	198.30	198.32	198.28
200	123.13	122.28	199.07	198.28	203.95	203.72	204.31	204.44	204.53	204.51
300	132.51	130.91	209.07	207.81	215.97	215.58	216.49	216.55	216.78	216.78
400	143.12	140.57	219.14	217.10	228.02	227.39	228.63	228.70	228.98	229.00
500	154.00	150.86	229.17	226.65	239.96	239.05	240.74	240.67	241.14	241.17
600	165.21	161.53	239.36	236.26	251.92	250.80	252.94	252.76	253.34	253.39
700	176.36	172.06	249.34	245.84	263.80	262.54	264.92	264.86	265.45	265.50
800	188.05	182.94	259.55	255.37	275.76	274.20	277.04	276.82	277.61	277.65
900	199.78	193.93	270.04	265.22	287.77	285.85	289.13	288.81	289.65	289.71
1000	211.79	205.01	280.62	274.92	299.79	297.43	301.30	300.70	301.83	301.99
1100	223.31	215.97	290.77	284.74	311.68	309.11	313.41	312.66	314.00	314.16
1200	235.15	227.04	301.26	294.53	323.65	320.76	325.55	324.61	326.20	326.38
1300	246.88	238.16	311.78	304.40	335.67	332.43	337.76	336.71	338.41	338.56
1400	258.82	249.17	322.55	314.44	347.71	343.90	349.99	348.50	350.61	350.75
1500	270.86	260.33	333.40	324.49	359.72	355.46	362.22	360.44	362.88	363.00
1600	282.51	271.48	343.83	334.41	371.75	367.13	374.44	372.39	375.12	375.22
1700	294.43	282.60	354.60	344.57	383.73	378.92	386.56	384.48	387.29	387.44
1800	305.96	293.75	365.37	354.89	395.65	390.66	398.79	396.58	399.50	399.72
1900	318.32	304.97	376.52	365.04	407.83	402.27	410.89	408.57	411.72	411.95
2000	330.21	316.27	387.50	375.41	419.81	413.89	423.17	420.49	423.95	424.17
2100	342.36	327.53	398.79	385.95	431.98	425.40	435.55	432.40	436.21	436.53
2200	354.54	338.91	409.95	396.20	444.10	436.92	447.81	444.31	448.49	448.84
2300	367.19	350.44	421.69	406.70	456.35	448.25	460.16	455.96	460.70	461.05
2400	379.27	361.69	432.74	417.29	468.46	459.85	472.54	467.94	473.05	473.41
2500	391.91	373.31	444.61	427.59	480.68	470.95	484.94	479.40	485.32	485.70



# Voltage Variable Attenuator

## Typical Performance Curves

MVA-2000+

Attenuation @ 1000 MHz

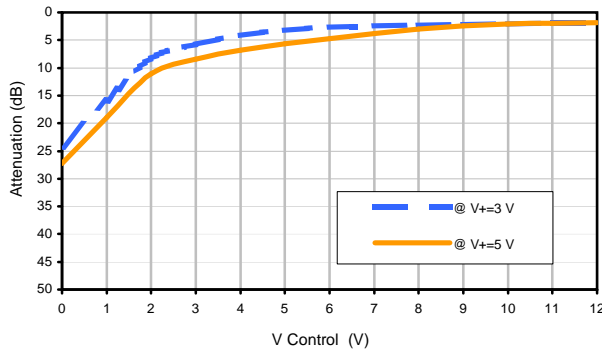

Attenuation @ V+=3 V

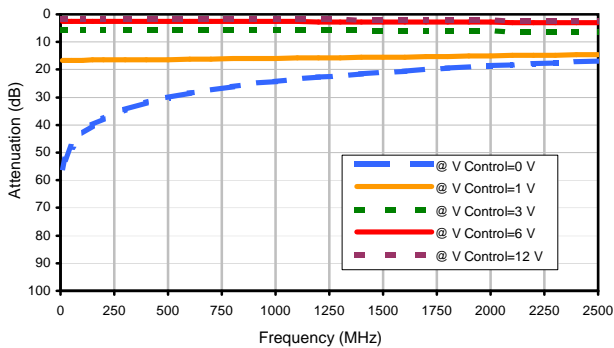

Attenuation @ V+=5 V

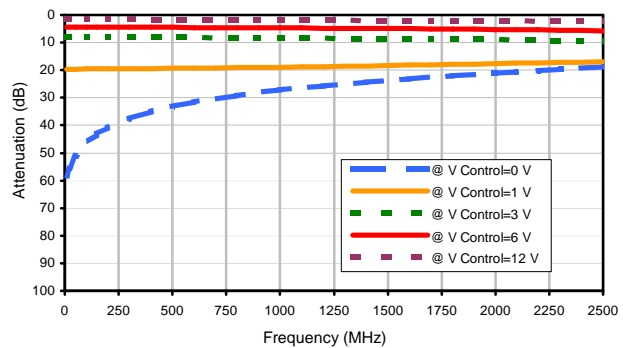

Input Return Loss @ V+=3 V

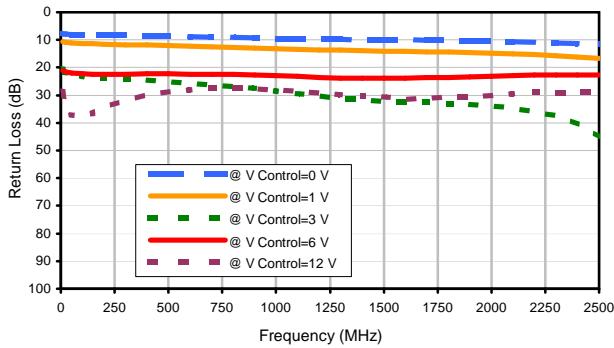

Input Return Loss @ V+=5 V

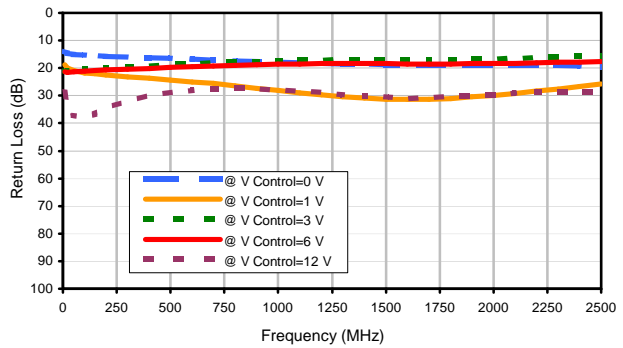

Output Return Loss @ V+=3 V

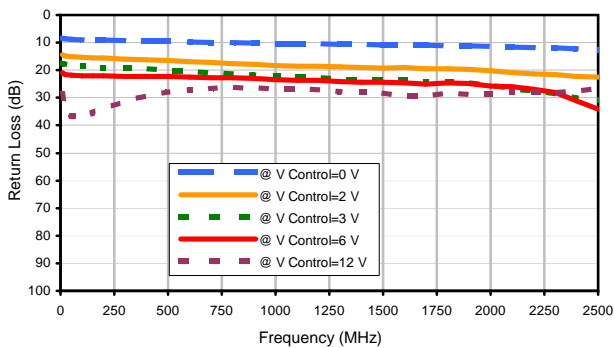

Output Return Loss @ V+=5 V

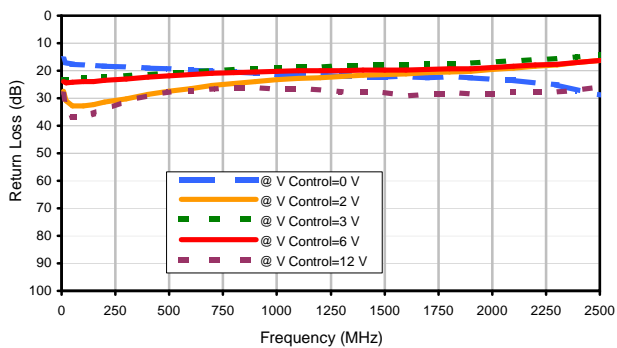

REV. X1  
MVA-2000+  
070704  
Page 1 of 2



IF/RF MICROWAVE COMPONENTS • ISO 9001 ISO 14001 AS 9100 CERTIFIED • RoHS compliant  
P.O. Box 350166, Brooklyn, New York 11235-0003 (718) 934-4500 Fax (718) 332-4661



The Design Engineers Search Engine finds the model you need, Instantly • For detailed performance specs & shopping online see



# Voltage Variable Attenuator

# MVA-2000+

## Typical Performance Curves

### Input IP3 @ V+=3 V

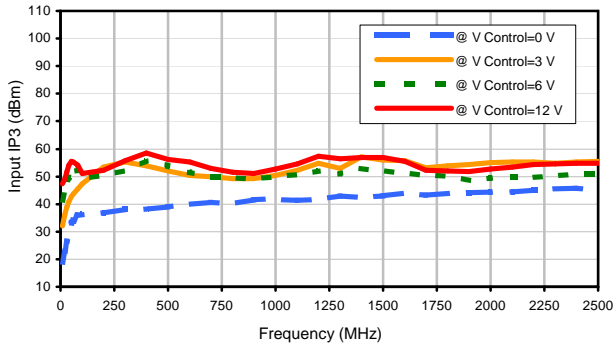

### Input IP3 @ V+=5 V

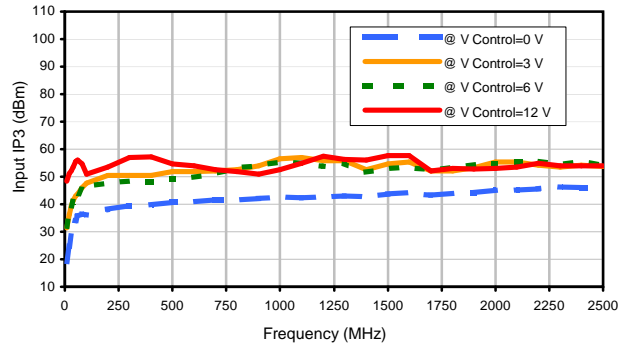

### Phase Shift @ V+=3 V

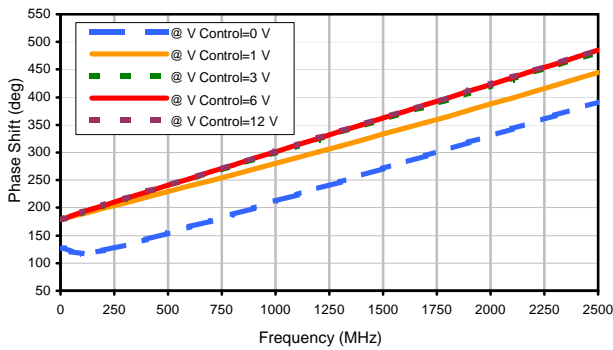

### Phase Shift @ V+=5 V

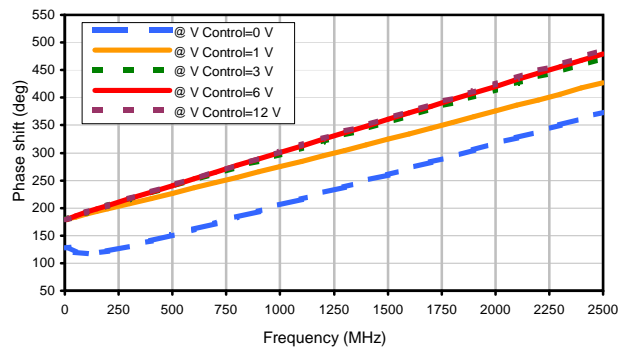

REV. X1  
MVA-2000+  
070704  
Page 2 of 2



IF/RF MICROWAVE COMPONENTS • ISO 9001 ISO 14001 AS 9100 CERTIFIED • RoHS compliant  
P.O. Box 350166, Brooklyn, New York 11235-0003 (718) 934-4500 Fax (718) 332-4661





The Design Engineers Search Engine finds the model you need, Instantly • For detailed performance specs & shopping online see

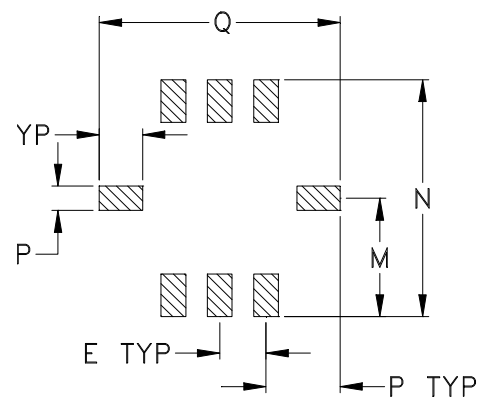
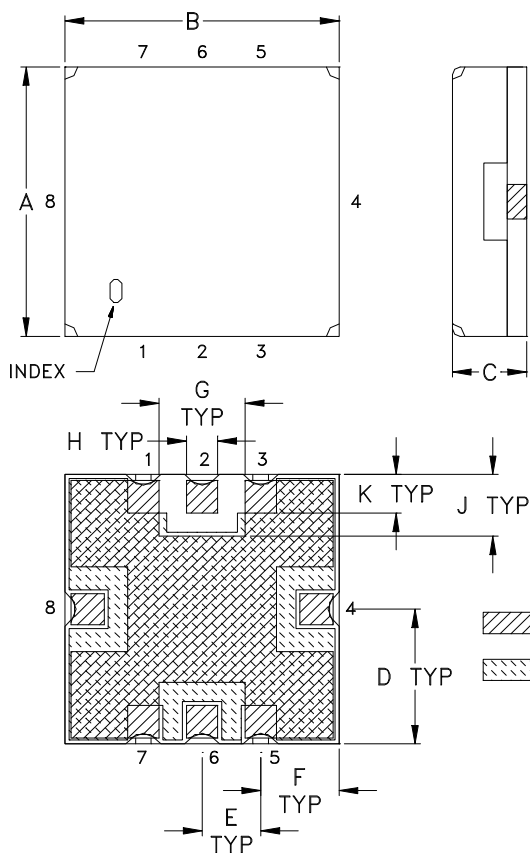

## Outline Dimensions

## GP731



 METALLIZATION  
 SOLDER RESIST

CASE #	A	B	C	D	E	F	G	H	J	K	L	M
GP731	.350 (8.89)	.350 (8.89)	.100 (2.54)	.175 (4.45)	.075 (1.91)	.100 (2.54)	.110 (2.79)	.040 (1.02)	.080 (2.03)	.050 (1.27)	.040 (1.02)	.195 (4.95)

CASE #	N	P	Q	R	WT. GRAM
GP731	.390 (9.91)	.120 (3.05)	.390 (9.91)	.070 (1.78)	.4 +0.3 -0.0

Dimensions are in inches (mm). Tolerances: 2 Pl.  $\pm .03$ ; 3Pl.  $\pm .015$

### Notes:

- Case material: Nickel-Silver alloy.
- Base: Printed wiring laminate.
- Termination finish:
  - For RoHS Case Styles: 3-5  $\mu$  inch (.08-.13 microns) Gold over 120-240  $\mu$  inch (3.05-6.10 microns) Nickel plate.
  - For RoHS-5 Case Styles: Tin-Lead plate.



P.O. Box 350166, Brooklyn, New York 11235-0003 (718) 934-4500 Fax (718) 332-4661 For detailed performance specs & shopping online see Mini-Circuits web site



The Design Engineers Search Engine Provides ACTUAL Data Instantly From MINI-CIRCUITS At: [www.minicircuits.com](http://www.minicircuits.com)

RF/IF MICROWAVE COMPONENTS

# Tape & Reel Packaging TR-F78

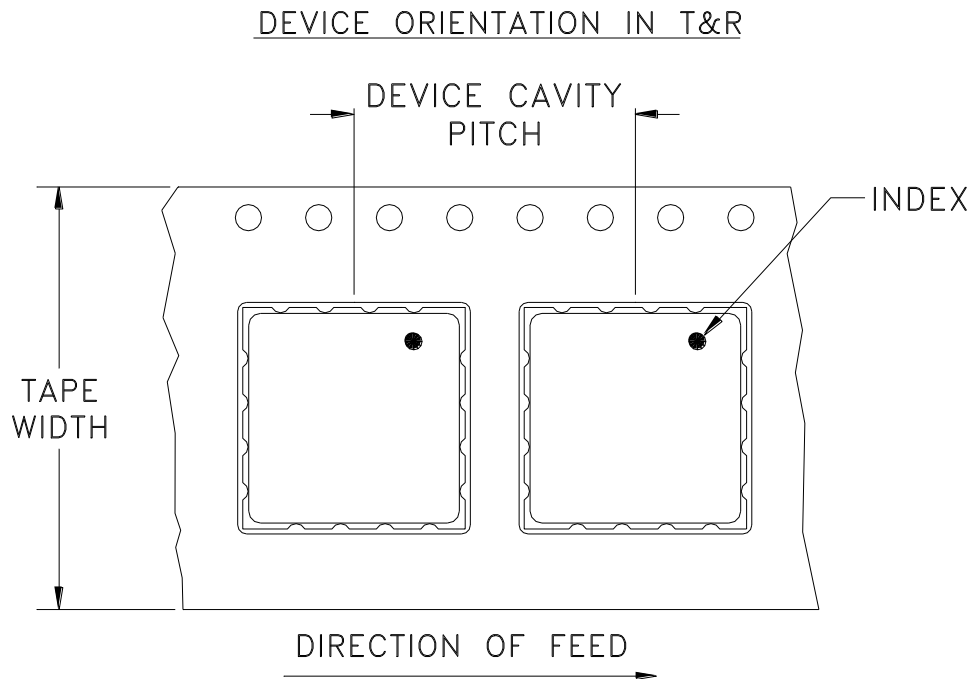

Tape Width, mm	Device Cavity Pitch, mm	Reel Size, inches	Devices per Reel see note
16	12	7	10
			20
			50
			100
			200
		13	500, 1000

Note: Please consult individual model data sheet to determine device per reel availability.

Mini-Circuits carrier tape materials provide protection from ESD (Electro-Static Discharge) during handling and transportation. Tapes are static dissipative and comply with industry standards EIA-481/EIA-541.

Go to: [www.minicircuits.com/pages/pdfs/tape.pdf](http://www.minicircuits.com/pages/pdfs/tape.pdf)



INTERNET <http://www.minicircuits.com>

P.O. Box 350166, Brooklyn, New York 11235-0003 (718) 934-4500 Fax (718) 332-4661

Distribution Centers NORTH AMERICA 800-654-7949 • 417-335-5935 • Fax 417-335-5945 • EUROPE 44-1252-832600 • Fax 44-1252-837010

Mini-Circuits ISO 9001 & ISO 14001 Certified

THIRD ANGLE PROJECTION

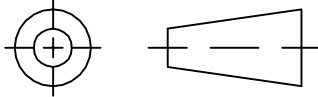

REVISIONS

REV	ECN No.	DESCRIPTION	DATE	DR	AUTH
OR	M91524	NEW RELEASE (FROM RAVON)	08/04	RZ	HH
OR	R56458	NEW RELEASE (FROM RAVON)	08/04	RZ	HH
A	M102713	ADDED "...WITH SMOBC"	01/12/06	GF	IL

**SUGGESTED MOUNTING CONFIGURATION  
FOR GP731 CASE STYLE, pk PIN CONNECTION.**

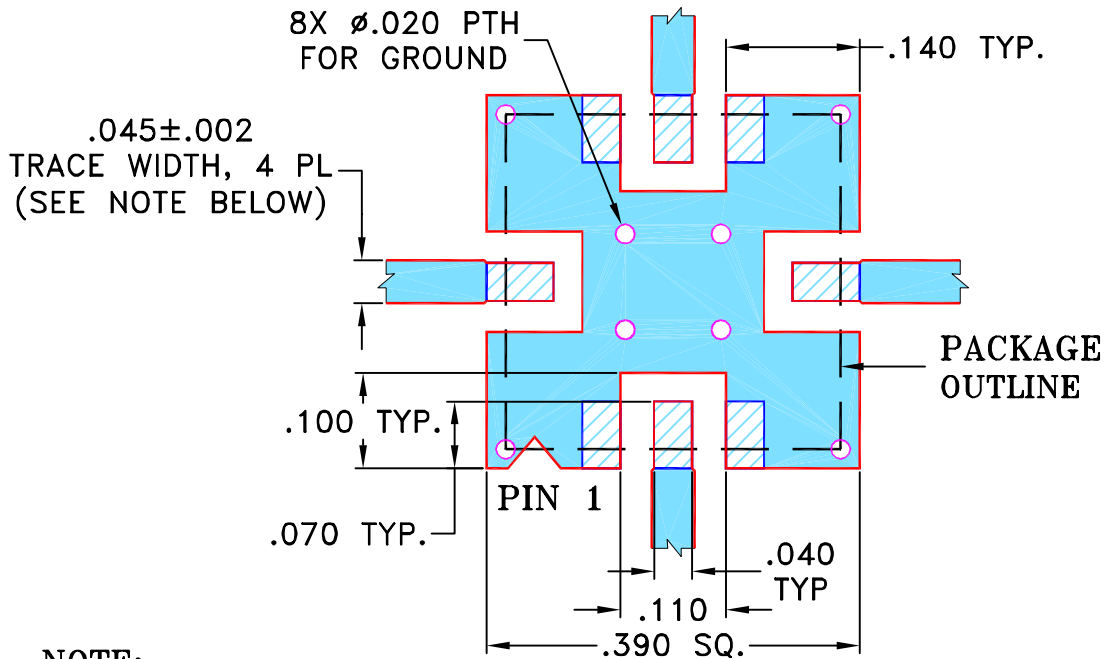

NOTE:

1. TRACE WIDTH IS SHOWN FOR FR4 WITH DIELECTRIC THICKNESS .025"±.002"; COPPER: 1/2 OZ. EACH SIDE.  
FOR OTHER MATERIALS TRACE WIDTH MAY NEED TO BE MODIFIED.
2. BOTTOM SIDE OF THE PCB IS CONTINUOUS GROUND PLANE.



DENOTES PCB COPPER LAYOUT WITH SMOBC (SOLDER MASK OVER BARE COPPER)



DENOTES COPPER LAND PATTERN FREE OF SOLDER MASK

UNLESS OTHERWISE SPECIFIED

INITIALS

DATE

DIMENSIONS ARE IN INCHES

DRAWN	RZ (RAVON)	26 AUG 04
-------	------------	-----------

TOLERANCES ON:

CHECKED	RZ (RAVON)	26 AUG 04
---------	------------	-----------

2 PL DECIMALS ±

APPROVED	HH (RAVON)	26 AUG 04
----------	------------	-----------

3 PL DECIMALS ± .005

ANGLES ±

FRACTIONS ±

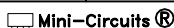

THIS DOCUMENT AND ITS CONTENTS ARE THE PROPERTY OF MINI-CIRCUITS. EXCEPT FOR USE EXPRESSLY GRANTED, IN WRITING, TO ITS VENDORS, VENDEE AND THE UNITED STATES GOVERNMENT, MINI-CIRCUITS RESERVES ALL PROPRIETARY DESIGN, USE, MANUFACTURING AND REPRODUCTION RIGHTS THERETO. THESE CONTENTS SHALL NOT BE USED, DUPLICATED OR DISCLOSED TO ANY OUTSIDE PARTY, IN WHOLE OR IN PART, WITHOUT WRITTEN PERMISSION OF MINI-CIRCUITS.

ASHEETA1.DWG REV:A DATE:01/12/95



**Mini-Circuits®**

13 Neptune Avenue  
Brooklyn NY 11235

**PL, pk, GP731, MVA, TB-286**

SIZE A	CODE IDENT 15542	DRAWING NO: 98-PL-154	REV: A
FILE: 98PL154	SCALE: 5:1	SHEET: 1 OF 1	

# Evaluation Board and Circuit

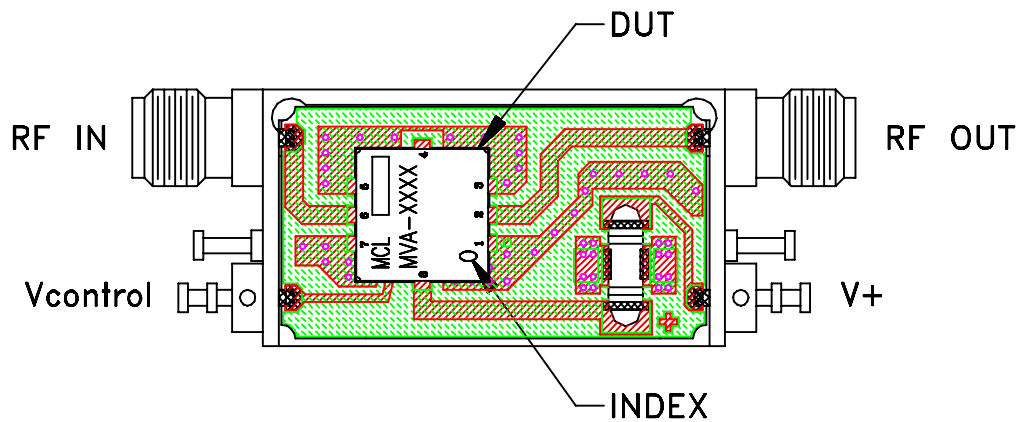

TB-286

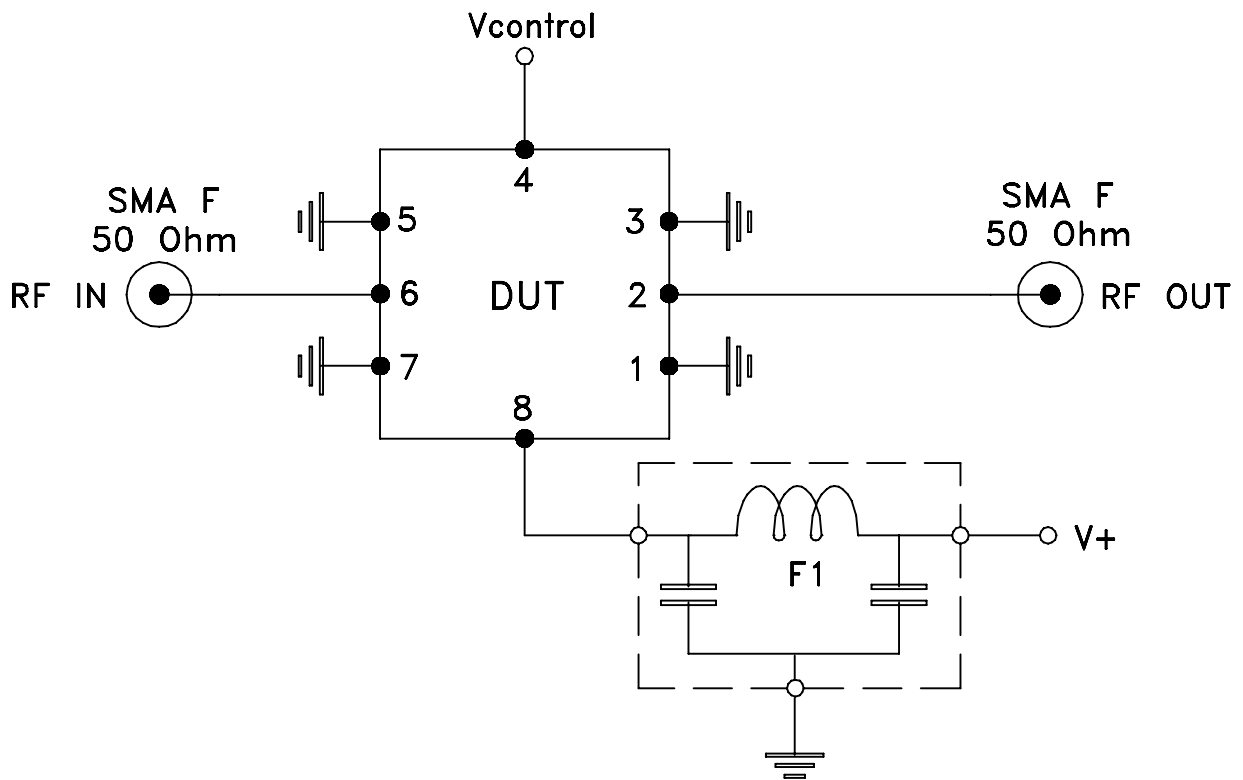

Schematic Diagram

## Notes:

1. SMA Female connectors.
2. PCB Material: FR4 GRADE IT-180TC (ITEQ CORPORATION)  
Dielectric Constant=4.5, Thickness=.025 inch.

 **Mini-Circuits®**

All Mini-Circuits products are manufactured under exacting quality assurance and control standards, and are capable of meeting published specifications after being subjected to any or all of the following physical and environmental test.

Specification	Test/Inspection Condition	Reference/Spec
Operating Temperature	-55° to 85°C Ambient Environment	Individual Model Data Sheet
Storage Temperature	-55° to 85° C Ambient Environment	Individual Model Data Sheet
HAST	130°C, 85% RH, 96 hours	JESD22-A110
Humidity	90 to 95% RH, 240 hours, 50°C	MIL-STD-202, Method 103, Condition A, Except 50°C and end-point electrical test done within 12 hours
Thermal Shock	-55° to 100°C, 100 cycles	MIL-STD-202, Method 107, Condition A-3, except +100°C
Solder Reflow Heat	Sn-Pb Eutectic Process: 225°C peak Pb-Free Process, 245°C peak	J-STD-020, Table 4-1, 4-2 and 5-2, Figure 5-1
Solderability	10X Magnification	J-STD-002, Para 4.2.5, Test S, 95% Coverage
Vibration (High Frequency)	20g peak, 20-2000 Hz, 4 times in each of three axes (total 12)	MIL-STD-883, Method 2007.3, Condition A
Mechanical Shock	50g, 11 ms, 1/2-sine, 18 shocks: 3 each direction, each of 3 axes	MIL-STD-202, Method 213, Condition A
Marking Resistance to Solvents	Isopropyl alcohol + mineral spirits at 25°C; terpene defluxer at 25°C; distilled water + proylene glycol monomethyl ether + monoethanolamine at 63°C to 70°C	MIL-STD-202, Method 215