

Xtra Long Life SPDT Switch

MSP2TA-18-12D+

50Ω DC to 18 GHz, 12 Volt, Absorptive

The Big Deal

- Extra long life - 10 million cycles
- Low insertion loss, 0.3 dB typ. at 18 GHz
- High isolation, 70 dB typ. at 18 GHz
- Absorptive
- Reliable sleep mode switching



CASE STYLE: FP914-3

Product Overview

Mini-Circuits' MSP2TA-18-12D+ is an ultra-reliable, rugged-duty absorptive fail-safe SP2T switch designed in break-before-make configuration offering an ultra long switching life. Powered by +12VDC, the device has a typical switching speed of 20 milliseconds, insertion loss of 0.3 dB and high isolation of 70 dB. The MSP2TA-18-12D+ is suitable for use across a wide range of applications, including switching for automated test equipment and redundancy switching.

Key Features

Feature	Advantages
Extra long service life	Exceptionally long service life improves system reliability and reduces the need to replace switches often.
High isolation, 70 dB typ.	Prevents interference from unwanted signals, ensuring signal integrity and accuracy of testing.
Reliable sleep-mode switching	Offers dependable performance even after being set at a fixed position for prolonged periods. Highly-reliable sleep mode switching averts failures due to "wake up," making it suitable for automatic testing as well as redundancy switching applications.
High repeatability between switching cycles	High repeatability of switching cycles ensures reliable performance critical for automated testing and other measurement applications.
15-Pin D-Sub Connector	Easy and reliable connect/disconnect eliminating soldering and connection errors.

Xtra Long Life SPDT Switch

50Ω DC to 18 GHz, 12 Volt, Absorptive

MSP2TA-18-12D+



front view

back view

CASE STYLE: FP914-3

Connectors Model
SMA MSP2TA-18-12-D+



Maximum Ratings

Operating Temperature	-15°C to +45°C
Storage Temperature	-15°C to +85°C
RF Power (any IN port)	20W
RF Power (any J1 and J2)	1W
Control Voltage	13VDC

Permanent damage may occur if any of these limits are exceeded.

Outline Drawing

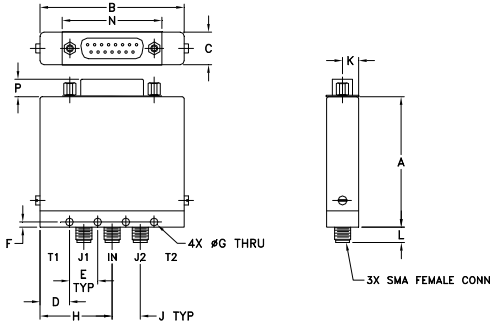

Outline Dimensions (inch/mm)

A	B	C	D	E	F	G	H	J	K	L	N	P	wt
2.00	2.25	.50	.460	.440	.080	.120	1.125	.440	.25	.24	1.55	.27	grams
50.80	57.15	12.70	11.68	11.18	2.03	3.05	28.58	11.18	6.35	6.10	39.37	6.86	98

CONTROL LOGIC

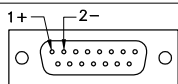

ON	OFF
T1-J1	J1-IN
IN-J2	J2-T2

ALL NOT BIASED PORTS ARE TERMINATED

Marking Drawing

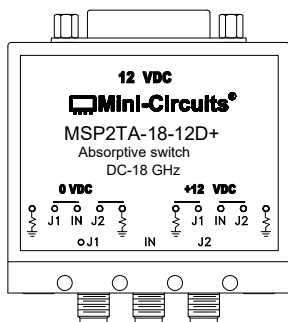

Features

- extra long switching life - 100 million cycles⁴
- low voltage operation, 12V
- low insertion loss, 0.3 dB typ. at 18 GHz
- high isolation, 70 dB typ. at 18 GHz
- high power handling, 20W
- ultra reliable
- break-before-make configuration
- absorptive failsafe switch
- protected by US Patents 5,272,458; 6,414,577; 6,650,210; 7,633,361; 7,843,289

Applications

- Automatic Test Equipment (ATE)
- redundancy switching for microwave radio

Electrical Specifications

Parameter	Condition	Min.	Typ. (Note 1)	Max.	Unit
Frequency Range		DC	—	18	GHz
Insertion Loss	DC - 1 GHz	—	0.10	0.15	dB
	1 - 8	—	0.15	0.30	
	8 - 12	—	0.25	0.40	
	12 - 18	—	0.30	0.50	
Isolation	DC - 1 GHz	85	100	—	dB
	1 - 8	75	90	—	
	8 - 12	70	80	—	
	12 - 18	60	70	—	
VSWR (Note 2)	DC - 1 GHz	—	1.05	1.10	:1
	1 - 8	—	1.20	1.30	
	8 - 12	—	1.20	1.35	
	12 - 18	—	1.15	1.40	
Operating Voltage Range	DC - 18 GHz		12±0.5		V
Control Signal (Note 3)	12V	—	350	430	mA
RF Power Cold Switching	—	—	—	20	W
RF Power Hot Switching	0.1W	10 million	—	—	Cycles
	1.0W	—	3 million	—	
Switching Time	DC - 18 GHz	—	20	—	ms

Notes

1. The performance values represents a common value for the frequency range. For typical performance across the frequency band, see performance graphs in the next page.
2. All ports, all states.
3. +12 Volt applied to energized port, COM is negative.
4. All units meet 10 million cycles and are capable of greater than 100 million cycles with factory cleaning.

Switching States

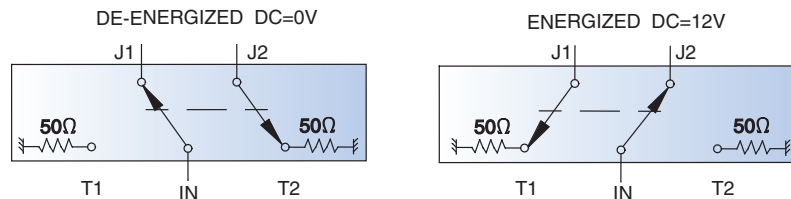

Typical Performance Data

FREQ. (MHz)	ON INSERTION LOSS (dB)		OFF ISOLATION (dB)		VSWR, IN (:1)		VSWR (J2) (:1)		VSWR (J1) (:1)	
	IN-J2	IN-J1	IN-J1	IN-J2	De- Energized	Energized	De- Energized	Energized	De- Energized	Energized
10.0	0.01	0.01	79.15	78.83	1.00	1.01	1.06	1.00	1.01	1.04
100.0	0.01	0.01	98.51	106.49	1.00	1.00	1.06	1.00	1.00	1.04
1000.0	0.04	0.04	121.18	105.44	1.01	1.01	1.05	1.01	1.01	1.04
2000.0	0.06	0.06	101.35	101.29	1.01	1.02	1.03	1.01	1.02	1.04
3000.0	0.07	0.07	104.33	102.22	1.04	1.05	1.01	1.04	1.04	1.03
4000.0	0.09	0.09	102.39	97.90	1.09	1.09	1.04	1.09	1.09	1.05
5000.0	0.11	0.12	108.21	98.20	1.15	1.14	1.09	1.15	1.14	1.10
6000.0	0.13	0.14	101.25	96.96	1.20	1.18	1.14	1.19	1.18	1.15
7000.0	0.14	0.15	98.22	99.67	1.20	1.19	1.17	1.20	1.19	1.18
8000.0	0.15	0.15	96.08	97.15	1.17	1.16	1.18	1.17	1.17	1.18
9000.0	0.14	0.15	94.61	105.59	1.11	1.12	1.16	1.11	1.12	1.15
10000.0	0.14	0.15	95.45	97.35	1.07	1.07	1.13	1.07	1.08	1.10
11000.0	0.15	0.16	90.97	96.67	1.05	1.06	1.10	1.06	1.06	1.08
12000.0	0.16	0.17	88.97	94.03	1.08	1.08	1.10	1.08	1.08	1.08
13000.0	0.18	0.20	89.02	87.71	1.15	1.13	1.12	1.14	1.13	1.10
14000.0	0.20	0.23	87.29	85.40	1.21	1.18	1.16	1.20	1.18	1.13
15000.0	0.22	0.26	84.63	83.93	1.23	1.20	1.20	1.22	1.20	1.17
16000.0	0.23	0.28	83.48	80.49	1.21	1.20	1.23	1.22	1.20	1.21
17000.0	0.23	0.29	80.95	79.21	1.16	1.17	1.22	1.20	1.17	1.21
18000.0	0.24	0.32	79.20	77.24	1.16	1.17	1.20	1.20	1.17	1.21

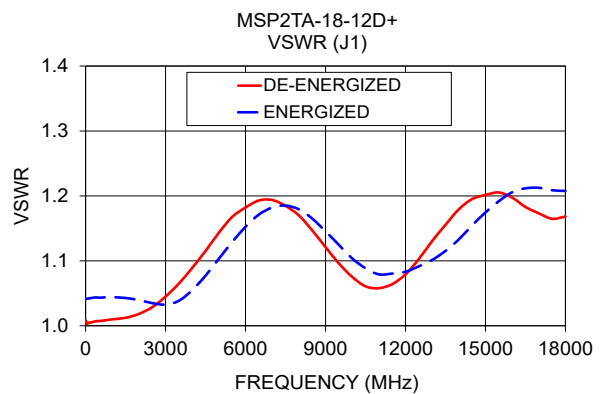
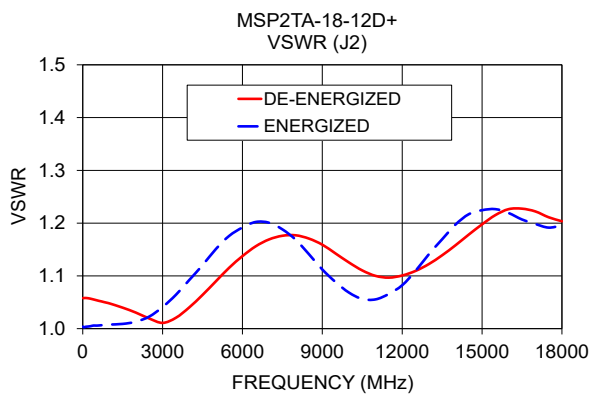
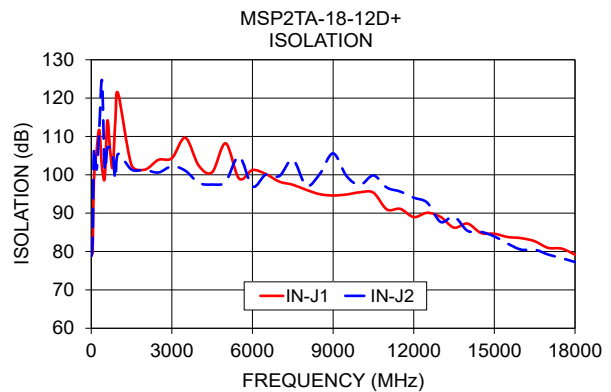
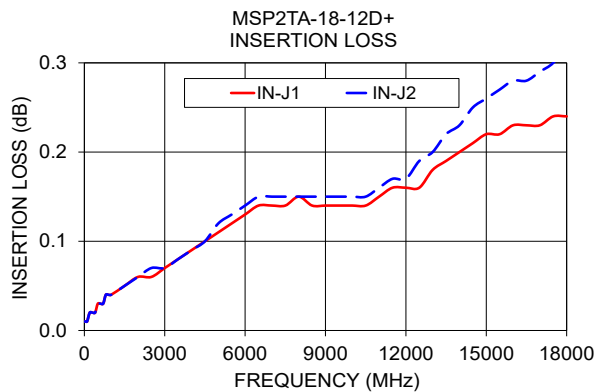

Additional Notes

- Performance and quality attributes and conditions not expressly stated in this specification document are intended to be excluded and do not form a part of this specification document.
- Electrical specifications and performance data contained in this specification document are based on Mini-Circuit's applicable established test performance criteria and measurement instructions.
- The parts covered by this specification document are subject to Mini-Circuits standard limited warranty and terms and conditions (collectively, "Standard Terms"); Purchasers of this part are entitled to the rights and benefits contained therein. For a full statement of the Standard Terms and the exclusive rights and remedies thereunder, please visit Mini-Circuits' website at www.minicircuits.com/MCLStore/terms.jsp

SPDT Switch

MSP2TA-18-12D+

Typical Performance Data

FREQUENCY (MHz)	INSERTION LOSS ON (dB)		ISOLATION OFF (dB)		VSWR, IN (:1)		VSWR ENERGIZED (:1)		VSWR DE-ENERGIZED (:1)	
	IN-J1	IN-J2	IN-J1	IN-J2	ON	OFF	T1	J2	J1	T2
10	0.01	0.01	79.15	78.83	1.00	1.01	1.06	1.00	1.01	1.04
50	0.01	0.01	79.67	82.79	1.00	1.00	1.06	1.00	1.00	1.04
100	0.01	0.01	98.51	106.49	1.00	1.00	1.06	1.00	1.00	1.04
200	0.02	0.02	106.20	101.41	1.00	1.00	1.06	1.00	1.01	1.04
300	0.02	0.02	111.63	111.99	1.00	1.01	1.06	1.00	1.01	1.04
400	0.02	0.02	102.03	124.56	1.01	1.01	1.06	1.01	1.01	1.04
500	0.03	0.03	98.95	101.72	1.01	1.01	1.05	1.01	1.01	1.04
600	0.03	0.03	114.04	107.11	1.01	1.01	1.05	1.01	1.01	1.04
700	0.03	0.03	106.61	107.06	1.01	1.01	1.05	1.01	1.01	1.04
800	0.04	0.04	101.96	105.09	1.01	1.01	1.05	1.01	1.01	1.04
900	0.04	0.04	114.40	98.98	1.01	1.01	1.05	1.01	1.01	1.04
1000	0.04	0.04	121.18	105.44	1.01	1.01	1.05	1.01	1.01	1.04
1500	0.05	0.05	102.50	101.36	1.01	1.02	1.04	1.01	1.01	1.04
2000	0.06	0.06	101.35	101.29	1.01	1.02	1.03	1.01	1.02	1.04
2500	0.06	0.07	103.90	100.60	1.02	1.03	1.02	1.02	1.03	1.03
3000	0.07	0.07	104.33	102.22	1.04	1.05	1.01	1.04	1.04	1.03
3500	0.08	0.08	109.66	101.07	1.06	1.07	1.02	1.06	1.07	1.04
4000	0.09	0.09	102.39	97.90	1.09	1.09	1.04	1.09	1.09	1.05
4500	0.10	0.10	100.67	97.47	1.12	1.12	1.06	1.12	1.12	1.08
5000	0.11	0.12	108.21	98.20	1.15	1.14	1.09	1.15	1.14	1.10
5500	0.12	0.13	99.02	104.80	1.18	1.17	1.12	1.18	1.17	1.13
6000	0.13	0.14	101.25	96.96	1.20	1.18	1.14	1.19	1.18	1.15
6500	0.14	0.15	100.19	100.10	1.21	1.19	1.16	1.20	1.19	1.17
7000	0.14	0.15	98.22	99.67	1.20	1.19	1.17	1.20	1.19	1.18
7500	0.14	0.15	97.41	103.94	1.19	1.18	1.18	1.19	1.18	1.19
8000	0.15	0.15	96.08	97.15	1.17	1.16	1.18	1.17	1.17	1.18
8500	0.14	0.15	94.95	100.17	1.14	1.14	1.17	1.14	1.15	1.17
9000	0.14	0.15	94.61	105.59	1.11	1.12	1.16	1.11	1.12	1.15
9500	0.14	0.15	94.87	99.67	1.09	1.09	1.14	1.09	1.10	1.12
10000	0.14	0.15	95.45	97.35	1.07	1.07	1.13	1.07	1.08	1.10
10500	0.14	0.15	95.34	99.84	1.06	1.06	1.11	1.06	1.06	1.09
11000	0.15	0.16	90.97	96.67	1.05	1.06	1.10	1.06	1.06	1.08
11500	0.16	0.17	91.12	95.63	1.06	1.06	1.10	1.07	1.06	1.08
12000	0.16	0.17	88.97	94.03	1.08	1.08	1.10	1.08	1.08	1.08
12500	0.16	0.19	90.09	92.75	1.11	1.10	1.11	1.11	1.10	1.09
13000	0.18	0.20	89.02	87.71	1.15	1.13	1.12	1.14	1.13	1.10
13500	0.19	0.22	86.22	89.12	1.18	1.16	1.14	1.17	1.16	1.12
14000	0.20	0.23	87.29	85.40	1.21	1.18	1.16	1.20	1.18	1.13
14500	0.21	0.25	84.83	85.14	1.23	1.20	1.18	1.22	1.20	1.15
15000	0.22	0.26	84.63	83.93	1.23	1.20	1.20	1.22	1.20	1.17
15500	0.22	0.27	83.78	82.04	1.23	1.21	1.22	1.23	1.21	1.19
16000	0.23	0.28	83.48	80.49	1.21	1.20	1.23	1.22	1.20	1.21
16500	0.23	0.28	82.68	80.51	1.18	1.19	1.23	1.21	1.18	1.21
17000	0.23	0.29	80.95	79.21	1.16	1.17	1.22	1.20	1.17	1.21
17500	0.24	0.30	80.77	78.30	1.15	1.17	1.21	1.19	1.16	1.21
18000	0.24	0.32	79.20	77.24	1.16	1.17	1.20	1.20	1.17	1.21



P.O. Box 350166, Brooklyn, New York 11235-0003 (718) 934-4500 • Fax (718) 332-4661 For detailed performance specs & shopping online see Mini-Circuits web site



The Design Engineers Search Engine Provides ACTUAL Data Instantly From MINI-CIRCUITS At: www.minicircuits.com

IF/RF MICROWAVE COMPONENTS

REV. OR

MSP2TA-18-12D+

11/15/2018

Page 1 of 1

Typical Performance Curves

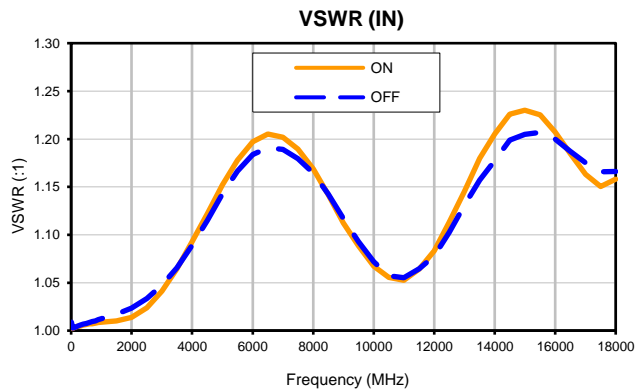
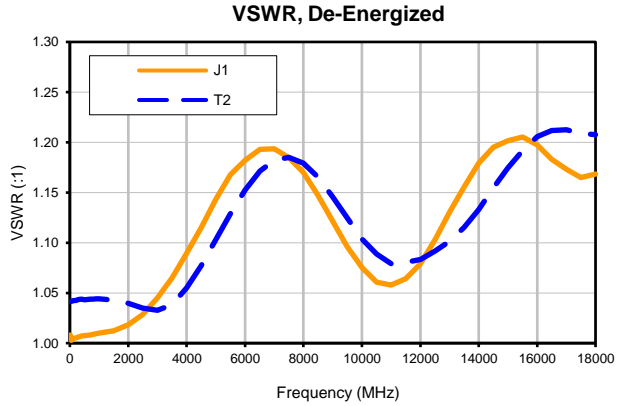
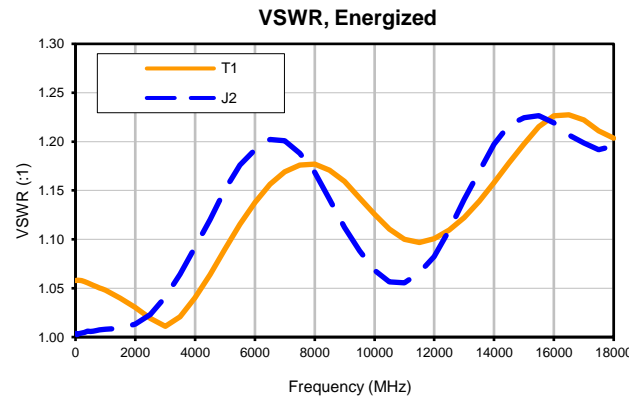
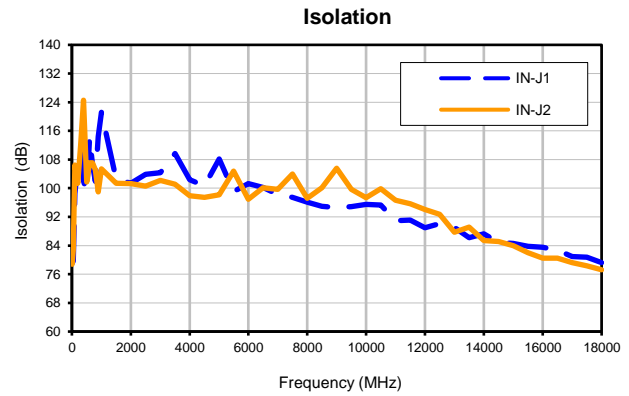
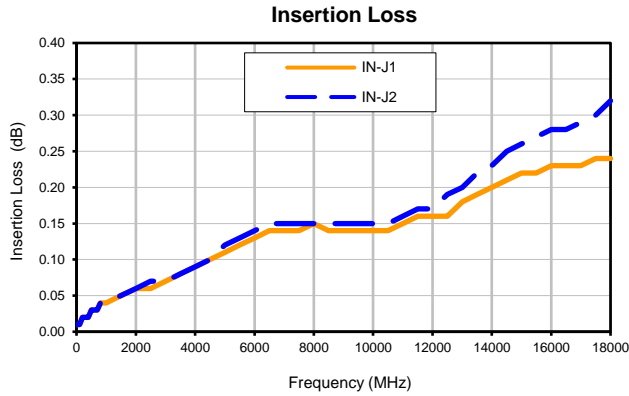

Case Style

FP

Outline Dimensions

FP914-3

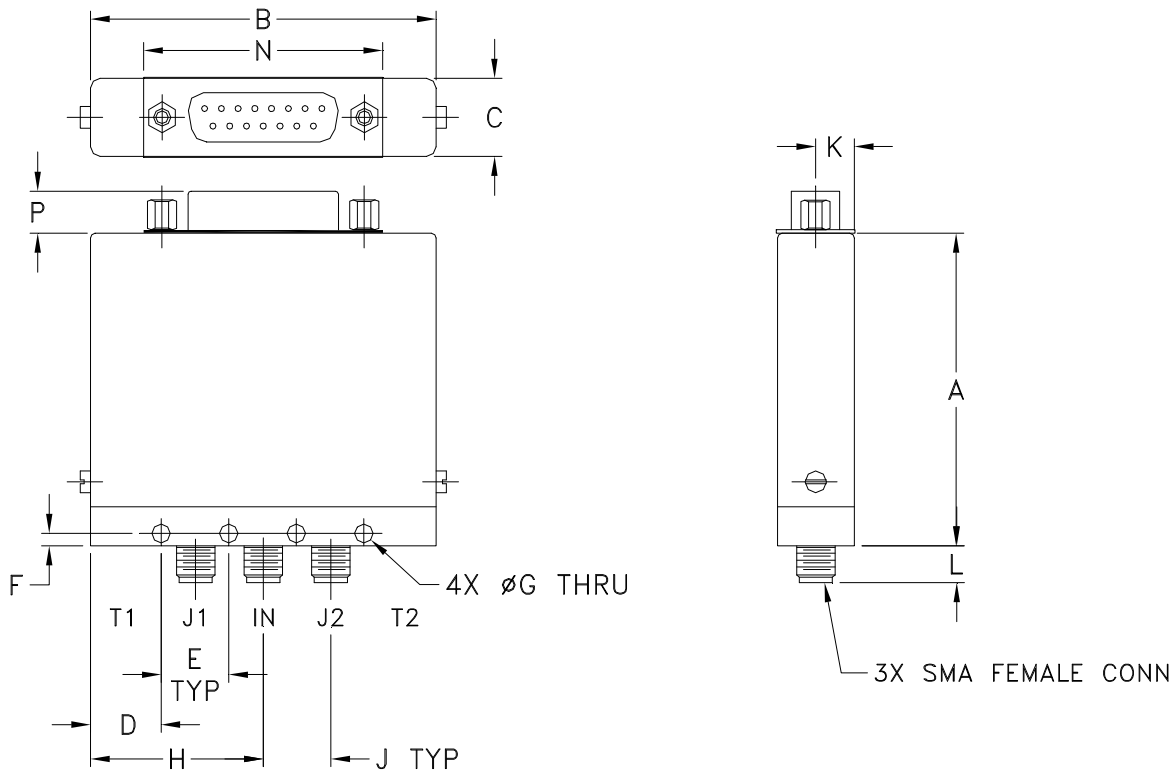

CASE #.	A	B	C	D	E	F	G	H	J	K	L	M	N
FP914-3	2.00 (50.80)	2.25 (57.15)	.50 (12.70)	.460 (11.68)	.440 (11.18)	.080 (2.03)	.120 (3.05)	1.125 (28.58)	.440 (11.18)	.25 (6.35)	.24 (6.10)	--	1.55 (39.37)

CASE #.	P	WT, GRAM
FP914-3	.27 (6.86)	98

Dimensions are in inches (mm). Tolerances: 2Pl. $\pm .03$; 3Pl. $\pm .015$

Note:

- Case material: Copper-Nickel alloy.

Mini-Circuits[®]

INTERNET <http://www.minicircuits.com>

P.O. Box 350166, Brooklyn, New York 11235-0003 (718) 934-4500 Fax (718) 332-4661

Distribution Centers NORTH AMERICA 800-654-7949 • 417-335-5935 • Fax 417-335-5945 • EUROPE 44-1252-832600 • Fax 44-1252-837010

Mini-Circuits ISO 9001 & ISO 14001 Certified

All Mini-Circuits products are manufactured under exacting quality assurance and control standards, and are capable of meeting published specifications after being subjected to any or all of the following physical and environmental test.

Specification	Test/Inspection Condition	Reference/Spec
Operating Temperature	-15° to 45°C Ambient Environment	Individual Model Data Sheet
Storage Temperature	-15° to 85°C Ambient Environment	Individual Model Data Sheet
Humidity	90 to 95% RH, 96 hours, 40°C	MIL-STD-202, Method 103B, Condition B, Except 50°C
Thermal Shock	-55° to 100°C, 50 cycles	MIL-STD-202, Method 107, Condition B, except -55° to +100°C and 50 cycles
Vibration (High Frequency)	0.06-inch double amplitude, 10-55 Hz, 2 hours in each of three perpendicular directions (total 6 hours)	MIL-STD-202, Method 204, Condition C, Part 1
Mechanical Shock	50G, 11 ms sawtooth, 18 shocks: 3 each direction, each of 3 axes	MIL-STD-202, Method 213, Condition G
Marking Resistance to Solvents	Isopropyl alcohol + mineral spirits at 25°C; terpene defluxer at 25°C; distilled water + proylene glycol monomethyl ether + monoethanolamine at 63°C to 70°C	MIL-STD-202, Method 215