



HIGH DIRECTIVITY

Monolithic Amplifier

MNA-7A+

50Ω 1.5 to 6.0 GHz

THE BIG DEAL

- Integrated matching, DC Blocks and bias circuits
- Excellent Active Directivity, 18-38 dB typ.
- Choice of supply voltage, 2.8V to 5V
- Micro-miniature size .120"X.120"
- Output power, up to +17.4 dBm typ.
- Aqueous washable

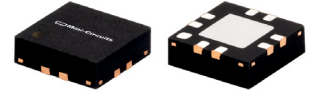

Generic photo used for illustration purposes only

CASE STYLE: DQ849

+RoHS Compliant

The +Suffix identifies RoHS Compliance. See our website for methodologies and qualifications

APPLICATIONS

- Buffer amplifier
- Cellular
- PCN
- Communications satellite
- Defense

PRODUCT OVERVIEW

MNA-7A+ is a wideband PHEMT based MMIC amplifier with high active Directivity. MNA integrates the entire matching network and majority of the bias circuit inside the package, reducing the need for complicated external circuits. This approach makes the MNA amplifier extremely straightforward to use. This design operates on a single 2.8 to 5V supply, is well matched for 50Ω and comes in a tiny, low profile 3x3mm 8-lead MCLP package accommodating dense circuit board layouts. [MNA-7A+ belongs to MNA series of models available in Die and packaged form.](#)

KEY FEATURES

Feature	Advantages
Excellent Active Directivity (Isolation- Gain) 18-38 dB	Ideal for use as a buffer amplifier minimizing interaction of adjacent circuits
Integrates DC blocks and RF choke	Minimizes external components, component count and circuit area.
Single 2.8 to +5V operation	Amplifier can be used at low voltage such as +3V or standard +5V. +5V operation results in higher P1dB and OIP3.
3 x 3mm 8-lead MCLP package	Tiny footprint saves space in dense layouts while providing low inductance, repeatable transitions, and excellent thermal contact to the PCB.

REV. A
ECO-011187
MNA-7A+
MCL NY
220928





HIGH DIRECTIVITY

Monolithic Amplifier

MNA-7A+

ELECTRICAL SPECIFICATIONS¹ AT 25°C

Parameter	Condition (GHz)	Vs=5V			Vs=2.8V Typ.	Units
		Min.	Typ.	Max.		
Frequency Range		1.5		6.0	1.5-6.0	GHz
Gain	1.5	—	17.5	—	15.0	dB
	2.0	16.3	17.7	19.9	15.6	
	3.5	—	17.7	—	15.7	
	5.0	—	18.0	—	16.7	
	5.9	—	12.6	—	9.2	
	6.0	—	11.7	—	8.1	
Input Return Loss	1.5		7.5		7.5	dB
	2.0		11.0		10.5	
	3.5		17.4		15.9	
	5.0		15.5		15.5	
	5.9		11.2		10.1	
	6.0		11.1		10.2	
Output Return Loss	1.5		18.7		18.7	dB
	2.0		21.6		16.6	
	3.5		21.3		13.7	
	5.0		15.8		12.2	
	5.9		14.3		9.9	
	6.0		13.5		9.5	
Output Power at P1dB	1.5		17.4		12.4	dBm
	2.0		17.1		13.0	
	3.5		14.8		11.9	
	5.0		16.1		13.4	
	5.9		15.6		10.9	
	6.0		14.4		9.7	
Output IP3	1.5		28.8		23.7	dBm
	2.0		28.5		24.3	
	3.5		25.8		22.6	
	5.0		27.4		24.5	
	5.9		27.0		21.7	
	6.0		25.6		20.3	
Noise Figure (dB)	1.5		6.9		7.3	dB
	2.0		5.7		6.2	
	3.5		4.3		4.8	
	5.0		3.7		4.0	
	5.9		4.5		5.2	
	6.0		4.7		5.4	
Active Directivity (Isolation-Gain)	1.5		32.4		35.1	dB
	2.0		27.2		29.2	
	3.5		20.6		22.6	
	5.0		19.4		18.9	
	5.9		23.5		25.9	
	6.0		24.5		27.1	
DC Current			82	103	77	mA
Device Current Variation vs. Temperature ²			31		21	µA/°C
Device Current Variation vs Voltage			0.0009 ³		0.003 ⁴	mA/mV
Thermal resistance at 85°C (Junction to Lead)			60		60	°C/W

1. Measured on Mini-Circuits Characterization test board TB-186-7A+. See Characterization Test Circuit (Fig. 1)

2. (Current at 85°C - Current at -45°C)/130

3. (Current at 5.25V - Current at 3.9V)/1.35

4. (Current at 3.9V - Current at 2.66V)/1.24





HIGH DIRECTIVITY

Monolithic Amplifier

MNA-7A+

MAXIMUM RATINGS⁵

Parameter	Ratings
Operating Temperature	-40°C to 85°C
Storage Temperature	-55°C to 100°C
DC Voltage	7V at pin 7 (on TB-186-7A+) 1V at pins 2 & 5
Power Dissipation	750 mW
Input Power	10 dBm (continuous operation) 26 dBm over 1.5 to 3.7 GHz (5 minutes max) 20 dBm over 3.7 to 6 GHz (5 minutes max)

⁵Permanent damage may occur if any of these limits are exceeded. These ratings are not intended for continuous normal operation.

SIMPLIFIED SCHEMATIC AND PAD DESCRIPTION

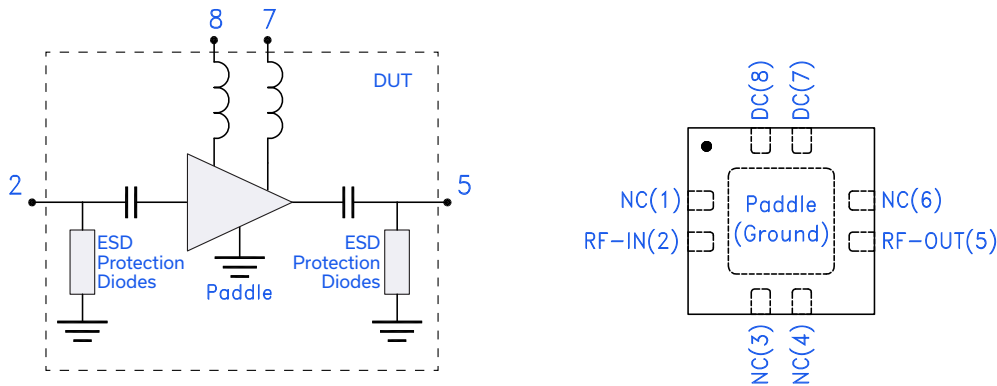

Function	Pad Number	Description (See Fig 1)
RF-IN	2	RF input pin
RF-OUT	5	RF output pin
DC	7,8	DC Bias pads 7,8. Pad 7 connected to ground via 1000 pF. Pad 8 connected to pad 7 via 6.81 ohms
NC	1,3,4,6	Not Connected, connect pad 3 and 4 to ground externally
GND	Paddle	Paddle in center of bottom
OPTIONAL	1,3,4,6	No internal connection; recommended use: per PCB Layout PL-078



CHARACTERIZATION & APPLICATION TEST CIRCUIT

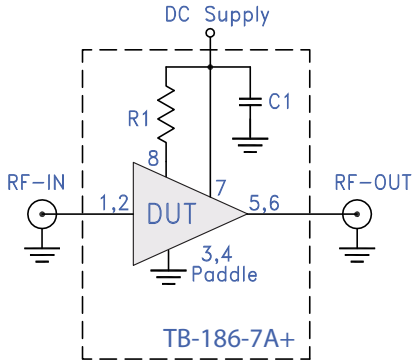

Fig 1. Block Diagram of Test Circuit used for characterization. (DUT soldered on Mini-Circuits Characterization test board TB-313)
Gain, Return loss, Output power at 1dB compression (P1 dB) , output IP3 (OIP3) and noise figure measured using Agilent's N5242A PNA-X microwave network analyzer.

Conditions:

1. Gain and Return loss: Pin= -25dBm
2. Output IP3 (OIP3): Two tones, spaced 1 MHz apart, 0 dBm/tone at output.

Component	Size	Value	Units
R1	0805	6.81	Ω
C1	0402	1000	pF

RECOMMENDED APPLICATION CIRCUIT

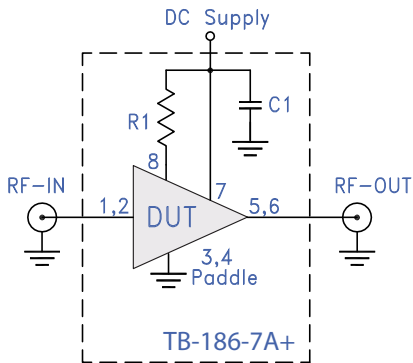
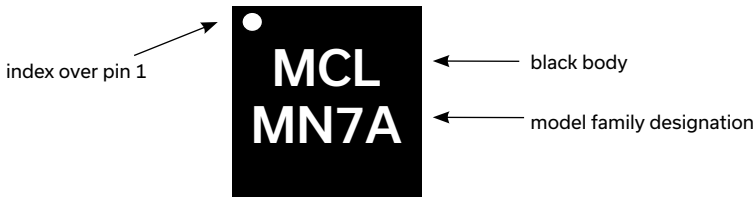

Fig 2. Test Board includes case, connectors, and components soldered to PCB

Component	Size	Value	Units
R1	0805	33.2	Ω
C1	0402	1000	p F

PRODUCT MARKING



Marking may contain other features or characters for internal lot control



HIGH DIRECTIVITY

Monolithic Amplifier

MNA-7A+

ADDITIONAL DETAILED TECHNICAL INFORMATION IS AVAILABLE ON OUR DASH BOARD. TO ACCESS [CLICK HERE](#)

Performance Data	Data Table Swept Graphs S-Parameter (S2P Files) Data Set (.zip file)
Case Style	DQ849 3x3x0.9 mm MCLP Plastic package, exposed paddle lead finish: Matte-Tin
Tape & Reel Standard quantities available on reel	F104 7" reels with 20, 50, 100, 200, 500, 1K, or 2K devices
Suggested Layout for PCB Design	PL-078
Evaluation Board	TB-186-7W+
Environmental Ratings	ENV08T1

ESD RATING

Human Body Model (HBM): Class 1A (250 to <500V) in accordance with ANSI/ESD STM 5.1 - 2001

MSL RATING

Moisture Sensitivity: MSL1 in accordance with IPC/JEDEC J-STD-020D

MSL TEST FLOW CHART

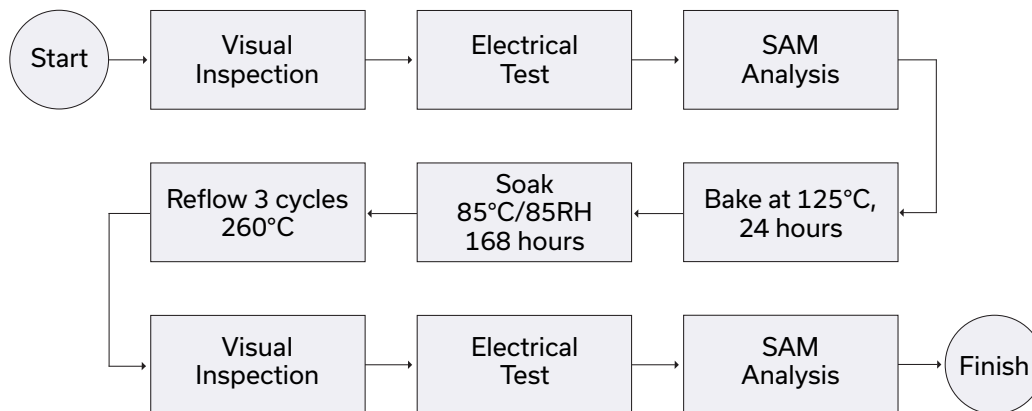

- NOTES**
- A. Performance and quality attributes and conditions not expressly stated in this specification document are intended to be excluded and do not form a part of this specification document.
 - B. Electrical specifications and performance data contained in this specification document are based on Mini-Circuit's applicable established test performance criteria and measurement instructions.
 - C. The parts covered by this specification document are subject to Mini-Circuits standard limited warranty and terms and conditions (collectively, "Standard Terms"); Purchasers of this part are entitled to the rights and benefits contained therein. For a full statement of the standard. Terms and the exclusive rights and remedies thereunder, please visit Mini-Circuits' website at www.minicircuits.com/MCLStore/terms.jsp



Typical Performance Data

NOTE: Use PDF Bookmarks to view DATA at required conditions

Definitions:

Input Return Loss = -S11 (dB)

Gain(Power Gain) = S21 (dB)

Reverse Isolation = -S12 (dB)

Output Return Loss = -S22 (dB)

TEST CONDITIONS: Vd = 5.00V, Id = 77.15mA @ Temperature = +25°C

FREQ	Gain	Isolation	Input Return Loss	Output Return Loss	Stability		IP-3 Output	1dB Comp. Output	Noise Figure
					K	Measure			
(MHz)	(dB)	(dB)	(dB)	(dB)			(dBm)	(dBm)	(dB)
1000	15.33	73.97	3.95	19.34	252.13	1.39	25.44	13.59	8.56
1100	16.33	73.62	4.57	22.35	236.87	1.34	27.22	15.36	8.03
1200	17.06	62.37	5.29	26.47	64.71	1.29	28.38	16.41	7.53
1300	17.59	57.23	6.04	31.74	36.01	1.25	29.00	16.89	7.09
1400	17.94	54.27	6.80	37.33	25.91	1.21	28.90	17.13	6.80
1500	18.18	52.16	7.56	38.24	20.63	1.17	28.78	17.04	6.47
1600	18.29	50.24	8.35	35.58	16.91	1.14	28.67	16.84	6.23
1700	18.35	49.01	9.11	33.11	14.98	1.12	28.59	16.98	6.03
1800	18.35	47.83	9.90	31.99	13.38	1.10	28.76	16.89	5.79
1900	18.33	46.68	10.65	30.87	11.97	1.08	28.71	16.94	5.64
2000	18.29	46.02	11.30	29.71	11.28	1.07	28.31	16.81	5.45
2100	18.25	45.36	12.01	29.22	10.64	1.06	28.03	16.46	5.31
2200	18.18	44.77	12.73	28.56	10.11	1.05	27.65	16.30	5.13
2300	18.14	44.14	13.44	27.41	9.53	1.04	27.60	16.37	5.04
2400	18.16	43.73	14.15	26.67	9.13	1.03	27.35	16.24	4.86
2500	18.10	43.42	14.84	25.98	8.92	1.03	27.12	16.02	4.79
2600	18.12	43.03	15.62	25.16	8.56	1.02	26.91	15.78	4.77
2700	18.13	42.96	16.55	24.70	8.51	1.02	26.70	15.58	4.69
2800	18.17	42.39	17.18	24.13	7.97	1.01	26.42	15.28	4.68
2900	18.22	41.66	17.76	23.54	7.30	1.01	26.24	15.11	4.64
3000	18.28	41.22	18.40	23.21	6.91	1.01	25.81	14.77	4.46
3100	18.32	40.98	18.96	23.34	6.70	1.00	25.68	14.67	4.39
3300	18.46	40.55	19.88	23.49	6.30	1.00	25.18	14.34	4.33
3500	18.61	39.89	20.03	22.61	5.74	1.00	25.18	14.26	4.14
3700	18.89	39.42	19.45	22.55	5.27	1.00	24.95	13.97	4.04
3900	19.22	39.09	18.81	22.12	4.88	1.00	24.75	13.77	3.94
4100	19.52	39.81	18.68	20.45	5.09	1.00	24.50	13.58	3.81
4300	19.87	39.35	18.96	20.66	4.65	0.99	24.45	13.68	3.72
4500	19.70	40.63	19.69	19.17	5.48	0.99	25.20	14.26	3.74
4700	19.51	40.08	18.35	19.80	5.24	1.00	25.82	14.57	3.65
4900	19.19	39.32	17.01	21.70	4.98	1.01	27.09	15.90	3.62
5100	18.59	38.56	15.64	25.81	4.87	1.02	28.45	16.29	3.73
5300	18.05	38.91	13.91	28.82	5.34	1.03	28.75	16.97	3.72
5500	17.17	38.00	13.30	22.91	5.28	1.03	28.97	17.39	3.84
5700	15.72	38.19	12.54	18.59	6.25	1.03	28.12	16.86	4.05
5900	13.96	38.04	12.32	14.98	7.36	1.02	26.46	15.17	4.32
6100	12.12	36.39	11.86	13.47	7.38	1.01	24.23	12.69	4.75
6300	9.95	37.69	12.17	12.02	10.81	0.99	21.21	9.83	5.36
6500	7.64	38.00	12.70	10.93	14.39	0.96	17.47	7.03	6.04

Typical Performance Data

Definitions:

Input Return Loss = -S11 (dB)

Gain(Power Gain) = S21 (dB)

Reverse Isolation = -S12 (dB)

Output Return Loss = -S22 (dB)

TEST CONDITIONS: Vd = 3.90V, Id = 76.12mA @ Temperature = +25°C

FREQ	Gain	Isolation	Input Return Loss	Output Return Loss	Stability		IP-3 Output	1dB Comp. Output	Noise Figure
					K	Measure			
(MHz)	(dB)	(dB)	(dB)	(dB)	K	Measure	(dBm)	(dBm)	(dB)
1000	14.51	75.72	4.02	18.90	342.73	1.38	24.45	12.68	8.63
1100	15.44	68.86	4.64	21.67	152.95	1.33	25.99	14.35	8.13
1200	16.14	60.42	5.35	25.35	57.83	1.29	27.11	15.43	7.67
1300	16.65	56.23	6.07	29.42	35.83	1.25	27.57	15.94	7.22
1400	17.02	53.61	6.80	32.00	26.73	1.21	27.61	16.17	6.93
1500	17.28	51.62	7.53	31.18	21.48	1.17	27.50	16.17	6.60
1600	17.42	49.79	8.28	29.01	17.68	1.15	27.53	16.08	6.40
1700	17.52	48.57	9.00	27.03	15.59	1.12	27.38	16.13	6.20
1800	17.55	47.37	9.74	25.82	13.85	1.10	27.64	16.09	5.96
1900	17.56	46.22	10.44	24.78	12.32	1.08	27.62	16.14	5.79
2000	17.55	45.53	11.04	23.87	11.53	1.07	27.34	15.98	5.64
2100	17.53	44.86	11.70	23.43	10.82	1.06	27.13	15.80	5.44
2200	17.48	44.23	12.37	23.11	10.22	1.05	26.74	15.68	5.34
2300	17.45	43.57	13.00	22.61	9.58	1.04	26.60	15.57	5.20
2400	17.48	43.13	13.63	22.33	9.14	1.03	26.29	15.42	5.04
2500	17.43	42.80	14.24	22.09	8.90	1.03	26.21	15.32	4.96
2600	17.44	42.38	14.93	21.78	8.52	1.02	25.91	14.97	4.93
2700	17.45	42.25	15.72	21.78	8.42	1.02	25.78	14.88	4.86
2800	17.48	41.69	16.24	21.42	7.89	1.01	25.62	14.58	4.85
2900	17.52	40.96	16.71	20.98	7.24	1.01	25.36	14.48	4.82
3000	17.57	40.55	17.23	20.79	6.88	1.01	25.11	14.20	4.61
3100	17.59	40.34	17.72	20.86	6.72	1.00	24.94	14.09	4.52
3300	17.69	39.98	18.55	21.09	6.39	1.00	24.56	13.79	4.47
3500	17.81	39.34	18.74	20.09	5.86	1.00	24.33	13.72	4.29
3700	18.07	38.97	18.47	19.44	5.44	1.00	24.17	13.39	4.19
3900	18.40	38.68	18.15	18.32	5.05	0.99	23.97	13.15	4.09
4100	18.71	39.39	18.29	16.49	5.25	0.99	23.92	13.03	3.98
4300	19.09	38.84	18.79	16.21	4.72	0.98	23.82	13.12	3.81
4500	19.02	39.43	19.75	15.55	5.07	0.98	24.41	13.63	3.84
4700	18.95	39.07	18.63	15.89	4.90	0.98	24.90	14.08	3.72
4900	18.59	38.36	17.07	17.35	4.72	0.99	26.02	14.82	3.77
5100	18.24	37.63	15.36	21.19	4.53	1.01	27.23	16.00	3.75
5300	17.42	37.35	13.58	28.35	4.78	1.03	28.06	16.31	3.80
5500	16.35	37.06	12.63	25.25	5.17	1.04	27.49	16.43	3.94
5700	14.62	37.46	11.95	18.42	6.46	1.04	26.62	15.78	4.14
5900	12.57	37.10	11.78	14.95	7.69	1.02	24.77	13.77	4.54
6100	10.56	35.81	11.41	13.21	8.17	1.01	22.31	11.29	5.02
6300	8.35	36.17	11.76	12.13	10.86	0.99	19.11	8.51	5.64
6500	6.03	36.80	12.24	11.07	15.05	0.97	15.12	5.59	6.48

Typical Performance Data

Definitions:

Input Return Loss = -S11 (dB)

Gain(Power Gain) = S21 (dB)

Reverse Isolation = -S12 (dB)

Output Return Loss = -S22 (dB)

TEST CONDITIONS: Vd = 5.25V, Id = 77.36mA @ Temperature = +25°C

FREQ	Gain	Isolation	Input Return Loss	Output Return Loss	Stability		IP-3 Output	1dB Comp. Output	Noise Figure
					K	Measure			
(MHz)	(dB)	(dB)	(dB)	(dB)	K	Measure	(dBm)	(dBm)	(dB)
1000	15.44	73.48	3.93	19.45	234.99	1.39	25.55	13.74	8.54
1100	16.44	74.11	4.55	22.51	246.75	1.34	27.37	15.51	8.00
1200	17.19	62.81	5.27	26.68	67.01	1.29	28.50	16.54	7.54
1300	17.71	57.37	6.02	31.99	36.02	1.25	29.10	17.03	7.07
1400	18.06	54.35	6.79	37.74	25.77	1.21	29.16	17.25	6.79
1500	18.29	52.22	7.56	39.12	20.51	1.17	28.90	17.15	6.44
1600	18.39	50.30	8.35	36.88	16.83	1.15	28.75	16.94	6.19
1700	18.45	49.08	9.12	34.58	14.93	1.12	28.72	17.07	6.00
1800	18.44	47.90	9.91	33.65	13.36	1.10	28.94	16.99	5.78
1900	18.41	46.75	10.66	32.53	11.96	1.08	28.78	17.04	5.62
2000	18.37	46.09	11.31	31.21	11.28	1.07	28.50	16.91	5.48
2100	18.32	45.45	12.03	30.58	10.66	1.06	28.15	16.56	5.28
2200	18.25	44.85	12.76	29.64	10.13	1.05	27.70	16.36	5.15
2300	18.20	44.22	13.47	28.15	9.55	1.04	27.69	16.49	5.00
2400	18.22	43.83	14.19	27.17	9.17	1.03	27.53	16.33	4.87
2500	18.16	43.53	14.89	26.30	8.98	1.03	27.22	16.10	4.78
2600	18.17	43.16	15.69	25.32	8.63	1.02	26.96	15.86	4.74
2700	18.19	43.08	16.63	24.67	8.58	1.02	26.77	15.64	4.68
2800	18.22	42.52	17.28	24.06	8.04	1.01	26.49	15.37	4.65
2900	18.28	41.77	17.87	23.47	7.34	1.01	26.32	15.18	4.63
3000	18.34	41.35	18.52	23.11	6.96	1.01	25.87	14.85	4.44
3100	18.38	41.13	19.12	23.19	6.77	1.00	25.72	14.73	4.35
3300	18.52	40.71	20.07	23.12	6.37	1.00	25.27	14.43	4.29
3500	18.68	40.04	20.22	22.34	5.79	1.00	25.27	14.37	4.11
3700	18.97	39.58	19.65	22.29	5.31	1.00	25.05	14.06	4.05
3900	19.31	39.21	18.98	22.19	4.89	1.00	24.76	13.85	3.96
4100	19.61	40.11	18.94	20.73	5.22	1.00	24.59	13.64	3.83
4300	19.95	39.58	19.21	21.42	4.74	1.00	24.52	13.70	3.77
4500	19.76	40.48	19.99	20.18	5.36	0.99	25.22	14.31	3.73
4700	19.57	40.31	18.52	20.68	5.36	1.00	25.88	14.68	3.70
4900	19.10	39.64	17.00	22.12	5.22	1.01	26.94	15.99	3.71
5100	18.73	38.93	15.59	26.83	5.01	1.02	28.32	16.40	3.57
5300	18.03	38.76	14.06	27.76	5.26	1.03	28.61	17.00	3.71
5500	17.24	38.29	13.32	22.26	5.40	1.03	29.17	17.52	3.89
5700	15.85	38.74	12.63	17.90	6.55	1.03	28.45	16.98	4.00
5900	14.10	38.03	12.46	14.77	7.24	1.01	26.79	15.41	4.28
6100	12.31	36.55	11.94	13.25	7.35	1.00	24.60	12.96	4.73
6300	10.19	37.25	12.26	11.90	9.98	0.98	21.46	10.08	5.26
6500	7.86	38.26	12.83	10.71	14.42	0.96	17.82	7.24	6.02

Typical Performance Data

Definitions:

Input Return Loss = -S11 (dB)

Gain(Power Gain) = S21 (dB)

Reverse Isolation = -S12 (dB)

Output Return Loss = -S22 (dB)

TEST CONDITIONS: Vd = 5.00V, Id = 74.65mA @ Temperature = -45°C

FREQ	Gain	Isolation	Input Return Loss	Output Return Loss	Stability		IP-3 Output	1dB Comp. Output	Noise Figure
					K	Measure			
(MHz)	(dB)	(dB)	(dB)	(dB)	K	Measure	(dBm)	(dBm)	(dB)
1000	16.02	73.47	3.76	19.12	213.08	1.40	25.83	13.50	7.53
1100	17.06	73.50	4.37	21.93	209.03	1.36	27.70	15.25	7.05
1200	17.84	62.61	5.09	25.59	59.56	1.31	28.86	16.24	6.57
1300	18.39	57.39	5.83	30.31	32.89	1.26	29.53	16.75	6.13
1400	18.77	54.43	6.59	35.53	23.68	1.22	29.57	17.01	5.88
1500	19.01	52.20	7.33	37.55	18.62	1.18	29.53	16.88	5.54
1600	19.12	50.16	8.14	36.97	15.11	1.15	29.24	16.68	5.34
1700	19.19	48.93	8.93	35.31	13.39	1.13	29.27	16.81	5.17
1800	19.20	47.99	9.69	33.71	12.29	1.11	29.39	16.76	4.92
1900	19.15	46.83	10.46	32.87	11.04	1.09	29.27	16.88	4.81
2000	19.11	46.04	11.12	31.77	10.26	1.07	28.96	16.73	4.65
2100	19.08	45.43	11.78	31.13	9.72	1.06	28.57	16.41	4.46
2200	18.99	44.83	12.42	30.52	9.25	1.05	28.12	16.16	4.33
2300	18.95	44.21	13.07	29.26	8.73	1.05	28.17	16.37	4.23
2400	18.95	43.81	13.82	28.18	8.39	1.04	28.01	16.25	4.07
2500	18.91	43.38	14.48	26.90	8.08	1.03	27.67	16.04	3.97
2600	18.93	43.10	15.15	25.88	7.83	1.02	27.47	15.93	3.98
2700	18.95	42.98	16.10	24.96	7.75	1.02	27.20	15.68	3.87
2800	18.98	42.34	16.94	23.66	7.20	1.01	27.01	15.45	3.90
2900	19.04	41.70	17.64	22.86	6.67	1.01	26.84	15.27	3.84
3000	19.14	41.20	18.23	22.33	6.24	1.00	26.39	14.91	3.67
3100	19.19	40.88	18.54	22.40	5.99	1.00	26.21	14.81	3.58
3300	19.33	40.70	19.16	22.57	5.79	1.00	25.70	14.45	3.49
3500	19.56	40.00	19.23	22.05	5.20	1.00	25.79	14.47	3.38
3700	19.84	39.43	18.87	22.48	4.73	1.00	25.60	14.25	3.31
3900	20.27	39.00	18.13	23.08	4.28	1.00	25.38	14.00	3.21
4100	20.59	39.84	17.86	20.67	4.51	1.00	25.10	13.82	3.11
4300	21.10	39.52	18.18	20.26	4.11	0.99	24.78	13.74	3.01
4500	20.78	40.31	18.76	18.70	4.65	0.99	25.70	14.34	3.02
4700	20.58	40.17	17.99	19.35	4.68	1.00	26.16	14.65	2.96
4900	20.24	39.46	16.80	20.63	4.48	1.00	27.40	15.77	2.95
5100	19.66	39.10	15.67	23.69	4.59	1.01	28.67	16.44	2.87
5300	19.14	38.82	13.95	24.46	4.66	1.03	29.32	17.05	3.00
5500	18.30	38.63	12.93	20.99	4.95	1.03	30.34	17.34	3.19
5700	17.06	38.31	12.51	17.75	5.42	1.03	30.11	17.35	3.21
5900	15.46	37.58	12.18	15.31	5.90	1.02	28.88	16.46	3.44
6100	13.82	36.84	11.44	14.07	6.39	1.02	26.60	14.43	3.70
6300	11.85	36.83	11.22	12.94	7.86	1.01	23.56	11.66	4.21
6500	9.60	37.65	11.92	11.36	11.02	0.98	19.69	8.67	4.89

Typical Performance Data

Definitions:

Input Return Loss = -S11 (dB)

Gain(Power Gain) = S21 (dB)

Reverse Isolation = -S12 (dB)

Output Return Loss = -S22 (dB)

TEST CONDITIONS: Vd = 3.90V, Id = 73.45mA @ Temperature = -45°C

FREQ	Gain	Isolation	Input Return Loss	Output Return Loss	Stability		IP-3 Output	1dB Comp. Output	Noise Figure
					K	Measure			
(MHz)	(dB)	(dB)	(dB)	(dB)	K	Measure	(dBm)	(dBm)	(dB)
1000	15.34	72.04	3.81	18.35	196.91	1.40	25.01	12.75	7.63
1100	16.33	69.38	4.43	20.84	142.48	1.35	26.64	14.50	7.16
1200	17.07	61.90	5.14	24.09	60.24	1.30	27.74	15.58	6.67
1300	17.62	57.16	5.86	28.51	35.06	1.26	28.44	16.15	6.27
1400	18.00	54.36	6.58	35.71	25.66	1.22	28.55	16.41	5.97
1500	18.27	52.26	7.29	44.56	20.35	1.19	28.49	16.36	5.69
1600	18.41	50.24	8.06	41.18	16.48	1.16	28.44	16.25	5.45
1700	18.52	48.95	8.81	34.04	14.45	1.13	28.39	16.32	5.26
1800	18.57	47.91	9.53	30.85	13.04	1.11	28.62	16.32	5.05
1900	18.54	46.66	10.27	28.95	11.54	1.09	28.55	16.41	4.92
2000	18.53	45.85	10.89	27.26	10.68	1.08	28.31	16.29	4.74
2100	18.52	45.23	11.49	26.31	10.06	1.07	27.94	16.08	4.60
2200	18.47	44.60	12.10	25.70	9.50	1.06	27.58	15.88	4.45
2300	18.41	44.01	12.69	24.97	9.01	1.05	27.50	16.01	4.33
2400	18.44	43.56	13.34	24.37	8.59	1.04	27.18	15.89	4.18
2500	18.39	43.11	13.97	23.74	8.25	1.03	27.01	15.73	4.11
2600	18.42	42.81	14.57	23.23	7.99	1.03	26.76	15.55	4.12
2700	18.43	42.66	15.39	22.73	7.88	1.02	26.57	15.40	4.02
2800	18.47	42.06	16.10	21.89	7.34	1.02	26.31	15.16	4.00
2900	18.51	41.48	16.70	21.38	6.86	1.01	26.19	15.02	4.04
3000	18.59	40.95	17.19	20.98	6.41	1.01	25.83	14.74	3.83
3100	18.63	40.71	17.49	21.09	6.22	1.01	25.61	14.64	3.73
3300	18.74	40.40	18.03	21.05	5.94	1.00	25.14	14.32	3.65
3500	18.97	39.97	18.16	20.66	5.51	1.00	24.99	14.35	3.49
3700	19.27	39.70	18.17	20.53	5.16	1.00	24.80	14.08	3.38
3900	19.68	39.25	17.84	20.21	4.68	1.00	24.59	13.87	3.31
4100	20.05	39.72	17.60	18.25	4.70	0.99	24.55	13.77	3.18
4300	20.42	39.64	18.29	17.39	4.46	0.99	24.36	13.81	3.19
4500	20.31	40.18	18.83	16.53	4.79	0.98	25.11	14.37	3.07
4700	20.18	39.50	18.05	17.46	4.51	0.99	25.68	14.59	3.02
4900	19.94	38.86	16.82	19.43	4.32	1.00	26.66	15.55	2.98
5100	19.23	38.15	15.59	24.09	4.32	1.01	27.99	16.20	3.09
5300	18.88	37.67	13.66	30.24	4.21	1.03	28.26	16.80	2.92
5500	17.85	37.78	12.52	24.36	4.73	1.04	27.28	16.90	3.10
5700	16.32	37.32	12.03	18.73	5.26	1.04	26.69	16.84	3.26
5900	14.50	36.99	11.62	15.75	6.12	1.03	25.12	15.73	3.55
6100	12.65	36.26	11.10	14.15	6.80	1.02	22.99	13.44	3.92
6300	10.55	36.27	10.93	12.96	8.51	1.02	20.84	10.56	4.55
6500	8.24	36.66	11.53	11.48	11.46	0.99	17.31	7.53	5.27

Typical Performance Data

Definitions:

Input Return Loss = -S11 (dB)

Gain(Power Gain) = S21 (dB)

Reverse Isolation = -S12 (dB)

Output Return Loss = -S22 (dB)

TEST CONDITIONS: Vd = 5.25V, Id = 74.93mA @ Temperature = -45°C

FREQ	Gain	Isolation	Input Return Loss	Output Return Loss	Stability		IP-3 Output	1dB Comp. Output	Noise Figure
					K	Measure			
(MHz)	(dB)	(dB)	(dB)	(dB)	K	Measure	(dBm)	(dBm)	(dB)
1000	16.10	73.49	3.74	19.26	211.18	1.41	25.90	13.65	7.53
1100	17.16	73.53	4.36	22.14	207.14	1.36	27.77	15.39	7.08
1200	17.93	62.59	5.07	25.87	58.69	1.31	29.02	16.37	6.56
1300	18.49	57.39	5.82	30.58	32.49	1.26	29.53	16.83	6.14
1400	18.85	54.40	6.57	35.31	23.36	1.22	29.69	17.08	5.88
1500	19.09	52.17	7.31	36.51	18.36	1.18	29.54	16.98	5.56
1600	19.20	50.14	8.13	36.09	14.93	1.15	29.37	16.75	5.36
1700	19.26	48.90	8.92	34.98	13.23	1.13	29.32	16.89	5.15
1800	19.27	47.97	9.67	33.89	12.17	1.11	29.39	16.83	4.93
1900	19.21	46.84	10.45	33.46	10.97	1.09	29.44	16.96	4.78
2000	19.17	46.05	11.11	32.57	10.20	1.07	29.13	16.80	4.63
2100	19.13	45.38	11.76	32.06	9.61	1.06	28.72	16.46	4.45
2200	19.04	44.80	12.41	31.41	9.16	1.05	28.30	16.23	4.32
2300	19.00	44.23	13.07	30.00	8.70	1.05	28.30	16.45	4.18
2400	19.00	43.83	13.82	28.70	8.37	1.04	28.12	16.32	4.05
2500	18.95	43.43	14.49	27.28	8.08	1.03	27.79	16.12	3.99
2600	18.98	43.14	15.17	26.15	7.83	1.03	27.63	15.98	3.96
2700	19.00	43.04	16.12	25.13	7.76	1.02	27.36	15.72	3.88
2800	19.03	42.40	16.97	23.77	7.21	1.01	27.12	15.50	3.85
2900	19.10	41.75	17.71	22.90	6.67	1.01	26.95	15.30	3.87
3000	19.19	41.25	18.33	22.30	6.23	1.00	26.47	14.97	3.66
3100	19.24	40.92	18.62	22.35	5.98	1.00	26.35	14.87	3.62
3300	19.39	40.74	19.21	22.35	5.77	1.00	25.83	14.48	3.51
3500	19.62	40.05	19.30	21.80	5.20	1.00	25.93	14.52	3.38
3700	19.89	39.49	18.95	22.17	4.73	1.00	25.70	14.32	3.25
3900	20.33	39.07	18.18	22.88	4.29	1.00	25.48	14.06	3.22
4100	20.66	39.98	17.96	20.65	4.56	1.00	25.14	13.87	3.09
4300	21.14	39.59	18.24	20.45	4.13	0.99	24.92	13.77	3.07
4500	20.82	40.37	18.85	18.93	4.67	0.99	25.77	14.43	3.01
4700	20.60	40.21	17.96	19.65	4.69	1.00	26.27	14.67	2.98
4900	20.25	39.47	16.84	20.98	4.49	1.00	27.63	15.87	2.93
5100	19.65	39.16	15.68	23.97	4.63	1.01	28.98	16.38	2.97
5300	19.13	38.91	13.96	24.07	4.71	1.03	29.63	17.18	2.88
5500	18.31	38.60	12.92	20.68	4.92	1.03	30.53	17.50	3.02
5700	17.10	38.33	12.54	17.44	5.41	1.03	30.42	17.45	3.18
5900	15.53	37.61	12.17	14.99	5.86	1.01	29.09	16.61	3.35
6100	13.91	36.82	11.44	13.77	6.30	1.02	26.77	14.61	3.71
6300	11.96	36.80	11.20	12.64	7.71	1.01	23.76	11.81	4.21
6500	9.71	37.62	11.93	11.14	10.82	0.98	19.93	8.80	4.88

Typical Performance Data

Definitions:

Input Return Loss = -S11 (dB)

Gain(Power Gain) = S21 (dB)

Reverse Isolation = -S12 (dB)

Output Return Loss = -S22 (dB)

TEST CONDITIONS: Vd = 5.00V, Id = 78.64mA @ Temperature = +85°C

FREQ	Gain	Isolation	Input Return Loss	Output Return Loss	Stability		IP-3 Output	1dB Comp. Output	Noise Figure
					K	Measure			
(MHz)	(dB)	(dB)	(dB)	(dB)			(dBm)	(dBm)	(dB)
1000	14.63	69.82	4.08	20.60	173.63	1.38	25.08	13.40	9.47
1100	15.61	74.61	4.72	24.16	294.05	1.33	26.86	15.13	8.94
1200	16.33	64.24	5.46	29.37	88.92	1.28	27.92	16.26	8.45
1300	16.83	58.04	6.23	38.65	43.77	1.24	28.52	16.82	7.97
1400	17.17	54.85	7.02	47.37	30.68	1.20	28.58	17.08	7.66
1500	17.39	52.53	7.81	41.08	23.87	1.17	28.43	17.03	7.31
1600	17.47	50.35	8.62	36.01	19.00	1.14	28.35	16.86	7.06
1700	17.52	48.98	9.40	33.35	16.55	1.11	28.27	16.99	6.85
1800	17.53	47.98	10.16	32.23	15.05	1.09	28.44	16.90	6.62
1900	17.48	46.83	10.90	31.18	13.50	1.08	28.39	16.91	6.45
2000	17.44	46.17	11.53	29.81	12.71	1.07	28.01	16.78	6.29
2100	17.40	45.51	12.24	29.03	11.96	1.06	27.66	16.44	6.10
2200	17.32	44.94	12.94	28.22	11.42	1.05	27.24	16.26	5.97
2300	17.28	44.53	13.68	27.35	11.02	1.04	27.25	16.26	5.81
2400	17.24	44.27	14.52	26.69	10.83	1.03	26.99	16.06	5.68
2500	17.21	43.65	15.23	25.59	10.17	1.03	26.74	15.82	5.57
2600	17.23	43.12	15.92	24.71	9.58	1.02	26.44	15.52	5.58
2700	17.24	42.90	16.74	24.20	9.38	1.02	26.27	15.31	5.49
2800	17.24	42.39	17.58	23.50	8.87	1.01	25.95	15.00	5.46
2900	17.28	42.05	18.50	22.99	8.51	1.01	25.83	14.84	5.45
3000	17.24	41.94	19.46	22.65	8.47	1.00	25.35	14.52	5.30
3100	17.37	41.20	20.00	22.36	7.67	1.00	25.20	14.37	5.17
3300	17.48	40.60	21.16	22.15	7.09	1.00	24.75	14.05	5.07
3500	17.66	40.17	21.70	21.48	6.61	1.00	24.70	13.91	4.90
3700	17.89	39.61	21.33	21.69	6.04	0.99	24.53	13.62	4.80
3900	18.19	39.49	20.97	21.66	5.76	0.99	24.32	13.42	4.70
4100	18.50	40.46	21.18	20.62	6.20	0.99	24.17	13.25	4.57
4300	18.75	40.21	21.56	21.03	5.87	0.99	24.13	13.40	4.47
4500	18.60	40.25	21.66	21.30	5.99	0.99	24.91	14.01	4.47
4700	18.43	39.70	19.63	22.23	5.73	1.00	25.63	14.48	4.38
4900	18.13	39.23	17.32	25.55	5.59	1.01	26.85	15.55	4.40
5100	17.72	39.08	15.46	32.39	5.72	1.02	27.87	16.28	4.39
5300	16.77	38.76	13.95	31.15	6.08	1.03	28.32	16.71	4.50
5500	15.94	38.92	13.34	21.26	6.72	1.03	28.55	17.20	4.66
5700	14.39	37.69	13.00	16.48	6.86	1.02	27.49	16.28	4.85
5900	12.65	37.64	12.88	13.97	8.15	1.00	25.61	14.20	5.25
6100	10.76	37.28	13.01	12.44	9.57	0.98	23.15	11.57	5.75
6300	8.53	37.45	13.45	11.36	12.42	0.96	19.75	8.66	6.41
6500	6.15	37.78	13.96	10.56	16.76	0.95	15.94	5.86	7.30

Typical Performance Data

Definitions:

Input Return Loss = -S11 (dB)

Gain(Power Gain) = S21 (dB)

Reverse Isolation = -S12 (dB)

Output Return Loss = -S22 (dB)

TEST CONDITIONS: Vd = 3.90V, Id = 76.71mA @ Temperature = +85°C

FREQ	Gain	Isolation	Input Return Loss	Output Return Loss	Stability		IP-3 Output	1dB Comp. Output	Noise Figure
					K	Measure			
(MHz)	(dB)	(dB)	(dB)	(dB)	K	Measure	(dBm)	(dBm)	(dB)
1000	13.82	74.22	4.16	20.39	319.38	1.37	23.93	12.43	9.52
1100	14.74	72.13	4.79	23.82	246.18	1.33	25.57	14.07	9.03
1200	15.43	61.53	5.53	28.48	72.54	1.28	26.67	15.16	8.51
1300	15.93	56.79	6.28	32.56	42.23	1.23	27.18	15.67	8.07
1400	16.27	53.99	7.04	32.72	30.81	1.20	27.30	15.95	7.75
1500	16.52	51.83	7.79	30.14	24.30	1.16	27.16	15.95	7.43
1600	16.63	49.74	8.57	28.06	19.46	1.14	27.14	15.91	7.21
1700	16.71	48.39	9.30	26.48	16.93	1.11	27.07	15.98	6.98
1800	16.75	47.43	10.03	25.44	15.38	1.09	27.31	15.92	6.75
1900	16.73	46.29	10.73	24.65	13.75	1.08	27.27	15.93	6.57
2000	16.71	45.60	11.33	23.88	12.86	1.07	26.93	15.80	6.47
2100	16.69	44.89	11.98	23.48	12.01	1.06	26.70	15.65	6.26
2200	16.62	44.31	12.64	23.17	11.42	1.05	26.31	15.49	6.11
2300	16.59	43.86	13.31	22.88	10.97	1.04	26.20	15.27	6.00
2400	16.58	43.56	14.06	22.87	10.70	1.03	25.93	15.07	5.83
2500	16.54	42.91	14.70	22.46	10.02	1.03	25.71	14.89	5.70
2600	16.55	42.37	15.30	22.01	9.44	1.02	25.50	14.58	5.72
2700	16.56	42.15	16.02	21.83	9.24	1.02	25.37	14.53	5.63
2800	16.55	41.63	16.73	21.43	8.74	1.01	25.09	14.18	5.60
2900	16.58	41.24	17.49	21.17	8.36	1.01	24.91	14.03	5.60
3000	16.56	41.06	18.31	21.04	8.23	1.00	24.54	13.76	5.41
3100	16.64	40.41	18.76	20.77	7.57	1.00	24.44	13.64	5.28
3300	16.72	39.91	19.83	20.70	7.11	1.00	24.08	13.38	5.20
3500	16.88	39.49	20.40	19.96	6.65	0.99	23.82	13.18	5.04
3700	17.07	39.05	20.40	19.49	6.18	0.99	23.70	12.94	4.92
3900	17.37	38.99	20.33	18.64	5.92	0.99	23.53	12.69	4.82
4100	17.69	39.77	20.72	17.10	6.21	0.98	23.47	12.61	4.69
4300	18.00	39.41	21.34	16.66	5.75	0.98	23.45	12.74	4.59
4500	17.95	39.32	21.64	16.59	5.72	0.98	24.07	13.29	4.52
4700	17.88	38.70	19.73	17.15	5.36	0.99	24.77	13.79	4.45
4900	17.65	38.12	17.29	19.07	5.14	1.00	25.78	14.68	4.45
5100	17.24	37.88	15.17	22.81	5.23	1.02	27.09	15.56	4.47
5300	16.19	37.55	13.46	26.82	5.62	1.04	27.58	16.01	4.56
5500	15.11	37.74	12.74	21.95	6.42	1.04	27.41	16.07	4.76
5700	13.29	36.82	12.36	16.46	6.98	1.02	26.19	14.88	4.98
5900	11.32	36.86	12.34	13.91	8.63	1.01	24.00	12.62	5.42
6100	9.24	36.41	12.54	12.50	10.24	0.99	21.34	9.94	6.04
6300	6.98	36.31	13.00	11.57	13.01	0.97	17.67	7.12	6.81
6500	4.62	36.65	13.50	10.81	17.57	0.95	13.50	4.39	7.78

Typical Performance Data

Definitions:

Input Return Loss = -S11 (dB)

Gain(Power Gain) = S21 (dB)

Reverse Isolation = -S12 (dB)

Output Return Loss = -S22 (dB)

TEST CONDITIONS: Vd = 5.25V, Id = 78.86mA @ Temperature = +85°C

FREQ	Gain	Isolation	Input Return Loss	Output Return Loss	Stability		IP-3 Output	1dB Comp. Output	Noise Figure
					K	Measure			
(MHz)	(dB)	(dB)	(dB)	(dB)	K	Measure	(dBm)	(dBm)	(dB)
1000	14.74	68.22	4.07	20.67	142.31	1.38	25.22	13.54	9.47
1100	15.73	73.98	4.70	24.23	269.12	1.33	27.01	15.30	8.94
1200	16.46	64.75	5.45	29.33	92.79	1.28	28.24	16.39	8.41
1300	16.96	58.29	6.23	37.26	44.37	1.24	28.76	16.95	7.93
1400	17.29	55.01	7.02	45.38	30.82	1.20	28.72	17.21	7.65
1500	17.50	52.65	7.81	42.90	23.88	1.17	28.68	17.15	7.25
1600	17.58	50.46	8.63	37.89	19.03	1.14	28.48	16.96	7.00
1700	17.62	49.07	9.41	34.99	16.54	1.11	28.45	17.12	6.84
1800	17.62	48.09	10.17	33.86	15.09	1.09	28.57	16.99	6.60
1900	17.56	46.97	10.92	32.63	13.59	1.08	28.58	17.04	6.43
2000	17.52	46.29	11.56	30.97	12.77	1.07	28.21	16.90	6.25
2100	17.47	45.62	12.26	29.89	12.02	1.06	27.72	16.54	6.05
2200	17.39	45.07	12.97	28.79	11.50	1.05	27.39	16.36	5.95
2300	17.34	44.65	13.71	27.63	11.10	1.04	27.39	16.36	5.80
2400	17.31	44.40	14.56	26.70	10.91	1.03	27.15	16.15	5.67
2500	17.27	43.77	15.29	25.46	10.24	1.03	26.86	15.91	5.56
2600	17.29	43.25	15.99	24.54	9.66	1.02	26.61	15.63	5.53
2700	17.30	43.06	16.83	23.96	9.49	1.01	26.31	15.38	5.46
2800	17.30	42.54	17.68	23.24	8.96	1.01	26.10	15.10	5.46
2900	17.35	42.16	18.60	22.67	8.55	1.01	25.91	14.91	5.41
3000	17.35	42.00	19.61	22.16	8.42	1.00	25.48	14.59	5.28
3100	17.44	41.30	20.14	21.99	7.70	1.00	25.36	14.44	5.14
3300	17.55	40.76	21.39	21.67	7.16	1.00	24.85	14.11	5.06
3500	17.75	40.32	21.96	21.02	6.65	0.99	24.82	13.99	4.89
3700	17.98	39.76	21.62	21.25	6.09	0.99	24.63	13.70	4.78
3900	18.29	39.64	21.22	21.41	5.79	0.99	24.41	13.47	4.70
4100	18.59	40.66	21.48	20.78	6.28	0.99	24.20	13.31	4.53
4300	18.84	40.39	21.90	21.69	5.93	0.99	24.22	13.47	4.49
4500	18.67	40.50	21.83	22.26	6.13	1.00	25.03	14.09	4.44
4700	18.48	39.90	19.55	23.48	5.83	1.00	25.73	14.56	4.38
4900	18.16	39.40	17.28	27.55	5.69	1.01	26.96	15.65	4.37
5100	17.74	39.22	15.45	32.93	5.80	1.02	28.03	16.34	4.40
5300	16.81	38.96	13.97	28.22	6.18	1.03	28.38	16.75	4.52
5500	16.04	39.12	13.41	20.37	6.79	1.03	28.81	17.35	4.68
5700	14.54	37.79	13.07	16.12	6.81	1.01	27.75	16.45	4.83
5900	12.85	37.79	12.99	13.72	8.10	1.00	25.92	14.45	5.20
6100	10.97	37.44	13.14	12.18	9.48	0.98	23.56	11.81	5.72
6300	8.76	37.53	13.60	11.10	12.16	0.96	20.03	8.90	6.40
6500	6.37	37.97	14.16	10.31	16.65	0.94	16.22	6.09	7.29

Typical Performance Data

NOTE: Use PDF Bookmarks to view DATA at required conditions

Definitions:

Input Return Loss = -S11 (dB)

Gain(Power Gain) = S21 (dB)

Reverse Isolation = -S12 (dB)

Output Return Loss = -S22 (dB)

TEST CONDITIONS: Vd = 2.80V, Id = 73.30mA @ Temperature = +25°C

FREQ	Gain	Isolation	Input Return Loss	Output Return Loss	Stability		IP-3 Output	1dB Comp. Output	Noise Figure
					K	Measure			
(MHz)	(dB)	(dB)	(dB)	(dB)	K	Measure	(dBm)	(dBm)	(dB)
1000	12.96	71.69	4.18	17.90	262.50	1.36	21.67	10.54	8.91
1100	13.79	62.99	4.79	19.63	95.32	1.32	22.81	11.53	8.45
1200	14.42	57.67	5.49	21.27	51.74	1.27	23.62	12.20	7.99
1300	14.90	54.42	6.17	22.22	35.69	1.23	23.98	12.45	7.53
1400	15.25	52.20	6.86	22.35	27.79	1.20	24.09	12.65	7.28
1500	15.52	50.46	7.53	21.84	22.88	1.17	24.07	12.76	6.93
1600	15.68	48.80	8.20	21.10	19.13	1.14	24.31	12.95	6.71
1700	15.80	47.67	8.85	20.29	16.94	1.12	24.19	12.96	6.57
1800	15.86	46.50	9.52	19.65	15.00	1.10	24.49	13.06	6.33
1900	15.89	45.38	10.13	19.00	13.33	1.08	24.64	13.17	6.15
2000	15.91	44.73	10.65	18.38	12.47	1.07	24.37	13.13	6.02
2100	15.92	44.07	11.24	17.98	11.66	1.05	24.43	13.33	5.82
2200	15.89	43.41	11.81	17.67	10.95	1.04	24.13	13.27	5.72
2300	15.88	42.72	12.35	17.29	10.19	1.04	23.90	12.95	5.59
2400	15.90	42.25	12.88	17.02	9.68	1.03	23.67	12.79	5.44
2500	15.86	41.87	13.40	16.78	9.36	1.02	23.65	12.79	5.32
2600	15.87	41.43	13.97	16.54	8.92	1.01	23.45	12.48	5.31
2700	15.87	41.25	14.62	16.45	8.79	1.01	23.47	12.61	5.22
2800	15.88	40.69	15.05	16.15	8.24	1.00	23.25	12.40	5.21
2900	15.90	39.98	15.43	15.81	7.59	1.00	23.14	12.34	5.21
3000	15.93	39.56	15.87	15.59	7.22	0.99	23.04	12.31	4.96
3100	15.92	39.37	16.31	15.45	7.07	0.99	22.85	12.20	4.90
3300	15.97	39.10	17.15	15.21	6.84	0.99	22.61	12.10	4.83
3500	16.04	38.53	17.52	14.49	6.33	0.98	22.09	11.86	4.61
3700	16.25	38.30	17.68	13.82	5.99	0.97	21.96	11.58	4.50
3900	16.57	38.12	17.88	12.92	5.61	0.96	21.84	11.36	4.34
4100	16.90	38.53	18.38	11.88	5.59	0.94	21.95	11.35	4.19
4300	17.32	37.82	19.33	11.66	4.91	0.94	21.96	11.50	4.07
4500	17.42	37.96	20.38	11.52	4.93	0.93	22.27	11.86	3.99
4700	17.52	37.32	19.26	12.03	4.55	0.94	22.99	12.29	3.89
4900	17.34	36.48	17.12	13.39	4.26	0.97	23.71	12.93	3.86
5100	16.96	35.71	14.70	15.64	4.11	1.00	25.34	13.68	3.89
5300	16.01	35.44	12.59	16.85	4.39	1.02	25.43	14.13	3.96
5500	14.50	35.33	11.56	15.28	5.04	1.02	24.33	13.51	4.18
5700	12.41	35.64	11.06	13.00	6.44	1.01	23.29	12.70	4.47
5900	10.09	35.63	11.03	11.36	8.18	0.99	21.24	10.74	4.95
6100	7.89	34.56	10.92	10.37	9.10	0.97	18.57	8.26	5.56
6300	5.62	34.20	11.36	9.89	11.27	0.96	15.23	5.59	6.33
6500	3.31	34.36	11.82	9.40	14.85	0.94	11.46	2.87	7.28

Typical Performance Data

Definitions:

Input Return Loss = -S11 (dB)

Gain(Power Gain) = S21 (dB)

Reverse Isolation = -S12 (dB)

Output Return Loss = -S22 (dB)

TEST CONDITIONS: Vd = 2.66V, Id = 72.27mA @ Temperature = +25°C

FREQ	Gain	Isolation	Input Return Loss	Output Return Loss	Stability		IP-3 Output	1dB Comp. Output	Noise Figure
					K	Measure			
(MHz)	(dB)	(dB)	(dB)	(dB)	K	Measure	(dBm)	(dBm)	(dB)
1000	12.70	69.87	4.20	17.62	219.59	1.36	21.04	9.93	8.96
1100	13.52	62.28	4.81	19.16	90.74	1.31	22.08	10.73	8.50
1200	14.14	57.35	5.50	20.53	51.52	1.27	22.85	11.34	8.02
1300	14.61	54.20	6.18	21.28	35.94	1.23	23.18	11.58	7.59
1400	14.96	52.02	6.86	21.33	28.10	1.20	23.33	11.79	7.34
1500	15.23	50.29	7.52	20.88	23.18	1.17	23.33	11.89	6.97
1600	15.39	48.64	8.19	20.24	19.36	1.14	23.60	12.12	6.74
1700	15.51	47.51	8.82	19.52	17.16	1.12	23.48	12.12	6.61
1800	15.58	46.38	9.48	18.94	15.24	1.10	23.79	12.24	6.37
1900	15.62	45.26	10.08	18.34	13.54	1.08	23.94	12.39	6.23
2000	15.64	44.62	10.60	17.76	12.66	1.07	23.71	12.37	6.08
2100	15.65	43.94	11.17	17.37	11.82	1.05	23.81	12.61	5.89
2200	15.62	43.28	11.73	17.06	11.09	1.04	23.50	12.54	5.74
2300	15.61	42.60	12.27	16.70	10.33	1.03	23.33	12.28	5.64
2400	15.64	42.12	12.79	16.43	9.80	1.03	23.09	12.09	5.48
2500	15.60	41.76	13.29	16.19	9.48	1.02	23.09	12.09	5.40
2600	15.60	41.31	13.85	15.94	9.04	1.01	22.89	11.86	5.40
2700	15.60	41.12	14.48	15.84	8.88	1.01	22.95	11.97	5.32
2800	15.61	40.55	14.90	15.54	8.33	1.00	22.71	11.76	5.29
2900	15.63	39.85	15.28	15.21	7.67	1.00	22.65	11.74	5.27
3000	15.65	39.42	15.72	14.98	7.30	0.99	22.59	11.75	5.06
3100	15.64	39.24	16.15	14.83	7.16	0.99	22.39	11.67	4.99
3300	15.68	38.99	17.00	14.57	6.94	0.98	22.20	11.64	4.87
3500	15.74	38.42	17.39	13.87	6.43	0.97	21.66	11.34	4.67
3700	15.95	38.21	17.61	13.21	6.10	0.97	21.56	11.07	4.55
3900	16.26	38.04	17.90	12.35	5.71	0.95	21.42	10.86	4.40
4100	16.59	38.41	18.45	11.38	5.66	0.94	21.59	10.88	4.26
4300	17.02	37.67	19.48	11.18	4.96	0.93	21.57	11.07	4.08
4500	17.14	37.74	20.59	11.10	4.92	0.93	21.83	11.36	4.06
4700	17.28	37.07	19.43	11.63	4.52	0.94	22.57	11.85	3.96
4900	17.12	36.20	17.10	12.97	4.21	0.96	23.23	12.13	3.89
5100	16.74	35.44	14.56	15.04	4.06	0.99	24.85	13.38	3.94
5300	15.76	35.17	12.42	15.93	4.35	1.02	25.02	13.41	3.96
5500	14.20	35.11	11.41	14.37	5.04	1.02	23.81	12.72	4.16
5700	12.05	35.41	10.94	12.31	6.46	1.00	22.71	11.93	4.45
5900	9.70	35.41	10.93	10.85	8.24	0.98	20.63	10.05	4.93
6100	7.49	34.36	10.87	9.95	9.21	0.96	17.92	7.64	5.61
6300	5.21	33.92	11.32	9.53	11.33	0.95	14.55	5.10	6.45
6500	2.90	34.01	11.78	9.10	14.81	0.93	11.07	2.38	7.44

Typical Performance Data

Definitions:

Input Return Loss = -S11 (dB)

Gain(Power Gain) = S21 (dB)

Reverse Isolation = -S12 (dB)

Output Return Loss = -S22 (dB)

TEST CONDITIONS: Vd = 3.00V, Id = 74.47mA @ Temperature = +25°C

FREQ	Gain	Isolation	Input Return Loss	Output Return Loss	Stability		IP-3 Output	1dB Comp. Output	Noise Figure
					K	Measure			
(MHz)	(dB)	(dB)	(dB)	(dB)	K	Measure	(dBm)	(dBm)	(dB)
1000	13.31	73.93	4.14	18.19	324.99	1.36	22.41	11.19	8.84
1100	14.16	63.75	4.76	20.20	99.36	1.32	23.70	12.40	8.38
1200	14.81	58.21	5.45	22.27	52.54	1.28	24.52	13.20	7.90
1300	15.30	54.80	6.15	23.63	35.62	1.24	24.89	13.50	7.45
1400	15.65	52.51	6.84	23.95	27.50	1.20	25.00	13.69	7.19
1500	15.92	50.71	7.52	23.35	22.52	1.17	24.96	13.76	6.87
1600	16.08	49.00	8.21	22.45	18.72	1.14	25.16	13.91	6.61
1700	16.20	47.86	8.87	21.47	16.58	1.12	25.01	13.90	6.48
1800	16.26	46.72	9.54	20.71	14.75	1.10	25.31	13.98	6.25
1900	16.29	45.57	10.18	19.98	13.07	1.08	25.40	14.08	6.08
2000	16.31	44.89	10.72	19.29	12.19	1.07	25.13	14.00	5.93
2100	16.31	44.22	11.31	18.87	11.40	1.06	25.13	14.11	5.75
2200	16.28	43.58	11.91	18.55	10.72	1.05	24.78	14.03	5.59
2300	16.26	42.88	12.46	18.15	9.99	1.04	24.56	13.73	5.50
2400	16.29	42.43	13.01	17.87	9.50	1.03	24.33	13.57	5.35
2500	16.25	42.07	13.54	17.64	9.20	1.02	24.29	13.52	5.26
2600	16.25	41.62	14.12	17.39	8.78	1.02	24.11	13.24	5.21
2700	16.26	41.44	14.79	17.32	8.63	1.01	24.08	13.29	5.14
2800	16.28	40.86	15.23	17.01	8.08	1.01	23.86	13.05	5.13
2900	16.30	40.16	15.63	16.66	7.44	1.00	23.74	12.97	5.11
3000	16.33	39.74	16.07	16.45	7.08	1.00	23.57	12.86	4.92
3100	16.33	39.54	16.51	16.33	6.93	1.00	23.40	12.77	4.85
3300	16.39	39.27	17.32	16.14	6.69	0.99	23.13	12.63	4.73
3500	16.47	38.66	17.63	15.38	6.16	0.98	22.65	12.42	4.53
3700	16.70	38.40	17.69	14.70	5.81	0.98	22.49	12.11	4.42
3900	17.01	38.20	17.79	13.74	5.43	0.97	22.36	11.91	4.31
4100	17.34	38.68	18.20	12.58	5.46	0.95	22.45	11.84	4.14
4300	17.75	38.03	19.01	12.32	4.84	0.95	22.43	11.95	4.01
4500	17.80	38.25	20.04	12.11	4.92	0.94	22.80	12.39	3.96
4700	17.88	37.66	19.03	12.60	4.58	0.95	23.63	12.80	3.88
4900	17.65	36.90	17.10	13.96	4.34	0.97	24.21	13.55	3.88
5100	17.27	36.05	14.87	16.49	4.14	1.00	25.60	14.32	3.84
5300	16.37	35.74	12.77	18.00	4.39	1.03	25.78	14.84	3.99
5500	14.94	35.77	11.81	16.88	5.10	1.03	24.96	14.37	4.09
5700	12.90	35.98	11.21	14.11	6.41	1.02	23.95	13.58	4.36
5900	10.64	35.96	11.16	12.13	8.09	1.00	21.96	11.57	4.86
6100	8.45	34.80	11.04	10.99	8.91	0.98	19.37	9.00	5.44
6300	6.16	35.08	11.40	10.36	11.85	0.97	16.12	6.30	6.18
6500	3.91	35.01	11.83	9.83	15.11	0.95	12.08	3.53	7.14

Typical Performance Data

Definitions:

Input Return Loss = -S11 (dB)

Gain(Power Gain) = S21 (dB)

Reverse Isolation = -S12 (dB)

Output Return Loss = -S22 (dB)

TEST CONDITIONS: Vd = 2.80V, Id = 70.79mA @ Temperature = -45°C

FREQ	Gain	Isolation	Input Return Loss	Output Return Loss	Stability		IP-3 Output	1dB Comp. Output	Noise Figure
					K	Measure			
(MHz)	(dB)	(dB)	(dB)	(dB)	K	Measure	(dBm)	(dBm)	(dB)
1000	13.84	70.65	3.97	17.91	204.25	1.38	22.55	11.06	7.82
1100	14.72	64.70	4.59	20.26	101.90	1.34	23.65	12.17	7.40
1200	15.39	59.43	5.28	23.36	55.74	1.29	24.54	12.91	6.95
1300	15.90	55.79	5.97	27.63	36.78	1.25	24.99	13.16	6.53
1400	16.28	53.45	6.64	33.66	28.25	1.22	25.18	13.37	6.30
1500	16.57	51.58	7.28	36.51	22.91	1.19	25.20	13.44	5.96
1600	16.75	49.70	7.98	32.97	18.69	1.16	25.50	13.67	5.77
1700	16.89	48.43	8.64	28.71	16.31	1.13	25.34	13.62	5.58
1800	16.98	47.49	9.29	25.94	14.78	1.11	25.62	13.73	5.38
1900	17.01	46.32	9.93	24.09	13.10	1.10	25.74	13.81	5.21
2000	17.04	45.47	10.48	22.62	11.99	1.08	25.48	13.76	5.07
2100	17.06	44.79	11.02	21.64	11.17	1.07	25.68	14.04	4.90
2200	17.03	44.14	11.54	21.01	10.48	1.06	25.39	14.05	4.78
2300	17.02	43.46	12.05	20.39	9.77	1.05	25.03	13.60	4.63
2400	17.05	42.96	12.61	19.96	9.26	1.04	24.76	13.45	4.48
2500	17.03	42.49	13.09	19.51	8.84	1.04	24.74	13.42	4.46
2600	17.05	42.15	13.58	19.13	8.51	1.03	24.43	13.09	4.43
2700	17.07	41.97	14.24	18.87	8.36	1.02	24.65	13.27	4.34
2800	17.09	41.31	14.80	18.34	7.76	1.02	24.29	13.05	4.35
2900	17.13	40.67	15.27	17.98	7.19	1.01	24.22	13.02	4.33
3000	17.19	40.16	15.65	17.76	6.76	1.01	24.13	13.03	4.12
3100	17.20	39.87	15.87	17.79	6.53	1.01	23.95	12.93	4.00
3300	17.27	39.82	16.37	18.25	6.47	1.00	23.82	12.96	3.91
3500	17.40	39.31	16.56	17.35	6.00	1.00	23.27	12.73	3.75
3700	17.64	39.02	16.81	16.83	5.64	1.00	23.11	12.52	3.67
3900	18.06	38.77	16.93	15.82	5.21	0.99	22.90	12.21	3.53
4100	18.44	39.30	17.30	14.11	5.24	0.97	22.94	12.29	3.39
4300	19.01	38.62	18.26	13.81	4.55	0.96	22.98	12.32	3.21
4500	18.98	38.73	19.34	13.56	4.62	0.96	23.28	12.71	3.21
4700	19.07	38.07	18.90	14.54	4.28	0.97	24.05	13.09	3.15
4900	18.95	37.03	17.16	16.52	3.89	0.99	24.28	13.29	3.11
5100	18.41	36.33	15.20	21.02	3.84	1.01	26.03	13.95	3.10
5300	17.71	35.85	12.87	24.87	3.88	1.03	26.69	14.83	3.13
5500	16.29	35.67	11.47	19.91	4.36	1.04	25.82	14.37	3.33
5700	14.36	35.50	10.95	15.65	5.19	1.04	25.07	14.07	3.48
5900	12.17	35.26	10.68	13.60	6.33	1.02	23.35	12.85	3.90
6100	10.05	34.56	10.31	12.32	7.28	1.02	20.77	10.80	4.41
6300	7.80	33.95	10.31	11.37	8.64	1.00	17.99	8.25	5.07
6500	5.46	34.14	10.91	10.29	11.41	0.97	13.59	5.34	5.94

Typical Performance Data

Definitions:

Input Return Loss = -S11 (dB)

Gain(Power Gain) = S21 (dB)

Reverse Isolation = -S12 (dB)

Output Return Loss = -S22 (dB)

TEST CONDITIONS: Vd = 2.66V, Id = 71.05mA @ Temperature = -45°C

FREQ	Gain	Isolation	Input Return Loss	Output Return Loss	Stability		IP-3 Output	1dB Comp. Output	Noise Figure
					K	Measure			
(MHz)	(dB)	(dB)	(dB)	(dB)	K	Measure	(dBm)	(dBm)	(dB)
1000	13.60	70.97	4.00	17.93	218.64	1.38	21.92	10.52	7.93
1100	14.47	64.18	4.62	20.26	99.24	1.33	22.93	11.46	7.46
1200	15.13	59.14	5.31	23.27	55.68	1.29	23.74	12.12	6.99
1300	15.63	55.52	5.99	27.11	36.87	1.25	24.15	12.37	6.58
1400	16.01	53.23	6.66	31.24	28.45	1.21	24.30	12.56	6.30
1500	16.29	51.41	7.30	32.28	23.20	1.18	24.38	12.67	6.03
1600	16.48	49.55	7.98	30.04	18.94	1.16	24.72	12.92	5.78
1700	16.63	48.32	8.64	27.10	16.58	1.13	24.53	12.87	5.61
1800	16.72	47.31	9.28	24.82	14.92	1.11	24.83	13.00	5.41
1900	16.75	46.10	9.92	23.21	13.15	1.09	24.90	13.10	5.28
2000	16.77	45.26	10.46	21.81	12.03	1.08	24.78	13.06	5.11
2100	16.81	44.62	10.98	20.90	11.25	1.07	24.94	13.39	4.94
2200	16.79	43.94	11.49	20.29	10.50	1.06	24.76	13.42	4.83
2300	16.76	43.32	11.97	19.70	9.89	1.05	24.36	12.95	4.74
2400	16.80	42.79	12.50	19.23	9.31	1.04	24.11	12.78	4.58
2500	16.78	42.32	12.99	18.83	8.89	1.03	24.13	12.77	4.47
2600	16.80	42.00	13.47	18.49	8.58	1.03	23.77	12.42	4.46
2700	16.82	41.78	14.12	18.22	8.40	1.02	24.01	12.64	4.39
2800	16.85	41.14	14.67	17.75	7.80	1.01	23.71	12.44	4.40
2900	16.88	40.55	15.13	17.44	7.29	1.01	23.66	12.38	4.36
3000	16.94	40.02	15.51	17.21	6.81	1.01	23.60	12.46	4.16
3100	16.95	39.78	15.78	17.24	6.63	1.00	23.40	12.37	4.08
3300	17.00	39.49	16.22	17.29	6.40	1.00	23.36	12.42	3.98
3500	17.13	39.10	16.45	16.63	6.02	1.00	22.77	12.16	3.78
3700	17.39	39.01	16.81	16.02	5.78	0.99	22.58	11.97	3.68
3900	17.76	38.73	17.00	15.00	5.33	0.98	22.34	11.69	3.55
4100	18.16	38.91	17.28	13.57	5.15	0.97	22.50	11.79	3.40
4300	18.59	38.52	18.31	13.06	4.68	0.96	22.46	11.81	3.35
4500	18.73	38.58	19.19	12.83	4.64	0.95	22.77	12.17	3.21
4700	18.84	37.69	18.79	13.78	4.18	0.96	23.63	12.56	3.19
4900	18.78	36.84	17.26	15.74	3.86	0.98	23.73	12.72	3.08
5100	18.18	36.03	15.08	19.45	3.79	1.01	25.50	13.34	3.13
5300	17.60	35.37	12.60	22.55	3.70	1.03	26.11	14.24	3.07
5500	16.07	35.50	11.38	19.09	4.37	1.04	24.87	13.67	3.31
5700	14.04	35.29	10.77	15.25	5.23	1.04	24.24	13.30	3.55
5900	11.79	35.28	10.63	13.20	6.59	1.02	22.50	12.09	3.95
6100	9.66	34.37	10.27	11.93	7.40	1.01	19.98	10.12	4.48
6300	7.33	34.10	10.27	10.99	9.20	1.00	17.28	7.73	5.22
6500	5.01	34.06	10.85	10.04	11.82	0.97	12.97	4.88	6.10

Typical Performance Data

Definitions:

Input Return Loss = -S11 (dB)

Gain(Power Gain) = S21 (dB)

Reverse Isolation = -S12 (dB)

Output Return Loss = -S22 (dB)

TEST CONDITIONS: Vd = 3.00V, Id = 71.93mA @ Temperature = -45°C

FREQ	Gain	Isolation	Input Return Loss	Output Return Loss	Stability		IP-3 Output	1dB Comp. Output	Noise Figure
					K	Measure			
(MHz)	(dB)	(dB)	(dB)	(dB)	K	Measure	(dBm)	(dBm)	(dB)
1000	14.21	70.57	3.92	17.95	192.23	1.38	23.28	11.54	7.82
1100	15.11	64.98	4.53	20.33	99.99	1.34	24.51	12.96	7.31
1200	15.79	59.79	5.23	23.49	55.14	1.29	25.52	13.76	6.86
1300	16.32	56.02	5.91	27.92	35.88	1.25	26.03	14.10	6.46
1400	16.70	53.61	6.59	34.85	27.35	1.22	26.24	14.30	6.18
1500	16.98	51.69	7.25	38.41	22.09	1.19	26.25	14.36	5.88
1600	17.16	49.78	7.96	34.06	17.99	1.16	26.48	14.53	5.64
1700	17.30	48.55	8.64	29.31	15.78	1.13	26.34	14.48	5.49
1800	17.38	47.51	9.30	26.51	14.16	1.11	26.60	14.56	5.28
1900	17.40	46.27	9.96	24.67	12.47	1.10	26.67	14.66	5.14
2000	17.41	45.45	10.52	23.13	11.47	1.08	26.43	14.59	5.02
2100	17.43	44.83	11.06	22.17	10.76	1.07	26.46	14.76	4.78
2200	17.41	44.15	11.60	21.55	10.07	1.06	26.14	14.73	4.70
2300	17.36	43.50	12.11	20.94	9.46	1.05	25.83	14.38	4.59
2400	17.41	43.02	12.67	20.48	8.97	1.04	25.55	14.26	4.43
2500	17.38	42.55	13.19	20.06	8.57	1.04	25.47	14.23	4.33
2600	17.39	42.24	13.70	19.71	8.29	1.03	25.16	13.88	4.35
2700	17.41	42.07	14.39	19.44	8.16	1.02	25.24	14.01	4.24
2800	17.45	41.44	14.96	18.91	7.58	1.02	24.99	13.77	4.27
2900	17.47	40.84	15.43	18.58	7.08	1.01	24.88	13.69	4.21
3000	17.53	40.31	15.82	18.32	6.63	1.01	24.74	13.64	4.03
3100	17.54	40.08	16.06	18.39	6.45	1.01	24.54	13.57	3.96
3300	17.60	39.77	16.49	18.49	6.20	1.00	24.30	13.54	3.85
3500	17.77	39.44	16.69	17.81	5.86	1.00	23.96	13.36	3.71
3700	18.03	39.34	16.95	17.21	5.61	1.00	23.71	13.12	3.61
3900	18.45	39.14	17.03	16.22	5.21	0.99	23.51	12.87	3.47
4100	18.86	39.40	17.26	14.67	5.08	0.98	23.62	12.90	3.32
4300	19.36	39.03	18.33	14.12	4.60	0.97	23.60	12.93	3.22
4500	19.35	39.20	19.46	13.80	4.69	0.96	23.87	13.34	3.16
4700	19.38	38.23	18.86	14.88	4.22	0.97	24.52	13.66	3.11
4900	19.25	37.42	17.19	16.97	3.94	0.99	24.91	14.02	3.08
5100	18.61	36.55	15.35	21.54	3.86	1.01	26.35	14.65	3.09
5300	18.03	35.97	13.02	26.91	3.80	1.03	27.41	15.52	3.12
5500	16.67	36.06	11.65	21.44	4.38	1.04	27.14	15.25	3.33
5700	14.79	35.71	11.10	16.43	5.10	1.04	26.50	15.00	3.47
5900	12.66	35.56	10.80	14.13	6.24	1.03	24.70	13.81	3.77
6100	10.59	34.83	10.40	12.66	7.10	1.02	21.88	11.67	4.25
6300	8.35	34.49	10.40	11.64	8.69	1.01	18.84	8.96	4.93
6500	6.01	34.61	10.99	10.48	11.38	0.98	14.49	5.95	5.76

Typical Performance Data

Definitions:

Input Return Loss = -S11 (dB)

Gain(Power Gain) = S21 (dB)

Reverse Isolation = -S12 (dB)

Output Return Loss = -S22 (dB)

TEST CONDITIONS: Vd = 2.80V, Id = 73.34mA @ Temperature = +85°C

FREQ	Gain	Isolation	Input Return Loss	Output Return Loss	Stability		IP-3 Output	1dB Comp. Output	Noise Figure
					K	Measure			
(MHz)	(dB)	(dB)	(dB)	(dB)	K	Measure	(dBm)	(dBm)	(dB)
1000	12.38	77.68	4.28	19.02	570.28	1.36	21.20	10.19	9.81
1100	13.21	65.37	4.91	20.89	136.22	1.31	22.39	11.08	9.37
1200	13.84	58.56	5.63	22.44	62.25	1.27	23.21	11.67	8.82
1300	14.30	55.00	6.36	22.96	41.48	1.22	23.56	11.89	8.38
1400	14.64	52.62	7.08	22.62	31.69	1.19	23.72	12.09	8.11
1500	14.89	50.72	7.79	21.84	25.67	1.16	23.67	12.17	7.75
1600	15.03	48.81	8.50	21.07	20.87	1.13	23.93	12.37	7.51
1700	15.13	47.51	9.18	20.29	18.17	1.11	23.73	12.36	7.33
1800	15.19	46.60	9.84	19.62	16.52	1.09	24.04	12.45	7.11
1900	15.20	45.50	10.47	19.04	14.76	1.07	24.17	12.57	6.96
2000	15.20	44.79	11.01	18.46	13.72	1.06	23.91	12.50	6.80
2100	15.20	44.09	11.60	18.07	12.78	1.05	23.89	12.70	6.71
2200	15.16	43.49	12.18	17.76	12.09	1.04	23.57	12.58	6.50
2300	15.13	43.00	12.77	17.46	11.54	1.03	23.36	12.30	6.35
2400	15.12	42.63	13.43	17.33	11.16	1.02	23.12	12.10	6.20
2500	15.09	41.99	13.97	17.07	10.44	1.02	23.10	12.11	6.11
2600	15.09	41.46	14.50	16.75	9.85	1.01	22.87	11.82	6.12
2700	15.09	41.22	15.12	16.56	9.62	1.01	22.85	11.92	6.04
2800	15.07	40.67	15.71	16.28	9.07	1.00	22.65	11.70	6.00
2900	15.08	40.28	16.36	16.08	8.68	1.00	22.52	11.63	5.96
3000	15.03	40.12	17.08	15.96	8.61	0.99	22.39	11.63	5.80
3100	15.10	39.47	17.51	15.68	7.93	0.99	22.19	11.47	5.71
3300	15.13	39.03	18.56	15.40	7.52	0.98	21.94	11.38	5.54
3500	15.24	38.63	19.26	14.85	7.08	0.98	21.41	11.09	5.37
3700	15.41	38.30	19.65	14.26	6.67	0.97	21.41	10.85	5.26
3900	15.69	38.28	20.08	13.55	6.40	0.96	21.31	10.71	5.09
4100	16.01	38.74	20.69	12.65	6.45	0.95	21.47	10.70	4.92
4300	16.36	38.22	21.63	12.33	5.82	0.94	21.47	10.89	4.74
4500	16.46	37.84	22.07	12.43	5.51	0.94	21.87	11.24	4.73
4700	16.57	37.12	19.94	13.03	5.04	0.96	22.56	11.74	4.64
4900	16.47	36.44	17.02	14.40	4.73	0.98	23.32	12.32	4.61
5100	16.05	36.15	14.46	16.16	4.79	1.00	24.63	13.19	4.60
5300	14.84	35.84	12.57	16.59	5.24	1.02	24.67	13.49	4.76
5500	13.38	36.09	11.84	14.86	6.25	1.02	23.52	12.68	4.98
5700	11.24	35.59	11.58	12.55	7.34	1.00	22.31	11.60	5.31
5900	8.99	35.63	11.71	11.19	9.35	0.98	20.09	9.46	5.87
6100	6.75	35.09	12.05	10.46	11.23	0.96	17.34	6.96	6.61
6300	4.47	34.81	12.55	10.02	14.07	0.95	13.62	4.40	7.49
6500	2.14	34.88	13.02	9.60	18.41	0.93	10.79	1.76	8.60

Typical Performance Data

Definitions:

Input Return Loss = -S11 (dB)

Gain(Power Gain) = S21 (dB)

Reverse Isolation = -S12 (dB)

Output Return Loss = -S22 (dB)

TEST CONDITIONS: Vd = 2.66V, Id = 72.96mA @ Temperature = +85°C

FREQ	Gain	Isolation	Input Return Loss	Output Return Loss	Stability		IP-3 Output	1dB Comp. Output	Noise Figure
					K	Measure			
(MHz)	(dB)	(dB)	(dB)	(dB)	K	Measure	(dBm)	(dBm)	(dB)
1000	12.12	75.85	4.31	18.65	476.86	1.35	20.52	9.53	9.90
1100	12.93	64.41	4.93	20.28	125.97	1.31	21.61	10.25	9.39
1200	13.55	58.21	5.65	21.56	61.81	1.26	22.39	10.80	8.90
1300	14.01	54.72	6.37	21.96	41.50	1.22	22.72	11.02	8.42
1400	14.35	52.42	7.08	21.65	32.00	1.19	22.87	11.22	8.18
1500	14.60	50.57	7.78	20.99	26.04	1.16	22.87	11.31	7.82
1600	14.74	48.68	8.49	20.30	21.21	1.13	23.13	11.53	7.56
1700	14.84	47.39	9.15	19.60	18.47	1.11	22.98	11.53	7.39
1800	14.91	46.47	9.80	18.98	16.78	1.09	23.33	11.64	7.17
1900	14.92	45.37	10.42	18.43	14.97	1.07	23.42	11.77	7.01
2000	14.92	44.66	10.95	17.87	13.92	1.06	23.22	11.72	6.90
2100	14.93	43.96	11.53	17.49	12.96	1.05	23.30	11.95	6.69
2200	14.89	43.37	12.10	17.17	12.26	1.04	22.96	11.87	6.54
2300	14.86	42.89	12.67	16.87	11.71	1.03	22.74	11.58	6.44
2400	14.85	42.52	13.31	16.72	11.31	1.02	22.48	11.37	6.27
2500	14.82	41.87	13.84	16.46	10.58	1.02	22.52	11.42	6.21
2600	14.82	41.34	14.35	16.15	9.97	1.01	22.30	11.14	6.18
2700	14.81	41.08	14.96	15.95	9.72	1.00	22.33	11.27	6.07
2800	14.80	40.54	15.54	15.67	9.17	1.00	22.12	11.08	6.11
2900	14.81	40.14	16.17	15.47	8.78	0.99	22.00	11.04	6.03
3000	14.75	40.00	16.85	15.35	8.71	0.99	21.93	11.08	5.86
3100	14.82	39.38	17.28	15.07	8.05	0.99	21.73	10.94	5.72
3300	14.84	38.91	18.34	14.76	7.63	0.98	21.54	10.91	5.60
3500	14.94	38.51	19.07	14.22	7.19	0.97	20.94	10.55	5.42
3700	15.10	38.20	19.54	13.65	6.78	0.96	20.96	10.39	5.28
3900	15.39	38.18	20.04	12.98	6.51	0.96	20.89	10.24	5.14
4100	15.71	38.59	20.70	12.15	6.51	0.94	21.06	10.26	4.97
4300	16.07	38.04	21.70	11.86	5.85	0.94	21.09	10.46	4.83
4500	16.19	37.61	22.10	11.98	5.50	0.94	21.44	10.80	4.73
4700	16.33	36.88	19.90	12.58	5.01	0.95	22.13	11.26	4.68
4900	16.25	36.17	16.90	13.91	4.68	0.97	22.87	11.74	4.63
5100	15.81	35.88	14.27	15.49	4.75	1.00	24.19	12.61	4.65
5300	14.59	35.57	12.37	15.67	5.19	1.02	24.18	12.84	4.82
5500	13.06	35.85	11.65	14.02	6.24	1.01	22.89	11.91	5.06
5700	10.87	35.39	11.43	11.96	7.40	0.99	21.66	10.88	5.38
5900	8.59	35.44	11.60	10.73	9.48	0.97	19.42	8.85	5.98
6100	6.34	34.87	11.95	10.09	11.38	0.95	16.61	6.40	6.66
6300	4.05	34.55	12.48	9.70	14.21	0.94	12.95	3.87	7.57
6500	1.73	34.59	12.97	9.33	18.53	0.92	10.50	1.29	8.69

Typical Performance Data

Definitions:

Input Return Loss = -S11 (dB)

Gain(Power Gain) = S21 (dB)

Reverse Isolation = -S12 (dB)

Output Return Loss = -S22 (dB)

TEST CONDITIONS: Vd = 3.00V, Id = 73.93mA @ Temperature = +85°C

FREQ	Gain	Isolation	Input Return Loss	Output Return Loss	Stability		IP-3 Output	1dB Comp. Output	Noise Figure
					K	Measure			
(MHz)	(dB)	(dB)	(dB)	(dB)	K	Measure	(dBm)	(dBm)	(dB)
1000	12.71	77.37	4.26	19.43	528.23	1.36	21.92	10.84	9.72
1100	13.56	66.83	4.90	21.64	154.66	1.31	23.28	11.94	9.27
1200	14.21	59.12	5.62	23.61	63.65	1.27	24.13	12.67	8.74
1300	14.68	55.35	6.36	24.39	41.38	1.23	24.53	12.95	8.28
1400	15.02	52.90	7.08	24.02	31.41	1.19	24.63	13.12	7.99
1500	15.27	50.96	7.81	23.08	25.31	1.16	24.54	13.21	7.68
1600	15.41	48.99	8.54	22.17	20.46	1.13	24.77	13.34	7.42
1700	15.51	47.69	9.24	21.28	17.80	1.11	24.61	13.39	7.25
1800	15.57	46.75	9.92	20.55	16.17	1.09	24.88	13.42	7.04
1900	15.57	45.63	10.57	19.92	14.43	1.07	24.94	13.54	6.87
2000	15.57	44.91	11.13	19.30	13.41	1.06	24.67	13.41	6.70
2100	15.56	44.23	11.73	18.90	12.52	1.05	24.63	13.57	6.51
2200	15.52	43.63	12.34	18.58	11.84	1.04	24.28	13.45	6.38
2300	15.49	43.17	12.95	18.29	11.34	1.03	24.03	13.13	6.27
2400	15.48	42.81	13.63	18.18	10.98	1.03	23.78	12.91	6.12
2500	15.45	42.16	14.21	17.91	10.27	1.02	23.72	12.88	6.03
2600	15.46	41.63	14.76	17.57	9.68	1.01	23.49	12.55	6.02
2700	15.46	41.36	15.40	17.38	9.43	1.01	23.44	12.60	5.94
2800	15.44	40.81	16.03	17.09	8.89	1.00	23.20	12.42	5.93
2900	15.46	40.43	16.71	16.88	8.51	1.00	23.05	12.28	5.88
3000	15.42	40.26	17.44	16.77	8.41	0.99	22.88	12.23	5.73
3100	15.49	39.61	17.88	16.49	7.74	0.99	22.70	12.08	5.58
3300	15.54	39.11	18.95	16.23	7.30	0.99	22.45	11.91	5.49
3500	15.64	38.68	19.61	15.68	6.85	0.98	22.01	11.62	5.28
3700	15.81	38.28	19.87	15.13	6.40	0.98	22.00	11.42	5.15
3900	16.07	38.22	20.09	14.44	6.14	0.97	21.86	11.22	5.03
4100	16.38	38.75	20.50	13.45	6.24	0.96	21.98	11.22	4.86
4300	16.73	38.31	21.28	13.08	5.70	0.95	21.96	11.38	4.71
4500	16.80	38.04	21.80	13.13	5.48	0.95	22.39	11.80	4.69
4700	16.88	37.41	19.97	13.68	5.06	0.96	23.04	12.29	4.59
4900	16.77	36.77	17.24	15.08	4.78	0.98	23.87	12.95	4.55
5100	16.36	36.52	14.76	17.04	4.86	1.01	25.19	13.85	4.57
5300	15.19	36.18	12.84	17.85	5.28	1.03	25.43	14.23	4.74
5500	13.81	36.43	12.06	16.06	6.25	1.03	24.39	13.59	4.94
5700	11.72	35.83	11.74	13.36	7.22	1.01	23.20	12.47	5.27
5900	9.52	35.89	11.82	11.78	9.18	0.99	20.98	10.24	5.76
6100	7.30	35.36	12.11	10.92	11.00	0.97	18.25	7.66	6.44
6300	5.02	35.14	12.57	10.39	13.86	0.95	14.53	5.01	7.33
6500	2.68	35.25	13.04	9.90	18.21	0.94	11.23	2.41	8.34

Typical Performance Curves

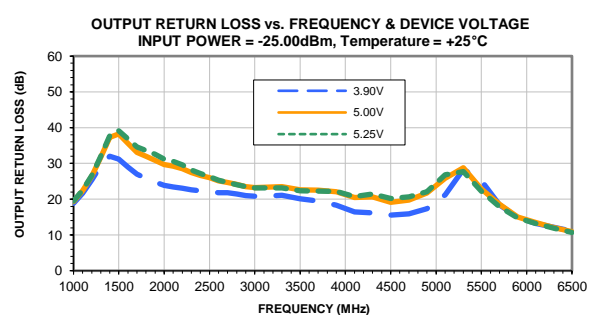
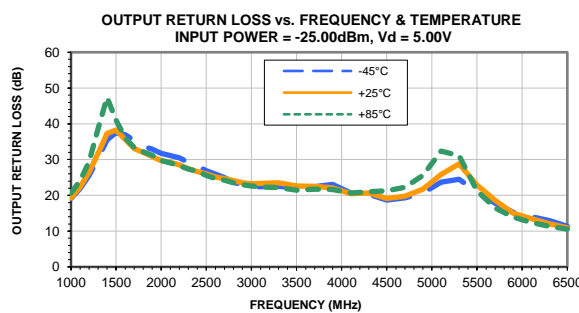
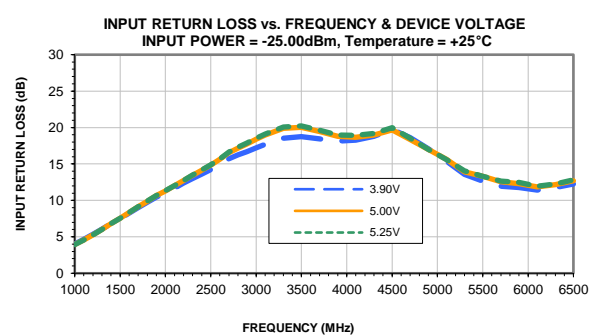
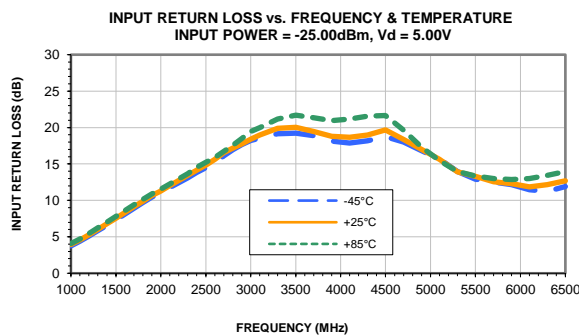
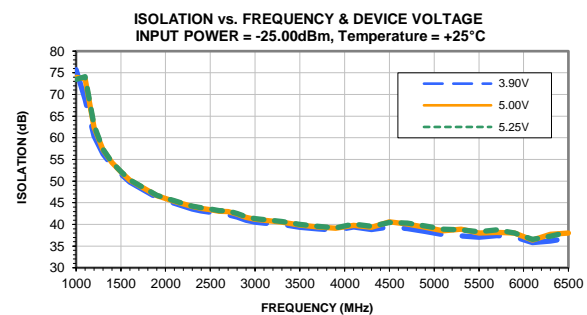
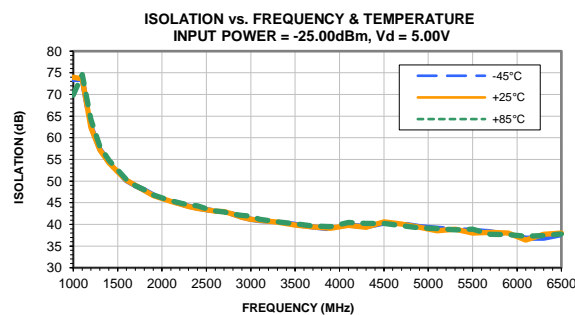
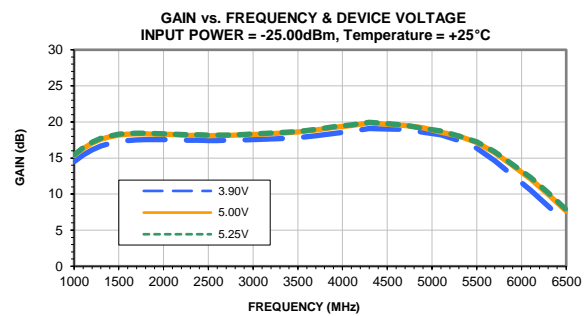
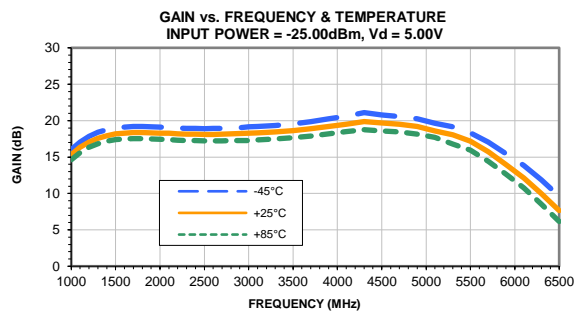

Typical Performance Curves

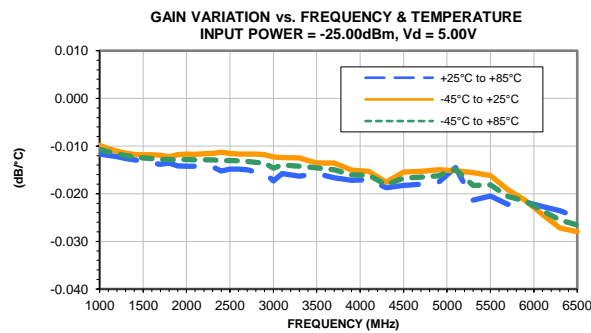
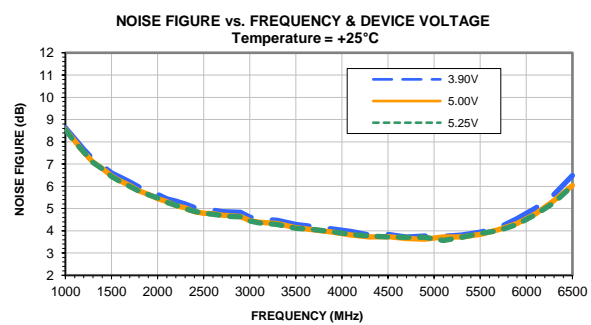
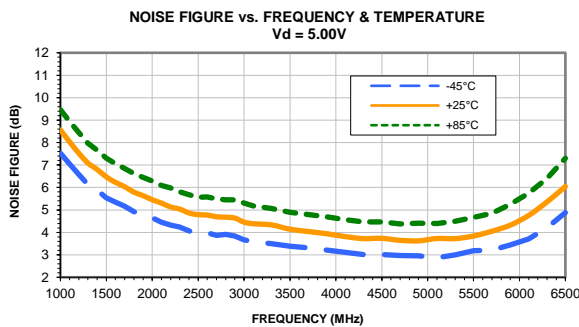
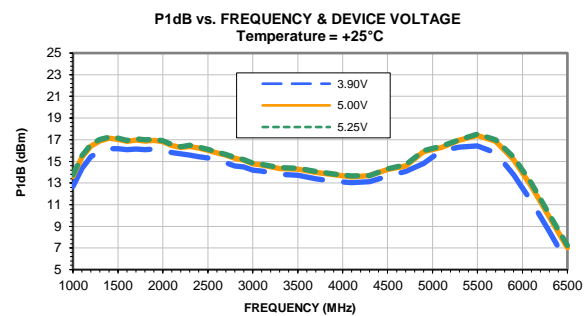
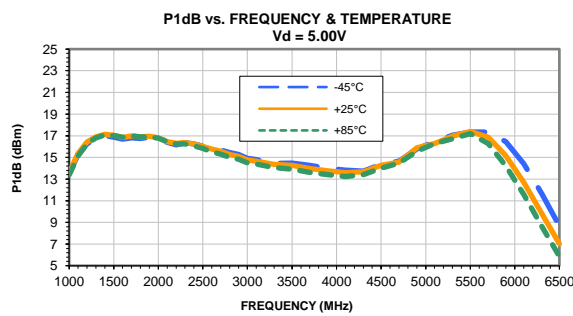
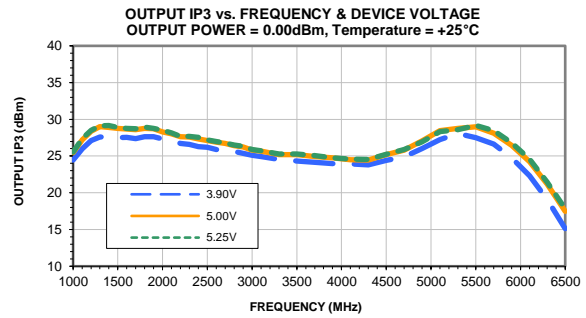
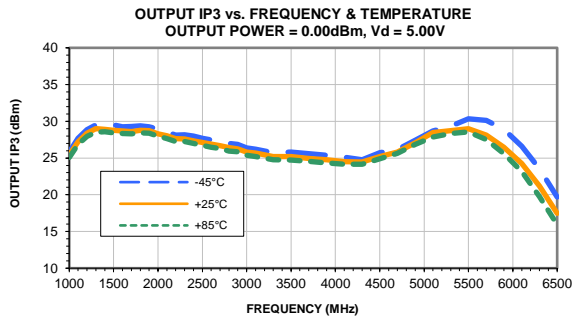

Typical Performance Curves

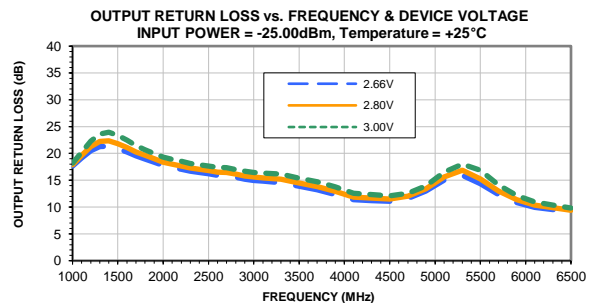
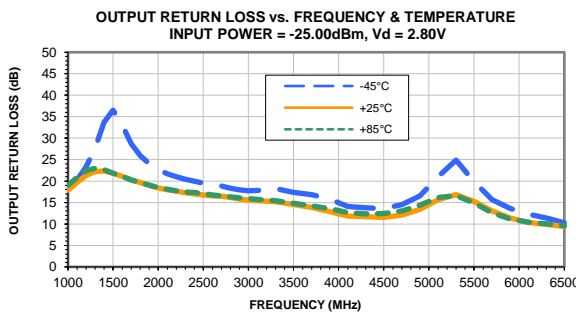
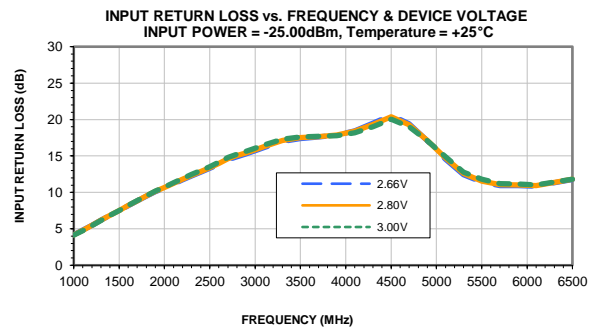
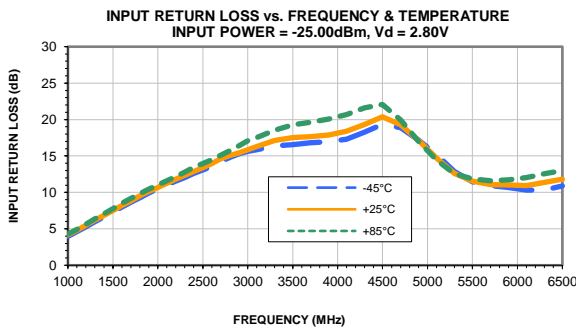
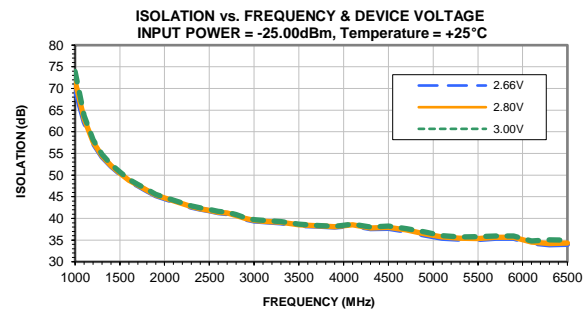
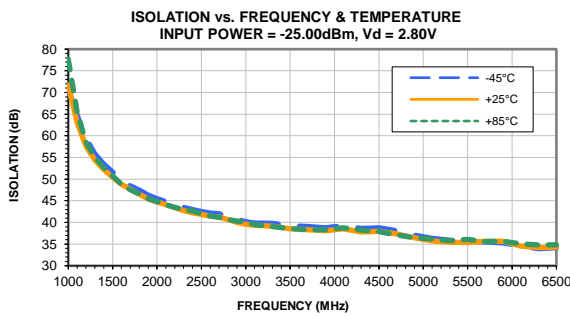
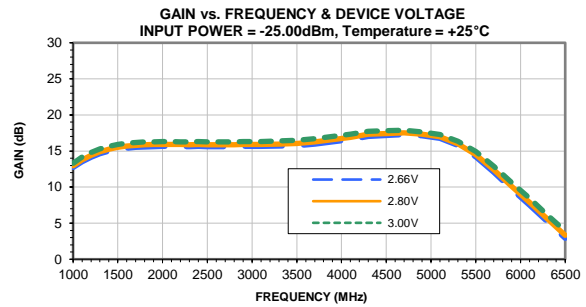
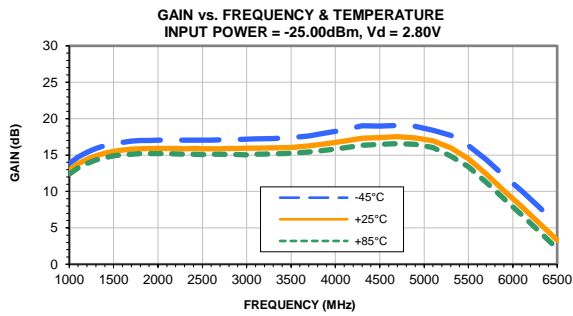

Typical Performance Curves

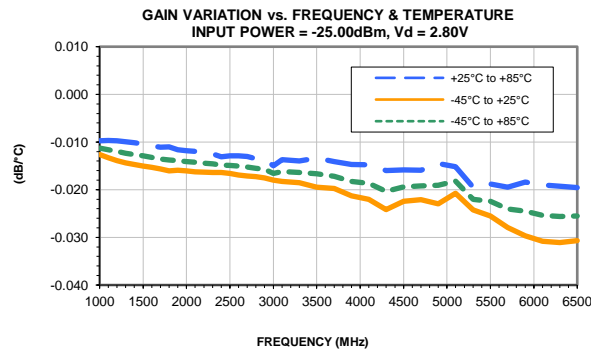
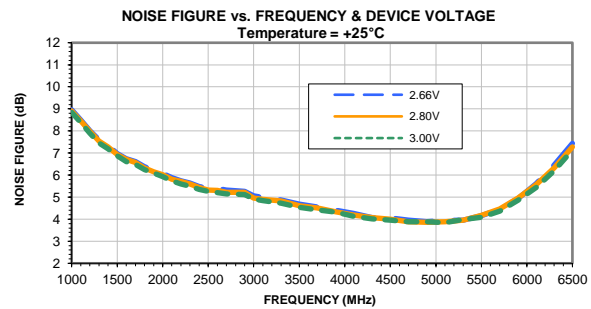
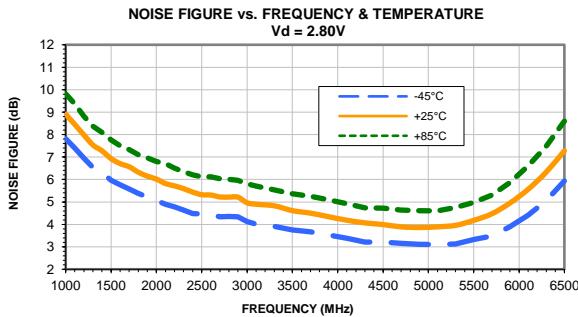
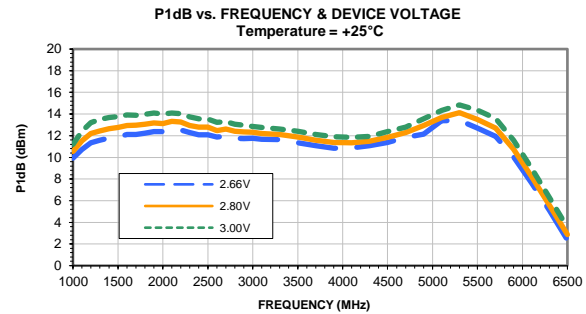
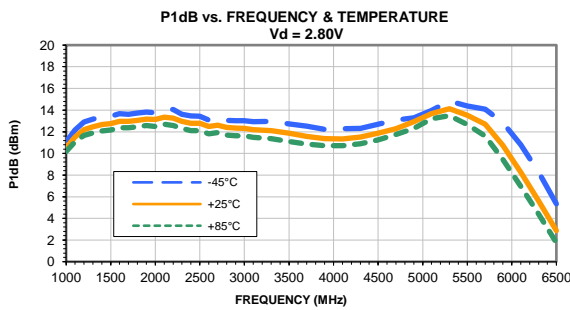
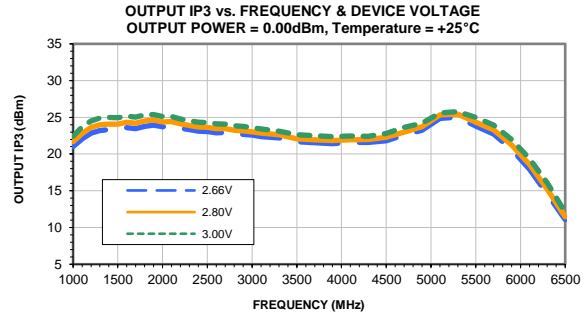
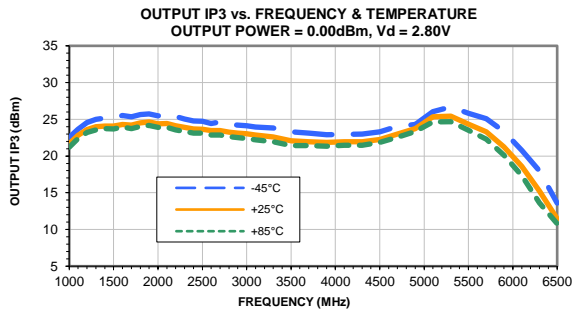

Outline Dimensions

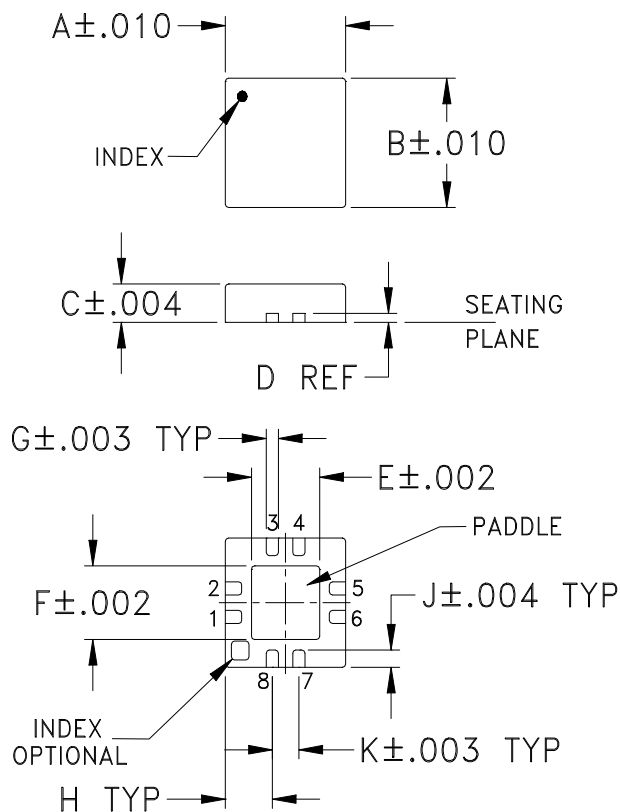

PCB Land Pattern

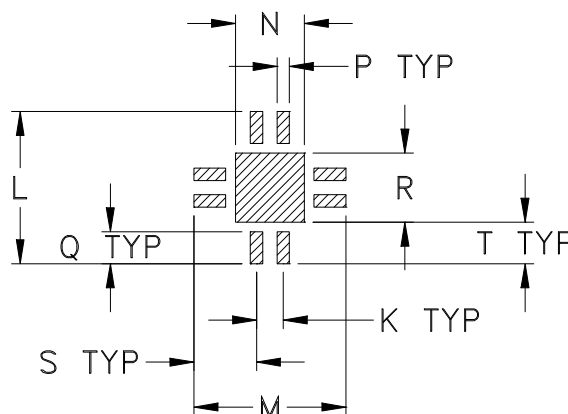

Suggested Layout,
Tolerance to be within $\pm.002$

CASE #	A	B	C	D	E	F	G	H	J	K	L	M	N
DQ849	.118 (3.00)	.118 (3.00)	.035 (0.89)	.008 (0.20)	.067 (1.70)	.067 (1.70)	.012 (0.30)	.046 (1.17)	.016 (0.41)	.026 (0.66)	.148 (3.76)	.148 (3.76)	.067 (1.70)

CASE #	P	Q	R	S	T	WT. GRAM
DQ849	.012 (0.30)	.031 (0.79)	.067 (1.70)	.061 (1.55)	.041 (1.04)	.02

Dimensions are in inches (mm). Tolerances: 2Pl. $\pm.01$; 3 Pl. $\pm.004$

Notes:

- Case material: Plastic.
- Termination finish:
 For RoHS Case Styles: Tin-Silver alloy plate over Nickel barrier or Matte-Tin plated. All models, (+) suffix. See Data sheet.
 For RoHS-5 Case Styles: Tin-Lead plate. All models. no (+) suffix.



INTERNET <http://www.minicircuits.com>

P.O. Box 350166, Brooklyn, New York 11235-0003 (718) 934-4500 Fax (718) 332-4661

Distribution Centers NORTH AMERICA 800-654-7949 • 417-335-5935 • Fax 417-335-5945 • EUROPE 44-1252-832600 • Fax 44-1252-837010

Mini-Circuits ISO 9001 & ISO 14001 Certified

Tape & Reel Packaging TR-F104

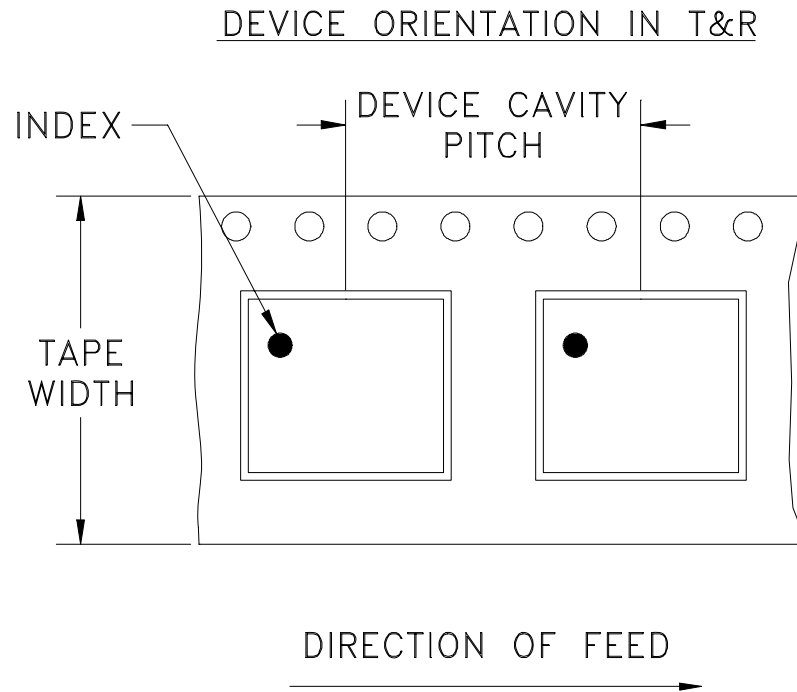

Tape Width, mm	Device Cavity Pitch, mm	Reel Size, inches	Devices per Reel	
8	4	7	Small quantity standards (see note)	20
				50
				100
				200
				500
				1000
		7	Standard	2000

Note: Please Consult individual model data sheet to determine device per reel availability.

Mini-Circuits carrier tape materials provide protection from ESD (Electro-Static Discharge) during handling and transportation. Tapes are static dissipative and comply with industry standards EIA-481/EIA-541.

Go to: www.minicircuits.com/pages/pdfs/tape.pdf



INTERNET <http://www.minicircuits.com>

P.O. Box 350166, Brooklyn, New York 11235-0003 (718) 934-4500 Fax (718) 332-4661

Distribution Centers NORTH AMERICA 800-654-7949 • 417-335-5935 • Fax 417-335-5945 • EUROPE 44-1252-832600 • Fax 44-1252-837010

Mini-Circuits ISO 9001 & ISO 14001 Certified

THIRD ANGLE PROJECTION

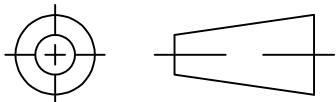

REVISIONS

REV	ECN No.	DESCRIPTION	DATE	DR	AUTH
OR	M82272	NEW RELEASE	08/05/02	GF	DJ
A	M82598	MODIFIED LAYOUT	08/12/02	GF	MM
B	M102713	ADDED "...WITH SMOBC"	01/14/06	GF	IL
C	ECO-003400	REMOVED COMP. VALUE, ADDED NOTE REF. TO EVAL. BOARD	07/23/20	ITG	IL

SUGGESTED MOUNTING CONFIGURATION
FOR DQ849 CASE STYLE

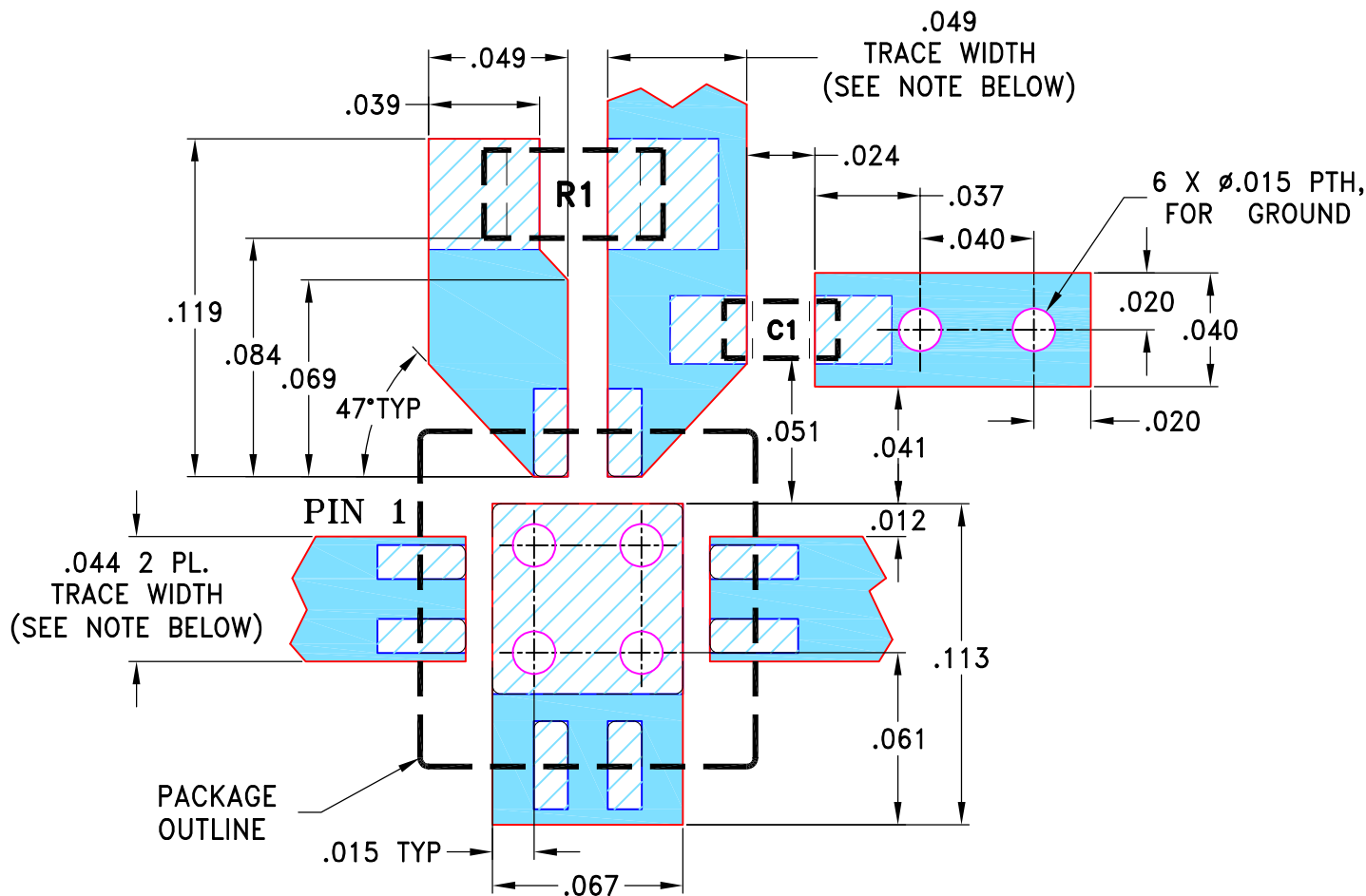

RESISTOR R1: 0603 SIZE
CAPACITOR C1: 0402 SIZE

NOTES:

1. LINE WIDTH IS SHOWN FOR ROGERS R04350B WITH DIELECTRIC THICKNESS $.020 \pm .0015$ ";
COPPER: 1/2 OZ. FOR OTHER MATERIALS LINE WIDTH MAY NEED TO BE MODIFIED.
2. FOR "R1" & "C1" VALUES REFER TO THE CORRESPONDING EVALUATION BOARD TB-186-XX+.
3. BOTTOM SIDE OF THE PCB IS CONTINUOUS GROUND PLANE.

DENOTES PCB COPPER LAYOUT WITH SMOBC (SOLDER MASK OVER BARE COPPER)

DENOTES COPPER LAND PATTERN FREE OF SOLDER MASK

UNLESS OTHERWISE SPECIFIED	INITIALS	DATE
DIMENSIONS ARE IN INCHES	DRAWN GF	07/19/02
TOLERANCES ON:	CHECKED LC	08/01/02
2 PL DECIMALS ±	APPROVED DJ	08/05/02
3 PL DECIMALS ± .005		
ANGLES ±		
FRACTIONS ±		



Mini-Circuits® 13 Neptune Avenue
Brooklyn NY 11235

PL, DQ849, TB-186-XX+

Mini-Circuits®
THIS DOCUMENT AND ITS CONTENTS ARE THE PROPERTY OF MINI-CIRCUITS.
EXCEPT FOR USE EXPRESSLY GRANTED, IN WRITING, TO ITS VENDORS, VENDEE
AND THE UNITED STATES GOVERNMENT, MINI-CIRCUITS RESERVES ALL PROPRIETARY
DESIGN, USE, MANUFACTURING AND REPRODUCTION RIGHTS THERETO.
THESE CONTENTS SHALL NOT BE USED, DUPLICATED OR DISCLOSED TO ANY OUTSIDE
PARTY, IN WHOLE OR IN PART, WITHOUT WRITTEN PERMISSION OF MINI-CIRCUITS.

SIZE	CODE IDENT	DRAWING NO:	REV:
A	15542	98-PL-078	C
FILE:	98PL078	SCALE:	15:1
		SHEET:	1 OF 1

Evaluation Board and Circuit

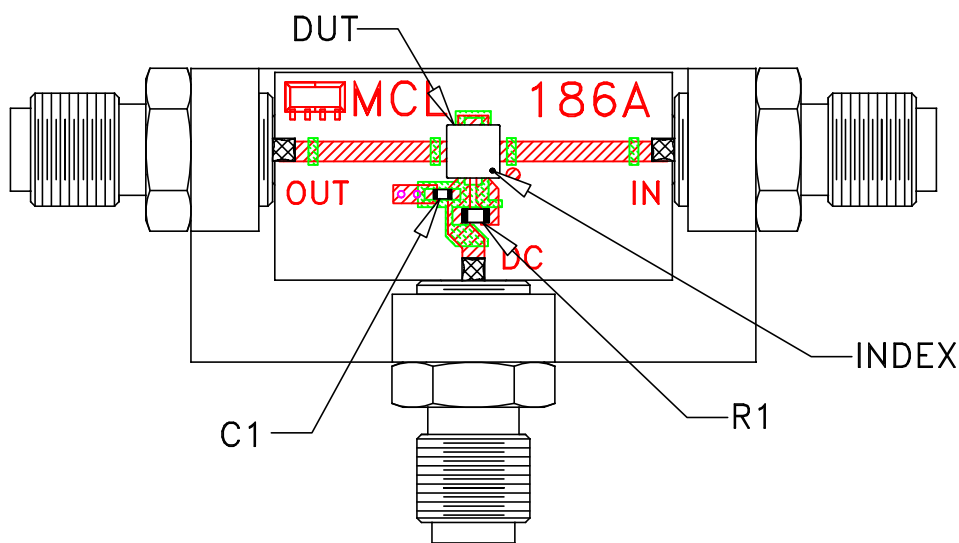

TB-186-7A+

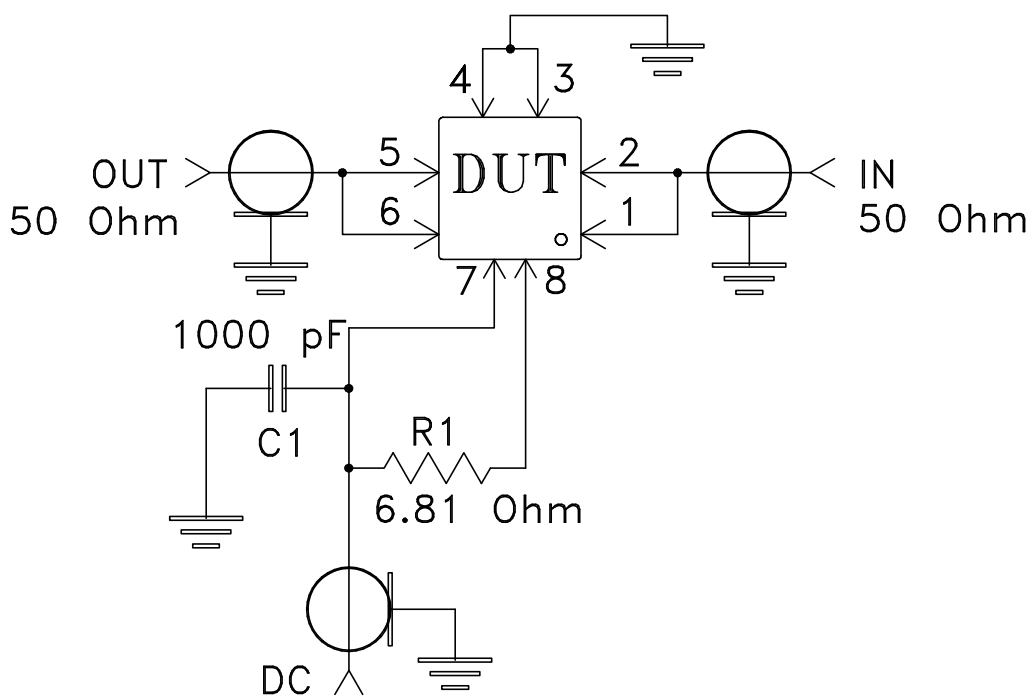

Schematic Diagram

Notes:

1. SMA Female connectors.
2. PCB Material: Rogers R04350 or equivalent, Dielectric Constant=3.5, Thickness=.020 inch.
3. Pins 1 and 6 have no internal connecton.
4. Paddle underneath DUT must be grounded.

 **Mini-Circuits®**

All Mini-Circuits products are manufactured under exacting quality assurance and control standards, and are capable of meeting published specifications after being subjected to any or all of the following physical and environmental test.

Specification	Test/Inspection Condition	Reference/Spec
Operating Temperature	-40° to 85° C or -45° to 85° C or -55° to 105° C or -40° to 105° C or -40° to 95° C Ambient Environment	Individual Model Data Sheet
Storage Temperature	-55° to 100° C or -65° to 150° Ambient Environment	Individual Model Data Sheet
HTOL	1000 hours at 125°C	MIL-STD-883, Method 1005, Condition B
Thermal Shock	-55° to 100°C, 100 cycles	MIL-STD-202, Method 107, Condition A-3, except +100°C
Mechanical Shock	1.5Kg, 0.5 ms, 5 shock pulses, Y1 direction only	MIL-STD-883, Method 2002, Condition B, except Y1 direction only
Vibration (Variable Frequency)	50g peak	MIL-STD-883, Method 2007, Condition B
Autoclave	15 psig, 100% RH, 121°C, 96 hours	JESD22-A102, Condition C
HAST	130°C, 85% RH, 96 hours	JESD22-A110
Solderability	10X Magnification	J-STD-002, Para 4.2.5, Test S, 95% Coverage
Solder Reflow Heat	Sn-Pb Eutetic Process: 240°C peak Pb-Free Process: 260°C peak	J-STD-020, Table 4-1, 4-2 and 5-2; Figure 5-1
Moisture Sensitivity: Level 1	Bake at 125°C for 24 hours Soak at 85°C/85% RH for 168 hours, Reflow 3 cycles at 260°C peak	J-STD-020

All Mini-Circuits products are manufactured under exacting quality assurance and control standards, and are capable of meeting published specifications after being subjected to any or all of the following physical and environmental test.

Specification	Test/Inspection Condition	Reference/Spec
Marking Resistance to Solvents	Isopropyl alcohol + mineral spirits at 25°C; terpene defluxer at 25°C; distilled water + proylene glycol monomethyl ether + monoethanolamine at 63°C to 70°C	MIL-STD-202, Method 215