

## Surface Mount

# Dual Matched MMIC Amplifier

## DC-1 GHz

### Product Features

- Two matched 50-ohm amplifiers in one package
- InGaP HBT IF and RF amplifier
- Frequency range DC to 1 GHz
- High gain, 25.1 dB typ. at 0.1 GHz
- Up to +19 dBm typ. output power at 0.1 GHz
- High IP3, +36 dBm at 0.1 GHz
- Low noise figure, 2.7 dB typ.
- Low thermal resistance
- Transient protected
- Useable as balanced and push pull amplifier
- Protected by US Patent 6,943,629

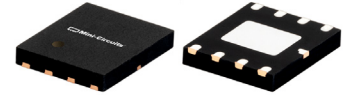

Generic photo used for illustration purposes only

## MERA-7456+

CASE STYLE: DL1020

**+RoHS Compliant**

The +Suffix identifies RoHS Compliance. See our web site for RoHS Compliance methodologies and qualifications

### Typical Applications

- Cellular
- CATV
- UHF/VHF communications
- Receivers & transmitters

### General Description

MERA-7456+ is a dual matched wideband amplifier offering high dynamic range. It has repeatable performance from lot to lot. It is enclosed in a 6.0 x 4.9 mm MCLP plastic package. MERA-7456+ uses Darlington configuration and is fabricated using InGaP HBT technology. Expected MTBF at 85°C case temperature is 300 years for the entire device (A1 and A2).

### simplified schematic (each of A1, A2) and pin description

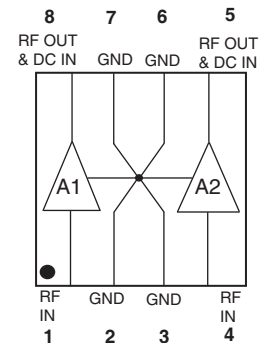
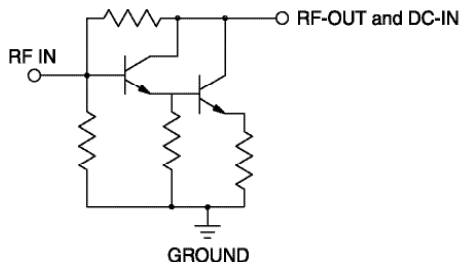

Function	Pin Number	Description
RF IN, A1	1	RF input pin. This pin requires the use of an external DC blocking capacitor chosen for the frequency of operation.
RF-OUT and DC-IN, A1	8	RF output and bias pin. DC voltage is present on this pin; therefore a DC blocking capacitor is necessary for proper operation. An RF choke is needed to feed DC bias without loss of RF signal due to the bias connection, as shown in "Recommended Application Circuit".
RF IN, A2	4	RF input pin. This pin requires the use of an external DC blocking capacitor chosen for the frequency of operation.
RF-OUT and DC-IN, A2	5	RF output and bias pin. DC voltage is present on this pin; therefore a DC blocking capacitor is necessary for proper operation. An RF choke is needed to feed DC bias without loss of RF signal due to the bias connection, as shown in "Recommended Application Circuit".
GND	2,3,6,7 & paddle	Connections to ground. Use via holes as shown in "Suggested Layout for PCB Design" to reduce ground path inductance for best performance.

#### Notes

- A. Performance and quality attributes and conditions not expressly stated in this specification document are intended to be excluded and do not form a part of this specification document.  
 B. Electrical specifications and performance data contained in this specification document are based on Mini-Circuit's applicable established test performance criteria and measurement instructions.  
 C. The parts covered by this specification document are subject to Mini-Circuits standard limited warranty and terms and conditions (collectively, "Standard Terms"); Purchasers of this part are entitled to the rights and benefits contained therein. For a full statement of the Standard Terms and the exclusive rights and remedies thereunder, please visit Mini-Circuits' website at [www.minicircuits.com/MCLStore/terms.jsp](http://www.minicircuits.com/MCLStore/terms.jsp)



**Electrical Specifications at 25°C and 80mA, unless noted**

(Specifications (other than Matching) are for each of the two matched amplifiers in the package.)

Parameter		Min.	Typ.	Max.	Units
Frequency Range*		DC		1	GHz
Gain	f=0.1 GHz	—	25.1	—	dB
	f=1 GHz	20	22.5	—	
	f=2 GHz	—	18.6	—	
	f=3 GHz	—	14.2	—	
	f=4 GHz	—	9.4	—	
Input Return Loss	f=DC to 1 GHz		17.5		dB
Output Return Loss	f=DC to 1 GHz		9.5		dB
Output Power @ 1 dB compression	f=0.1 GHz	18	19	—	dBm
	f=1 GHz	—	18.2	—	
	f=2 GHz	—	14.4	—	
Output IP3	f=0.1 GHz		36		dBm
	f=0.5 GHz		35		
	f=1 GHz		32		
Noise Figure	f=DC to 1 GHz		2.7		dB
Matching between A1, A2 <sup>2</sup>					
Amplitude Unbalance	f=DC to 1 GHz	—	0.1	0.3	dB
	f=1 to 4 GHz	—	0.1	—	
Phase Unbalance	f=DC to 1 GHz		0.6		deg.
	f=1 to 4 GHz		1.0		
Recommended Device Operating Current			80		mA
Device Operating Voltage		4.3	4.8	5.3	V
Device Voltage Variation vs. Temperature at 80 mA			-3.1		mV/°C
Device Voltage Variation vs. Current at 25°C			2.8		mV/mA
Thermal Resistance, junction-to-case <sup>1</sup> , A1 or A2			120		°C/W

\*Guaranteed specification DC-1 GHz. Low frequency cut off determined by external coupling capacitors.

**Absolute Maximum Ratings for each Amplifier**

Parameter	Ratings
Operating Temperature	-45°C to 85°C
Storage Temperature	-55°C to 100°C
Operating Current	130mA
Power Dissipation	700mW
Input Power	10dBm

Note: Permanent damage may occur if any of these limits are exceeded.  
These ratings are not intended for continuous normal operation.

<sup>1</sup>Case is defined as ground paddle. See application note AN-60-032 for adequate heat sinking of paddle.<sup>2</sup>For test method, see application note AN-60-032.**Notes**

- A. Performance and quality attributes and conditions not expressly stated in this specification document are intended to be excluded and do not form a part of this specification document.  
 B. Electrical specifications and performance data contained in this specification document are based on Mini-Circuit's applicable established test performance criteria and measurement instructions.  
 C. The parts covered by this specification document are subject to Mini-Circuits standard limited warranty and terms and conditions (collectively, "Standard Terms"); Purchasers of this part are entitled to the rights and benefits contained therein. For a full statement of the Standard Terms and the exclusive rights and remedies thereunder, please visit Mini-Circuits' website at [www.minicircuits.com/MCLStore/terms.jsp](http://www.minicircuits.com/MCLStore/terms.jsp)



**Product Marking**

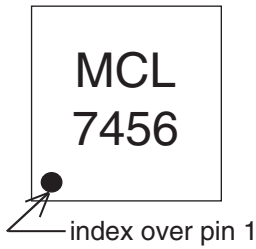

Markings in addition to model number designation may appear for internal quality control purposes.

**Additional Detailed Technical Information**

Additional information is available on our web site. To access this information enter the model number on our web site home page.

**Performance data, graphs, s-parameter data set (.zip file)**

**Case Style: DL1020**

Plastic package, exposed paddle, lead finish: Matte-Tin

**Tape & Reel: F68**

**Standard quantities available on reel** 7" reels with 20, 50, 100, 200, 500 or 1K devices.  
13" reels with 2000, 3000, 4000 devices.

**Suggested Layout for PCB Design: PL-164**

**Evaluation Board: TB-293+**

**Environmental Ratings: ENV08T2**

**Recommended Application and Biasing Circuit**

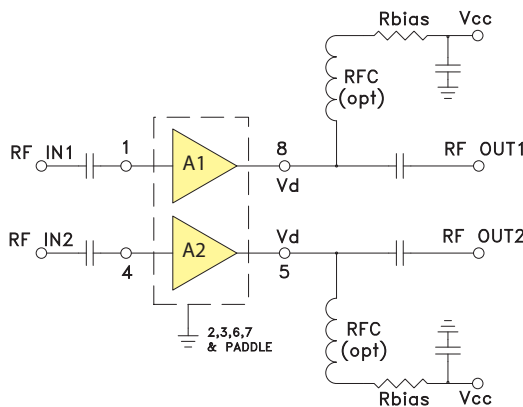

R BIAS	
Vcc	"1%" Res. Values (ohms) for Optimum Biasing
7	28.7
8	41.2
9	53.6
10	66.5
11	78.7
12	90.9
13	102
14	115
15	127

**Notes**

- A. Performance and quality attributes and conditions not expressly stated in this specification document are intended to be excluded and do not form a part of this specification document.
- B. Electrical specifications and performance data contained in this specification document are based on Mini-Circuit's applicable established test performance criteria and measurement instructions.
- C. The parts covered by this specification document are subject to Mini-Circuits' standard limited warranty and terms and conditions (collectively, "Standard Terms"); Purchasers of this part are entitled to the rights and benefits contained therein. For a full statement of the Standard Terms and the exclusive rights and remedies thereunder, please visit Mini-Circuits' website at [www.minicircuits.com/MCLStore/terms.jsp](http://www.minicircuits.com/MCLStore/terms.jsp)



**ESD Rating**

Human Body Model (HBM): Class 1C (1000 v to < 2000 v) in accordance with ANSI/ESD STM 5.1 - 2001

Machine Model (MM): Class M2 (100 v to < 200 v) in accordance with ESD STM 5.2-1999

**MSL Rating**

Moisture Sensitivity: MSL1 in accordance with IPC/JEDECJ-STD-020C

No.	Test Required	Condition	Standard	Quantity
1	Visual Inspection	Low Power Microscope Magnification 40x	MIP-IN-0003 (MCT spec)	114 units
2	Electrical Test	Room Temperature	SCD (MCL spec)	114 units
3	SAM Analysis	Less than 10% growth in term of delamination	J-Std-020C (Jedec Standard)	114 units
4	Moisture Sensitivity Level 1	Bake at 125°C for 24 hours Soak at 85°C/85%RH for 168 hours Reflow 3 cycles at 250°C peak	J-Std-020C (Jedec Standard)	114 units

**MSL Test Flow Chart**

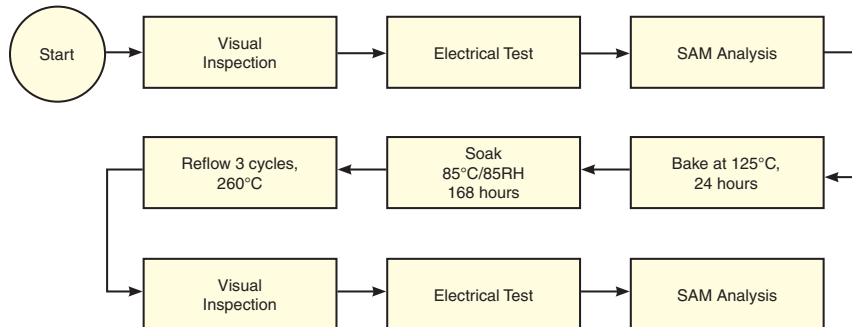

**Notes**

- A. Performance and quality attributes and conditions not expressly stated in this specification document are intended to be excluded and do not form a part of this specification document.
- B. Electrical specifications and performance data contained in this specification document are based on Mini-Circuit's applicable established test performance criteria and measurement instructions.
- C. The parts covered by this specification document are subject to Mini-Circuits standard limited warranty and terms and conditions (collectively, "Standard Terms"); Purchasers of this part are entitled to the rights and benefits contained therein. For a full statement of the Standard Terms and the exclusive rights and remedies thereunder, please visit Mini-Circuits' website at [www.minicircuits.com/MCLStore/terms.jsp](http://www.minicircuits.com/MCLStore/terms.jsp)



## Typical Performance Data

**NOTE: Use PDF Bookmarks to view DATA at required conditions  
or to view GRAPHS.**

**Definitions:**

Input Return Loss = -S11 (dB)

Gain(Power Gain) = S21 (dB)

Reverse Isolation = -S12 (dB)

Output Return Loss = -S22 (dB)

TEST CONDITIONS: I<sub>cc</sub> = 80mA, V<sub>d</sub>=4.82V @Temperature = +25degC

FREQ	Gain	Isolation	Input Return Loss	Output Return Loss	Stability		FREQ	IP3 Output	1dB Comp. Output	Noise Figure
(MHz)	(dB)	(dB)	(dB)	(dB)	K	Delta	(MHz)	(dBm)	(dBm)	(dB)
20	25.07	28.64	25.86	16.71	1.08	0.67	20	36.82	19.75	2.57
30	25.10	27.60	27.14	17.13	1.03	0.76	30	36.52	19.90	2.60
50	25.06	28.06	26.31	16.94	1.05	0.71	50	36.30	20.03	2.59
100	24.97	28.06	25.37	16.48	1.05	0.71	100	36.29	19.99	2.76
150	24.89	28.13	24.45	15.97	1.06	0.70	200	36.09	19.91	2.62
200	24.80	28.10	23.42	15.23	1.05	0.69	300	35.71	19.50	2.89
250	24.68	27.84	22.38	14.58	1.05	0.70	400	35.38	19.83	2.72
300	24.57	27.94	21.48	13.94	1.05	0.69	500	35.00	19.18	2.84
350	24.46	27.91	20.90	13.44	1.05	0.68	600	34.64	19.53	2.75
400	24.36	27.77	20.29	12.88	1.04	0.68	700	34.17	19.16	2.92
450	24.24	27.78	19.68	12.35	1.04	0.67	800	33.66	18.72	2.76
500	24.12	27.71	18.98	11.79	1.04	0.67	900	33.12	18.76	2.81
600	23.84	27.72	17.93	10.95	1.04	0.65	1000	32.38	17.98	2.72
700	23.57	27.57	17.11	10.07	1.03	0.65	1100	31.82	18.16	2.79
800	23.28	27.45	16.15	9.31	1.02	0.64	1200	31.39	17.60	2.80
900	22.97	27.35	15.52	8.63	1.02	0.63	1300	30.88	17.38	2.81
1000	22.62	27.25	14.79	8.03	1.02	0.62	1400	30.41	17.16	2.90
1100	22.28	27.21	14.14	7.49	1.01	0.61	1500	30.07	16.19	2.95
1200	21.94	27.00	13.63	7.00	1.00	0.60	1600	30.07	16.21	2.93
1300	21.55	26.93	13.10	6.60	1.01	0.59	1700	29.77	15.16	2.80
1400	21.19	26.91	12.54	6.18	1.01	0.58	1800	29.26	15.28	2.97
1500	20.81	26.77	12.12	5.84	1.00	0.57	1900	28.63	14.93	2.88
1600	20.41	26.73	11.78	5.60	1.01	0.56	2000	27.97	13.71	2.95
1700	20.05	26.61	11.36	5.31	1.01	0.56	2100	27.35	14.23	2.78
1800	19.68	26.53	10.99	5.07	1.01	0.55	2200	26.95	13.14	2.99
2000	18.90	26.32	10.30	4.64	1.01	0.54	2300	26.91	13.16	2.81
2200	18.13	26.24	9.65	4.30	1.02	0.53	2400	26.98	13.00	2.93
2400	17.36	26.10	9.16	4.06	1.04	0.52	2500	26.80	12.15	2.86
2600	16.60	26.06	8.57	3.84	1.06	0.52	2600	26.28	12.49	3.09
2800	15.85	25.96	8.10	3.69	1.09	0.51	2700	25.66	11.28	2.92
3000	15.07	25.86	7.46	3.48	1.11	0.52	2800	25.04	11.81	3.14
3200	14.29	25.80	6.88	3.35	1.14	0.52	2900	24.95	11.65	3.02
3400	13.55	25.77	6.32	3.17	1.15	0.53	3000	25.07	10.37	3.03
3600	12.74	25.98	5.80	3.04	1.20	0.53	3100	25.13	11.09	3.05
4000	11.02	26.25	4.81	2.79	1.28	0.55	3200	24.83	9.81	3.07
4500	8.89	26.80	3.82	2.50	1.38	0.57	3300	24.44	10.46	3.15
5000	6.68	27.45	3.10	2.24	1.50	0.60	3400	24.03	9.92	3.45
5500	4.35	28.36	2.61	1.99	1.70	0.63	3600	23.68	9.84	3.44
6000	2.04	29.17	2.26	1.77	1.90	0.65	3800	23.56	9.35	3.55
7000	-2.47	30.89	1.87	1.46	2.68	0.69	4000	23.02	8.13	3.56

REV. X1

MERA-7456+

120125

Page 1 of 11



IF/RF MICROWAVE COMPONENTS • ISO 9001 ISO 14001 AS 9100 CERTIFIED RoHS compliant

P.O. Box 350166, Brooklyn, New York 11235-0003 (718) 934-4500 Fax (718) 332-4661



The Design Engineers Search Engine finds the model you need, Instantly • For detailed performance specs & shopping online see



# MMIC Amplifier

# MERA-7456+

## Typical Performance Data

### Definitions:

Input Return Loss = -S11 (dB)

Gain(Power Gain) = S21 (dB)

Reverse Isolation = -S12 (dB)

Output Return Loss = -S22 (dB)

TEST CONDITIONS: Icc = 64mA, Vd=4.77V @Temperature = +25degC

FREQ	Gain	Isolation	Input Return Loss	Output Return Loss	Stability		FREQ	IP3 Output	1dB Comp. Output	Noise Figure
(MHz)	(dB)	(dB)	(dB)	(dB)	K	Delta	(MHz)	(dBm)	(dBm)	(dB)
20	24.83	28.25	32.36	18.35	1.07	0.68	20	33.65	18.74	2.56
30	24.86	27.73	34.99	19.10	1.05	0.72	30	33.41	18.66	2.56
50	24.81	27.67	32.21	18.83	1.05	0.72	50	33.25	18.70	2.54
100	24.73	27.90	29.76	18.24	1.06	0.70	100	33.29	18.66	2.68
150	24.65	27.58	27.82	17.42	1.05	0.72	200	33.30	18.74	2.59
200	24.57	27.71	25.87	16.58	1.05	0.70	300	33.16	18.40	2.83
250	24.45	27.82	24.53	15.71	1.06	0.68	400	33.09	18.53	2.70
300	24.35	27.76	23.20	15.00	1.05	0.68	500	32.92	18.20	2.77
350	24.24	27.65	22.47	14.39	1.05	0.68	600	32.77	18.25	2.70
400	24.14	27.50	21.83	13.71	1.04	0.68	700	32.49	18.12	2.82
450	24.03	27.45	20.99	13.13	1.04	0.68	800	32.25	17.79	2.73
500	23.91	27.49	20.17	12.48	1.04	0.67	900	31.98	17.99	2.74
600	23.65	27.33	18.95	11.55	1.03	0.66	1000	31.50	17.46	2.68
700	23.39	27.31	17.94	10.57	1.03	0.64	1100	31.12	17.57	2.72
800	23.11	27.08	16.86	9.73	1.02	0.64	1200	30.76	17.20	2.76
900	22.81	27.10	16.14	9.02	1.02	0.62	1300	30.26	16.90	2.73
1000	22.47	26.89	15.33	8.37	1.01	0.62	1400	29.75	16.77	2.84
1100	22.14	26.80	14.62	7.78	1.00	0.61	1500	29.46	15.77	2.87
1200	21.81	26.67	14.00	7.26	1.00	0.60	1600	29.46	15.78	2.88
1300	21.43	26.67	13.46	6.82	1.00	0.59	1700	29.21	14.76	2.74
1400	21.07	26.50	12.87	6.39	0.99	0.58	1800	28.74	14.81	2.89
1500	20.70	26.40	12.38	6.04	0.99	0.58	1900	28.07	14.49	2.81
1600	20.31	26.39	12.02	5.78	1.00	0.56	2000	27.41	13.27	2.88
1700	19.94	26.24	11.57	5.46	0.99	0.56	2100	26.78	13.77	2.70
1800	19.58	26.10	11.21	5.20	0.99	0.56	2200	26.41	12.72	2.91
2000	18.80	26.02	10.48	4.78	1.00	0.54	2300	26.38	12.69	2.72
2200	18.04	25.88	9.81	4.41	1.01	0.53	2400	26.42	12.55	2.85
2400	17.27	25.78	9.29	4.17	1.03	0.52	2500	26.29	11.70	2.80
2600	16.52	25.72	8.68	3.94	1.05	0.51	2600	25.74	12.03	2.99
2800	15.76	25.61	8.18	3.78	1.08	0.51	2700	25.14	10.83	2.86
3000	14.99	25.56	7.54	3.56	1.09	0.51	2800	24.54	11.35	3.05
3200	14.20	25.47	6.93	3.44	1.12	0.52	2900	24.45	11.23	2.92
3400	13.46	25.49	6.37	3.25	1.14	0.52	3000	24.56	9.94	2.90
3600	12.65	25.65	5.84	3.13	1.18	0.53	3100	24.62	10.65	2.93
4000	10.94	25.89	4.85	2.88	1.26	0.54	3200	24.35	9.43	2.94
4500	8.79	26.55	3.84	2.59	1.38	0.57	3300	23.95	9.99	3.03
5000	6.58	27.22	3.12	2.32	1.50	0.59	3400	23.53	9.51	3.32
5500	4.26	28.15	2.62	2.06	1.70	0.62	3600	23.20	9.42	3.31
6000	1.94	29.02	2.27	1.83	1.92	0.65	3800	23.15	8.94	3.42
7000	-2.55	30.80	1.88	1.51	2.74	0.69	4000	22.59	7.72	3.44

REV. X1

MERA-7456+

120125

Page 2 of 11



IF/RF MICROWAVE COMPONENTS • ISO 9001 ISO 14001 AS 9100 CERTIFIED • RoHS compliant

P.O. Box 350166, Brooklyn, New York 11235-0003 (718) 934-4500 Fax (718) 332-4661



The Design Engineers Search Engine finds the model you need, Instantly • For detailed performance specs & shopping online see



# MMIC Amplifier

# MERA-7456+

## Typical Performance Data

### Definitions:

Input Return Loss = -S11 (dB)

Gain(Power Gain) = S21 (dB)

Reverse Isolation = -S12 (dB)

Output Return Loss = -S22 (dB)

TEST CONDITIONS: Icc = 96mA, Vd=4.87V @Temperature = +25degC

FREQ	Gain	Isolation	Input Return Loss	Output Return Loss	Stability		FREQ	IP3 Output	1dB Comp. Output	Noise Figure
(MHz)	(dB)	(dB)	(dB)	(dB)	K	Delta	(MHz)	(dBm)	(dBm)	(dB)
20	25.22	28.25	24.36	15.73	1.05	0.71	20	39.18	19.92	2.63
30	25.25	27.80	24.93	16.02	1.03	0.75	30	38.83	20.16	2.63
50	25.20	28.33	23.91	15.96	1.05	0.71	50	38.55	20.06	2.63
100	25.11	28.23	23.34	15.54	1.05	0.71	100	38.42	20.22	2.83
150	25.03	28.13	22.53	15.11	1.05	0.71	150	37.90	20.26	2.65
200	24.94	28.26	21.84	14.52	1.05	0.69	200	37.23	19.93	2.96
250	24.81	28.24	21.08	13.91	1.05	0.69	300	36.70	20.43	2.79
300	24.70	28.20	20.27	13.34	1.05	0.68	400	36.10	19.48	2.92
350	24.59	28.03	19.78	12.88	1.05	0.69	500	35.55	20.07	2.79
400	24.48	28.07	19.39	12.39	1.05	0.67	600	34.96	19.45	2.99
450	24.37	27.97	18.86	11.91	1.04	0.68	700	34.34	19.00	2.81
500	24.24	27.87	18.22	11.40	1.04	0.67	800	33.67	19.01	2.88
600	23.95	27.81	17.23	10.59	1.04	0.66	900	32.89	18.16	2.79
700	23.68	27.75	16.52	9.76	1.03	0.65	1000	32.28	18.42	2.87
800	23.38	27.65	15.68	9.05	1.03	0.64	1100	31.82	17.81	2.89
900	23.06	27.61	15.09	8.41	1.03	0.63	1200	31.32	17.62	2.87
1000	22.71	27.45	14.42	7.83	1.02	0.62	1300	30.85	17.41	2.95
1100	22.37	27.33	13.83	7.31	1.01	0.61	1400	30.51	16.46	3.00
1200	22.02	27.22	13.30	6.85	1.01	0.60	1500	30.50	16.54	2.99
1300	21.63	27.13	12.82	6.44	1.01	0.59	1600	30.19	15.45	2.89
1400	21.27	27.11	12.29	6.05	1.01	0.58	1700	29.68	15.62	3.03
1500	20.88	27.00	11.88	5.74	1.01	0.57	1800	29.06	15.28	2.95
1600	20.49	26.98	11.58	5.50	1.02	0.56	1900	28.41	14.10	3.01
1700	20.12	26.81	11.17	5.21	1.01	0.56	2000	27.79	14.61	2.86
1800	19.75	26.73	10.83	4.98	1.01	0.55	2100	27.40	13.50	3.06
2000	18.97	26.57	10.16	4.58	1.02	0.54	2200	27.40	13.55	2.89
2200	18.20	26.38	9.51	4.24	1.03	0.54	2300	27.35	13.38	3.02
2400	17.43	26.34	9.06	4.01	1.05	0.53	2400	27.23	12.54	2.96
2600	16.68	26.27	8.48	3.79	1.07	0.52	2500	26.70	12.88	3.16
2800	15.92	26.14	8.02	3.64	1.10	0.52	2600	26.08	11.64	3.02
3000	15.14	26.01	7.41	3.42	1.11	0.52	2700	25.47	12.21	3.23
3200	14.36	26.02	6.83	3.29	1.15	0.52	2800	25.37	12.01	3.09
3400	13.63	25.96	6.28	3.10	1.15	0.53	2900	25.46	10.74	3.12
3600	12.82	26.11	5.75	2.98	1.20	0.54	3000	25.26	10.12	3.17
4000	11.10	26.38	4.78	2.73	1.28	0.55	3100	24.86	10.81	3.25
4500	8.97	26.92	3.80	2.43	1.38	0.58	3200	24.43	10.27	3.54
5000	6.76	27.61	3.08	2.18	1.50	0.61	3300	24.10	10.22	3.57
5500	4.42	28.49	2.59	1.93	1.69	0.63	3400	23.99	9.73	3.68
6000	2.10	29.37	2.25	1.72	1.91	0.66	3800	23.49	8.48	3.70
7000	-2.41	30.98	1.85	1.41	2.64	0.70	4000			

REV. X1

MERA-7456+

120125

Page 3 of 11



IF/RF MICROWAVE COMPONENTS • ISO 9001 ISO 14001 AS 9100 CERTIFIED • RoHS compliant

P.O. Box 350166, Brooklyn, New York 11235-0003 (718) 934-4500 Fax (718) 332-4661



The Design Engineers Search Engine finds the model you need, Instantly • For detailed performance specs & shopping online see





# MMIC Amplifier

# MERA-7456+

## Typical Performance Data

### Definitions:

Input Return Loss = -S11 (dB)

Gain(Power Gain) = S21 (dB)

Reverse Isolation = -S12 (dB)

Output Return Loss = -S22 (dB)

TEST CONDITIONS: Icc = 80mA, Vd=5.08V @Temperature = -45degC

FREQ	Gain	Isolation	Input Return Loss	Output Return Loss	Stability		FREQ	IP3 Output	1dB Comp. Output	Noise Figure
(MHz)	(dB)	(dB)	(dB)	(dB)	K	Delta	(MHz)	(dBm)	(dBm)	(dB)
20	25.20	27.93	25.55	16.10	1.04	0.74	20	37.28	20.30	2.22
30	25.23	28.14	27.11	16.72	1.05	0.72	30	37.08	20.47	2.25
50	25.19	28.25	25.97	16.68	1.05	0.71	50	36.97	20.47	2.21
100	25.11	28.21	25.61	16.33	1.05	0.71	100	37.07	20.48	2.36
150	25.03	27.97	25.04	15.82	1.04	0.72	200	37.04	20.44	2.20
200	24.95	28.06	23.79	15.24	1.05	0.71	300	36.79	20.07	2.46
250	24.84	27.98	22.39	14.44	1.04	0.70	400	36.58	20.30	2.32
300	24.73	27.97	21.39	13.75	1.04	0.70	500	36.29	19.82	2.39
350	24.62	28.02	20.82	13.24	1.05	0.69	600	36.00	20.00	2.28
400	24.52	27.85	20.14	12.69	1.04	0.69	700	35.58	19.76	2.44
450	24.41	27.88	19.61	12.17	1.04	0.68	800	35.14	19.44	2.30
500	24.29	27.82	18.97	11.61	1.03	0.68	900	34.62	19.50	2.34
600	24.02	27.68	17.86	10.81	1.03	0.67	1000	33.95	18.82	2.25
700	23.76	27.56	17.00	9.89	1.02	0.66	1100	33.42	18.96	2.32
800	23.48	27.58	16.05	9.13	1.02	0.65	1200	33.06	18.47	2.33
900	23.17	27.44	15.32	8.46	1.01	0.64	1300	32.58	18.22	2.35
1000	22.83	27.32	14.60	7.85	1.01	0.63	1400	32.17	17.94	2.39
1100	22.50	27.20	13.99	7.29	1.00	0.62	1500	31.86	17.11	2.46
1200	22.15	27.16	13.44	6.80	1.00	0.61	1600	31.83	17.06	2.44
1300	21.78	27.06	12.92	6.40	1.00	0.60	1700	31.50	16.08	2.34
1400	21.42	26.92	12.43	5.99	0.99	0.60	1800	31.04	16.11	2.46
1500	21.06	26.85	11.97	5.66	0.99	0.59	1900	30.46	15.75	2.40
1600	20.67	26.80	11.61	5.41	0.99	0.58	2000	29.81	14.72	2.44
1700	20.32	26.67	11.20	5.11	0.99	0.58	2100	29.18	15.02	2.29
1800	19.96	26.59	10.91	4.87	0.99	0.57	2200	28.75	13.99	2.47
2000	19.21	26.47	10.23	4.47	0.99	0.56	2300	28.71	14.02	2.29
2200	18.46	26.29	9.57	4.12	0.99	0.55	2400	28.79	13.81	2.42
2400	17.70	26.12	9.09	3.84	1.00	0.55	2500	28.65	13.14	2.35
2600	16.99	26.09	8.53	3.62	1.02	0.54	2600	28.18	13.30	2.55
2800	16.24	26.00	8.05	3.47	1.05	0.54	2700	27.56	12.22	2.38
3000	15.47	25.85	7.40	3.21	1.05	0.54	2800	26.91	12.66	2.57
3200	14.71	25.81	6.83	3.09	1.08	0.55	2900	26.77	12.41	2.46
3400	13.99	25.73	6.25	2.90	1.08	0.56	3000	26.83	11.44	2.49
3600	13.16	26.01	5.72	2.75	1.12	0.56	3100	26.92	11.90	2.47
4000	11.51	26.27	4.74	2.51	1.19	0.57	3200	26.72	10.72	2.50
4500	9.47	26.76	3.78	2.24	1.26	0.60	3300	26.34	11.27	2.54
5000	7.35	27.29	3.05	1.97	1.33	0.63	3400	25.86	10.68	2.89
5500	5.06	28.30	2.52	1.69	1.45	0.66	3600	25.45	10.60	2.88
6000	2.69	29.10	2.12	1.46	1.57	0.69	3800	25.40	10.11	3.03
7000	-1.99	31.00	1.64	1.18	2.10	0.74	4000	24.88	9.11	2.93

REV. X1

MERA-7456+

120125

Page 4 of 11



IF/RF MICROWAVE COMPONENTS • ISO 9001 ISO 14001 AS 9100 CERTIFIED • RoHS compliant

P.O. Box 350166, Brooklyn, New York 11235-0003 (718) 934-4500 Fax (718) 332-4661



The Design Engineers Search Engine finds the model you need, Instantly • For detailed performance specs & shopping online see





# MMIC Amplifier

# MERA-7456+

## Typical Performance Data

### Definitions:

Input Return Loss = -S11 (dB)

Gain(Power Gain) = S21 (dB)

Reverse Isolation = -S12 (dB)

Output Return Loss = -S22 (dB)

TEST CONDITIONS: Icc = 64mA, Vd=5.03V @Temperature = -45degC

FREQ	Gain	Isolation	Input Return Loss	Output Return Loss	Stability		FREQ	IP3 Output	1dB Comp. Output	Noise Figure
(MHz)	(dB)	(dB)	(dB)	(dB)	K	Delta	(MHz)	(dBm)	(dBm)	(dB)
20	24.98	27.59	30.16	17.85	1.04	0.74	20	34.12	19.15	2.20
30	25.02	28.26	32.30	18.41	1.06	0.69	30	33.93	18.95	2.20
50	24.97	27.85	30.89	18.29	1.05	0.72	50	33.81	19.08	2.16
100	24.90	27.92	29.29	17.80	1.05	0.71	100	33.90	19.00	2.29
150	24.83	27.93	27.95	17.17	1.05	0.70	150	33.99	19.13	2.18
200	24.75	27.72	26.01	16.35	1.04	0.71	200	33.97	18.82	2.40
250	24.64	27.80	24.38	15.42	1.05	0.70	250	34.00	18.89	2.27
300	24.53	27.80	23.03	14.66	1.05	0.69	300	33.93	18.60	2.32
350	24.43	27.66	22.22	14.07	1.04	0.69	350	33.88	18.60	2.27
400	24.34	27.55	21.50	13.39	1.03	0.69	400	33.66	18.49	2.38
450	24.22	27.37	20.79	12.85	1.03	0.70	450	33.50	18.25	2.26
500	24.10	27.43	20.07	12.25	1.03	0.69	500	33.33	18.44	2.29
600	23.85	27.45	18.81	11.33	1.03	0.67	600	32.96	18.08	2.22
700	23.60	27.34	17.76	10.34	1.02	0.66	700	32.66	18.19	2.26
800	23.32	27.18	16.69	9.50	1.01	0.66	800	32.39	17.94	2.29
900	23.02	27.08	15.91	8.79	1.00	0.65	900	31.96	17.71	2.29
1000	22.69	27.00	15.12	8.14	1.00	0.63	1000	31.52	17.56	2.34
1100	22.37	26.89	14.46	7.55	0.99	0.63	1100	31.23	16.69	2.40
1200	22.04	26.78	13.86	7.03	0.99	0.62	1200	31.27	16.64	2.37
1300	21.66	26.71	13.28	6.59	0.99	0.61	1300	30.98	15.68	2.26
1400	21.31	26.65	12.74	6.18	0.98	0.60	1400	30.53	15.69	2.40
1500	20.96	26.46	12.26	5.84	0.98	0.60	1500	29.95	15.35	2.33
1600	20.57	26.52	11.88	5.58	0.98	0.58	1600	29.30	14.29	2.38
1700	20.22	26.35	11.44	5.25	0.98	0.58	1700	28.67	14.60	2.22
1800	19.85	26.30	11.11	5.01	0.98	0.57	1800	28.26	13.59	2.40
2000	19.12	26.17	10.41	4.58	0.98	0.56	2000	28.21	13.58	2.24
2200	18.37	25.94	9.72	4.21	0.98	0.55	2200	28.29	13.41	2.33
2400	17.61	25.88	9.22	3.94	1.00	0.54	2400	28.14	12.71	2.28
2600	16.90	25.85	8.64	3.70	1.01	0.54	2600	27.66	12.88	2.48
2800	16.16	25.75	8.15	3.54	1.04	0.53	2800	27.03	11.88	2.33
3000	15.39	25.65	7.49	3.29	1.05	0.54	3000	26.40	12.23	2.52
3200	14.62	25.58	6.89	3.17	1.07	0.54	3200	26.27	12.02	2.39
3400	13.90	25.55	6.31	2.98	1.08	0.55	3400	26.33	11.02	2.41
3600	13.08	25.72	5.76	2.82	1.11	0.55	3600	26.39	11.50	2.37
4000	11.42	25.96	4.78	2.58	1.18	0.57	4000	26.18	10.35	2.41
4500	9.37	26.43	3.81	2.32	1.25	0.59	4500	25.84	10.88	2.47
5000	7.25	27.22	3.08	2.04	1.34	0.62	5000	25.31	10.31	2.82
5500	4.98	28.18	2.54	1.76	1.46	0.65	5500	24.98	10.22	2.76
6000	2.60	28.92	2.14	1.53	1.58	0.68	6000	24.89	9.74	2.92
7000	-2.07	30.94	1.65	1.24	2.15	0.73	7000	24.44	8.78	2.81

REV. X1

MERA-7456+

120125

Page 5 of 11



IF/RF MICROWAVE COMPONENTS • ISO 9001 ISO 14001 AS 9100 CERTIFIED • RoHS compliant

P.O. Box 350166, Brooklyn, New York 11235-0003 (718) 934-4500 Fax (718) 332-4661



The Design Engineers Search Engine finds the model you need, Instantly • For detailed performance specs & shopping online see



# MMIC Amplifier

# MERA-7456+

## Typical Performance Data

### Definitions:

Input Return Loss = -S11 (dB)

Gain(Power Gain) = S21 (dB)

Reverse Isolation = -S12 (dB)

Output Return Loss = -S22 (dB)

TEST CONDITIONS: Icc = 96mA, Vd=5.13V @Temperature = -45degC

FREQ	Gain	Isolation	Input Return Loss	Output Return Loss	Stability		FREQ	IP3 Output	1dB Comp. Output	Noise Figure
					K	Delta				
(MHz)	(dB)	(dB)	(dB)	(dB)	K	Delta	(MHz)	(dBm)	(dBm)	(dB)
20	25.33	28.80	24.11	15.47	1.07	0.68	20	39.61	20.58	2.27
30	25.36	27.94	24.16	15.88	1.03	0.75	30	39.40	20.83	2.27
50	25.32	28.32	23.70	15.74	1.05	0.72	50	39.28	20.82	2.25
100	25.24	28.35	23.68	15.45	1.05	0.71	100	39.38	20.92	2.40
150	25.16	28.15	23.11	15.09	1.04	0.72	200	39.04	20.99	2.23
200	25.07	28.36	22.29	14.50	1.05	0.69	300	38.48	20.66	2.55
250	24.96	28.19	21.32	13.84	1.05	0.70	400	38.02	21.09	2.34
300	24.85	28.33	20.30	13.19	1.05	0.68	500	37.52	20.23	2.45
350	24.74	28.11	19.85	12.73	1.04	0.69	600	37.03	20.77	2.33
400	24.63	28.01	19.36	12.24	1.04	0.69	700	36.48	20.22	2.49
450	24.53	27.98	18.83	11.74	1.03	0.69	800	35.89	19.81	2.34
500	24.40	27.97	18.23	11.27	1.03	0.68	900	35.23	19.79	2.39
600	24.13	27.82	17.23	10.49	1.03	0.67	1000	34.46	19.02	2.30
700	23.86	27.82	16.46	9.62	1.03	0.66	1100	33.87	19.23	2.37
800	23.57	27.67	15.59	8.90	1.02	0.65	1200	33.46	18.68	2.37
900	23.26	27.60	14.91	8.25	1.01	0.64	1300	33.00	18.46	2.40
1000	22.92	27.52	14.26	7.67	1.01	0.63	1400	32.59	18.19	2.43
1100	22.58	27.43	13.68	7.13	1.01	0.62	1500	32.31	17.39	2.53
1200	22.24	27.33	13.15	6.66	1.00	0.62	1600	32.26	17.37	2.49
1300	21.86	27.26	12.66	6.26	1.00	0.60	1700	31.91	16.39	2.39
1400	21.50	27.15	12.18	5.88	1.00	0.60	1800	31.46	16.45	2.51
1500	21.14	27.06	11.76	5.56	0.99	0.59	1900	30.88	16.09	2.45
1600	20.75	26.99	11.41	5.32	1.00	0.58	2000	30.23	15.07	2.50
1700	20.39	26.84	11.03	5.02	0.99	0.58	2100	29.60	15.40	2.33
1800	20.03	26.77	10.73	4.79	0.99	0.57	2200	29.19	14.36	2.51
2000	19.27	26.63	10.08	4.40	1.00	0.56	2300	29.15	14.41	2.38
2200	18.53	26.49	9.45	4.04	1.00	0.55	2400	29.24	14.19	2.46
2400	17.78	26.32	8.98	3.78	1.01	0.55	2500	29.13	13.50	2.45
2600	17.05	26.26	8.43	3.56	1.03	0.54	2600	28.64	13.68	2.63
2800	16.33	26.22	7.96	3.42	1.06	0.54	2700	28.03	12.59	2.46
3000	15.55	26.02	7.33	3.16	1.06	0.55	2800	27.37	13.02	2.67
3200	14.78	26.00	6.77	3.03	1.08	0.55	2900	27.25	12.76	2.56
3400	14.07	26.02	6.20	2.84	1.09	0.56	3000	27.29	11.81	2.57
3600	13.25	26.15	5.67	2.68	1.12	0.56	3100	27.38	12.27	2.54
4000	11.59	26.39	4.71	2.45	1.18	0.58	3200	27.19	11.12	2.59
4500	9.55	26.86	3.75	2.17	1.25	0.61	3300	26.78	11.63	2.63
5000	7.42	27.55	3.03	1.91	1.33	0.64	3400	26.30	11.05	2.99
5500	5.16	28.46	2.50	1.64	1.43	0.67	3600	25.90	10.98	2.98
6000	2.76	29.09	2.10	1.40	1.53	0.70	3800	25.84	10.48	3.10
7000	-1.92	31.17	1.64	1.14	2.08	0.74	4000	25.36	9.49	3.05

REV. X1

MERA-7456+

120125

Page 6 of 11



IF/RF MICROWAVE COMPONENTS • ISO 9001 ISO 14001 AS 9100 CERTIFIED • RoHS compliant

P.O. Box 350166, Brooklyn, New York 11235-0003 (718) 934-4500 Fax (718) 332-4661



The Design Engineers Search Engine finds the model you need, Instantly • For detailed performance specs & shopping online see



## Typical Performance Data

### Definitions:

Input Return Loss = -S11 (dB)

Gain(Power Gain) = S21 (dB)

Reverse Isolation = -S12 (dB)

Output Return Loss = -S22 (dB)

TEST CONDITIONS: Icc = 80mA, Vd=4.63V @Temperature = +85degC

FREQ	Gain	Isolation	Input Return Loss	Output Return Loss	Stability		FREQ	IP3 Output	1dB Comp. Output	Noise Figure
(MHz)	(dB)	(dB)	(dB)	(dB)	K	Delta	(MHz)	(dBm)	(dBm)	(dB)
20	24.93	27.72	28.43	17.37	1.04	0.73	20	36.25	19.27	2.89
30	24.96	27.61	29.15	17.69	1.04	0.74	30	35.96	19.45	2.90
50	24.91	27.92	27.33	17.59	1.05	0.71	50	35.79	19.46	2.89
100	24.82	27.85	26.13	17.00	1.05	0.71	100	35.81	19.51	3.09
150	24.73	27.95	24.95	16.23	1.06	0.70	200	35.56	19.48	2.96
200	24.64	27.90	23.69	15.53	1.05	0.69	300	35.06	19.04	3.26
250	24.52	28.02	22.59	14.86	1.06	0.67	400	34.65	19.42	3.10
300	24.40	27.93	21.71	14.19	1.06	0.67	500	34.14	18.73	3.19
350	24.28	27.84	21.41	13.73	1.05	0.67	600	33.66	19.10	3.10
400	24.18	27.73	20.89	13.16	1.05	0.67	700	33.15	18.66	3.26
450	24.06	27.70	20.34	12.63	1.05	0.66	800	32.59	18.18	3.13
500	23.93	27.62	19.64	12.05	1.04	0.66	900	31.98	18.22	3.19
600	23.65	27.54	18.45	11.19	1.04	0.65	1000	31.26	17.43	3.11
700	23.37	27.47	17.60	10.28	1.04	0.64	1100	30.67	17.58	3.14
800	23.07	27.34	16.63	9.52	1.03	0.63	1200	30.21	17.03	3.21
900	22.75	27.25	16.01	8.85	1.03	0.62	1300	29.67	16.77	3.19
1000	22.41	27.14	15.30	8.23	1.02	0.61	1400	29.16	16.58	3.28
1100	22.05	27.02	14.64	7.70	1.02	0.60	1500	28.83	15.57	3.34
1200	21.70	26.89	14.05	7.20	1.01	0.59	1600	28.81	15.62	3.34
1300	21.30	26.87	13.53	6.77	1.02	0.57	1700	28.53	14.59	3.21
1400	20.92	26.73	13.00	6.36	1.01	0.57	1800	28.02	14.67	3.37
1500	20.54	26.59	12.57	6.03	1.01	0.56	1900	27.37	14.36	3.27
1600	20.14	26.63	12.24	5.77	1.02	0.54	2000	26.72	13.09	3.37
1700	19.75	26.50	11.78	5.48	1.02	0.54	2100	26.10	13.67	3.19
1800	19.37	26.39	11.40	5.25	1.03	0.53	2200	25.73	12.55	3.40
2000	18.57	26.21	10.60	4.83	1.03	0.52	2300	25.67	12.56	3.23
2200	17.78	26.11	9.94	4.47	1.05	0.51	2400	25.73	12.44	3.36
2400	16.99	25.98	9.42	4.25	1.07	0.50	2500	25.50	11.52	3.30
2600	16.20	25.92	8.76	4.04	1.10	0.50	2600	24.97	11.94	3.52
2800	15.42	25.81	8.25	3.90	1.14	0.49	2700	24.38	10.68	3.37
3000	14.64	25.71	7.62	3.70	1.16	0.50	2800	23.79	11.22	3.56
3200	13.84	25.66	7.05	3.57	1.19	0.50	2900	23.72	11.11	3.47
3400	13.09	25.67	6.49	3.41	1.22	0.50	3000	23.83	9.69	3.44
3600	12.28	25.81	5.94	3.28	1.26	0.51	3100	23.87	10.57	3.50
4000	10.55	26.13	4.92	3.02	1.37	0.52	3200	23.59	9.21	3.49
4500	8.35	26.66	3.89	2.70	1.48	0.55	3300	23.18	9.92	3.59
5000	6.11	27.41	3.17	2.47	1.66	0.58	3400	22.78	9.44	3.85
5500	3.74	28.35	2.68	2.24	1.92	0.60	3600	22.53	9.38	3.89
6000	1.43	29.19	2.39	2.04	2.26	0.62	3800	22.40	8.87	3.96
7000	-2.97	30.94	2.08	1.73	3.43	0.66	4000	21.97	7.57	4.06

REV. X1

MERA-7456+

120125

Page 7 of 11



IF/RF MICROWAVE COMPONENTS • ISO 9001 ISO 14001 AS 9100 CERTIFIED • RoHS compliant

P.O. Box 350166, Brooklyn, New York 11235-0003 (718) 934-4500 Fax (718) 332-4661



The Design Engineers Search Engine finds the model you need, Instantly • For detailed performance specs & shopping online see



## Typical Performance Data

### Definitions:

Input Return Loss = -S11 (dB)

Gain(Power Gain) = S21 (dB)

Reverse Isolation = -S12 (dB)

Output Return Loss = -S22 (dB)

TEST CONDITIONS: Icc = 64mA, Vd=4.58V @Temperature = +85degC

FREQ	Gain	Isolation	Input Return Loss	Output Return Loss	Stability		FREQ	IP3 Output	1dB Comp. Output	Noise Figure
					K	Delta				
(MHz)	(dB)	(dB)	(dB)	(dB)	K	Delta	(MHz)	(dBm)	(dBm)	(dB)
20	24.65	27.83	36.34	19.51	1.06	0.70	20	33.33	18.59	2.86
30	24.68	27.29	38.66	20.13	1.04	0.74	30	33.11	18.45	2.86
50	24.64	27.64	35.27	19.91	1.05	0.71	50	32.94	18.46	2.84
100	24.55	27.68	31.44	18.99	1.06	0.70	100	33.01	18.44	3.01
150	24.47	27.86	28.66	18.08	1.07	0.68	200	33.00	18.54	2.92
200	24.38	27.49	26.81	17.09	1.05	0.70	300	32.76	18.14	3.18
250	24.26	27.52	25.02	16.13	1.05	0.69	400	32.58	18.32	3.04
300	24.15	27.50	23.84	15.35	1.05	0.68	500	32.31	17.97	3.12
350	24.05	27.52	23.21	14.75	1.05	0.67	600	32.07	18.04	3.06
400	23.95	27.43	22.49	14.10	1.05	0.67	700	31.72	17.91	3.18
450	23.84	27.40	21.77	13.49	1.05	0.66	800	31.39	17.47	3.09
500	23.71	27.21	20.93	12.83	1.04	0.67	900	31.02	17.64	3.11
600	23.44	27.23	19.53	11.85	1.04	0.65	1000	30.46	17.02	3.08
700	23.16	27.11	18.49	10.83	1.03	0.64	1100	30.02	17.08	3.08
800	22.89	26.95	17.37	9.98	1.02	0.63	1200	29.62	16.67	3.16
900	22.58	26.89	16.68	9.26	1.02	0.62	1300	29.08	16.34	3.13
1000	22.24	26.75	15.85	8.59	1.01	0.61	1400	28.57	16.21	3.23
1100	21.90	26.64	15.12	8.01	1.01	0.60	1500	28.25	15.16	3.24
1200	21.56	26.55	14.51	7.47	1.01	0.59	1600	28.25	15.17	3.26
1300	21.16	26.40	13.91	7.02	1.00	0.58	1700	28.00	14.18	3.13
1400	20.79	26.37	13.33	6.58	1.00	0.57	1800	27.49	14.21	3.30
1500	20.41	26.30	12.88	6.22	1.00	0.56	1900	26.84	13.93	3.20
1600	20.02	26.20	12.51	5.95	1.01	0.55	2000	26.19	12.61	3.29
1700	19.65	26.05	12.03	5.64	1.00	0.54	2100	25.58	13.21	3.09
1800	19.27	25.94	11.61	5.40	1.00	0.54	2200	25.20	12.10	3.31
2000	18.48	25.89	10.80	4.95	1.02	0.52	2300	25.14	12.05	3.12
2200	17.68	25.81	10.08	4.59	1.03	0.51	2400	25.20	11.99	3.27
2400	16.88	25.62	9.55	4.35	1.06	0.50	2500	24.95	11.06	3.20
2600	16.11	25.55	8.87	4.14	1.08	0.50	2600	24.43	11.47	3.42
2800	15.33	25.48	8.33	3.99	1.12	0.49	2700	23.83	10.23	3.24
3000	14.54	25.40	7.69	3.79	1.14	0.49	2800	23.25	10.76	3.45
3200	13.74	25.35	7.10	3.66	1.18	0.49	2900	23.19	10.68	3.36
3400	13.00	25.33	6.53	3.50	1.20	0.50	3000	23.30	9.22	3.34
3600	12.18	25.55	5.97	3.37	1.26	0.50	3100	23.36	10.11	3.40
4000	10.45	25.80	4.95	3.11	1.35	0.52	3200	23.07	8.80	3.37
4500	8.25	26.46	3.91	2.79	1.48	0.54	3300	22.68	9.48	3.51
5000	6.01	27.20	3.19	2.56	1.66	0.57	3400	22.26	9.01	3.75
5500	3.66	28.18	2.69	2.31	1.93	0.59	3600	22.01	8.95	3.74
6000	1.35	29.10	2.41	2.10	2.29	0.62	3800	21.88	8.44	3.86
7000	-3.04	30.92	2.09	1.79	3.51	0.65	4000	21.45	7.14	3.89

REV. X1

MERA-7456+

120125

Page 8 of 11



IF/RF MICROWAVE COMPONENTS • ISO 9001 ISO 14001 AS 9100 CERTIFIED • RoHS compliant

P.O. Box 350166, Brooklyn, New York 11235-0003 (718) 934-4500 Fax (718) 332-4661



The Design Engineers Search Engine finds the model you need, Instantly • For detailed performance specs & shopping online see



# MMIC Amplifier

# MERA-7456+

## Typical Performance Data

### Definitions:

Input Return Loss = -S11 (dB)

Gain(Power Gain) = S21 (dB)

Reverse Isolation = -S12 (dB)

Output Return Loss = -S22 (dB)

TEST CONDITIONS: Icc = 96mA, Vd=4.68V @Temperature = +85degC

FREQ	Gain	Isolation	Input Return Loss	Output Return Loss	Stability		FREQ	IP3 Output	1dB Comp. Output	Noise Figure
(MHz)	(dB)	(dB)	(dB)	(dB)	K	Delta	(MHz)	(dBm)	(dBm)	(dB)
20	25.08	28.64	24.58	16.20	1.07	0.67	20	38.33	19.40	2.96
30	25.12	28.23	25.58	16.54	1.05	0.71	30	38.01	19.65	2.96
50	25.07	28.16	24.57	16.45	1.05	0.71	50	37.76	19.74	2.97
100	24.98	28.11	23.69	15.90	1.05	0.71	100	37.67	19.72	3.17
150	24.88	27.93	22.88	15.37	1.05	0.71	200	37.07	19.72	3.01
200	24.79	28.08	21.87	14.71	1.05	0.70	300	36.31	19.47	3.33
250	24.65	28.29	21.22	14.08	1.06	0.67	400	35.68	19.95	3.14
300	24.54	28.04	20.55	13.54	1.05	0.68	500	35.04	19.00	3.30
350	24.43	27.96	20.27	13.16	1.05	0.68	600	34.42	19.57	3.14
400	24.31	27.96	19.84	12.62	1.05	0.67	700	33.79	18.92	3.37
450	24.20	27.90	19.38	12.15	1.05	0.67	800	33.15	18.46	3.18
500	24.07	27.92	18.79	11.65	1.05	0.65	900	32.46	18.46	3.29
600	23.77	27.80	17.76	10.83	1.05	0.64	1000	31.69	17.60	3.18
700	23.49	27.70	16.98	9.96	1.04	0.63	1100	31.05	17.85	3.22
800	23.18	27.65	16.14	9.24	1.04	0.62	1200	30.59	17.24	3.26
900	22.85	27.45	15.56	8.61	1.03	0.62	1300	30.06	17.03	3.29
1000	22.50	27.31	14.89	8.04	1.03	0.61	1400	29.57	16.85	3.37
1100	22.14	27.19	14.27	7.51	1.02	0.60	1500	29.25	15.86	3.40
1200	21.79	27.22	13.74	7.03	1.03	0.58	1600	29.21	15.94	3.42
1300	21.38	27.07	13.24	6.63	1.03	0.57	1700	28.93	14.90	3.30
1400	21.01	26.98	12.74	6.23	1.02	0.57	1800	28.43	15.04	3.45
1500	20.62	26.89	12.35	5.91	1.02	0.56	1900	27.80	14.73	3.34
1600	20.22	26.87	12.03	5.67	1.03	0.54	2000	27.16	13.47	3.46
1700	19.84	26.74	11.59	5.38	1.03	0.54	2100	26.55	14.06	3.26
1800	19.45	26.64	11.22	5.16	1.04	0.53	2200	26.17	12.93	3.48
2000	18.64	26.50	10.48	4.76	1.05	0.52	2300	26.13	12.98	3.31
2200	17.84	26.39	9.80	4.42	1.06	0.51	2400	26.17	12.85	3.45
2400	17.05	26.17	9.32	4.19	1.08	0.51	2500	25.95	11.95	3.40
2600	16.27	26.06	8.68	3.99	1.11	0.50	2600	25.44	12.34	3.62
2800	15.49	26.10	8.17	3.84	1.15	0.49	2700	24.85	11.09	3.47
3000	14.71	25.93	7.55	3.64	1.17	0.50	2800	24.25	11.66	3.67
3200	13.91	25.88	6.99	3.52	1.20	0.50	2900	24.18	11.51	3.59
3400	13.17	25.89	6.43	3.35	1.23	0.51	3000	24.27	10.14	3.55
3600	12.36	25.97	5.89	3.23	1.27	0.51	3100	24.31	10.97	3.63
4000	10.63	26.21	4.89	2.97	1.36	0.53	3200	24.02	9.63	3.63
4500	8.43	26.85	3.87	2.64	1.49	0.56	3300	23.65	10.33	3.74
5000	6.17	27.57	3.16	2.42	1.66	0.58	3400	23.21	9.81	4.00
5500	3.81	28.54	2.66	2.19	1.92	0.61	3600	22.99	9.77	4.03
6000	1.50	29.40	2.37	1.99	2.26	0.63	3800	22.86	9.28	4.09
7000	-2.90	31.06	2.06	1.69	3.40	0.66	4000	22.40	7.96	4.22

REV. X1

MERA-7456+

120125

Page 9 of 11



IF/RF MICROWAVE COMPONENTS • ISO 9001 ISO 14001 AS 9100 CERTIFIED • RoHS compliant

P.O. Box 350166, Brooklyn, New York 11235-0003 (718) 934-4500 Fax (718) 332-4661



The Design Engineers Search Engine finds the model you need, Instantly • For detailed performance specs & shopping online see



## Typical Performance Curves

**GAIN vs. TEMPERATURE**

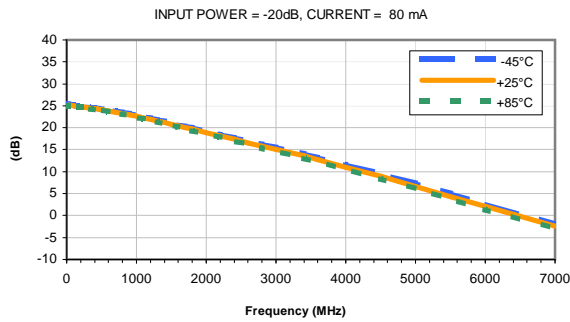

**GAIN vs. CURRENT**

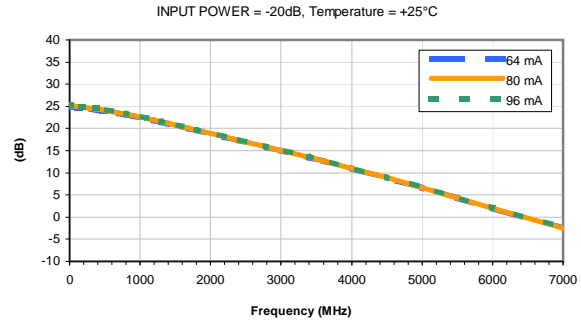

**ISOLATION vs. TEMPERATURE**

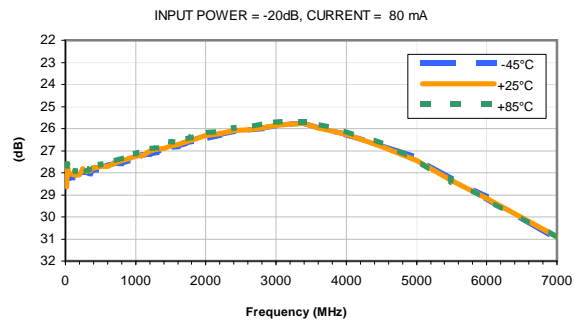

**ISOLATION vs. CURRENT**

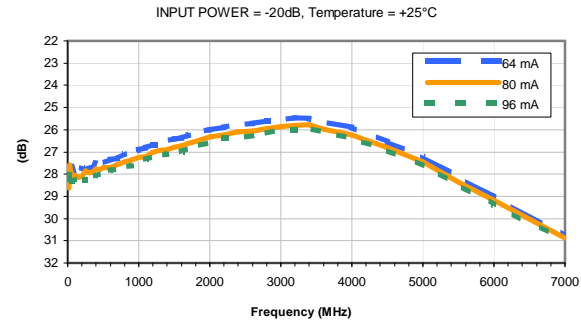

**INPUT RETURN LOSS vs. TEMPERATURE**

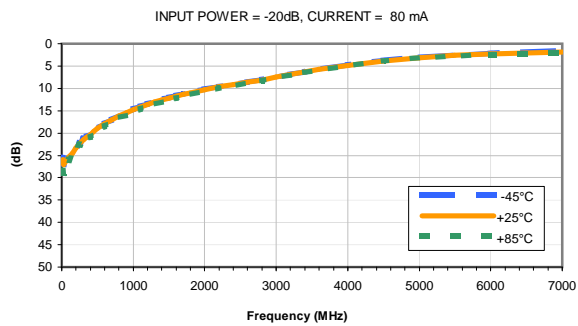

**INPUT RETURN LOSS vs. CURRENT**

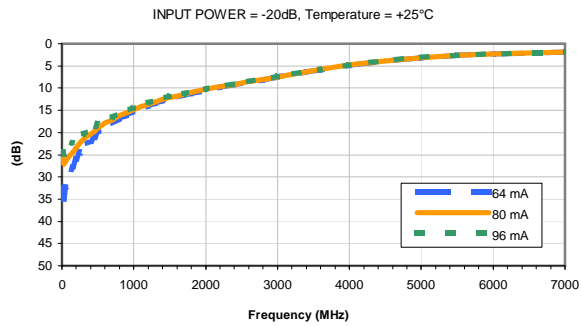

**OUTPUT RETURN LOSS vs. TEMPERATURE**

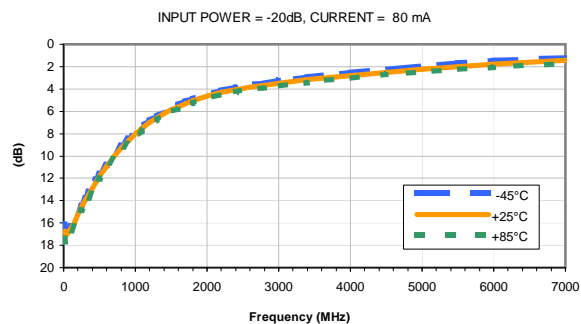

**OUTPUT RETURN LOSS vs. CURRENT**

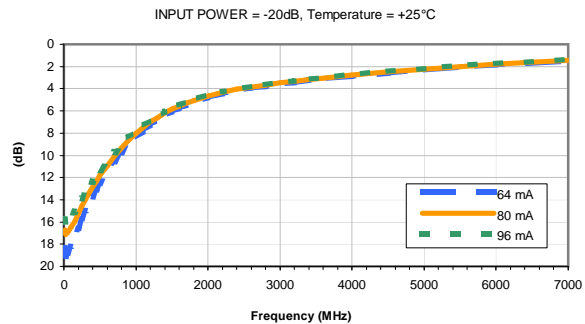

## Typical Performance Curves

**OUTPUT IP3 vs. TEMPERATURE**

INPUT POWER = -20dB, CURRENT = 80 mA

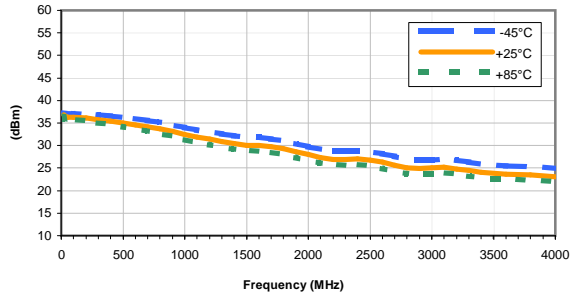

**OUTPUT IP-3 vs. CURRENT**

INPUT POWER = -20dB, Temperature = +25°C

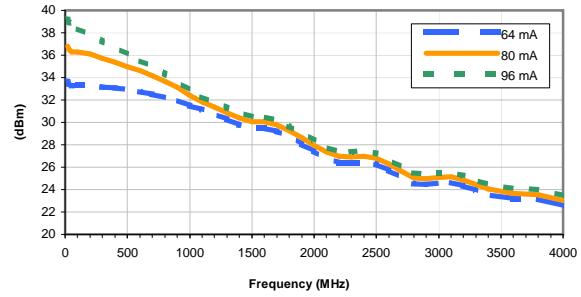

**OUTPUT POWER at 1dB Compression vs. TEMPERATURE**

CURRENT = 80 mA

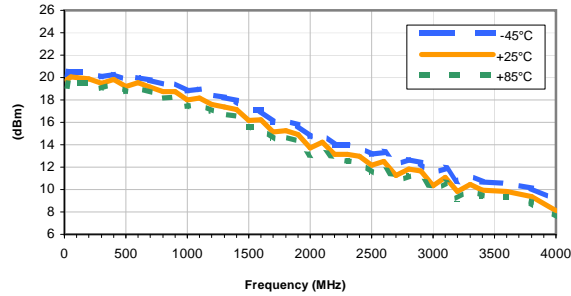

**OUTPUT POWER at 1dB Compression vs. CURRENT**

Temperature = +25°C

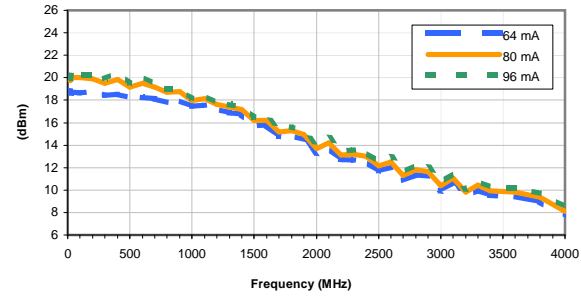

**Noise Figure vs. TEMPERATURE**

CURRENT = 80 mA

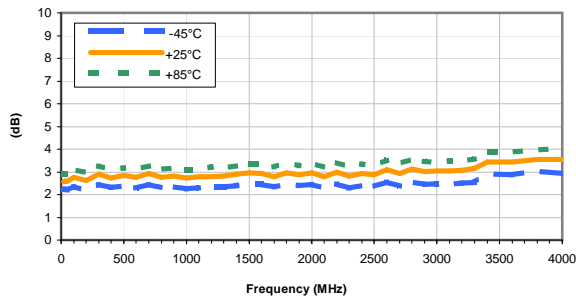

**Noise Figure vs. CURRENT**

Temperature = +25°C

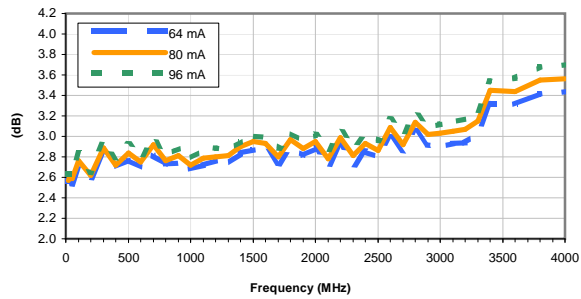

IF/RF MICROWAVE COMPONENTS • ISO 9001 ISO 14001 AS 9100 CERTIFIED RoHS compliant  
 P.O. Box 350166, Brooklyn, New York 11235-0003 (718) 934-4500 Fax (718) 332-4661



The Design Engineers Search Engine finds the model you need, Instantly • For detailed performance specs & shopping online see





## Typical Performance Curves

**GAIN vs. TEMPERATURE**

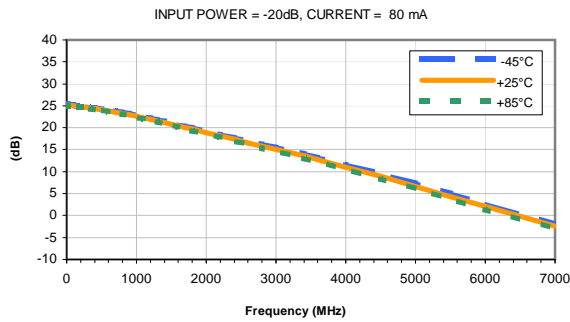

**GAIN vs. CURRENT**

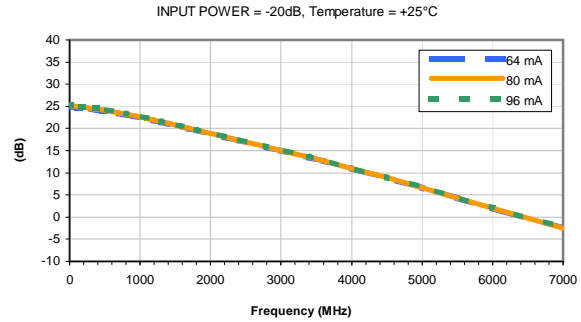

**ISOLATION vs. TEMPERATURE**

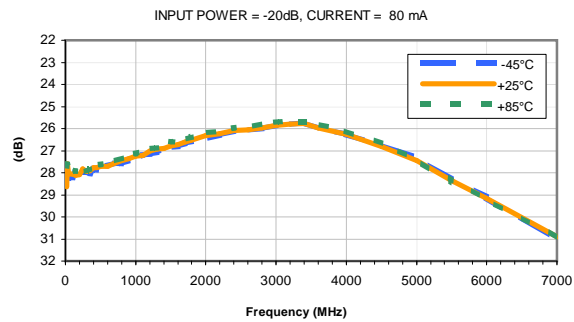

**ISOLATION vs. CURRENT**

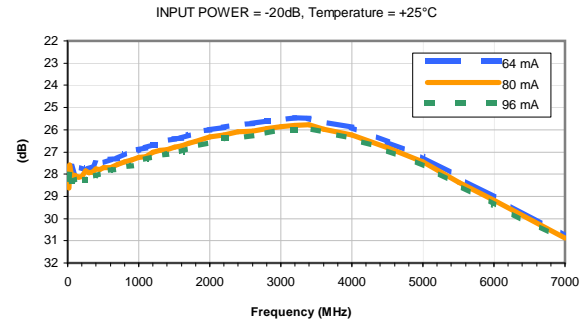

**INPUT RETURN LOSS vs. TEMPERATURE**

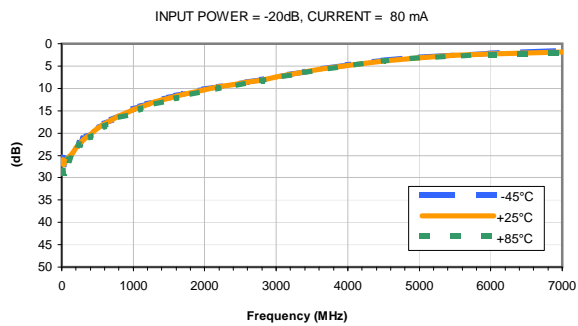

**INPUT RETURN LOSS vs. CURRENT**

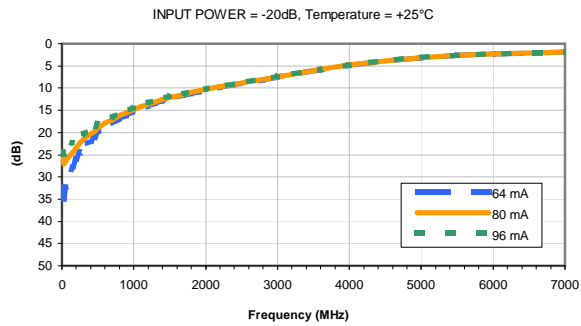

**OUTPUT RETURN LOSS vs. TEMPERATURE**

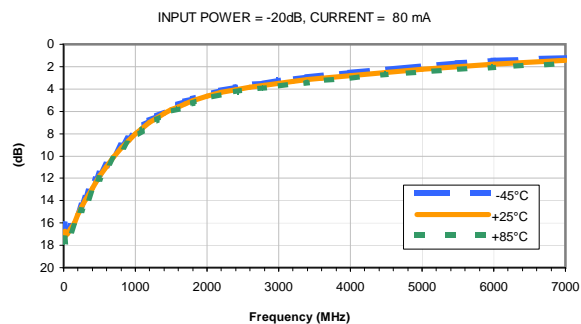

**OUTPUT RETURN LOSS vs. CURRENT**

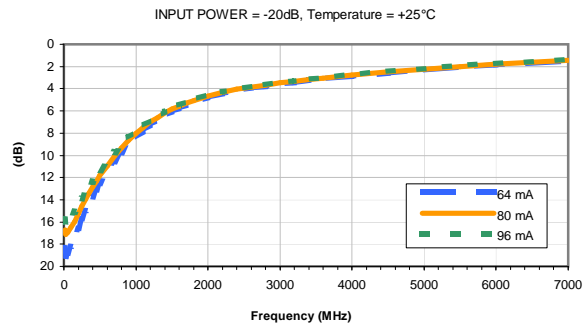

## Typical Performance Curves

**OUTPUT IP3 vs. TEMPERATURE**

INPUT POWER = -20dB, CURRENT = 80 mA

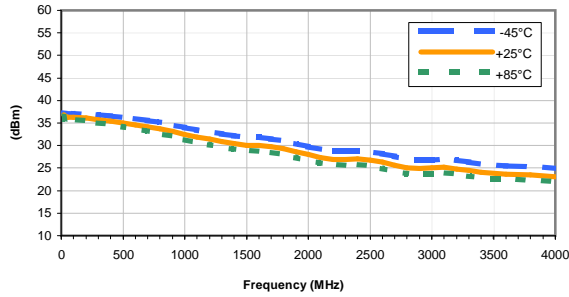

**OUTPUT IP-3 vs. CURRENT**

INPUT POWER = -20dB, Temperature = +25°C

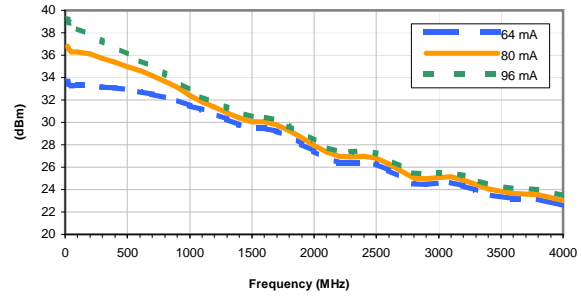

**OUTPUT POWER at 1dB Compression vs. TEMPERATURE**

CURRENT = 80 mA

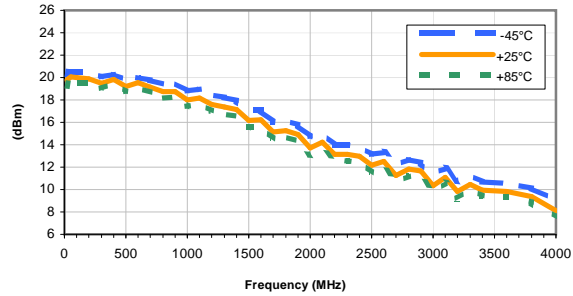

**OUTPUT POWER at 1dB Compression vs. CURRENT**

Temperature = +25°C

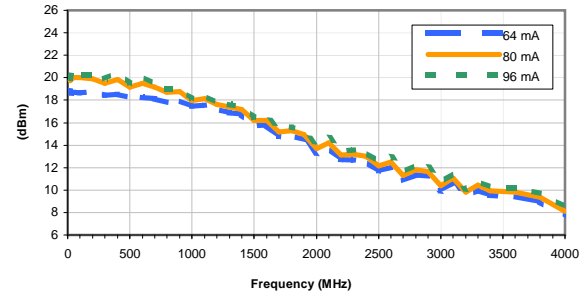

**Noise Figure vs. TEMPERATURE**

CURRENT = 80 mA

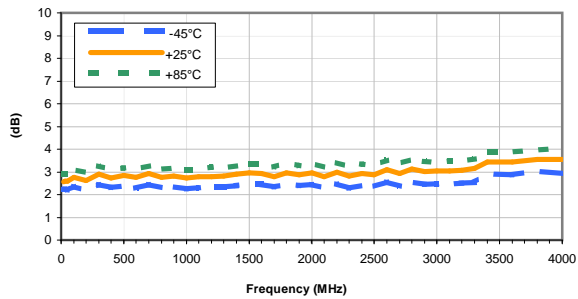

**Noise Figure vs. CURRENT**

Temperature = +25°C

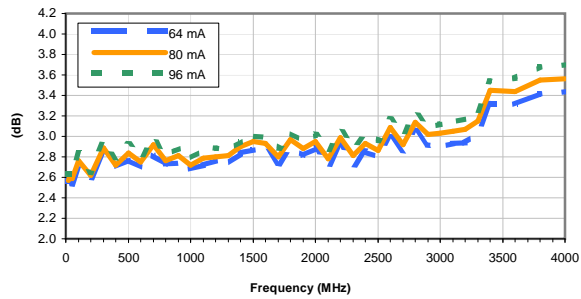

### Outline Dimensions

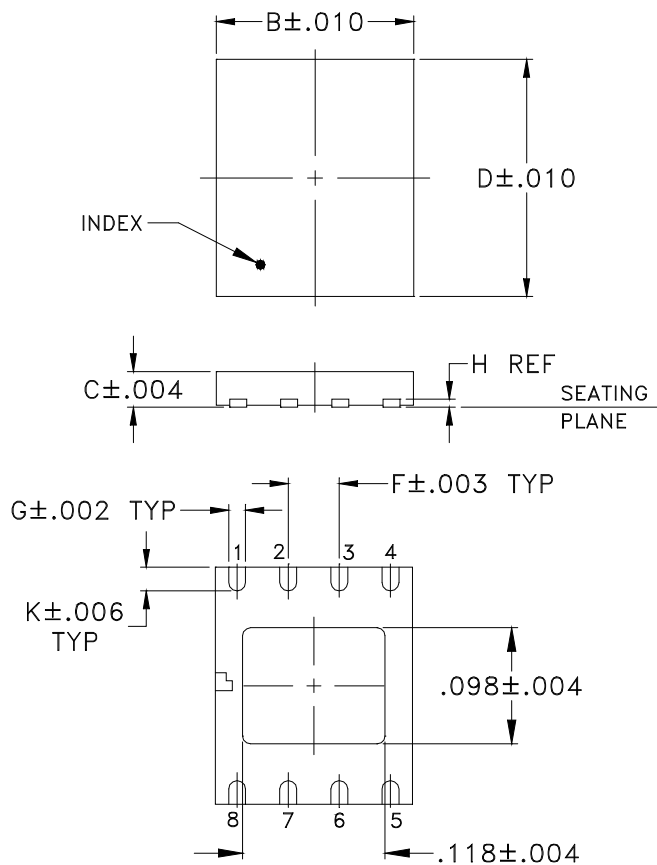

### PCB Land Pattern

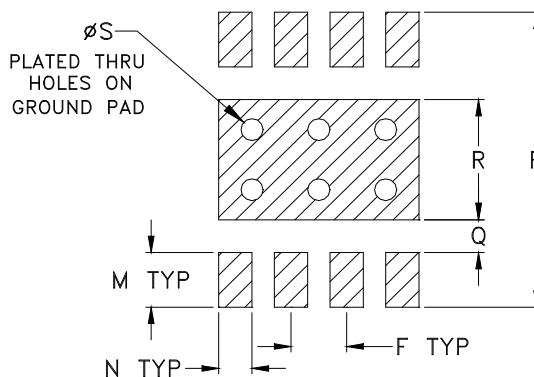

Suggested Layout,  
Tolerance to be within  $\pm .002$

CASE #	A	B	C	D	E	F	G	H	J	K	L	M	N
DL1020	--	.193 (4.90)	.035 (0.90)	.236 (6.00)	--	.050 (1.27)	.017 (0.42)	.008 (0.20)	--	.024 (0.60)	--	.050 (1.27)	.030 (0.76)

CASE #	P	Q	R	S	T	WT. GRAM
DL1020	.270 (6.86)	.030 (0.76)	.110 (2.79)	.020 (0.51)	--	.08

Dimensions are in inches (mm). Tolerances: 2 Pl.  $\pm .01$ ; 3Pl.  $\pm .004$

#### Notes:

- Case material: Plastic.
- Termination finish:  
For RoHS Case Styles: Tin-Silver alloy plate over Nickel barrier. All models, (+) suffix.  
For RoHS-5 Case Styles: Tin-Lead plate. All models, no (+) suffix.



P.O. Box 350166, Brooklyn, New York 11235-0003 (718) 934-4500 Fax (718) 332-4661 For detailed performance specs & shopping online see Mini-Circuits web site



The Design Engineers Search Engine Provides ACTUAL Data Instantly From MINI-CIRCUITS At: [www.minicircuits.com](http://www.minicircuits.com)

RF/IF MICROWAVE COMPONENTS

# Tape & Reel Packaging TR-F68

## DEVICE ORIENTATION IN T&R

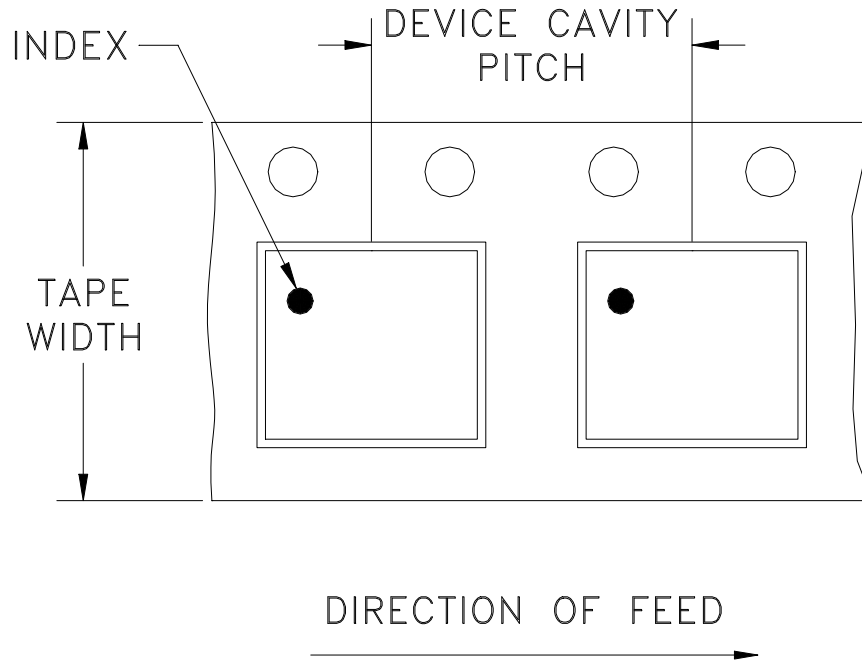

Tape Width, mm	Device Cavity Pitch, mm	Reel Size, inches	Devices per Reel see note	
12	8	7	Small quantity standard	20
				50
				100
				200
				500
		7	Standard	1000
		13	Standard	2000
				3000
4000				

Mini-Circuits carrier tape materials provide protection from ESD (Electro-Static Discharge) during handling and transportation. Tapes are static dissipative and comply with industry standards EIA-481/EIA-541.

Go to: [www.minicircuits.com/pages/pdfs/tape.pdf](http://www.minicircuits.com/pages/pdfs/tape.pdf)



INTERNET <http://www.minicircuits.com>

P.O. Box 350166, Brooklyn, New York 11235-0003 (718) 934-4500 Fax (718) 332-4661

Distribution Centers NORTH AMERICA 800-654-7949 • 417-335-5935 • Fax 417-335-5945 • EUROPE 44-1252-832600 • Fax 44-1252-837010

Mini-Circuits ISO 9001 & ISO 14001 Certified

THIRD ANGLE PROJECTION

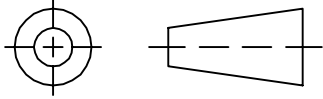

REVISIONS

REV	ECN No.	DESCRIPTION	DATE	DR	AUTH
OR	M93927	NEW RELEASE	08/19/04	GF	WP
A	M102713	ADDED "...WITH SMOBC"	01/12/06	GF	IL

SUGGESTED MOUNTING CONFIGURATION FOR DL1020 CASE STYLE, "qb" PIN CONNECTION

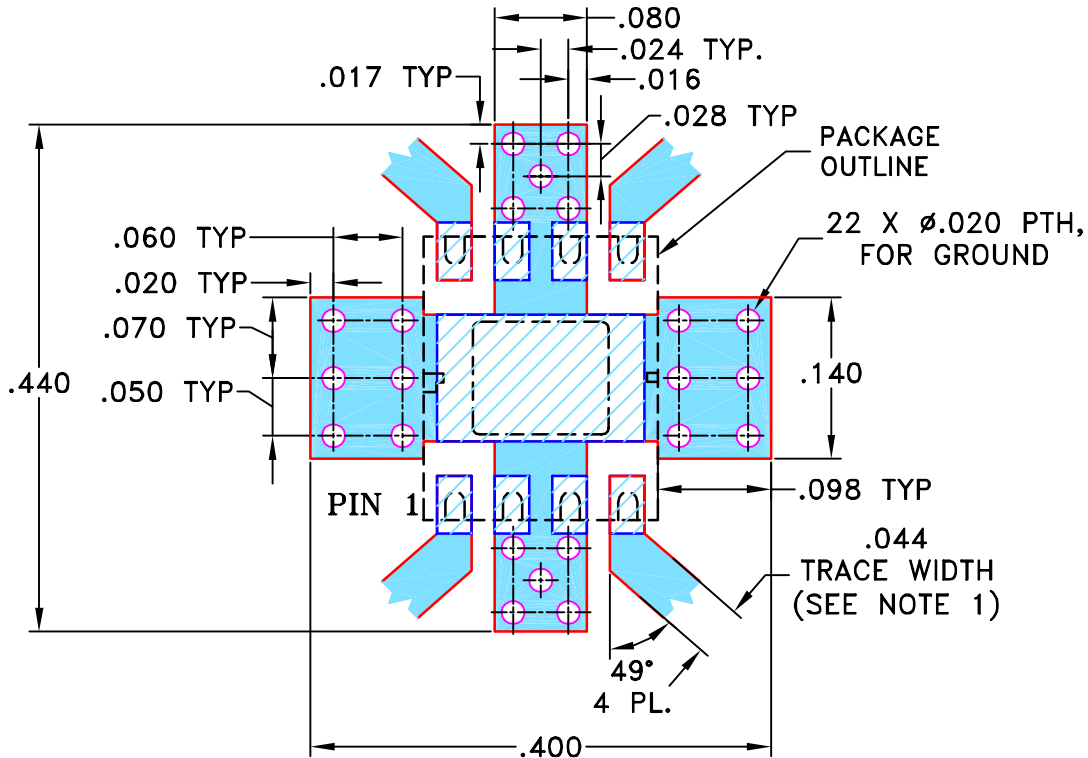

NOTES:

1. TRACE WIDTH IS SHOWN FOR ROGERS R04350B WITH DIELECTRIC THICKNESS .020" ± .0015". COPPER: 1/2 OZ. EACH SIDE. FOR OTHER MATERIALS TRACE WIDTH MAY NEED TO BE MODIFIED.
2. BOTTOM SIDE OF THE PCB IS CONTINUOUS GROUND PLANE.



DENOTES PCB COPPER LAYOUT WITH SMOBC (SOLDER MASK OVER BARE COPPER)



DENOTES COPPER LAND PATTERN FREE OF SOLDER MASK

UNLESS OTHERWISE SPECIFIED	INITIALS	DATE
DIMENSIONS ARE IN INCHES TOLERANCES ON: 2 PL DECIMALS ± 3 PL DECIMALS ± .005 ANGLES ± FRACTIONS ±	DRAWN	GF 08/18/04
	CHECKED	IL 08/19/04
	APPROVED	WP 08/19/04



**Mini-Circuits®** 13 Neptune Avenue  
Brooklyn NY 11235

PL, qb, DL1020, MERA556/7456, TB-293

Mini-Circuits®  
THIS DOCUMENT AND ITS CONTENTS ARE THE PROPERTY OF MINI-CIRCUITS. EXCEPT FOR USE EXPRESSLY GRANTED, IN WRITING, TO ITS VENDORS, VENDEE AND THE UNITED STATES GOVERNMENT, MINI-CIRCUITS RESERVES ALL PROPRIETARY DESIGN, USE, MANUFACTURING AND REPRODUCTION RIGHTS THERETO. THESE CONTENTS SHALL NOT BE USED, DUPLICATED OR DISCLOSED TO ANY OUTSIDE PARTY, IN WHOLE OR IN PART, WITHOUT WRITTEN PERMISSION OF MINI-CIRCUITS.

SIZE A	CODE IDENT 15542	DRAWING NO: 98-PL-164	REV: A
FILE: 98PL164	SCALE: 6:1	SHEET: 1 OF 1	

# Evaluation Board and Circuit

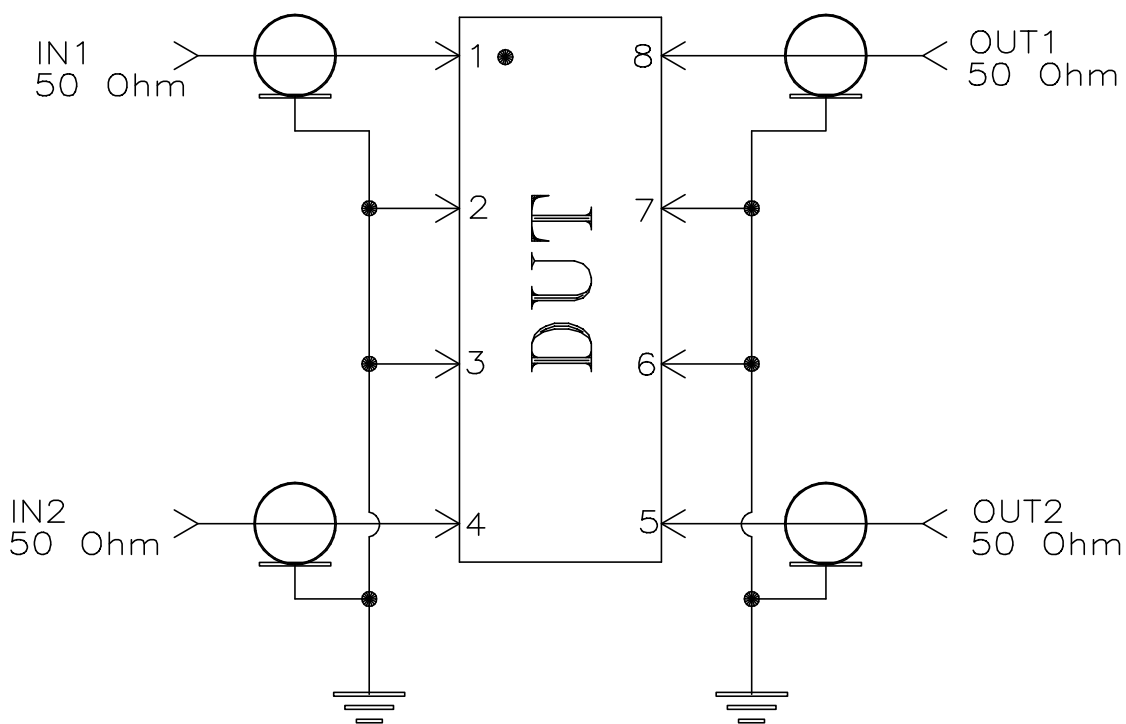
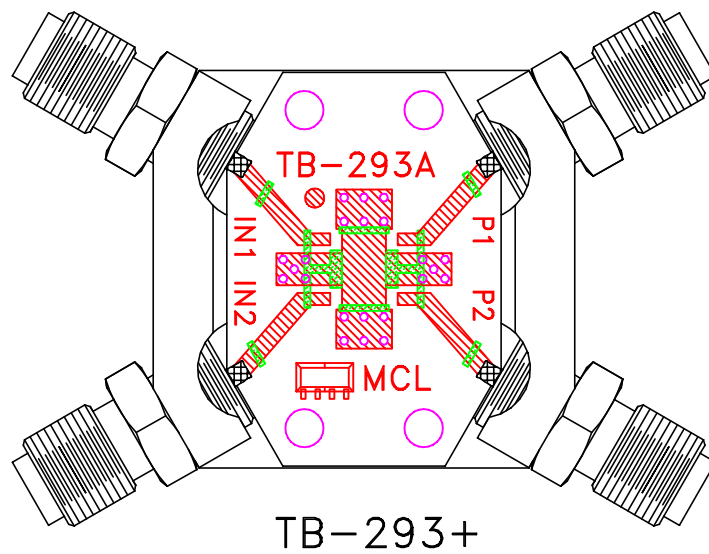

Schematic Diagram

## Notes:

1. SMA Female connectors.
2. PCB Material: Rogers R04350 or equivalent, Dielectric Constant=3.5, Thickness=.020 inch.

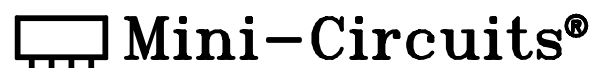

All Mini-Circuits products are manufactured under exacting quality assurance and control standards, and are capable of meeting published specifications after being subjected to any or all of the following physical and environmental test.

Specification	Test/Inspection Condition	Reference/Spec
Operating Temperature	-45° to 85°C Ambient Environment	Individual Model Data Sheet
Storage Temperature	-65° to 150° C Ambient Environment	Individual Model Data Sheet
Thermal Shock	-55° to 100°C, 100 cycles	MIL-STD-202, Method 107, Condition A-3, except +100°C
Mechanical Shock	1.5Kg, 0.5 ms, 5 shock pulses, Y1 direction only	MIL-STD-883, Method 2002, Condition B, except Y1 direction only
Vibration (Variable Frequency)	50g peak	MIL-STD-883, Method 2007, Condition B
Autoclave	15 psig, 100% RH, 121°C, 96 hours	JESD22-A102-C, Condition C
Solderability	10X Magnification	J-STD-002, Para 4.2.5, Test S, 95% Coverage
Solder Reflow Heat	Sn-Pb Eutetic Process: 240°C peak Pb-Free Process: 260°C peak	J-STD-020, Table 4-1, 4-2 and 5-2; Figure 5-1
Moisture Sensitivity: Level 1	Bake at 125°C for 24 hours. Soak at 85°C/85%RH for 168 hours Reflow 3 cycles at 260°C peak	J-STD-020