



SURFACE MOUNT

# Monolithic Amplifier

## MAR-8ASM+

50Ω DC to 1 GHz

### FEATURES

- Exact footprint substitute for MAR-8SM and MSA-0886<sup>a,b</sup>
- Benefits:
  - Lower device voltage, 3.7 typ.
  - Lower power dissipation in the MMIC
  - May eliminate need for choke (RFC)
- High gain, 31.5 dB at 0.1GHz, reduces component count
- High power output, +12.5 dBm typ.
- Internally Matched to 50 Ohms
- Low noise
- Improved stability
- Protection against power supply transients
- Protected by US Patent, 6,943,629



Generic photo used for illustration purposes only

CASE STYLE: WW107

**+RoHS Compliant**

The +Suffix identifies RoHS Compliance. See our website for methodologies and qualifications

### APPLICATIONS

- Cellular
- PCN instrumentation

### PRODUCT OVERVIEW

MAR-8ASM+ (RoHS compliant) is a wideband amplifier offering high dynamic range. It has repeatable performance from lot to lot. It is enclosed in a Micro-X package. MAR-8ASM+ uses Darlington configuration and is fabricated using InGaP HBT technology.

### SIMPLIFIED SCHEMATIC AND PIN DESCRIPTION

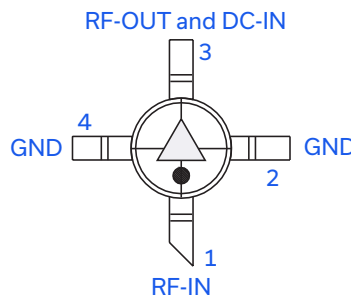
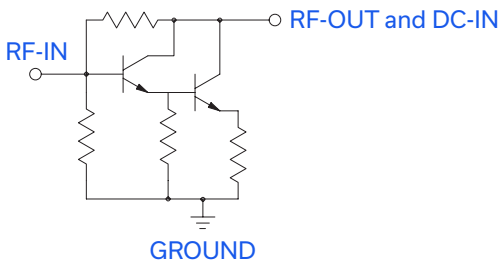

Function	Pin Number	Description
RF-IN	1	RF input pin. This pin requires the use of an external DC blocking capacitor chosen for the frequency of operation.
RF-OUT and DC-IN	3	RF output and bias pin. DC voltage is present on this pin; therefore a DC blocking capacitor is necessary for proper operation. An RF choke is needed to feed DC bias without loss of RF signal due to the bias connection, as shown in "Recommended Application Circuit".
GND	2,4	Connections to ground. Use via holes as shown in "Suggested Layout for PCB Design" to reduce ground path inductance for best performance.

a. Suitability for model replacement within a particular system must be determined by and is solely the responsibility of the customer based on, among other things, electrical performance criteria, stimulus conditions, application, compatibility with other components and environmental conditions and stresses.  
 b. The Avago MSA-0885 part number is used for identification and comparison purposes only.

REV. H  
 ECO-021753  
 MAR-8ASM+  
 MCL NY  
 240509





SURFACE MOUNT

# Monolithic Amplifier

## MAR-8ASM+

50Ω DC to 1 GHz

### ELECTRICAL SPECIFICATIONS AT 25°C AND 36 mA, UNLESS NOTED OTHERWISE

Parameter	Frequency (GHz)	Min.	Typ.	Max.	Units
Frequency Range <sup>1</sup>		DC		1	GHz
Gain	f=0.1	—	31.5	—	dB
	f=1	20 <sup>2</sup>	25	—	
Input Return Loss	f=DC to 1		15.5		dB
Output Return Loss	f=DC to 1		11		dB
Output Power @ 1 dB compression	f=1		+12.5		dBm
Output IP3	f=1		+25		dBm
Noise Figure	f=1		3.1		dB
Recommended Device Operating Current			36		mA
Device Operating Voltage			3.7		V
Device Voltage Variation vs. Temperature at 36 mA			+1.2		mV/°C
Device Voltage Variation vs. Current at 25°C			11.3		mV/mA
Thermal Resistance, junction-to-case <sup>2</sup>			140		°C/W

- 1. Guaranteed specification DC-1 GHz. Low frequency cut off determined by external coupling capacitors.
- 2. Full temperature range.

### ABSOLUTE MAXIMUM RATINGS<sup>3</sup>

Parameter	Ratings
Operating Temperature <sup>4</sup>	-40°C to 85°C
Storage Temperature	-55°C to 100°C
Operating Current	65 mA
Power Dissipation	250 mW
Input Power	+13 dBm

- 3. Permanent damage may occur if any of these limits are exceeded. These ratings are not intended for continuous normal operation.
- 4. Case is defined as ground leads.

### PRODUCT MARKING

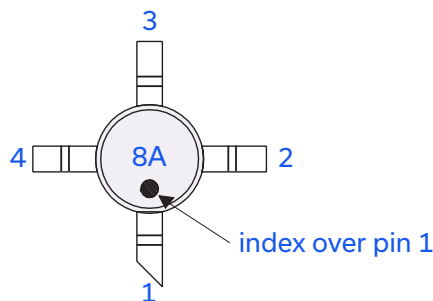

Markings in addition to model number designation may appear for internal quality control purposes.



SURFACE MOUNT

# Monolithic Amplifier

## MAR-8ASM+

50Ω DC to 1 GHz

### RECOMMENDED APPLICATION CIRCUIT

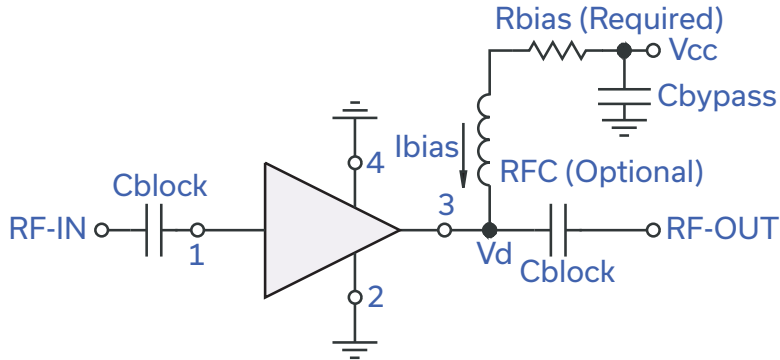

Test Board includes case, connectors, and components (in bold) soldered to PCB

R BIAS <sup>5</sup>	
Vcc	Bias Resistor Value <sup>6</sup>
7	88.7
8	118
9	143
10	174
11	200
12	226
13	255
14	280
15	309

5. When being used as a substitute for MAR-8SM or MSA-0866, the bias resistor values must be changed to the values in this table.

6. 1% Resistor values (ohms) for optimum bias.



SURFACE MOUNT

# Monolithic Amplifier

## MAR-8ASM+

50Ω DC to 1 GHz

ADDITIONAL DETAILED INFORMATION IS AVAILABLE ON OUR DASH BOARD [CLICK HERE](#)

Performance Data & Graphs	Data Graphs S-Parameter (S2P Files) Data Set (.zip file)
Case Style	WW107
RoHS Status	Compliant
Tape & Reel:	F4 7" Reels with 20, 50, 100, 200, 500, 1K devices
Suggested Layout for PCB Design:	PL-253
Evaluation Board	TB-411-8A+
Environmental Ratings	ENV08T3

### ESD RATING

Human Body Model (HBM): Class 2 (2000 v to < 4000 v) in accordance with ANSI/ESD STM 5.1 - 2001

### MSL RATING

Moisture Sensitivity: MSL1 in accordance with IPC/JEDECJ-STD-020C

#### NOTES

- A. Performance and quality attributes and conditions not expressly stated in this specification document are intended to be excluded and do not form a part of this specification document.
- B. Electrical specifications and performance data contained in this specification document are based on Mini-Circuit's applicable established test performance criteria and measurement instructions.
- C. The parts covered by this specification document are subject to Mini-Circuits standard limited warranty and terms and conditions (collectively, "Standard Terms"); Purchasers of this part are entitled to the rights and benefits contained therein. For a full statement of the standard terms and the exclusive rights and remedies thereunder, please visit Mini-Circuits' website at [www.minicircuits.com/terms/viewterm.html](http://www.minicircuits.com/terms/viewterm.html)



# MMIC Amplifier

# MAR-8ASM+

## Typical Performance Data

**NOTE: Use PDF Bookmarks to view DATA at required conditions  
or to view GRAPHS.**

### Definitions:

Input Return Loss = -S11 (dB)

Gain(Power Gain) = S21 (dB)

Reverse Isolation = -S12 (dB)

Output Return Loss = -S22 (dB)

TEST CONDITIONS: I<sub>cc</sub>=36mA; V<sub>cc</sub>=3.97V@Temp.=+25degC

FREQ	Gain	Isolation	Input Return Loss	Output Return Loss	Stability		IP3 Output	1dB Comp. Output	Noise Figure
					K	Delta			
(MHz)	(dB)	(dB)	(dB)	(dB)	K	Delta	(dBm)	(dBm)	(dB)
50	31.43	34.52	15.52	12.46	1.04	0.74	26.36	12.85	2.13
60	31.50	34.53	15.95	12.54	1.04	0.74	26.45	12.91	2.17
80	31.37	34.43	15.47	12.61	1.04	0.74	26.70	12.84	2.20
100	31.34	34.46	15.08	12.65	1.04	0.74	26.46	12.80	2.26
120	31.23	34.26	16.14	12.68	1.04	0.74	26.22	12.72	2.27
140	31.12	34.40	15.51	12.71	1.05	0.72	25.93	12.64	2.25
160	30.87	34.30	16.55	12.75	1.05	0.71	25.69	12.63	2.31
180	30.83	34.21	15.57	12.83	1.05	0.71	25.74	12.55	2.28
200	30.66	34.15	16.03	12.87	1.06	0.70	25.98	12.65	2.28
220	30.51	34.09	16.32	12.98	1.06	0.69	26.13	12.74	2.36
240	30.37	33.95	16.36	13.01	1.06	0.69	25.95	12.72	2.36
260	30.17	33.96	16.06	13.10	1.07	0.67	26.00	12.64	2.41
280	29.96	33.80	15.82	13.16	1.07	0.67	26.02	12.56	2.46
300	29.82	33.75	16.13	13.19	1.07	0.66	25.79	12.38	2.55
320	29.63	33.62	15.92	13.26	1.08	0.66	25.69	12.49	2.51
340	29.44	33.52	16.23	13.33	1.08	0.65	25.67	12.60	2.54
360	29.25	33.39	16.19	13.40	1.08	0.64	25.60	12.59	2.61
380	29.07	33.24	16.23	13.45	1.08	0.64	25.60	12.60	2.62
400	28.89	33.16	16.64	13.55	1.09	0.63	25.53	12.55	2.63
420	28.71	32.95	16.47	13.60	1.08	0.63	25.43	12.54	2.64
440	28.47	32.82	16.47	13.67	1.09	0.62	25.39	12.63	2.63
460	28.32	32.70	16.56	13.76	1.09	0.62	25.59	12.62	2.71
480	28.15	32.54	16.43	13.82	1.09	0.62	25.55	12.58	2.71
500	27.96	32.40	16.78	13.91	1.09	0.61	25.68	12.63	2.76
520	27.78	32.24	16.20	13.90	1.09	0.61	25.79	12.67	2.73
540	27.58	32.01	16.37	13.96	1.09	0.61	25.85	12.69	2.76
560	27.43	31.89	16.42	14.04	1.09	0.60	25.81	12.68	2.82
580	27.24	31.74	16.74	14.04	1.09	0.60	25.82	12.68	2.79
600	27.10	31.56	16.50	14.11	1.09	0.60	25.94	12.72	2.81
620	26.88	31.40	16.32	14.12	1.09	0.59	25.97	12.74	2.81
640	26.72	31.25	16.61	14.19	1.09	0.59	25.91	12.71	2.78
660	26.58	31.07	16.70	14.16	1.09	0.59	26.06	12.68	2.85
680	26.39	30.85	16.78	14.22	1.08	0.60	26.13	12.75	2.84
700	26.20	30.73	16.42	14.22	1.08	0.59	26.19	12.77	2.83
750	25.82	30.29	16.63	14.37	1.08	0.59	26.04	12.82	2.81
800	25.42	29.88	16.83	14.31	1.08	0.59	25.90	12.76	2.88
850	25.04	29.50	16.78	14.30	1.07	0.59	25.76	12.82	2.86
900	24.65	29.08	16.80	14.32	1.07	0.58	25.35	12.73	2.84
940	24.29	28.71	17.07	14.27	1.07	0.58	25.52	12.81	2.92
1000	23.95	28.33	16.83	14.17	1.06	0.58	25.65	12.78	2.87

REV. X1  
MAR-8ASM+  
070829  
Page 1 of 11



IF/RF MICROWAVE COMPONENTS • ISO 9001 ISO 14001 AS 9100 CERTIFIED • RoHS compliant  
P.O. Box 350166, Brooklyn, New York 11235-0003 (718) 934-4500 Fax (718) 332-4661



The Design Engineers Search Engine finds the model you need, Instantly • For detailed performance specs & shopping online see



# MMIC Amplifier

# MAR-8ASM+

## Typical Performance Data

### Definitions:

Input Return Loss = -S11 (dB)

Gain(Power Gain) = S21 (dB)

Reverse Isolation = -S12 (dB)

Output Return Loss = -S22 (dB)

TEST CONDITIONS: Icc=29mA; Vcc=3.87V@Temp.=+25degC

FREQ	Gain	Isolation	Input Return Loss	Output Return Loss	Stability		IP3 Output	1dB Comp. Output	Noise Figure
					K	Delta			
(MHz)	(dB)	(dB)	(dB)	(dB)	K	Delta	(dBm)	(dBm)	(dB)
50	30.34	33.78	12.12	9.83	1.04	0.75	24.75	11.10	2.14
60	30.47	33.87	12.82	9.88	1.04	0.75	24.92	11.17	2.15
80	30.33	33.96	12.37	9.95	1.05	0.73	25.19	11.10	2.17
100	30.33	33.84	12.33	10.01	1.04	0.74	24.87	11.03	2.24
120	30.24	33.71	12.87	10.07	1.04	0.74	24.64	10.77	2.23
140	30.14	33.72	12.89	10.12	1.04	0.73	24.35	10.63	2.22
160	29.95	33.68	13.71	10.14	1.05	0.71	24.09	10.57	2.28
180	29.90	33.60	12.95	10.19	1.04	0.72	24.05	10.48	2.24
200	29.74	33.52	13.13	10.29	1.05	0.71	24.27	10.66	2.27
220	29.62	33.53	13.50	10.35	1.05	0.69	24.43	10.82	2.31
240	29.48	33.44	13.51	10.38	1.05	0.69	24.21	10.85	2.33
260	29.32	33.29	13.35	10.49	1.05	0.68	24.27	10.62	2.38
280	29.15	33.24	13.37	10.56	1.05	0.67	24.22	10.41	2.47
300	29.05	33.13	13.71	10.59	1.05	0.67	23.87	10.22	2.51
320	28.87	33.03	13.75	10.69	1.06	0.66	23.82	10.49	2.50
340	28.71	32.96	13.97	10.78	1.06	0.65	23.70	10.55	2.53
360	28.55	32.82	13.89	10.88	1.06	0.65	23.63	10.58	2.57
380	28.38	32.69	13.94	10.95	1.06	0.64	23.63	10.65	2.58
400	28.21	32.58	14.26	11.06	1.06	0.63	23.59	10.57	2.59
420	28.06	32.41	14.27	11.13	1.06	0.63	23.45	10.44	2.62
440	27.86	32.27	14.35	11.21	1.06	0.63	23.41	10.52	2.60
460	27.73	32.17	14.47	11.33	1.06	0.62	23.62	10.52	2.69
480	27.58	32.02	14.47	11.39	1.06	0.62	23.62	10.47	2.69
500	27.41	31.90	14.75	11.49	1.07	0.61	23.75	10.58	2.72
520	27.25	31.75	14.34	11.54	1.06	0.61	23.90	10.62	2.73
540	27.06	31.56	14.55	11.65	1.06	0.61	24.01	10.77	2.71
560	26.94	31.41	14.72	11.78	1.06	0.61	23.96	10.57	2.73
580	26.77	31.25	14.95	11.82	1.06	0.60	23.99	10.65	2.77
600	26.65	31.11	14.78	11.89	1.06	0.60	24.18	10.81	2.79
620	26.44	30.93	14.73	11.96	1.06	0.60	24.24	10.73	2.79
640	26.31	30.81	14.93	12.08	1.06	0.60	24.15	10.70	2.77
660	26.16	30.63	15.12	12.10	1.06	0.60	24.26	10.70	2.78
680	26.00	30.43	15.17	12.21	1.06	0.60	24.41	10.67	2.81
700	25.85	30.31	15.00	12.26	1.06	0.60	24.63	10.79	2.80
750	25.48	29.92	15.21	12.41	1.05	0.59	24.71	11.05	2.80
800	25.12	29.50	15.39	12.50	1.05	0.59	24.50	10.77	2.81
850	24.75	29.14	15.48	12.65	1.05	0.59	24.62	11.05	2.86
900	24.38	28.74	15.55	12.74	1.04	0.59	24.41	11.24	2.84
940	24.07	28.37	15.78	12.77	1.04	0.59	24.41	11.07	2.89
1000	23.73	28.03	15.70	12.88	1.04	0.59	24.81	11.17	2.84

REV. X1  
MAR-8ASM+  
070829  
Page 2 of 11



IF/RF MICROWAVE COMPONENTS • ISO 9001 ISO 14001 AS 9100 CERTIFIED • RoHS compliant  
P.O. Box 350166, Brooklyn, New York 11235-0003 (718) 934-4500 Fax (718) 332-4661



The Design Engineers Search Engine finds the model you need, Instantly • For detailed performance specs & shopping online see



# MMIC Amplifier

# MAR-8ASM+

## Typical Performance Data

### Definitions:

Input Return Loss = -S11 (dB)

Gain(Power Gain) = S21 (dB)

Reverse Isolation = -S12 (dB)

Output Return Loss = -S22 (dB)

TEST CONDITIONS: Icc=43mA; Vcc=4.05V@Temp.=+25degC

FREQ	Gain	Isolation	Input Return Loss	Output Return Loss	Stability		IP3 Output	1dB Comp. Output	Noise Figure
					K	Delta			
(MHz)	(dB)	(dB)	(dB)	(dB)	K	Delta	(dBm)	(dBm)	(dB)
50	32.14	34.94	18.00	14.96	1.04	0.75	27.84	13.78	2.16
60	32.18	34.77	19.49	15.04	1.03	0.76	27.96	13.75	2.17
80	32.03	34.91	18.34	15.08	1.04	0.74	28.19	13.69	2.22
100	32.01	34.73	17.44	15.24	1.04	0.75	27.92	13.68	2.29
120	31.86	34.85	18.61	15.27	1.05	0.73	27.70	13.70	2.32
140	31.74	34.87	18.22	15.27	1.05	0.72	27.44	13.82	2.29
160	31.47	34.69	19.59	15.25	1.06	0.71	27.24	13.86	2.31
180	31.44	34.62	17.74	15.35	1.06	0.71	27.31	13.74	2.29
200	31.25	34.56	17.98	15.39	1.06	0.70	27.55	13.62	2.29
220	31.06	34.44	19.01	15.51	1.06	0.69	27.65	13.62	2.38
240	30.90	34.36	18.33	15.49	1.07	0.69	27.49	13.59	2.39
260	30.70	34.27	18.22	15.57	1.07	0.68	27.51	13.69	2.43
280	30.48	34.17	17.86	15.58	1.07	0.67	27.64	13.84	2.49
300	30.32	34.14	18.05	15.53	1.08	0.66	27.48	13.86	2.58
320	30.11	33.97	17.86	15.57	1.08	0.66	27.39	13.76	2.55
340	29.91	33.87	18.09	15.65	1.09	0.65	27.33	13.66	2.55
360	29.71	33.74	18.06	15.69	1.09	0.64	27.23	13.54	2.64
380	29.51	33.59	17.76	15.67	1.09	0.64	27.18	13.56	2.64
400	29.29	33.46	18.08	15.75	1.09	0.63	27.07	13.66	2.65
420	29.10	33.30	17.92	15.73	1.09	0.63	26.96	13.70	2.67
440	28.87	33.13	17.86	15.72	1.10	0.62	26.93	13.68	2.67
460	28.69	32.99	17.90	15.77	1.10	0.62	27.08	13.65	2.72
480	28.51	32.82	17.70	15.82	1.10	0.62	27.01	13.60	2.75
500	28.30	32.68	18.03	15.84	1.10	0.61	27.08	13.58	2.77
520	28.12	32.52	17.34	15.81	1.10	0.61	27.11	13.55	2.78
540	27.88	32.32	17.70	15.74	1.10	0.60	27.11	13.51	2.79
560	27.72	32.18	17.61	15.79	1.10	0.60	27.04	13.52	2.86
580	27.54	32.00	17.90	15.70	1.10	0.60	27.02	13.51	2.83
600	27.38	31.82	17.51	15.74	1.10	0.60	27.10	13.52	2.83
620	27.15	31.65	17.39	15.70	1.10	0.60	27.05	13.55	2.85
640	27.00	31.48	17.50	15.72	1.10	0.60	27.01	13.57	2.82
660	26.84	31.30	17.69	15.64	1.10	0.60	27.16	13.57	2.88
680	26.62	31.12	17.78	15.67	1.10	0.59	27.15	13.56	2.86
700	26.45	30.96	17.57	15.59	1.10	0.59	27.06	13.51	2.83
750	26.04	30.51	17.52	15.63	1.09	0.59	26.79	13.32	2.86
800	25.62	30.08	17.81	15.47	1.09	0.59	26.68	13.54	2.89
850	25.24	29.67	17.80	15.39	1.08	0.59	26.34	13.35	2.92
900	24.83	29.27	17.72	15.25	1.08	0.59	25.85	13.12	2.87
940	24.45	28.87	18.10	15.10	1.08	0.59	26.13	13.41	2.94
1000	24.11	28.47	17.76	14.98	1.07	0.59	26.05	13.26	2.93

REV. X1  
MAR-8ASM+  
070829  
Page 3 of 11



IF/RF MICROWAVE COMPONENTS • ISO 9001 ISO 14001 AS 9100 CERTIFIED • RoHS compliant  
P.O. Box 350166, Brooklyn, New York 11235-0003 (718) 934-4500 Fax (718) 332-4661



The Design Engineers Search Engine finds the model you need, Instantly • For detailed performance specs & shopping online see



# MMIC Amplifier

# MAR-8ASM+

## Typical Performance Data

### Definitions:

Input Return Loss = -S11 (dB)

Gain(Power Gain) = S21 (dB)

Reverse Isolation = -S12 (dB)

Output Return Loss = -S22 (dB)

TEST CONDITIONS: Icc=36mA; Vcc=3.95V@Temp.= -45degC

FREQ	Gain	Isolation	Input Return Loss	Output Return Loss	Stability		IP3 Output	1dB Comp. Output	Noise Figure
					K	Delta			
(MHz)	(dB)	(dB)	(dB)	(dB)	K	Delta	(dBm)	(dBm)	(dB)
50	31.88	34.86	17.33	14.04	1.05	0.74	25.74	13.09	1.76
60	31.94	34.75	17.40	14.13	1.04	0.75	25.72	13.14	1.79
80	31.79	34.60	17.53	14.05	1.04	0.75	25.82	13.05	1.81
100	31.77	34.66	16.77	14.21	1.04	0.74	25.61	13.01	1.90
120	31.64	34.72	17.67	14.25	1.05	0.73	25.50	12.89	1.88
140	31.55	34.55	17.61	14.32	1.05	0.73	25.31	12.84	1.86
160	31.30	34.53	19.02	14.34	1.05	0.71	25.21	12.82	1.91
180	31.26	34.33	17.58	14.43	1.05	0.72	25.33	12.75	1.89
200	31.08	34.32	17.35	14.48	1.05	0.71	25.62	12.91	1.97
220	30.91	34.27	18.50	14.58	1.06	0.70	25.85	12.97	1.94
240	30.77	34.13	18.11	14.55	1.06	0.70	25.72	12.87	1.95
260	30.58	34.07	17.64	14.65	1.06	0.69	25.74	12.90	2.01
280	30.38	34.01	17.58	14.69	1.07	0.68	25.75	12.77	2.05
300	30.22	33.87	18.09	14.67	1.07	0.67	25.61	12.62	2.09
320	30.05	33.78	17.59	14.74	1.07	0.67	25.62	12.78	2.07
340	29.86	33.65	18.21	14.83	1.07	0.66	25.64	12.88	2.09
360	29.67	33.55	18.04	14.89	1.08	0.65	25.62	12.83	2.17
380	29.49	33.38	17.84	14.93	1.08	0.65	25.62	12.92	2.18
400	29.28	33.20	18.60	15.03	1.08	0.65	25.57	12.87	2.18
420	29.11	33.08	18.15	15.04	1.08	0.64	25.50	12.89	2.19
440	28.89	32.94	18.11	15.10	1.08	0.64	25.48	12.89	2.20
460	28.72	32.80	18.18	15.21	1.08	0.63	25.67	12.92	2.24
480	28.54	32.64	18.07	15.26	1.08	0.63	25.66	12.89	2.28
500	28.37	32.48	18.44	15.34	1.09	0.63	25.79	12.95	2.29
520	28.20	32.34	17.71	15.34	1.08	0.63	25.94	12.99	2.29
540	27.96	32.12	17.87	15.31	1.08	0.62	25.96	13.01	2.27
560	27.82	31.98	17.88	15.39	1.08	0.62	25.93	13.00	2.32
580	27.65	31.80	18.22	15.32	1.08	0.62	25.97	12.97	2.34
600	27.51	31.60	18.03	15.37	1.08	0.63	26.11	13.08	2.33
620	27.28	31.45	17.86	15.38	1.08	0.62	26.11	13.07	2.31
640	27.13	31.28	18.23	15.45	1.08	0.62	26.06	13.00	2.29
660	26.97	31.12	18.29	15.43	1.08	0.62	26.22	13.02	2.35
680	26.77	30.93	18.39	15.49	1.08	0.62	26.32	13.07	2.33
700	26.61	30.75	17.98	15.45	1.08	0.62	26.39	13.11	2.31
750	26.22	30.37	18.05	15.44	1.07	0.61	26.33	13.24	2.34
800	25.82	29.89	18.27	15.32	1.07	0.62	26.24	13.11	2.40
850	25.44	29.51	18.32	15.31	1.07	0.62	26.16	13.25	2.36
900	25.05	29.08	18.31	15.25	1.06	0.62	25.82	13.25	2.33
940	24.71	28.71	18.58	15.10	1.06	0.62	25.99	13.23	2.40
1000	24.37	28.34	18.37	15.02	1.05	0.62	26.17	13.22	2.37

REV. X1  
MAR-8ASM+  
070829  
Page 4 of 11



IF/RF MICROWAVE COMPONENTS • ISO 9001 ISO 14001 AS 9100 CERTIFIED • RoHS compliant

P.O. Box 350166, Brooklyn, New York 11235-0003 (718) 934-4500 Fax (718) 332-4661



The Design Engineers Search Engine finds the model you need, Instantly • For detailed performance specs & shopping online see





# MMIC Amplifier

# MAR-8ASM+

## Typical Performance Data

### Definitions:

Input Return Loss = -S11 (dB)

Gain(Power Gain) = S21 (dB)

Reverse Isolation = -S12 (dB)

Output Return Loss = -S22 (dB)

TEST CONDITIONS: Icc=29mA; Vcc=3.84V@Temp.= -45degC

FREQ	Gain	Isolation	Input Return Loss	Output Return Loss	Stability		IP3 Output	1dB Comp. Output	Noise Figure
					K	Delta			
(MHz)	(dB)	(dB)	(dB)	(dB)	K	Delta	(dBm)	(dBm)	(dB)
50	30.97	34.29	13.77	11.23	1.05	0.74	23.99	11.38	1.74
60	31.06	34.17	14.08	11.34	1.04	0.75	24.02	11.46	1.75
80	30.90	34.10	14.19	11.34	1.04	0.74	24.17	11.33	1.78
100	30.88	34.03	13.91	11.43	1.04	0.75	23.92	11.20	1.84
120	30.78	34.11	14.76	11.46	1.05	0.73	23.78	11.00	1.88
140	30.70	33.99	14.45	11.52	1.04	0.73	23.55	10.71	1.86
160	30.49	33.97	15.24	11.54	1.05	0.71	23.37	10.74	1.88
180	30.45	33.91	14.47	11.62	1.05	0.72	23.41	10.57	1.85
200	30.30	33.80	14.76	11.68	1.05	0.71	23.70	10.78	1.87
220	30.16	33.74	15.25	11.78	1.05	0.70	23.92	11.05	1.92
240	30.03	33.67	15.45	11.80	1.05	0.69	23.76	11.03	1.91
260	29.84	33.58	15.11	11.90	1.05	0.68	23.77	10.90	1.95
280	29.69	33.50	14.95	11.95	1.06	0.68	23.70	10.72	2.03
300	29.56	33.41	15.46	11.95	1.06	0.67	23.47	10.49	2.11
320	29.38	33.28	15.15	12.07	1.06	0.67	23.44	10.68	2.09
340	29.22	33.16	15.68	12.17	1.06	0.66	23.47	10.83	2.10
360	29.06	33.04	15.45	12.28	1.06	0.66	23.47	10.88	2.18
380	28.89	32.93	15.64	12.32	1.06	0.65	23.48	10.95	2.16
400	28.72	32.76	16.07	12.46	1.06	0.65	23.45	10.85	2.14
420	28.55	32.65	15.92	12.49	1.07	0.64	23.35	10.80	2.15
440	28.35	32.51	16.06	12.60	1.07	0.64	23.35	10.84	2.21
460	28.21	32.37	16.18	12.73	1.07	0.63	23.56	10.86	2.23
480	28.06	32.23	16.17	12.80	1.07	0.63	23.57	10.93	2.27
500	27.90	32.07	16.47	12.90	1.07	0.63	23.73	10.93	2.25
520	27.74	31.92	15.87	12.94	1.07	0.63	23.87	10.98	2.25
540	27.52	31.74	15.98	12.97	1.07	0.62	24.01	11.08	2.26
560	27.40	31.58	16.21	13.06	1.07	0.63	23.97	11.07	2.29
580	27.23	31.41	16.47	13.08	1.06	0.62	23.99	10.99	2.31
600	27.10	31.25	16.33	13.15	1.06	0.62	24.19	11.11	2.31
620	26.89	31.08	16.35	13.19	1.06	0.62	24.26	11.09	2.33
640	26.75	30.93	16.61	13.31	1.06	0.62	24.19	11.03	2.27
660	26.62	30.76	16.69	13.35	1.06	0.62	24.29	11.01	2.33
680	26.42	30.60	16.84	13.45	1.06	0.62	24.45	11.12	2.33
700	26.28	30.43	16.58	13.46	1.06	0.62	24.66	11.17	2.32
750	25.92	30.04	16.56	13.63	1.06	0.62	24.84	11.39	2.31
800	25.54	29.62	16.86	13.65	1.05	0.61	24.62	11.16	2.34
850	25.17	29.25	17.02	13.77	1.05	0.61	24.85	11.39	2.35
900	24.80	28.85	17.03	13.82	1.05	0.61	24.71	11.59	2.33
940	24.48	28.46	17.21	13.82	1.04	0.62	24.67	11.44	2.38
1000	24.16	28.11	17.06	13.85	1.04	0.61	25.13	11.56	2.35

REV. X1  
MAR-8ASM+  
070829  
Page 5 of 11



IF/RF MICROWAVE COMPONENTS • ISO 9001 ISO 14001 AS 9100 CERTIFIED • RoHS compliant  
P.O. Box 350166, Brooklyn, New York 11235-0003 (718) 934-4500 Fax (718) 332-4661



The Design Engineers Search Engine finds the model you need, Instantly • For detailed performance specs & shopping online see



# MMIC Amplifier

# MAR-8ASM+

## Typical Performance Data

### Definitions:

Input Return Loss = -S11 (dB)

Gain(Power Gain) = S21 (dB)

Reverse Isolation = -S12 (dB)

Output Return Loss = -S22 (dB)

TEST CONDITIONS: Icc=43mA; Vcc=4.02V@Temp.= -45degC

FREQ	Gain	Isolation	Input Return Loss	Output Return Loss	Stability		IP3 Output	1dB Comp. Output	Noise Figure
					K	Delta			
(MHz)	(dB)	(dB)	(dB)	(dB)	K	Delta	(dBm)	(dBm)	(dB)
50	32.55	35.22	19.79	17.05	1.04	0.75	27.35	14.18	1.78
60	32.57	35.25	20.73	17.11	1.04	0.75	27.27	14.19	1.78
80	32.42	35.13	20.81	17.12	1.04	0.74	27.29	14.14	1.84
100	32.38	35.10	20.82	17.24	1.04	0.74	27.11	14.11	1.94
120	32.24	35.04	21.20	17.24	1.05	0.74	27.02	14.12	1.92
140	32.12	35.01	20.10	17.30	1.05	0.73	26.89	14.07	1.85
160	31.83	34.92	23.03	17.29	1.06	0.71	26.85	14.07	1.95
180	31.80	34.83	20.50	17.35	1.05	0.72	26.99	14.02	1.89
200	31.61	34.73	19.99	17.35	1.06	0.71	27.28	14.06	2.00
220	31.42	34.70	21.39	17.44	1.06	0.70	27.45	14.10	1.96
240	31.25	34.62	20.21	17.36	1.07	0.69	27.35	14.06	1.97
260	31.05	34.52	20.16	17.40	1.07	0.68	27.35	14.08	2.01
280	30.85	34.38	19.60	17.41	1.07	0.68	27.49	14.09	2.05
300	30.68	34.26	19.83	17.33	1.08	0.67	27.43	14.06	2.13
320	30.48	34.16	19.54	17.35	1.08	0.67	27.42	14.14	2.11
340	30.28	34.02	19.92	17.38	1.08	0.66	27.39	14.11	2.14
360	30.06	33.88	19.71	17.40	1.08	0.65	27.30	14.04	2.20
380	29.87	33.75	19.36	17.35	1.09	0.65	27.25	14.11	2.20
400	29.64	33.56	20.02	17.42	1.09	0.64	27.17	14.14	2.22
420	29.46	33.39	19.80	17.35	1.09	0.64	27.08	14.16	2.23
440	29.22	33.25	19.57	17.37	1.09	0.64	27.06	14.21	2.26
460	29.06	33.11	19.68	17.41	1.09	0.63	27.19	14.16	2.26
480	28.87	32.96	19.39	17.43	1.09	0.63	27.12	14.15	2.30
500	28.68	32.76	19.70	17.45	1.09	0.63	27.19	14.18	2.31
520	28.50	32.58	18.72	17.35	1.09	0.63	27.23	14.16	2.29
540	28.26	32.40	19.31	17.27	1.09	0.62	27.24	14.14	2.29
560	28.11	32.21	19.25	17.27	1.09	0.63	27.19	14.13	2.34
580	27.93	32.05	19.36	17.11	1.09	0.62	27.20	14.14	2.34
600	27.76	31.86	18.99	17.09	1.09	0.62	27.27	14.17	2.35
620	27.54	31.69	18.98	17.04	1.09	0.62	27.22	14.16	2.36
640	27.37	31.51	19.18	17.03	1.09	0.62	27.21	14.17	2.33
660	27.20	31.29	19.06	16.94	1.09	0.62	27.35	14.20	2.38
680	27.01	31.12	19.41	16.97	1.09	0.62	27.39	14.22	2.37
700	26.85	30.97	18.97	16.84	1.08	0.62	27.31	14.18	2.34
750	26.43	30.55	19.05	16.74	1.08	0.62	27.04	14.07	2.36
800	26.01	30.10	19.23	16.48	1.08	0.62	27.05	14.21	2.41
850	25.61	29.68	19.31	16.32	1.07	0.62	26.78	14.11	2.38
900	25.21	29.25	19.23	16.13	1.07	0.62	26.35	13.88	2.37
940	24.86	28.87	19.45	15.90	1.07	0.62	26.65	14.15	2.43
1000	24.50	28.49	19.34	15.74	1.06	0.62	26.60	14.00	2.39

REV. X1  
MAR-8ASM+  
070829  
Page 6 of 11



IF/RF MICROWAVE COMPONENTS • ISO 9001 ISO 14001 AS 9100 CERTIFIED • RoHS compliant  
P.O. Box 350166, Brooklyn, New York 11235-0003 (718) 934-4500 Fax (718) 332-4661



The Design Engineers Search Engine finds the model you need, Instantly • For detailed performance specs & shopping online see



# MMIC Amplifier

# MAR-8ASM+

## Typical Performance Data

### Definitions:

Input Return Loss = -S11 (dB)

Gain(Power Gain) = S21 (dB)

Reverse Isolation = -S12 (dB)

Output Return Loss = -S22 (dB)

TEST CONDITIONS: Icc=36mA; Vcc=3.91V@Temp.=+85degC

FREQ	Gain	Isolation	Input Return Loss	Output Return Loss	Stability		IP3 Output	1dB Comp. Output	Noise Figure
					K	Delta			
(MHz)	(dB)	(dB)	(dB)	(dB)	K	Delta	(dBm)	(dBm)	(dB)
50	30.75	33.98	13.16	10.46	1.04	0.75	26.80	12.53	2.54
60	30.82	34.05	13.80	10.55	1.04	0.75	26.91	12.57	2.56
80	30.69	34.12	13.50	10.66	1.05	0.74	27.14	12.52	2.59
100	30.66	34.00	12.90	10.77	1.04	0.74	26.83	12.47	2.65
120	30.55	33.87	13.93	10.83	1.04	0.74	26.54	12.48	2.66
140	30.44	34.00	13.32	10.86	1.05	0.72	26.26	12.54	2.67
160	30.23	33.93	14.10	10.88	1.05	0.70	26.02	12.48	2.68
180	30.17	33.84	13.45	10.97	1.05	0.71	26.00	12.44	2.67
200	30.02	33.75	13.62	11.05	1.05	0.70	26.19	12.45	2.68
220	29.86	33.73	14.09	11.12	1.06	0.69	26.33	12.42	2.76
240	29.72	33.63	14.31	11.15	1.06	0.68	26.16	12.40	2.75
260	29.52	33.61	14.08	11.25	1.07	0.67	26.26	12.40	2.84
280	29.33	33.50	13.76	11.29	1.07	0.66	26.29	12.34	2.89
300	29.18	33.45	14.07	11.35	1.07	0.65	25.98	12.26	2.97
320	29.01	33.27	13.80	11.43	1.07	0.65	25.82	12.31	2.94
340	28.83	33.21	14.53	11.51	1.08	0.64	25.74	12.31	2.95
360	28.66	33.09	14.24	11.61	1.08	0.63	25.66	12.28	3.05
380	28.48	32.98	14.18	11.68	1.08	0.63	25.61	12.28	3.02
400	28.30	32.89	14.62	11.77	1.08	0.61	25.54	12.27	3.05
420	28.11	32.73	14.55	11.84	1.08	0.61	25.45	12.36	3.06
440	27.89	32.57	14.59	11.91	1.09	0.61	25.41	12.29	3.06
460	27.74	32.47	14.67	12.01	1.09	0.60	25.59	12.31	3.12
480	27.57	32.32	14.69	12.10	1.09	0.60	25.56	12.23	3.16
500	27.38	32.17	14.91	12.21	1.09	0.59	25.65	12.30	3.20
520	27.21	32.00	14.41	12.24	1.09	0.59	25.74	12.29	3.17
540	27.00	31.85	14.53	12.33	1.09	0.58	25.82	12.26	3.18
560	26.85	31.70	14.62	12.43	1.09	0.58	25.75	12.27	3.25
580	26.69	31.55	14.84	12.44	1.09	0.58	25.73	12.27	3.24
600	26.54	31.39	14.75	12.53	1.09	0.58	25.86	12.23	3.24
620	26.32	31.20	14.71	12.57	1.09	0.57	25.85	12.26	3.24
640	26.19	31.06	14.77	12.67	1.09	0.57	25.80	12.28	3.24
660	26.04	30.88	14.95	12.67	1.08	0.57	25.94	12.23	3.29
680	25.86	30.71	15.06	12.76	1.08	0.57	25.99	12.27	3.31
700	25.67	30.58	14.87	12.79	1.08	0.56	26.02	12.27	3.26
750	25.32	30.17	14.93	12.91	1.08	0.56	25.83	12.23	3.28
800	24.91	29.74	15.14	12.98	1.07	0.56	25.67	12.27	3.33
850	24.54	29.37	15.20	13.09	1.07	0.56	25.45	12.19	3.32
900	24.15	28.97	15.13	13.13	1.07	0.55	24.99	12.05	3.34
940	23.79	28.58	15.41	13.15	1.07	0.55	25.17	12.22	3.37
1000	23.44	28.22	15.27	13.16	1.06	0.55	25.21	12.11	3.36

REV. X1  
MAR-8ASM+  
070829  
Page 7 of 11



IF/RF MICROWAVE COMPONENTS • ISO 9001 ISO 14001 AS 9100 CERTIFIED • RoHS compliant  
P.O. Box 350166, Brooklyn, New York 11235-0003 (718) 934-4500 Fax (718) 332-4661



The Design Engineers Search Engine finds the model you need, Instantly • For detailed performance specs & shopping online see



# MMIC Amplifier

# MAR-8ASM+

## Typical Performance Data

### Definitions:

Input Return Loss = -S11 (dB)

Gain(Power Gain) = S21 (dB)

Reverse Isolation = -S12 (dB)

Output Return Loss = -S22 (dB)

TEST CONDITIONS: Icc=29mA; Vcc=3.81V@Temp.=+85degC

FREQ	Gain	Isolation	Input Return Loss	Output Return Loss	Stability		IP3 Output	1dB Comp. Output	Noise Figure
					K	Delta			
(MHz)	(dB)	(dB)	(dB)	(dB)	K	Delta	(dBm)	(dBm)	(dB)
50	29.62	33.72	10.65	8.51	1.05	0.73	25.51	10.96	2.53
60	29.76	33.68	11.13	8.57	1.04	0.74	25.62	11.02	2.55
80	29.63	33.57	11.30	8.62	1.05	0.74	25.91	10.90	2.57
100	29.64	33.55	11.04	8.72	1.04	0.74	25.59	10.94	2.64
120	29.57	33.46	11.62	8.76	1.04	0.73	25.28	10.71	2.64
140	29.46	33.36	11.40	8.82	1.04	0.73	24.97	10.51	2.65
160	29.27	33.38	11.99	8.85	1.05	0.71	24.66	10.52	2.65
180	29.21	33.34	11.48	8.93	1.05	0.71	24.59	10.43	2.62
200	29.08	33.26	11.59	8.97	1.05	0.70	24.74	10.46	2.66
220	28.96	33.13	11.98	9.07	1.05	0.69	24.88	10.66	2.74
240	28.82	33.13	11.88	9.08	1.05	0.68	24.65	10.63	2.74
260	28.66	33.00	11.75	9.18	1.05	0.68	24.77	10.59	2.82
280	28.49	33.01	11.80	9.25	1.05	0.66	24.75	10.29	2.85
300	28.38	32.86	12.12	9.30	1.05	0.66	24.33	10.07	2.94
320	28.22	32.76	12.06	9.38	1.05	0.65	24.10	10.34	2.93
340	28.07	32.66	12.51	9.49	1.06	0.64	23.98	10.38	2.94
360	27.91	32.53	12.43	9.58	1.05	0.64	23.87	10.35	3.00
380	27.74	32.45	12.56	9.65	1.06	0.63	23.84	10.44	2.99
400	27.58	32.29	12.81	9.77	1.06	0.62	23.78	10.40	3.01
420	27.44	32.19	12.70	9.86	1.06	0.62	23.65	10.23	3.02
440	27.24	32.05	12.97	9.93	1.06	0.61	23.59	10.31	3.05
460	27.11	31.93	12.96	10.03	1.06	0.61	23.83	10.34	3.14
480	26.96	31.78	13.00	10.11	1.06	0.60	23.80	10.28	3.13
500	26.81	31.64	13.27	10.23	1.06	0.60	23.89	10.32	3.15
520	26.62	31.56	12.88	10.28	1.06	0.59	24.03	10.30	3.18
540	26.45	31.36	13.05	10.30	1.06	0.59	24.14	10.43	3.19
560	26.32	31.23	13.23	10.41	1.06	0.59	24.07	10.42	3.24
580	26.19	31.07	13.43	10.47	1.06	0.58	24.10	10.30	3.23
600	26.04	30.92	13.28	10.58	1.06	0.58	24.28	10.52	3.22
620	25.85	30.77	13.29	10.64	1.06	0.58	24.35	10.49	3.23
640	25.73	30.61	13.50	10.75	1.05	0.58	24.26	10.38	3.22
660	25.56	30.45	13.55	10.79	1.05	0.57	24.34	10.43	3.25
680	25.41	30.29	13.75	10.89	1.05	0.57	24.48	10.48	3.28
700	25.26	30.15	13.57	10.96	1.05	0.57	24.66	10.56	3.23
750	24.90	29.78	13.56	11.25	1.05	0.56	24.68	10.72	3.27
800	24.54	29.35	13.85	11.33	1.04	0.56	24.47	10.55	3.31
850	24.17	28.97	13.98	11.53	1.04	0.56	24.46	10.72	3.33
900	23.82	28.60	13.92	11.68	1.04	0.55	24.19	10.92	3.32
940	23.49	28.23	14.23	11.78	1.04	0.55	24.21	10.83	3.34
1000	23.17	27.87	14.09	11.87	1.03	0.55	24.50	10.89	3.33

REV. X1  
MAR-8ASM+  
070829  
Page 8 of 11



IF/RF MICROWAVE COMPONENTS • ISO 9001 ISO 14001 AS 9100 CERTIFIED • RoHS compliant  
P.O. Box 350166, Brooklyn, New York 11235-0003 (718) 934-4500 Fax (718) 332-4661



The Design Engineers Search Engine finds the model you need, Instantly • For detailed performance specs & shopping online see



# MMIC Amplifier

# MAR-8ASM+

## Typical Performance Data

### Definitions:

Input Return Loss = -S11 (dB)

Gain(Power Gain) = S21 (dB)

Reverse Isolation = -S12 (dB)

Output Return Loss = -S22 (dB)

TEST CONDITIONS: Icc=43mA; Vcc=3.99V@Temp.=+85degC

FREQ	Gain	Isolation	Input Return Loss	Output Return Loss	Stability		IP3 Output	1dB Comp. Output	Noise Figure
					K	Delta			
(MHz)	(dB)	(dB)	(dB)	(dB)	K	Delta	(dBm)	(dBm)	(dB)
50	31.52	34.41	15.29	12.53	1.04	0.76	28.14	13.11	2.58
60	31.57	34.48	16.13	12.61	1.04	0.75	28.21	13.12	2.60
80	31.44	34.46	15.53	12.67	1.04	0.74	28.39	13.08	2.62
100	31.38	34.42	15.02	12.84	1.04	0.74	28.09	13.05	2.70
120	31.27	34.39	16.20	12.89	1.05	0.73	27.83	13.11	2.72
140	31.14	34.34	15.57	12.92	1.05	0.73	27.54	13.24	2.69
160	30.89	34.27	16.67	12.96	1.05	0.71	27.34	13.28	2.70
180	30.84	34.26	15.40	13.04	1.06	0.71	27.37	13.13	2.70
200	30.66	34.22	15.72	13.09	1.06	0.70	27.58	12.92	2.69
220	30.47	34.14	16.32	13.20	1.07	0.68	27.67	12.84	2.77
240	30.32	34.06	16.11	13.20	1.07	0.68	27.49	12.77	2.78
260	30.13	34.02	15.58	13.28	1.07	0.67	27.58	12.88	2.85
280	29.93	33.92	15.72	13.30	1.08	0.66	27.70	13.05	2.92
300	29.77	33.85	15.81	13.31	1.08	0.65	27.51	13.07	2.97
320	29.55	33.72	15.60	13.39	1.08	0.64	27.34	12.94	2.95
340	29.36	33.60	15.99	13.48	1.09	0.64	27.26	12.81	2.98
360	29.16	33.54	15.82	13.56	1.09	0.62	27.11	12.71	3.05
380	28.96	33.40	15.78	13.58	1.10	0.62	27.06	12.77	3.06
400	28.76	33.23	16.25	13.67	1.10	0.61	26.96	12.87	3.09
420	28.58	33.11	16.10	13.72	1.10	0.61	26.84	12.86	3.08
440	28.35	32.98	15.93	13.77	1.10	0.60	26.80	12.86	3.10
460	28.18	32.80	16.03	13.82	1.10	0.60	26.95	12.81	3.16
480	27.99	32.68	15.94	13.90	1.10	0.59	26.85	12.81	3.19
500	27.79	32.50	16.16	13.98	1.11	0.59	26.92	12.76	3.22
520	27.60	32.37	15.56	13.99	1.10	0.59	26.95	12.72	3.22
540	27.40	32.20	15.76	13.99	1.10	0.58	26.94	12.72	3.23
560	27.22	32.01	15.84	14.04	1.10	0.58	26.88	12.71	3.29
580	27.03	31.85	15.99	14.02	1.10	0.58	26.87	12.69	3.26
600	26.88	31.69	15.78	14.09	1.10	0.58	26.89	12.68	3.28
620	26.66	31.52	15.74	14.10	1.10	0.57	26.85	12.71	3.28
640	26.50	31.35	15.81	14.16	1.10	0.57	26.79	12.75	3.26
660	26.33	31.16	15.92	14.12	1.10	0.57	26.91	12.77	3.32
680	26.13	30.98	16.09	14.17	1.10	0.57	26.91	12.76	3.32
700	25.99	30.86	15.85	14.18	1.10	0.57	26.83	12.71	3.29
750	25.57	30.41	15.92	14.26	1.10	0.56	26.49	12.57	3.29
800	25.13	29.99	16.05	14.15	1.09	0.56	26.36	12.73	3.38
850	24.75	29.59	16.09	14.21	1.09	0.56	25.99	12.54	3.37
900	24.35	29.19	16.01	14.17	1.09	0.55	25.47	12.31	3.35
940	23.98	28.81	16.30	14.11	1.08	0.55	25.69	12.57	3.38
1000	23.62	28.42	16.07	14.05	1.08	0.55	25.64	12.43	3.38

REV. X1  
MAR-8ASM+  
070829  
Page 9 of 11



IF/RF MICROWAVE COMPONENTS • ISO 9001 ISO 14001 AS 9100 CERTIFIED • RoHS compliant

P.O. Box 350166, Brooklyn, New York 11235-0003 (718) 934-4500 Fax (718) 332-4661



The Design Engineers Search Engine finds the model you need, Instantly • For detailed performance specs & shopping online see



## Typical Performance Curves

**GAIN vs. TEMPERATURE**

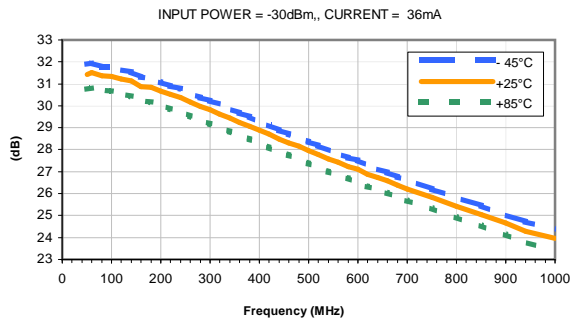

**GAIN vs. CURRENT**

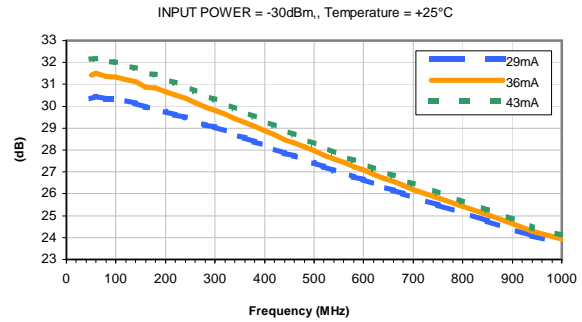

**ISOLATION vs. TEMPERATURE**

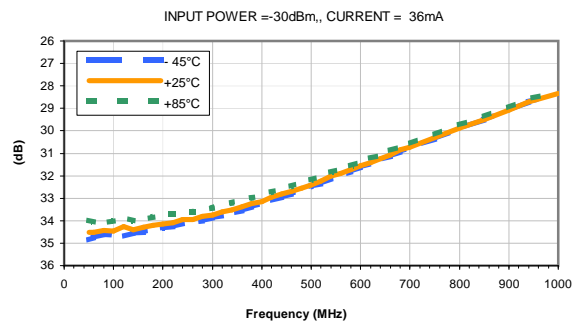

**ISOLATION vs. CURRENT**

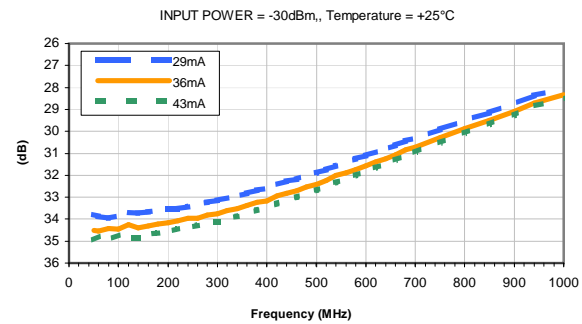

**INPUT RETURN LOSS vs. TEMPERATURE**

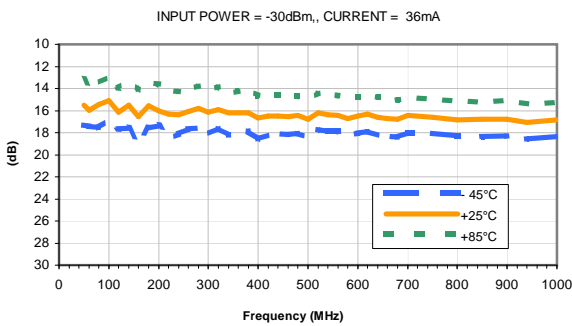

**INPUT RETURN LOSS vs. CURRENT**

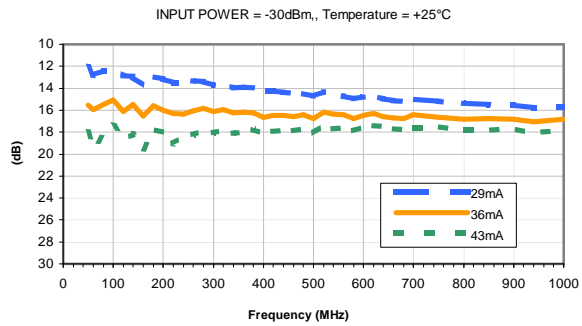

**OUTPUT RETURN LOSS vs. TEMPERATURE**

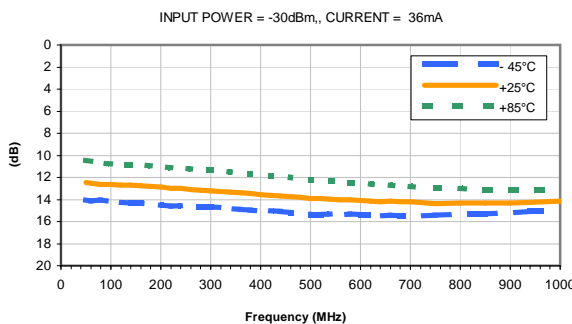

**OUTPUT RETURN LOSS vs. CURRENT**

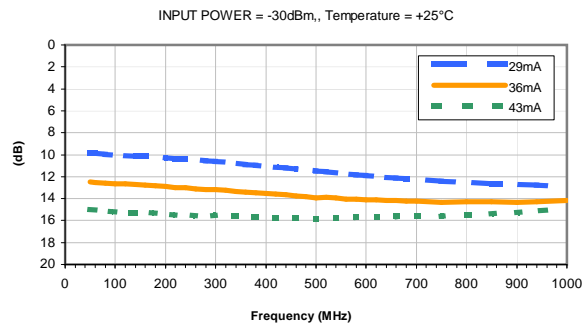

## Typical Performance Curves

OUTPUT IP3 vs. TEMPERATURE

INPUT POWER = -30dBm, CURRENT = 36mA

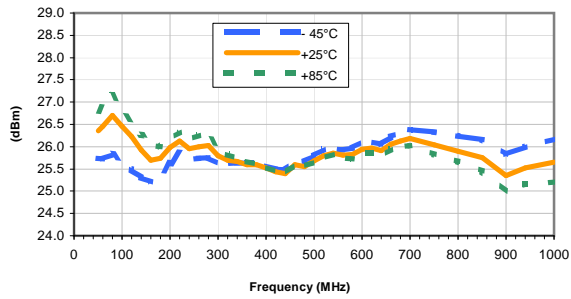

OUTPUT IP-3 vs. CURRENT

INPUT POWER = -30dBm, Temperature = +25°C

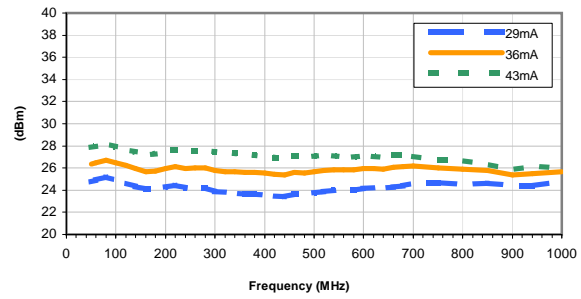

OUTPUT POWER at 1dB Compression vs. TEMPERATURE

CURRENT = 36mA

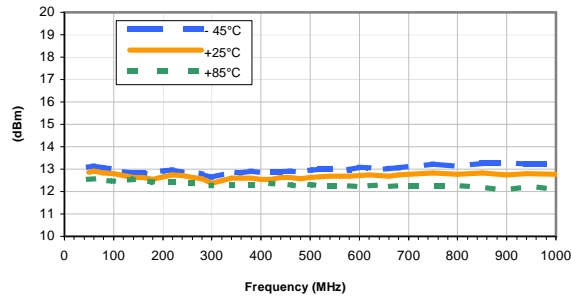

OUTPUT POWER at 1dB Compression vs. CURRENT

Temperature = +25°C

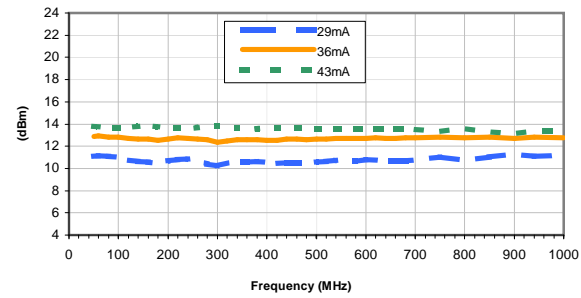

Noise Figure vs. TEMPERATURE

CURRENT = 36mA

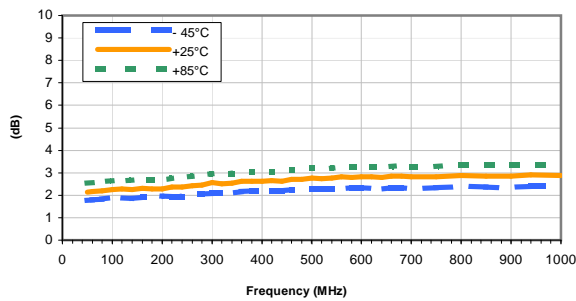

Noise Figure vs. CURRENT

Temperature = +25°C

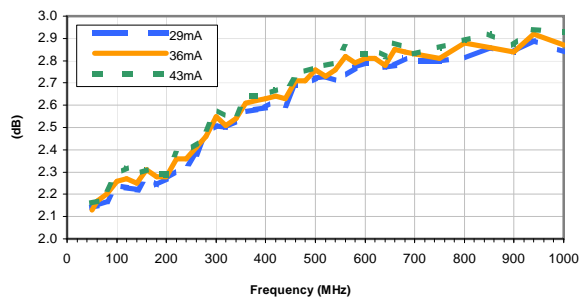

IF/RF MICROWAVE COMPONENTS • ISO 9001 ISO 14001 AS 9100 CERTIFIED • RoHS compliant  
 P.O. Box 350166, Brooklyn, New York 11235-0003 (718) 934-4500 Fax (718) 332-4661



The Design Engineers Search Engine finds the model you need, Instantly • For detailed performance specs & shopping online see





## Typical Performance Curves

**GAIN vs. TEMPERATURE**

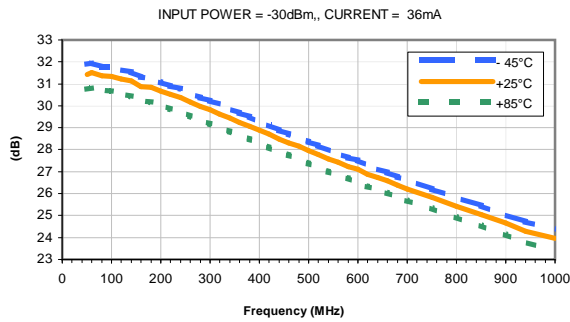

**GAIN vs. CURRENT**

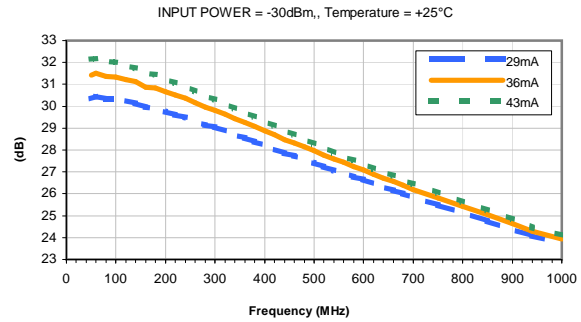

**ISOLATION vs. TEMPERATURE**

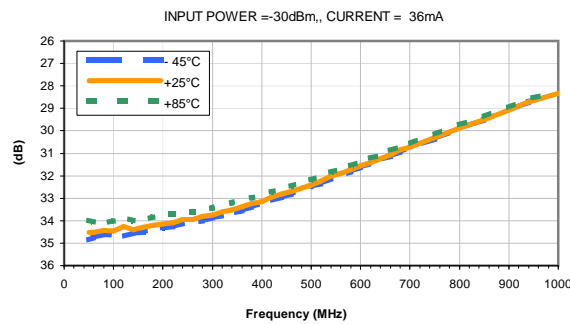

**ISOLATION vs. CURRENT**

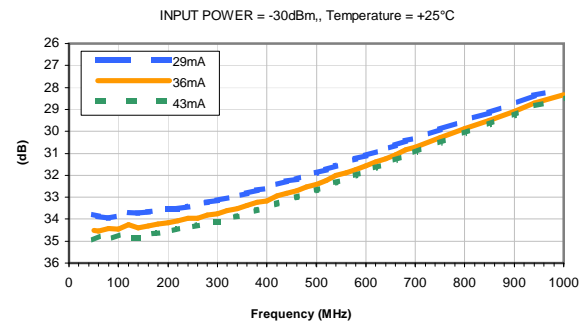

**INPUT RETURN LOSS vs. TEMPERATURE**

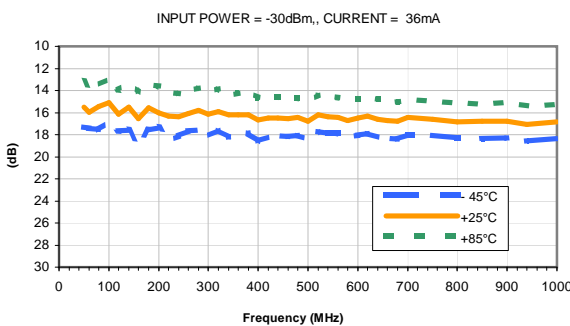

**INPUT RETURN LOSS vs. CURRENT**

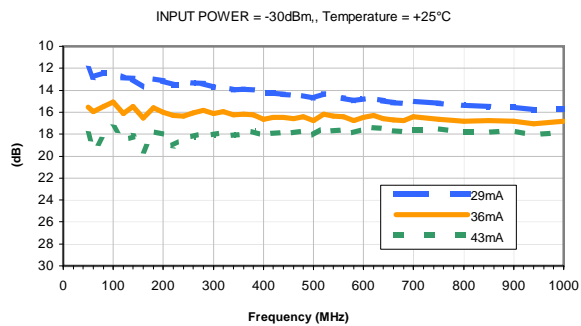

**OUTPUT RETURN LOSS vs. TEMPERATURE**

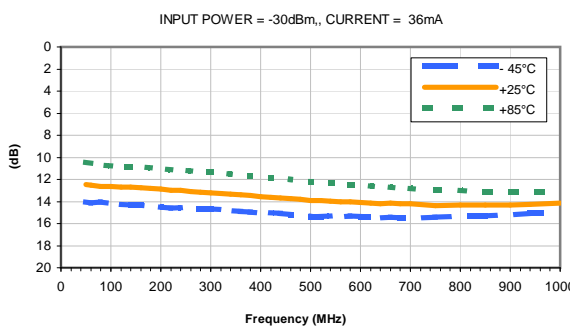

**OUTPUT RETURN LOSS vs. CURRENT**

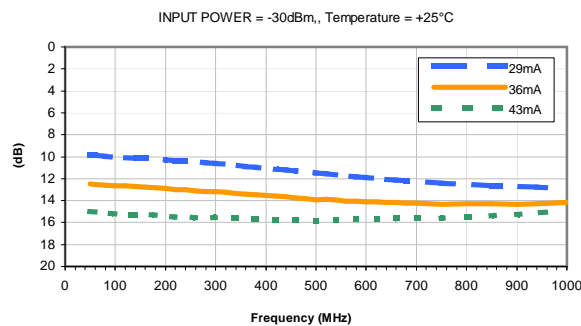



## Typical Performance Curves

**OUTPUT IP3 vs. TEMPERATURE**

INPUT POWER = -30dBm, CURRENT = 36mA

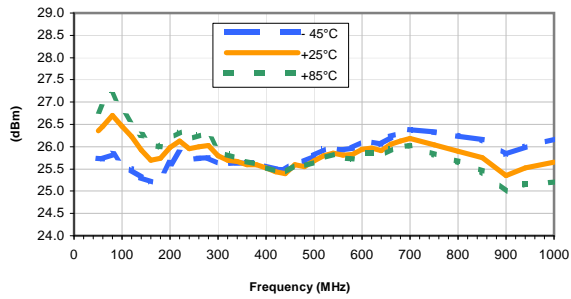

**OUTPUT IP-3 vs. CURRENT**

INPUT POWER = -30dBm, Temperature = +25°C

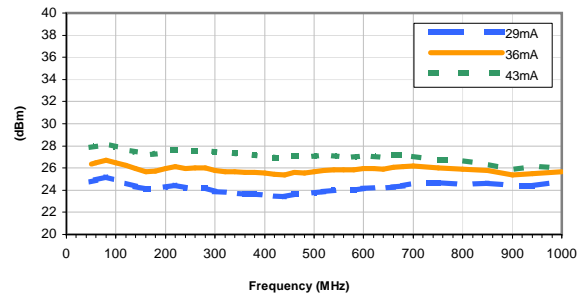

**OUTPUT POWER at 1dB Compression vs. TEMPERATURE**

CURRENT = 36mA

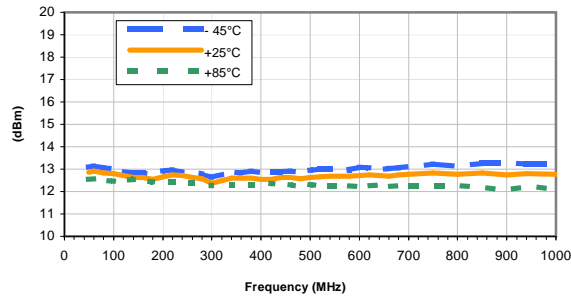

**OUTPUT POWER at 1dB Compression vs. CURRENT**

Temperature = +25°C

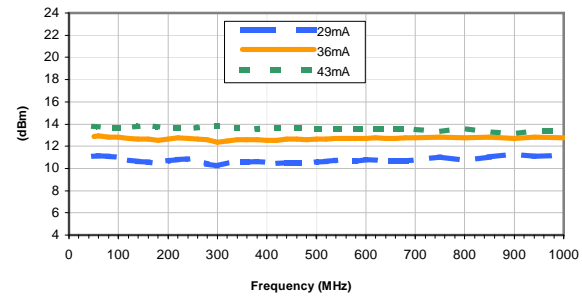

**Noise Figure vs. TEMPERATURE**

CURRENT = 36mA

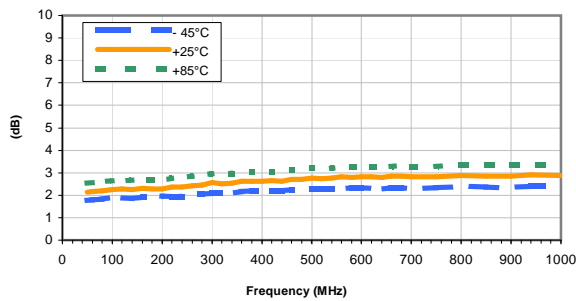

**Noise Figure vs. CURRENT**

Temperature = +25°C

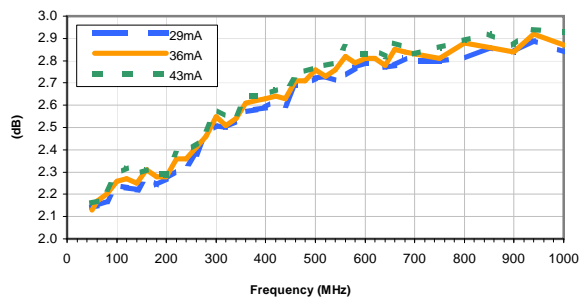

### Outline Dimensions

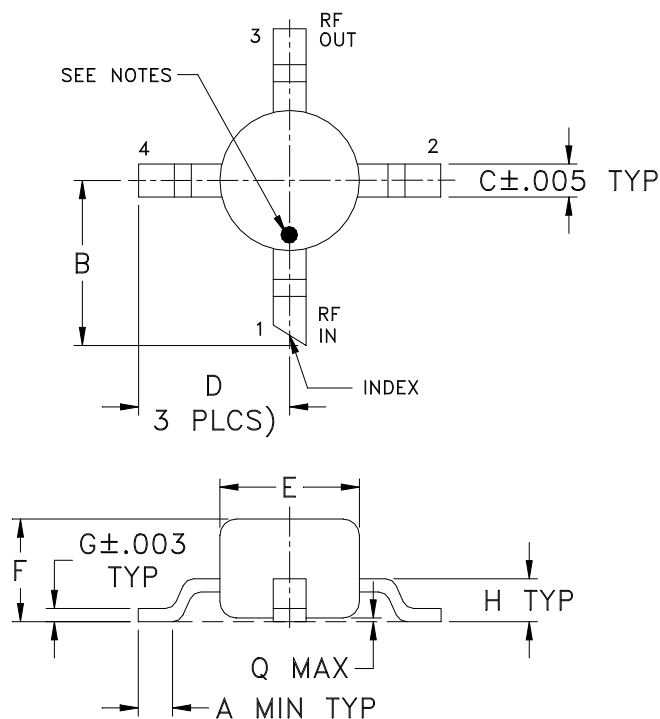

### PCB Land Pattern

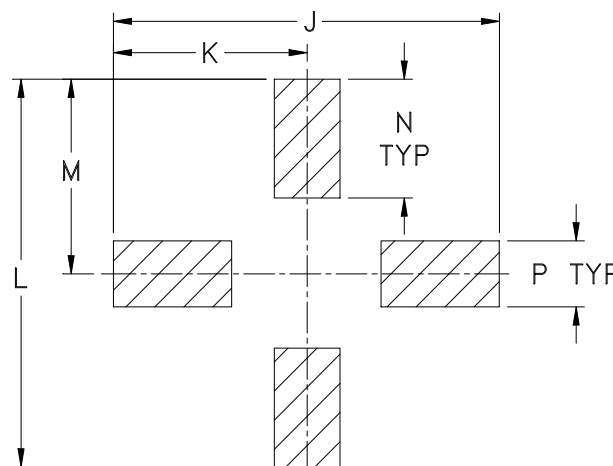

Suggested Layout,  
Tolerance to be within  $\pm.002$

CASE#	A	B	C	D	E	F	G	H	J	K	L	M	N	P	Q	WT. GRAMS
WW107	.012 (0.30)	.10 (2.54)	.020 (0.51)	.092 (2.34)	.085 (2.16)	.060 (1.52)	.007 (0.18)	.026 (0.66)	.235 (5.97)	.118 (3.00)	.235 (5.97)	.118 (3.00)	.072 (1.83)	.040 (1.02)	.020 (0.51)	.015

Dimensions are in inches (mm). Tolerances: 2 Pl.  $\pm .03$ ; 3 Pl.  $\pm .015$

#### Notes:

- Case material: Plastic.
- Termination finish:  
For RoHS Case Styles: Matte tin Plate.  
For RoHS-5 Case Styles: Tin-Lead plate.
- RF input termination (1) identified by one or both of the following at factory option:
  - diagonally cut termination, which may be  $45^\circ$  (ref) in either direction;
  - orientation mark on the case. Model dash number is identified by color dot or alphanumeric code on case. See specification data sheet.



INTERNET <http://www.minicircuits.com>

P.O. Box 350166, Brooklyn, New York 11235-0003 (718) 934-4500

Distribution Centers NORTH AMERICA 800-654-7949 • 417-335-5935 • Fax 417-335-5945 • EUROPE 44-1252-1

Mini-Circuits ISO 9001 & ISO 14001 Certified

# Tape & Reel Packaging TR-F4

## DEVICE ORIENTATION IN T&R

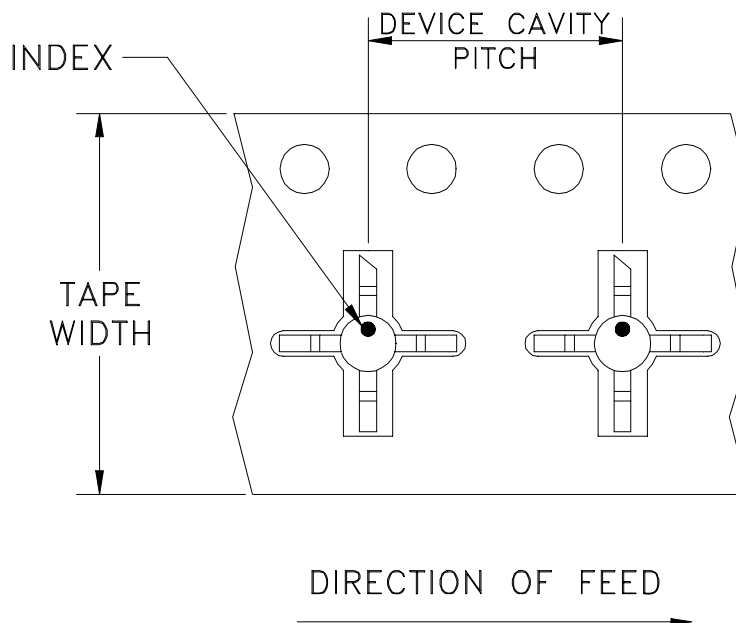

Tape Width, mm	Device Cavity Pitch, mm	Reel Size, inches	Devices per Reel	
12	8	7	Small quantity standards (see note)	20
				50
				100
				200
				500
		7	Standard	1000

Note: Please Consult individual model data sheet to determine device per reel availability.

Mini-Circuits carrier tape materials provide protection from ESD (Electro-Static Discharge) during handling and transportation. Tapes are static dissipative and comply with industry standards EIA-481/EIA-541.

Go to: [www.minicircuits.com/pages/pdfs/tape.pdf](http://www.minicircuits.com/pages/pdfs/tape.pdf)



INTERNET <http://www.minicircuits.com>

P.O. Box 350166, Brooklyn, New York 11235-0003 (718) 934-4500 Fax (718) 332-4661

Distribution Centers NORTH AMERICA 800-654-7949 • 417-335-5935 • Fax 417-335-5945 • EUROPE 44-1252-832600 • Fax 44-1252-837010

Mini-Circuits ISO 9001 & ISO 14001 Certified

THIRD ANGLE PROJECTION

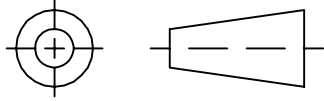

REVISIONS

REV	ECN No.	DESCRIPTION	DATE	DR	AUTH
OR	M108436	NEW RELEASE	11/14/06	PW	IG

SUGGESTED MOUNTING CONFIGURATION FOR WW107 CASE STYLE, "cb" PIN CONNECTION

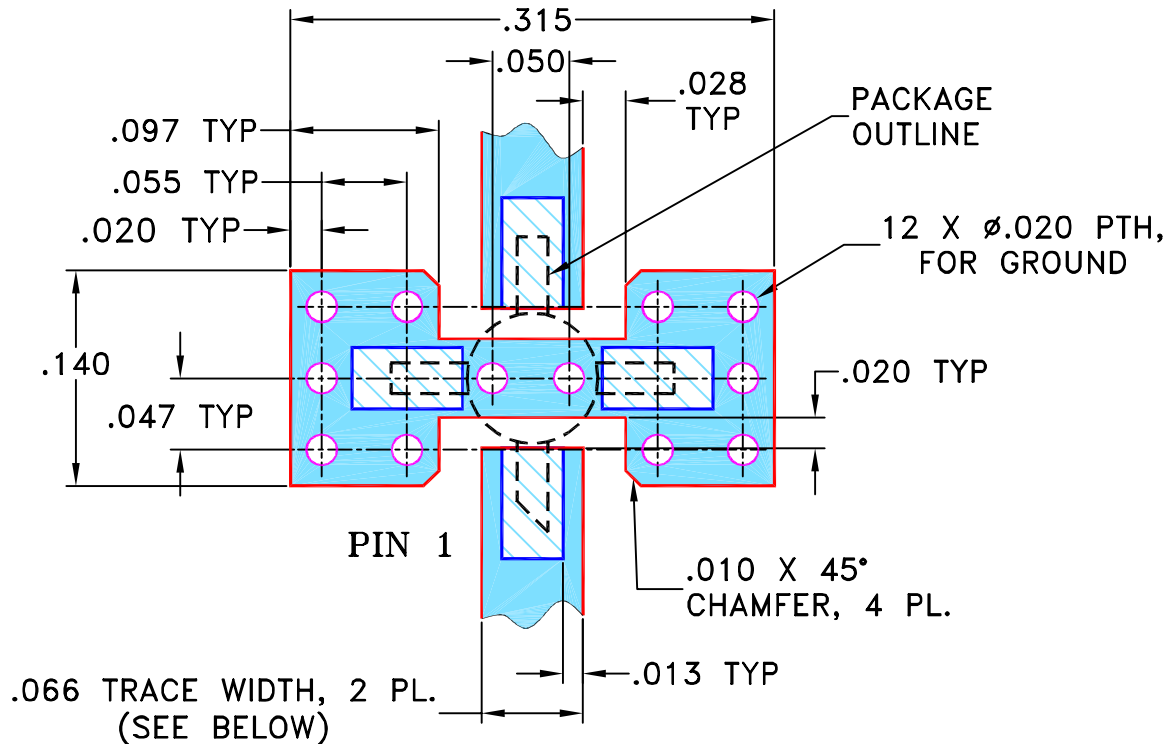

NOTES:

1. TRACE WIDTH IS SHOWN FOR ROGERS R04350B WITH DIELECTRIC THICKNESS .030" ± .002"; COPPER: 1/2 OZ. EACH SIDE. FOR OTHER MATERIALS TRACE WIDTH MAY NEED TO BE MODIFIED.
2. BOTTOM SIDE OF THE PCB IS CONTINUOUS GROUND PLANE.
3. IF PCB DESIGN RULES ALLOW, PLACE GROUND VIAS UNDER THE LAND PATTERN FOR BETTER RF PERFORMANCE. OTHERWISE PLACE GROUND VIAS AS CLOSE TO LAND PATTERN AS POSSIBLE.

- DENOTES PCB COPPER LAYOUT WITH SMOBC (SOLDER MASK OVER BARE COPPER)
- DENOTES COPPER LAND PATTERN FREE OF SOLDER MASK

UNLESS OTHERWISE SPECIFIED	INITIALS	DATE
DIMENSIONS ARE IN INCHES TOLERANCES ON: 2 PL DECIMALS ± 3 PL DECIMALS ± .005 ANGLES ± FRACTIONS ±	DRAWN	PW 11/11/06
	CHECKED	IL 11/14/06
	APPROVED	IG 11/14/06

**Mini-Circuits®** 13 Neptune Avenue  
Brooklyn NY 11235

PL, cb, WW107, MAR, TB-411-XX+

Mini-Circuits®  
 THIS DOCUMENT AND ITS CONTENTS ARE THE PROPERTY OF MINI-CIRCUITS. EXCEPT FOR USE EXPRESSLY GRANTED, IN WRITING, TO ITS VENDORS, VENDEE AND THE UNITED STATES GOVERNMENT, MINI-CIRCUITS RESERVES ALL PROPRIETARY DESIGN, USE, MANUFACTURING AND REPRODUCTION RIGHTS THERETO. THESE CONTENTS SHALL NOT BE USED, DUPLICATED OR DISCLOSED TO ANY OUTSIDE PARTY, IN WHOLE OR IN PART, WITHOUT WRITTEN PERMISSION OF MINI-CIRCUITS.

SIZE A	CODE IDENT 15542	DRAWING NO: 98-PL-253	REV: OR
FILE: 98PL253	SCALE: 8:1	SHEET: 1 OF 1	





All Mini-Circuits products are manufactured under exacting quality assurance and control standards, and are capable of meeting published specifications after being subjected to any or all of the following physical and environmental test.

Specification	Test/Inspection Condition	Reference/Spec
Operating Temperature	-40° to 85°C Ambient Environment	Individual Model Data Sheet
Storage Temperature	-55° to 100° C Ambient Environment	Individual Model Data Sheet
Thermal Shock	-55° to 100°C, 100 cycles	MIL-STD-202, Method 107, Condition A-3, except +100°C
Mechanical Shock	1.5Kg, 0.5 ms, 5 shock pulses, Y1 direction only	MIL-STD-883, Method 2002, Condition B, except Y1 direction only
Vibration (Variable Frequency)	50g peak	MIL-STD-883, Method 2007, Condition B
Autoclave	15 psig, 100% RH, 121°C, 96 hours	JESD22-A102, Condition C
HAST	130°C, 85% RH, 96 hours	JESD22-A110
Solderability	10X Magnification	J-STD-002, Para 4.2.5, Test S, 95% Coverage
Solder Reflow Heat	Sn-Pb Eutetic Process: 240°C peak Pb-Free Process: 260°C peak	J-STD-020, Table 4-1, 4-2 and 5-2; Figure 5-1
Moisture Sensitivity: Level 1	Bake at 125°C for 24 hours Soak at 85°C/85% RH for 168 hours, Reflow 3 cycles at 260°C peak	J-STD-020
Marking Resistance to Solvents	Isopropyl alcohol + mineral spirits at 25°C; terpene defluxer at 25°C; distilled water + proylene glycol monomethyl ether +	MIL-STD-202, Method 215



All Mini-Circuits products are manufactured under exacting quality assurance and control standards, and are capable of meeting published specifications after being subjected to any or all of the following physical and environmental test.

Specification	Test/Inspection Condition	Reference/Spec
---------------	---------------------------	----------------

monoethanolamine at 63°C to 70°C