



LTCC SURFACE MOUNT

Low Pass Filter

LFCN-3802+

50Ω DC to 38 GHz

THE BIG DEAL

- Low Insertion Loss, Typ. 1.8 dB
- Stopband Rejection, Typ. 34 dB
- Passband Return Loss, Typ. 10 dB
- Rugged Ceramic Construction
- 1206 Surface Mount Footprint

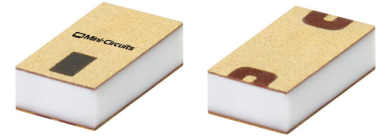

Generic photo used for illustration purposes only

FUNCTIONAL DIAGRAM

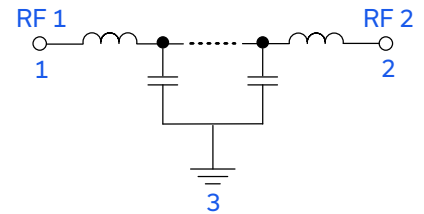

APPLICATIONS

- Communications
- Radar, EW, and ECM Defense Systems
- Test & Measurement Equipment

PRODUCT OVERVIEW

Mini-Circuits' LFCN-3802+ is a miniature low-temperature co-fired ceramic (LTCC) low pass filter with a DC to 38 GHz passband that supports a variety of applications. This model provides 1.8 dB typical insertion loss over a wide band, due to its rugged monolithic construction. Housed in a small 1206 ceramic form factor, the filter is ideal for dense signal chain PCB layouts, where it complements MMIC size and performance. The LTCC fabrication process assures minimal RF performance variation while delivering a product that is well-suited for environmental extremes of high humidity and temperature.

KEY FEATURES

Feature	Advantages
Ultra-Wide Stopband	Provides excellent stopband rejection to 67 GHz, suitable for wideband applications.
LTCC Construction	The use of LTCC technology allows for repeatable performance in a rugged ceramic package, well suited for tough environments such as high humidity and temperature extremes. See Mini-Circuits Environmental Rating ENV06T10 for more information.
Excellent Performance for Size	Offers best in class performance relative to larger-size alternative technologies. This mmWave multi-layer surface mount LTCC filter in a 1206 package allows for space to be saved in dense circuit board layouts, while also minimizing the effects of parasitics.



ELECTRICAL SPECIFICATIONS^{1,2,3} AT +25°C

Parameter	F#	Frequency (GHz)	Min.	Typ.	Max.	Units
Passband	Insertion Loss	DC - F1	—	1.8	2.5	dB
	Freq. Cut-Off ⁴	Fc	—	3.0	—	dB
	Return Loss	DC - F1	DC-38	—	10	dB
Stopband	Rejection	F2 - F3	21	31	—	dB
		F3 - F4	24	34	—	dB

1. Tested on Evaluation Board P/N TB-LFCN-3802C+ with the connector and feedline effects de-embedded using the 2XThru IEEE P370 method.
2. Bi-directional, RF1 and RF2 ports can be interchanged.
3. In applications where DC voltage and/or current is present at either the input or output ports, external DC blocking capacitors are required.
4. Cut-off frequency has typical variation of ±4%.

ABSOLUTE MAXIMUM RATINGS⁵

Parameter	Ratings
Operating Temperature	-55°C to +125°C
Storage Temperature	-55°C to +125°C
Input Power ⁶	1 W

5. Permanent damage may occur if any of these limits are exceeded.
6. Power rating applies only to signals within the passband. Power rating above +25°C operating temperature decreases linearly to 0.5 W at +125°C.

TYPICAL FREQUENCY RESPONSE AT +25°C

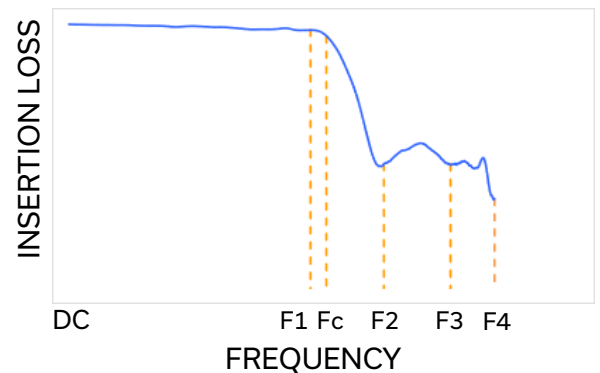



LTCC SURFACE MOUNT

Low Pass Filter

LFCN-3802+

Mini-Circuits

50Ω DC to 38 GHz

TYPICAL PERFORMANCE GRAPHS

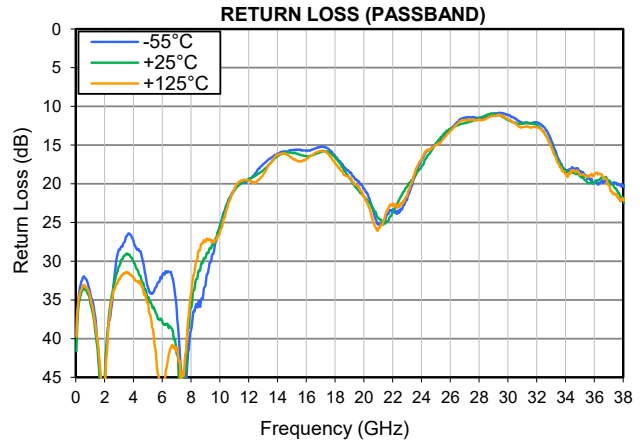
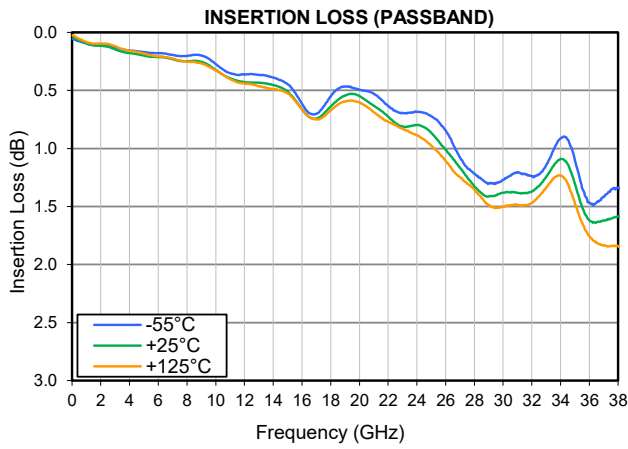
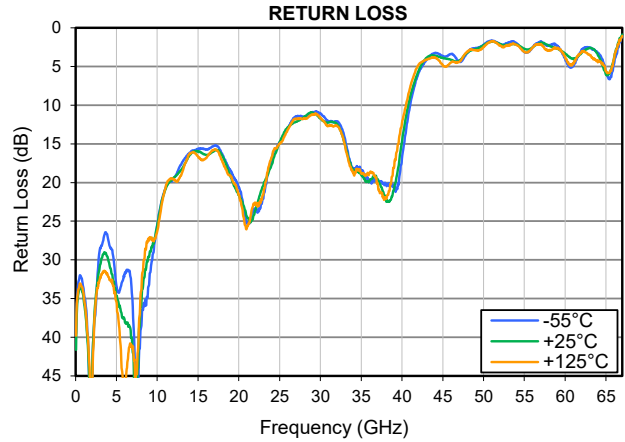
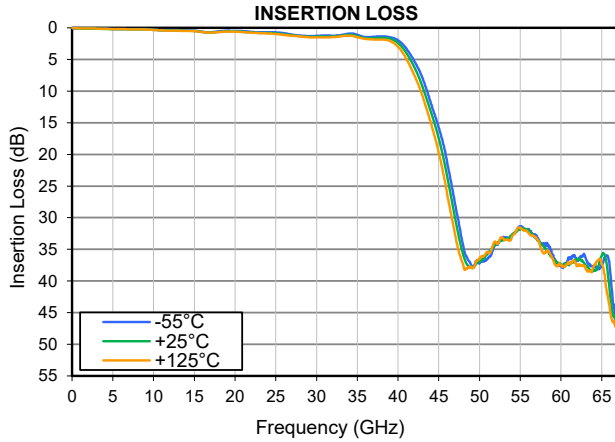



FUNCTIONAL DIAGRAM

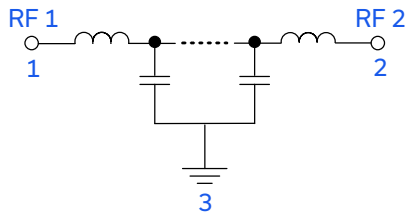
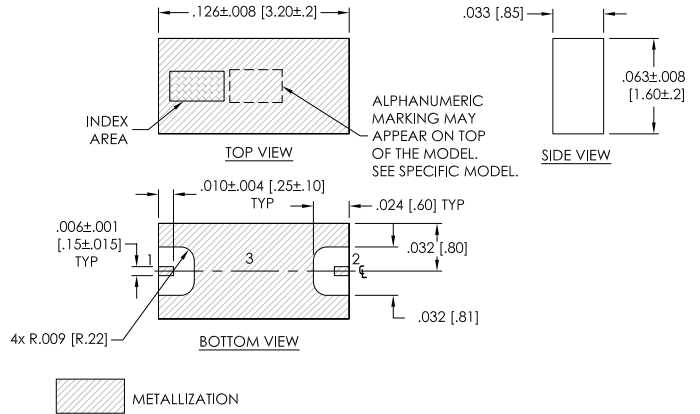

Figure 1. LFCN-3802+ Functional Diagram

PAD DESCRIPTION

Function	Pad Number	Description
RF1 ²	1	Connects to RF Input Port
RF2 ²	2	Connects to RF Output Port
GROUND	3	Connects to Ground on PCB, (See drawing PL-748)

CASE STYLE DRAWING



Weight: .017 grams
 Dimensions are in inches [mm]. Tolerances: 2 Pl.±.03; 3Pl.±.015

SUGGESTED PCB LAYOUT (PL-748)

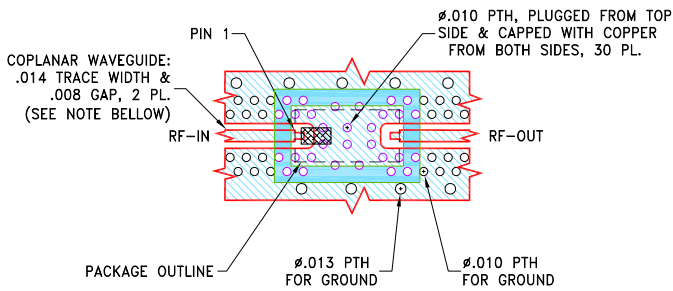

NOTES:

- TRACE WIDTH & GAP PARAMETERS ARE SHOWN FOR MEGTRON-7 R5785(N); DIELECTRIC THICKNESS: .0079±.001; COPPER: HVLP/HVLP. FOR OTHER MATERIALS TRACE WIDTH & GAP MAY NEED TO BE MODIFIED.
- BOTTOM SIDE OF THE PCB IS CONTINUOUS GROUND PLANE.

- DENOTES PCB COPPER LAYOUT WITH SMOBC (SOLDER MASK OVER BARE COPPER).
- DENOTES COPPER LAND PATTERN FREE OF SOLDER MASK.

Figure 2. Suggested PCB Layout PL-748

PRODUCT MARKING*: B8

*Marking may contain other features or characters for internal lot control.



LTCC SURFACE MOUNT

Low Pass Filter

LFCN-3802+

Mini-Circuits

50Ω DC to 38 GHz

ADDITIONAL INFORMATION IS AVAILABLE ON OUR DASHBOARD

[CLICK HERE](#)

Performance Data & Graphs	Data Graphs S-Parameter (S2P Files) Data Set (.zip file) De-embedded to device pads
Case Style	FV1206-12 Lead Finish: Gold over Nickel Plating
RoHS Status	Compliant
Tape and Reel	F75
Suggested Layout for PCB Design	PL-748
Evaluation Board	TB-LFCN-3802C+ Gerber File
Environmental Rating	ENV06T10

NOTES

- A. Performance and quality attributes and conditions not expressly stated in this specification document are intended to be excluded and do not form a part of this specification document.
- B. Electrical specifications and performance data contained in this specification document are based on Mini-Circuit's applicable established test performance criteria and measurement instructions.
- C. The parts covered by this specification document are subject to Mini-Circuits standard limited warranty and terms and conditions (collectively, "Standard Terms"); Purchasers of this part are entitled to the rights and benefits contained therein. For a full statement of the standard terms and the exclusive rights and remedies thereunder, please visit Mini-Circuits' website at www.minicircuits.com/terms/viewterm.html



LTCC Lowpass Filter

Typical Performance Data

LFCN-3802+

FREQUENCY (GHz)	INSERTION LOSS (dB)			RETURN LOSS (dB)		
	@-55°C	@+25°C	@+125°C	@-55°C	@+25°C	@+125°C
0.1	0.06	0.04	0.03	37.13	38.45	37.04
1.0	0.10	0.09	0.08	34.09	35.27	34.65
2.0	0.11	0.12	0.10	48.47	45.56	47.21
3.0	0.13	0.15	0.12	28.47	30.62	32.28
4.0	0.16	0.18	0.16	27.33	30.01	32.19
5.0	0.17	0.20	0.18	33.33	34.76	35.39
6.0	0.18	0.21	0.21	31.86	37.71	46.12
7.0	0.19	0.23	0.22	36.08	41.94	41.16
8.0	0.20	0.25	0.25	38.91	36.05	34.19
9.0	0.20	0.25	0.27	33.20	29.62	27.51
10.0	0.27	0.32	0.33	25.54	25.54	26.37
11.0	0.35	0.40	0.40	20.78	20.89	20.73
12.0	0.36	0.43	0.44	19.46	19.39	19.58
13.0	0.37	0.43	0.46	17.48	18.28	18.82
14.0	0.39	0.45	0.49	16.12	16.42	16.22
15.0	0.45	0.51	0.52	15.62	15.99	16.64
16.0	0.61	0.66	0.66	15.71	16.43	16.83
17.0	0.70	0.74	0.75	15.23	15.89	15.77
18.0	0.55	0.64	0.67	16.39	16.60	17.33
19.0	0.47	0.55	0.60	18.51	19.28	19.20
20.0	0.49	0.55	0.61	20.57	21.64	21.54
21.0	0.53	0.63	0.69	25.14	24.39	25.78
22.0	0.64	0.73	0.77	23.31	23.65	22.58
23.0	0.69	0.81	0.83	22.07	20.40	21.61
24.0	0.68	0.80	0.89	17.03	17.77	16.79
25.0	0.72	0.87	0.98	14.82	14.79	15.01
26.0	0.84	1.01	1.11	12.97	12.86	13.17
27.0	1.08	1.17	1.25	11.43	12.13	11.72
28.0	1.22	1.33	1.36	11.50	11.50	11.75
29.0	1.30	1.41	1.49	10.95	10.99	11.20
30.0	1.27	1.38	1.50	11.13	11.72	11.64
31.0	1.21	1.38	1.48	12.09	12.24	12.67
32.0	1.24	1.37	1.47	12.07	12.39	12.63
33.0	1.14	1.24	1.34	14.32	15.07	15.16
34.0	0.91	1.09	1.23	18.28	18.30	18.74
35.0	1.11	1.31	1.48	18.49	19.01	18.85
36.0	1.46	1.62	1.75	19.89	19.85	18.77
37.0	1.42	1.62	1.84	19.76	19.58	20.07
38.0	1.34	1.59	1.84	20.27	21.98	22.05
39.0	1.48	1.70	2.07	20.73	20.96	18.13
40.0	1.97	2.40	2.99	16.89	14.74	12.31
41.0	3.24	3.92	4.85	9.95	8.92	7.66
41.5	4.19	4.99	6.11	7.67	7.12	6.04
42.0	5.27	6.21	7.50	5.97	5.64	4.86
43.0	7.91	9.29	10.76	4.15	3.88	4.13
44.0	11.75	13.15	14.93	3.29	3.60	3.89
45.0	15.75	17.47	19.73	3.65	3.89	4.83
46.0	21.04	23.27	26.00	3.38	4.13	4.50
47.0	27.79	30.05	32.62	4.38	4.28	4.42
48.0	34.49	35.90	37.53	3.19	3.18	3.05
49.0	37.56	37.78	37.83	2.61	2.77	2.90
50.0	37.22	36.89	36.49	2.20	2.26	2.49
51.0	36.52	35.70	35.45	1.68	1.78	1.74
52.0	34.13	34.21	33.88	2.07	2.08	2.21
53.0	33.14	33.57	33.43	1.95	2.20	2.30
54.0	32.84	32.70	32.90	1.95	2.13	2.18
55.0	31.46	31.88	31.64	3.10	2.69	3.09
56.0	31.92	32.09	32.39	2.55	2.53	2.55
57.0	33.13	33.36	33.27	1.78	1.92	2.13
58.0	34.43	34.68	35.55	2.26	2.31	2.93
59.0	36.14	36.31	36.55	2.32	2.70	2.67
60.0	37.38	37.45	37.52	4.00	3.30	3.73
61.0	36.54	37.52	37.17	4.96	4.04	4.68
62.0	36.80	36.60	37.59	2.82	3.28	3.07
63.0	36.28	37.46	38.01	2.52	2.59	3.48
64.0	37.72	38.32	37.78	3.30	3.49	4.46
65.0	37.53	35.98	37.25	5.68	6.05	5.61
67.0	48.11	46.49	47.46	0.99	0.87	1.05



P.O. Box 350166, Brooklyn, New York 11235-0003 (718) 934-4500 • Fax (718) 332-4661 For detailed performance specs & shopping online see Mini-Circuits web site

The Design Engineers Search Engine Provides ACTUAL Data Instantly From MINI-CIRCUITS At: www.minicircuits.com

IF/RF MICROWAVE COMPONENTS

Typical Performance Data

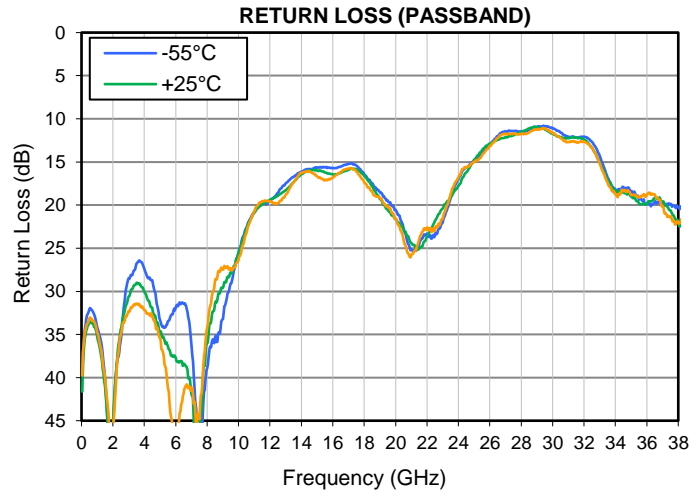
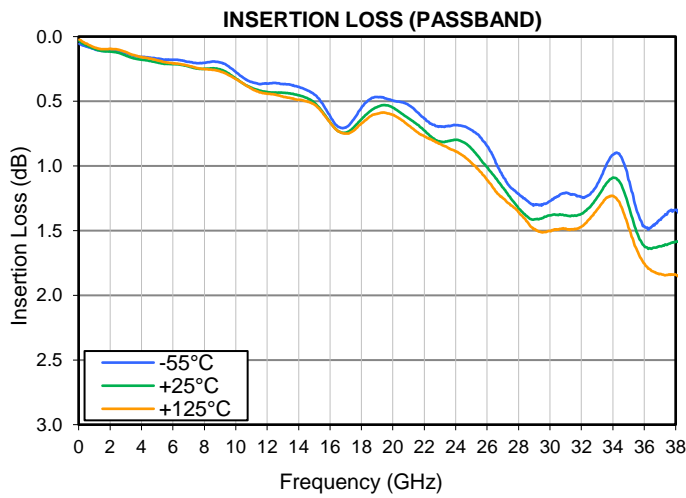
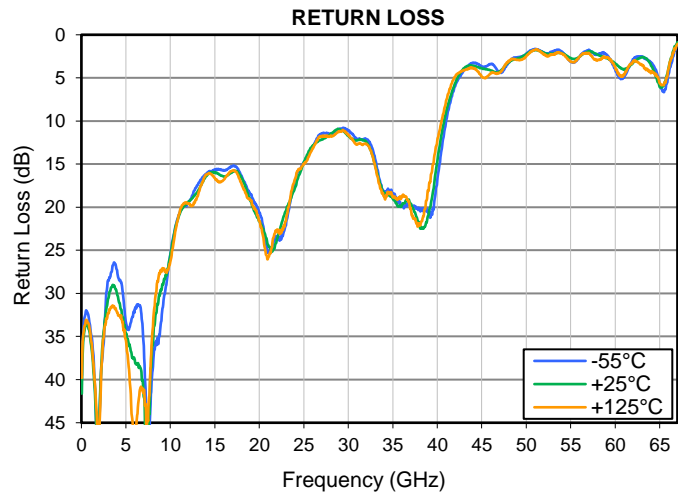
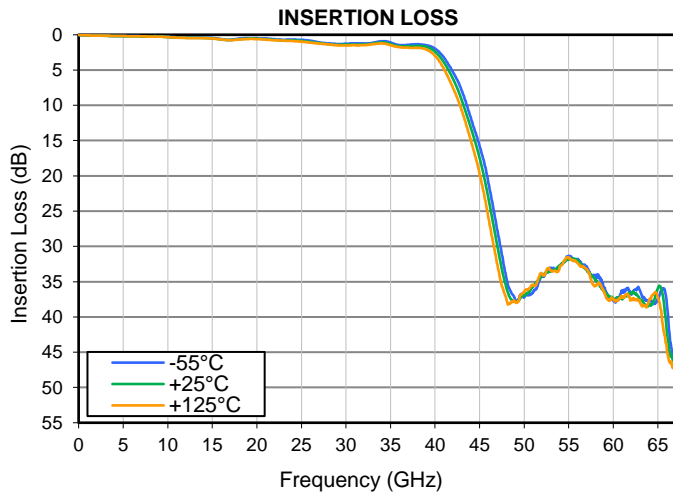

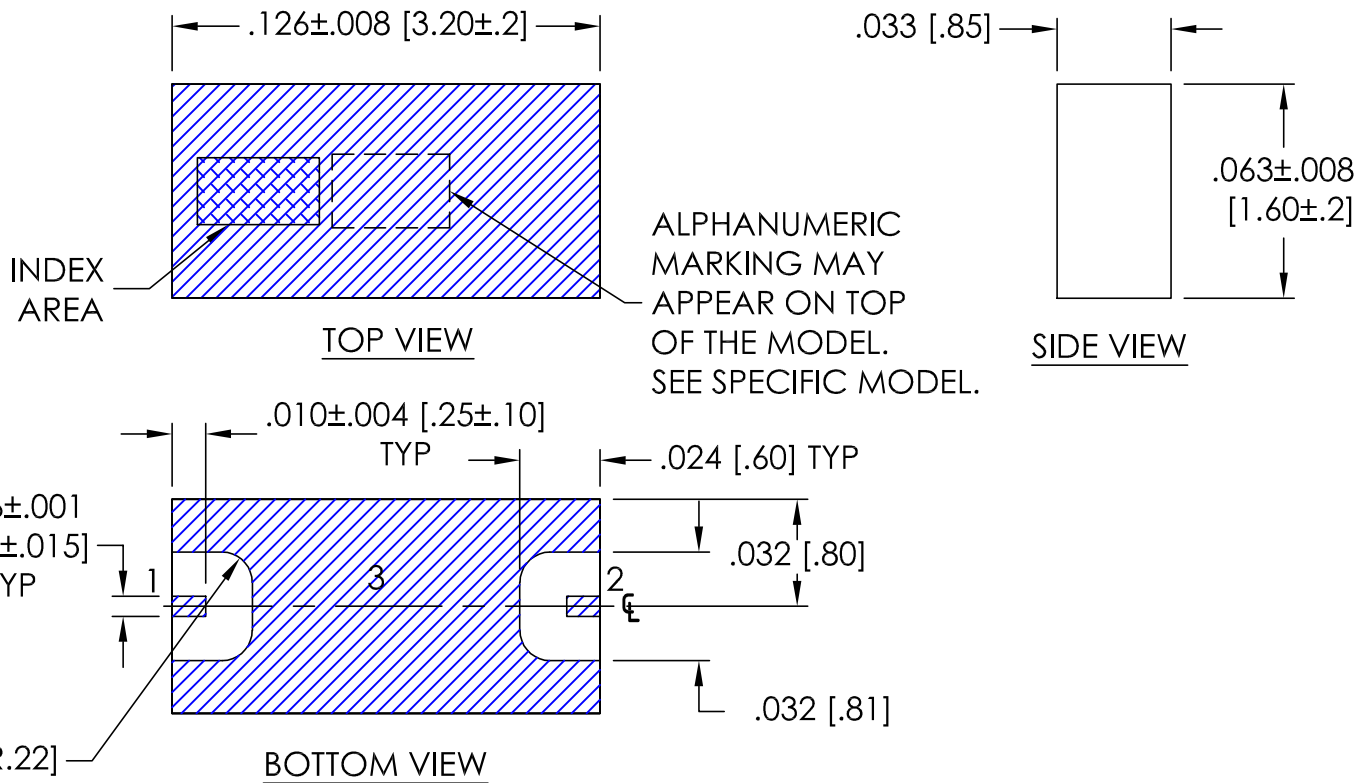

Weight: .017 grams.

Dimensions are in inches (mm). Tolerances: 2 Pl. ± .01; 3 Pl. ± .005

Notes:

1. Case material: Ceramic.
2. Termination Finish: **as shown below or indicated on Data Sheet.**
For RoHS Case Styles: Gold plate over Nickel plate All models, (+) suffix.

Mini-Circuits®
ISO 9001 ISO 14001 CERTIFIED

ALL NEW
minicircuits.com

P.O. Box 350166, Brooklyn, New York 11235-0003 (718) 934-4500 Fax (718) 332-4661 For detailed performance specs & shopping online see Mini-Circuits web site



The Design Engineers Search Engine Provides ACTUAL Data Instantly From MINI-CIRCUITS At: www.minicircuits.com

RF/IF MICROWAVE COMPONENTS

THIRD ANGLE PROJECTION

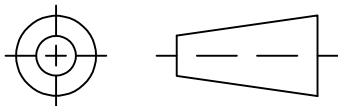

REVISIONS

REV	ECN No.	DESCRIPTION	DATE	DR	AUTH
OR	ECO-016075	NEW RELEASE	12/09/22	ITG	IL

SUGGESTED MOUNTING CONFIGURATION
FV1206-12 CASE STYLE

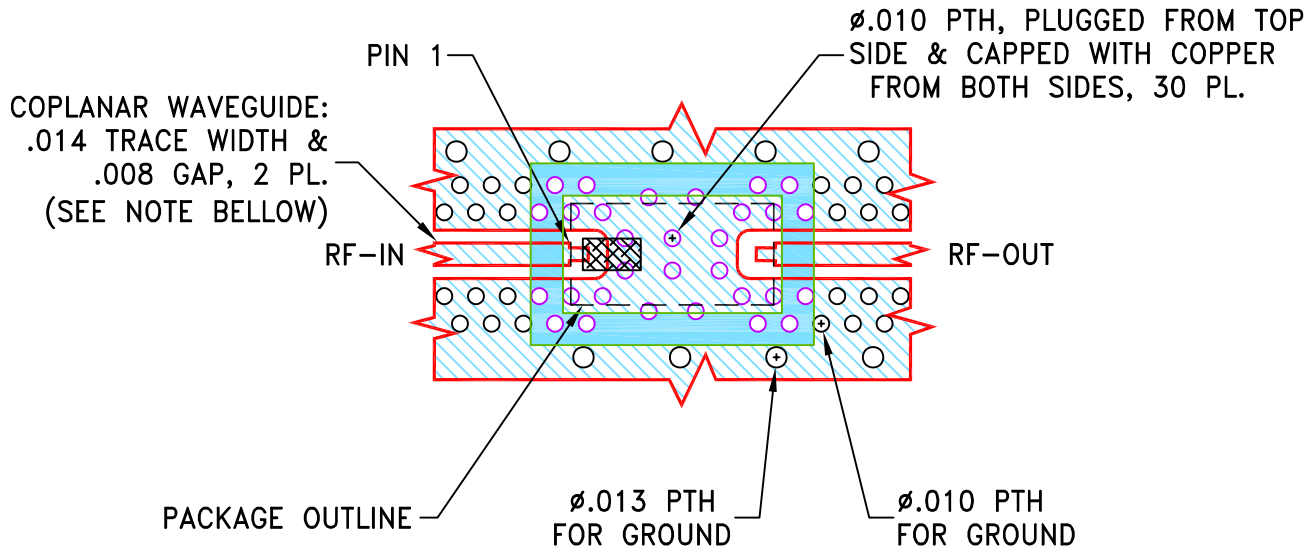

NOTES:

1. TRACE WIDTH & GAP PARAMETERS ARE SHOWN FOR MEGTRON-7 R5785(N); DIELECTRIC THICKNESS: .0079±.001; COPPER: HVLP/HVLP. FOR OTHER MATERIALS TRACE WIDTH & GAP MAY NEED TO BE MODIFIED.
2. BOTTOM SIDE OF THE PCB IS CONTINUOUS GROUND PLANE.



DENOTES PCB COPPER LAYOUT WITH SMOBC (SOLDER MASK OVER BARE COPPER).

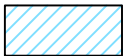

DENOTES COPPER LAND PATTERN FREE OF SOLDER MASK.

UNLESS OTHERWISE SPECIFIED	INITIALS		DATE
DIMENSIONS ARE IN INCHES	DRAWN	ITG	12/09/22
TOLERANCES ON:	CHECKED	GF	12/09/22
2 PL DECIMALS ±	APPROVED	IL	12/09/22
3 PL DECIMALS ± .005			
ANGLES ±			
FRACTIONS ±			



Mini-Circuits®

13 Neptune Avenue
Brooklyn NY 11235

PL, FV1206-12, TB-HFCN-2502+

Mini-Circuits®
THIS DOCUMENT AND ITS CONTENTS ARE THE PROPERTY OF MINI-CIRCUITS. EXCEPT FOR USE EXPRESSLY GRANTED, IN WRITING, TO ITS VENDORS, VENDEE AND THE UNITED STATES GOVERNMENT, MINI-CIRCUITS RESERVES ALL PROPRIETARY DESIGN, USE, MANUFACTURING AND REPRODUCTION RIGHTS THERETO. THESE CONTENTS SHALL NOT BE USED, DUPLICATED OR DISCLOSED TO ANY OUTSIDE PARTY, IN WHOLE OR IN PART, WITHOUT WRITTEN PERMISSION OF MINI-CIRCUITS.

SIZE	CODE IDENT	DRAWING NO:	REV:
A	15542	98-PL-748	OR
FILE:	98PL748	SCALE: 8:1	SHEET: 1 OF 1

Evaluation Board and Circuit

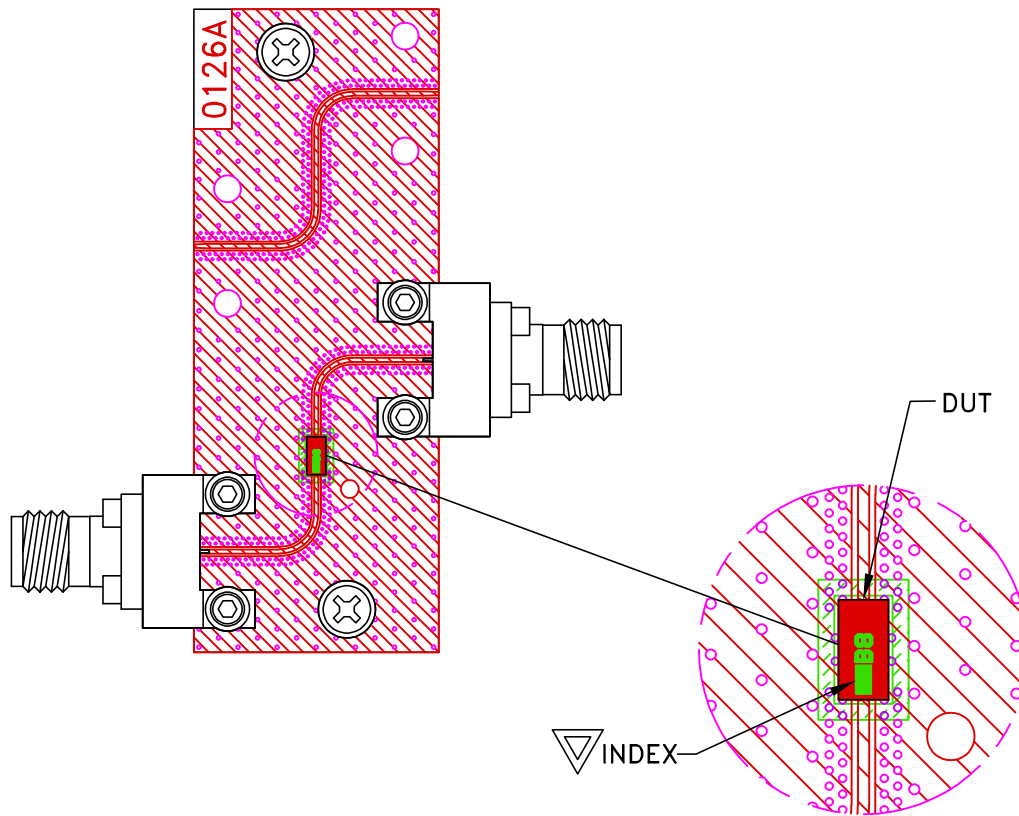

TB-LFCN-3802C+

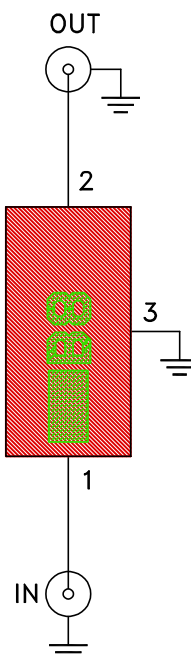

Schematic Diagram

1. 50 Ohm 2.4 End Launch Female connectors.
2. PCB Material: Megtron 7(N) or equivalent,
Dielectric Constant=3.4, Thickness=.0079 inch.

 **Mini-Circuits®**

All Mini-Circuits products are manufactured under exacting quality assurance and control standards, and are capable of meeting published specifications after being subjected to any or all of the following physical and environmental test.

Specification	Test/Inspection Condition	Reference/Spec
Operating Temperature	-55° to 125° C Ambient Environment	Individual Model Data Sheet
Storage Temperature	-55° to 125° C Ambient Environment	Individual Model Data Sheet
Humidity	90 to 95% RH, 240 hours, 50°C	MIL-STD-202, Method 103, Condition A, Except 50°C and end-point electrical test done within 12 hours
Solder Reflow Heat	Sn-Pb Eutectic Process 225°C peak Pb-Free Process 245° - 250°C peak	J-STD-020C, Table 4-1, 4-2 and 5-2, Figure 5-1
Solderability	10X Magnification	J-STD-002, Test B,B1, 95% Coverage
Thermal Shock	-55° to +125°C, 15 min dwell,250 cycles	MIL-STD-202, Method 107
Bend Test	1mm, deflection for 5 seconds Span of bending: 2.75"	--
High Temp Storage	125°C to 1000 Hrs	---