



CERAMIC

Low Pass Filter

LFCN-3400D+

Mini-Circuits

50Ω DC to 3400 MHz

FEATURES

- Excellent power handling, 8W
- Small size
- 5 sections
- Temperature stable
- Hermetically sealed
- LTCC construction
- Protected by U.S. Patent 6,943,646

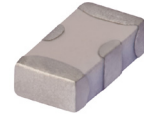

Generic photo used for illustration purposes only

CASE STYLE: FV1206

+RoHS Compliant

The +Suffix identifies RoHS Compliance. See our web site for RoHS Compliance methodologies and qualifications

APPLICATIONS

- Harmonic rejection
- Transmitters/receivers
- Point to point

ELECTRICAL SPECIFICATIONS^{1,2} AT 25°C

Parameter	F#	Frequency (MHz)	Min.	Typ.	Max.	Units	
Passband	Insertion Loss	DC-F1	DC-3400	—	—	1.5	dB
	Freq. Cut-Off	F2	3950	—	3.0	—	dB
	VSWR	DC-F1	DC-3400	—	1.2	—	:1
Stop Band	Rejection Loss	F3-F4	4300-4600	20	—	—	dB
		F4-F5	4600-7800	—	25	—	
	VSWR	F5-F6	7800-8300	—	20	—	:1
		F3-F6	4300-8300	—	17	—	

1. DC Resistance to ground is 100 Mohms min.

2. Measured on Mini-Circuits Characterization Test Board TB-270.

MAXIMUM RATINGS

Parameter	Ratings
Operating temperature	-55°C to 100°C
Storage temperature	-55°C to 100°C
RF Power Input ³	8 W max. at 25°C
Max. DC Voltage at pins 1&3	25 VDC
DC Current Input to Output	0.5A max. at 25°C

3. Derate linearly to 3W at 100°C ambient. Permanent damage may occur if any of these limits are exceeded.

TYPICAL FREQUENCY RESPONSE

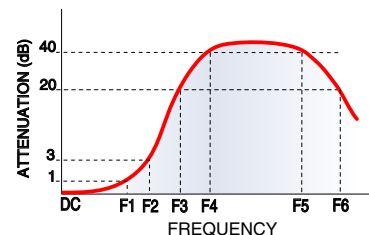

FUNCTIONAL SCHEMATIC

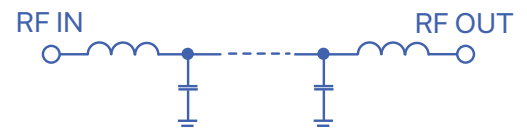

REV. B
ECO-011761
LFCN-3400D+
AD/CP/AM
220128



CERAMIC

Low Pass Filter

LFCN-3400D+

PIN CONNECTIONS

RF IN	1
RF OUT	3
GROUND	2,4

PRODUCT MARKING: N/A

DEMO BOARD MCL P/N: TB-270
SUGGESTED PCB LAYOUT (PL-137)

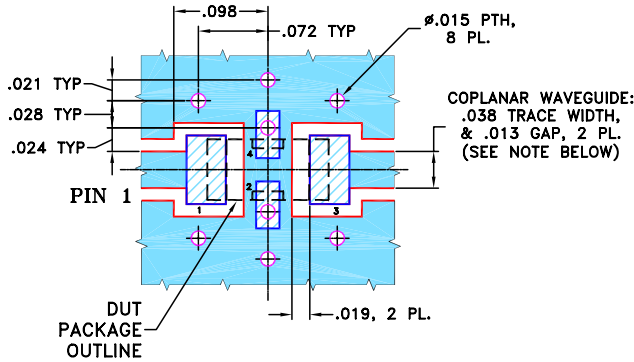

- NOTES:**
1. COPLANAR WAVEGUIDE PARAMETERS ARE SHOWN FOR ROGERS RO4350B WITH THICKNESS .020" ± .0015".
COPPER: 1/2 OZ. EACH SIDE.
FOR OTHER MATERIALS TRACE WIDTH & GAP MAY NEED TO BE MODIFIED.
 2. BOTTOM SIDE OF THE PCB IS CONTINUOUS GROUND PLANE.

- DENOTES PCB COPPER LAYOUT WITH SMOBC (SOLDER MASK OVER BARE COPPER)
- DENOTES COPPER LAND PATTERN FREE OF SOLDER MASK

OUTLINE DRAWING



PCB Land Pattern

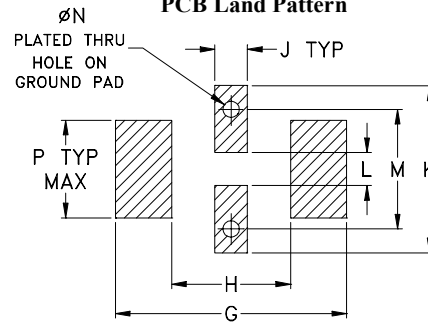

Suggested Layout,
Tolerance to be within ±.002

OUTLINE DIMENSIONS (Inches mm)

A	B	C	D	E	F	G
.126	.063	.037	.020	.032	.009	.169
3.20	1.60	0.94	0.51	0.81	0.23	4.29

H	J	K	L	M	N	P	wt
.087	.024	.122	.024	.087	.012	.071	grams
2.21	0.61	3.10	0.61	2.21	0.30	1.80	.020

TAPE & REEL INFORMATION: F71



CERAMIC

Low Pass Filter

LFCN-3400D+

TYPICAL PERFORMANCE DATA AT 25°C

Frequency (MHz)	Insertion Loss (dB)	VSWR (:1)
40	0.01	1.01
100	0.03	1.01
500	0.08	1.04
1000	0.15	1.10
2000	0.31	1.32
3000	0.73	1.76
3400	1.03	1.99
3800	1.73	1.98
3950	3.04	2.21
4050	6.01	3.38
4150	12.50	6.26
4300	29.75	11.53
4600	25.02	19.32
5050	23.78	26.33
6500	24.27	28.96
7800	25.25	19.32
8300	21.39	18.11

LFCN-3400D+
INSERTION LOSS

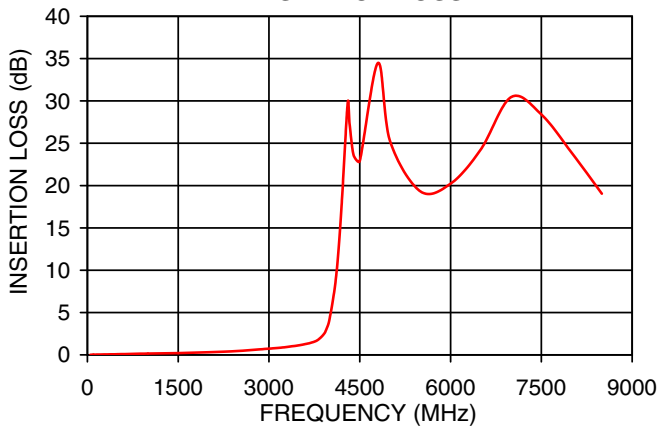

LFCN-3400D+
VSWR

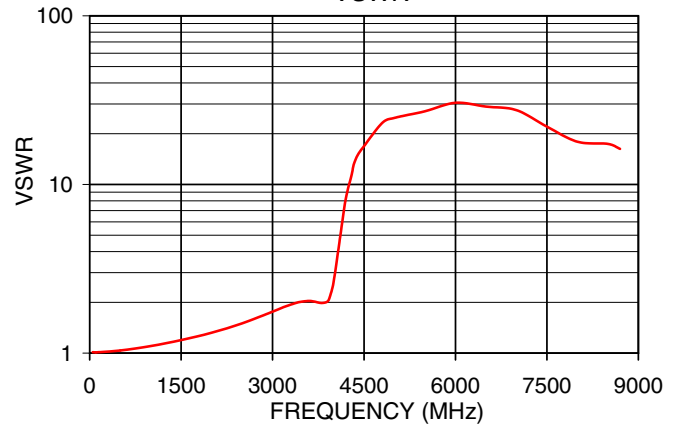

NOTES

- A. Performance and quality attributes and conditions not expressly stated in this specification document are intended to be excluded and do not form a part of this specification document.
- B. Electrical specifications and performance data contained in this specification document are based on Mini-Circuit's applicable established test performance criteria and measurement instructions.
- C. The parts covered by this specification document are subject to Mini-Circuits standard limited warranty and terms and conditions (collectively, "Standard Terms"); Purchasers of this part are entitled to the rights and benefits contained therein. For a full statement of the standard. Terms and the exclusive rights and remedies thereunder, please visit Mini-Circuits' website at www.minicircuits.com/MCLStore/terms.jsp



Ceramic Low Pass Filter

LFCN-3400D+

Typical Performance Data

FREQ. (MHz)	INSERTION LOSS (dB)			INPUT RETURN LOSS (dB)			OUTPUT RETURN LOSS (dB)		
	@ -55° C	@ +25° C	@ +100° C	@ -55° C	@ +25° C	@ +100° C	@ -55° C	@ +25° C	@ +100° C
40	0.03	0.03	0.04	53.18	42.74	37.82	48.23	40.56	36.60
100	0.00	0.02	0.03	46.05	47.47	37.74	44.61	45.67	37.82
500	0.04	0.08	0.10	36.62	33.82	28.67	35.66	33.17	28.32
1000	0.09	0.14	0.18	26.11	26.27	25.24	25.89	26.08	25.01
1500	0.14	0.22	0.25	22.05	21.81	22.73	21.89	21.68	22.66
2000	0.20	0.30	0.33	18.36	18.07	18.69	18.33	18.04	18.59
2500	0.32	0.42	0.49	15.10	15.14	15.13	15.01	15.12	15.05
3000	0.48	0.62	0.72	12.68	12.59	12.46	12.75	12.66	12.53
3200	0.58	0.73	0.84	11.68	11.64	11.59	11.72	11.73	11.73
3400	0.74	0.90	1.07	10.77	10.86	10.71	10.73	10.86	10.98
3500	0.84	1.02	1.22	10.37	10.50	10.31	10.30	10.43	10.60
3600	0.95	1.13	1.35	10.03	10.22	10.18	9.87	10.02	10.16
3675	1.07	1.27	1.47	9.83	10.10	10.24	9.50	9.66	9.72
3800	1.37	1.62	1.84	9.61	9.96	10.24	8.71	8.83	8.76
3900	1.86	2.22	2.56	9.27	9.53	9.80	7.57	7.56	7.34
3950	2.33	2.80	3.26	8.67	8.80	8.93	6.64	6.54	6.24
4000	3.08	3.73	4.39	7.58	7.58	7.49	5.48	5.34	4.98
4110	6.90	8.21	9.59	4.38	4.31	4.18	2.78	2.77	2.58
4200	13.61	15.76	17.94	2.45	2.54	2.60	1.51	1.69	1.66
4300	27.96	29.03	28.35	1.48	1.69	1.83	1.05	1.28	1.33
4330	29.85	27.78	26.41	1.38	1.58	1.74	1.07	1.29	1.35
4400	24.26	23.67	23.32	1.14	1.36	1.52	0.99	1.20	1.28
4600	24.41	25.37	25.99	0.70	0.90	1.07	0.80	1.03	1.11
4800	35.82	34.96	32.67	0.60	0.77	0.95	0.70	0.98	1.04
5000	24.99	24.24	23.53	0.47	0.65	0.80	0.66	0.92	1.04
5500	18.69	18.86	18.96	0.40	0.55	0.64	0.55	0.86	0.92
6000	19.58	20.10	20.25	0.36	0.50	0.58	0.55	0.78	0.98
6500	22.92	23.45	23.66	0.39	0.54	0.66	0.65	0.56	0.62
7000	28.92	29.04	28.02	0.42	0.62	0.79	0.61	0.66	0.83
7400	30.50	30.55	30.04	0.46	0.68	0.95	0.59	0.68	0.74
7800	27.13	26.35	27.15	0.54	0.79	1.04	0.49	0.68	0.74
8000	24.21	23.76	24.90	0.61	0.88	1.12	0.56	0.72	0.75
8300	21.21	20.92	20.91	0.72	0.96	1.23	0.56	0.75	0.81
9000	10.32	9.99	9.52	1.56	1.92	2.31	1.34	1.84	2.40
9250	4.48	4.44	4.58	5.65	7.15	8.24	6.34	8.90	11.72
9500	5.07	6.40	7.40	4.86	3.96	3.57	4.53	3.71	3.42
10000	12.50	13.35	14.33	1.26	1.42	1.56	0.89	1.14	1.29
11000	16.14	15.82	16.10	0.97	1.27	1.40	0.85	1.16	1.38
12000	11.85	12.06	12.17	1.18	1.46	1.76	1.21	1.32	1.55
14000	7.38	7.30	7.30	2.93	3.63	4.59	1.88	2.30	2.72
15000	12.91	14.57	14.97	2.98	3.43	3.82	1.67	1.96	2.23
16000	17.41	17.72	17.12	3.22	3.21	3.14	1.43	2.21	2.71
18000	15.11	15.28	16.77	3.5	3.920	4.0	2.26	2.49	2.37
20000	8.10	8.02	7.90	2.0	2.570	3.1	3.63	4.63	5.71



Typical Performance Curves

INSERTION LOSS vs. TEMPERATURE

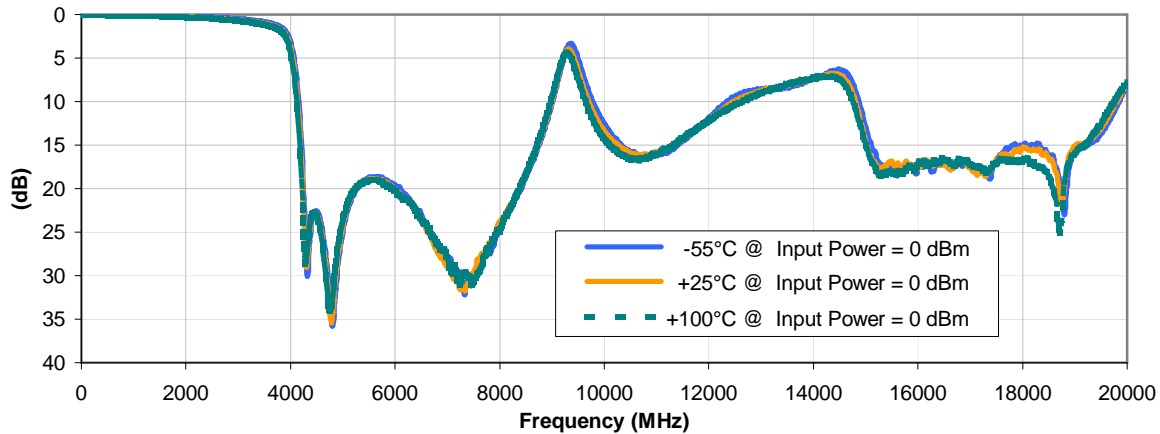

INPUT RETURN LOSS vs. TEMPERATURE

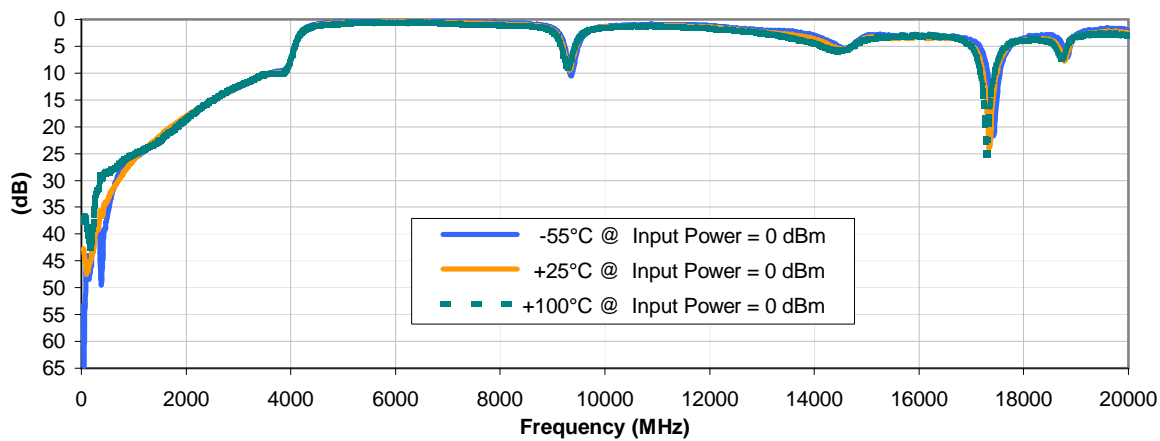

OUTPUT RETURN LOSS vs. TEMPERATURE

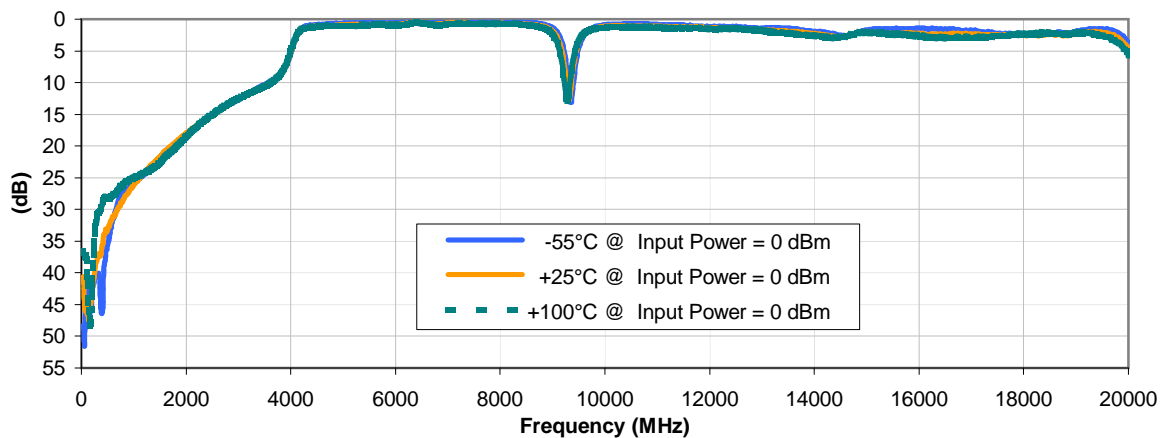

Outline Dimensions

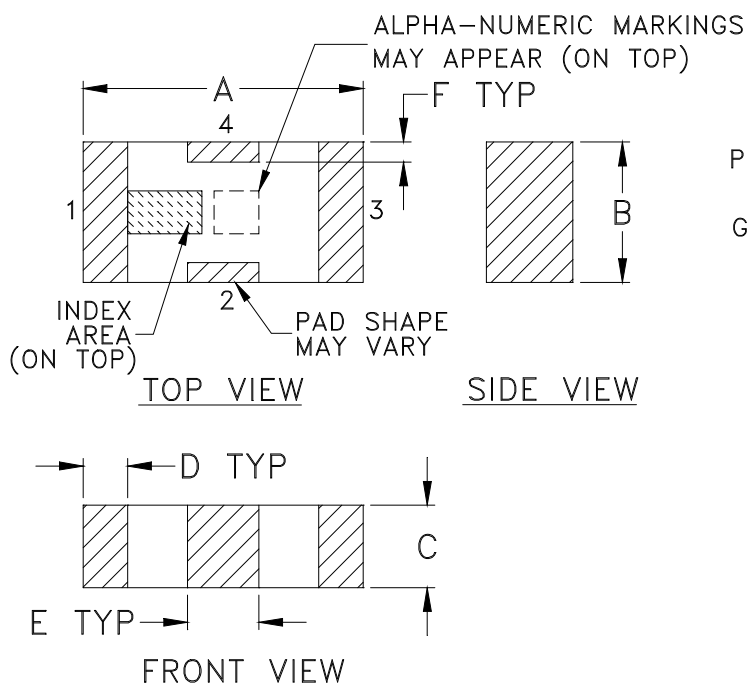

PCB Land Pattern

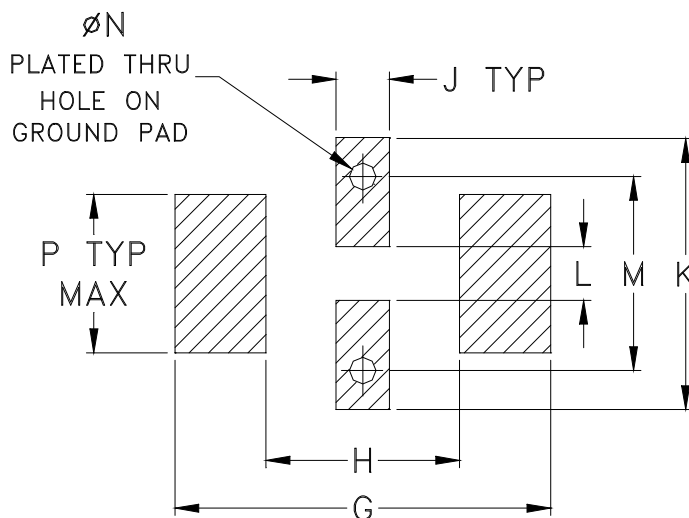

Suggested Layout,
Tolerance to be within $\pm .002$

CASE #	A	B	C	D	E	F	G	H	J	K	L	M	N	P	WT. GRAM
FV1206	.126 (3.20)	.063 (1.60)	.037 (0.94)	.020 (0.51)	.032 (0.81)	.009 (0.23)	.169 (4.29)	.087 (2.21)	.024 (0.61)	.122 (3.10)	.024 (0.61)	.087 (2.21)	.012 (0.30)	.071 (1.80)	.020

Dimensions are in inches (mm). Tolerances: 2 Pl. $\pm .01$; 3 Pl. $\pm .005$

Notes:

- Open style, ceramic base.
- Termination finish: **as shown below or indicated on Data Sheet.**
 For RoHS Case Styles: Tin plate over Nickel plate. All models, (+) suffix.
 For RoHS-5 Case Styles: Tin-Lead plate. All models, no (+) suffix.

Tape & Reel Packaging TR-F71

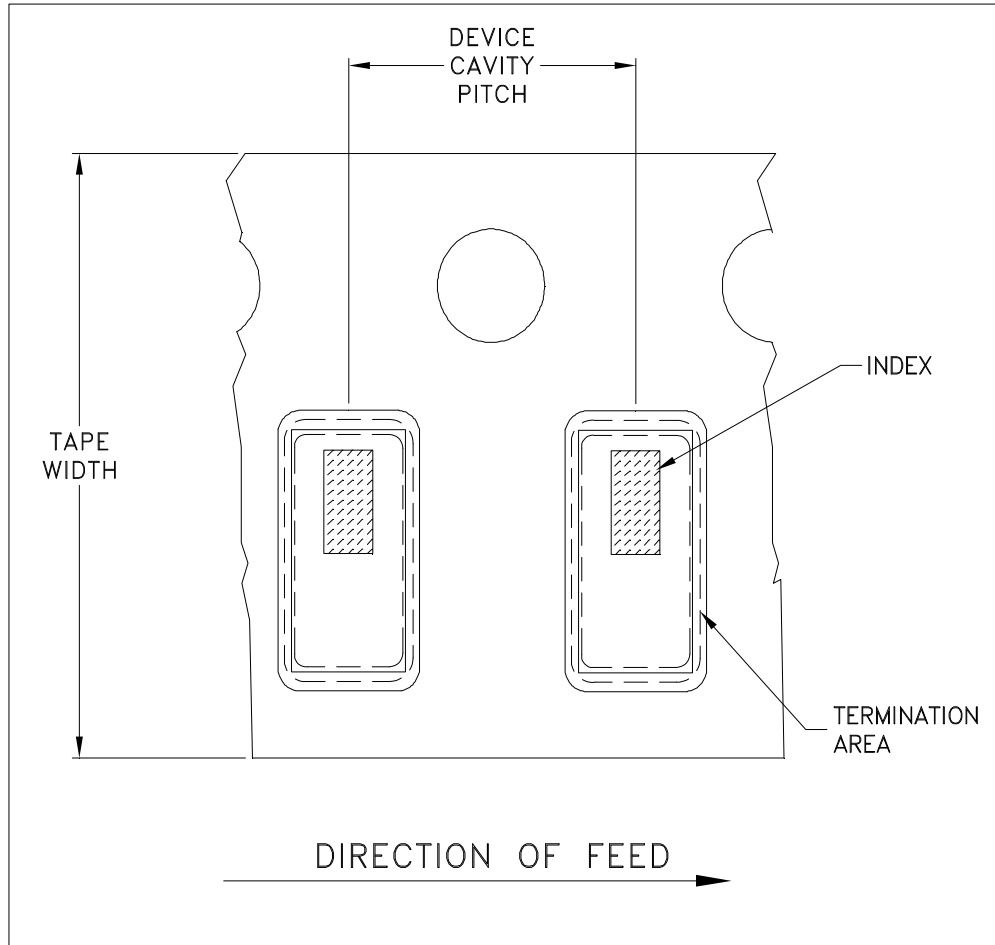

ILLUSTRATION 1

Tape Width, mm	Device Cavity Pitch, mm	Reel Size, inches	Devices per Reel	
8	4	7	Small quantity standards (see note)	20
				50
				100
				200
				500
				1000
			Standard	3000

Note: Please Consult individual model data sheet to determine device per reel availability.

Mini-Circuits carrier tape materials provide protection from ESD (Electro-Static Discharge) during handling and transportation. Tapes are static dissipative and comply with industry standards EIA-481/EIA-541.

Go to: www.minicircuits.com/pages/pdfs/tape.pdf



P.O. Box 350166, Brooklyn, New York 11235-0003 (718) 934-4500 Fax (718) 332-4661 For detailed performance specs & shopping online see Mini-Circuits web site



The Design Engineers Search Engine Provides ACTUAL Data Instantly From MINI-CIRCUITS At: www.minicircuits.com

RF/IF MICROWAVE COMPONENTS

THIRD ANGLE PROJECTION



REVISIONS

REV	ECN No.	DESCRIPTION	DATE	DR	AUTH
OR	M88634	NEW RELEASE	08/28/03	GF	ABD
A	M102713	ADDED "...WITH SMOBC"	01/17/06	MMG	IL

SUGGESTED MOUNTING CONFIGURATION
FOR FV1206 CASE STYLE, "nx" PIN CONNECTION

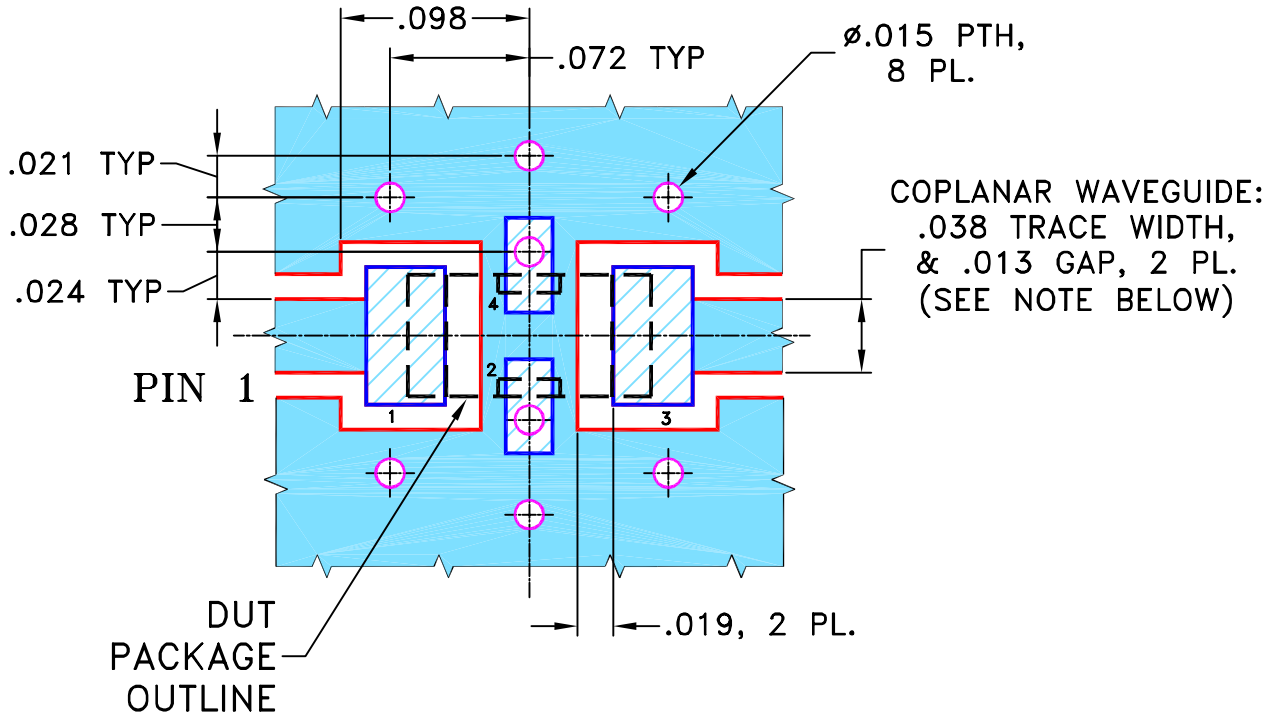

- NOTES:**
1. COPLANAR WAVEGUIDE PARAMETERS ARE SHOWN FOR ROGERS R04350B WITH THICKNESS .020" ± .0015".
 COPPER: 1/2 OZ. EACH SIDE.
 FOR OTHER MATERIALS TRACE WIDTH & GAP MAY NEED TO BE MODIFIED.

2. BOTTOM SIDE OF THE PCB IS CONTINUOUS GROUND PLANE.



DENOTES PCB COPPER LAYOUT WITH SMOBC
 (SOLDER MASK OVER BARE COPPER)

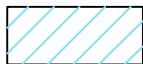

DENOTES COPPER LAND PATTERN FREE OF SOLDER MASK

UNLESS OTHERWISE SPECIFIED

INITIALS

DATE

DIMENSIONS ARE IN INCHES

DRAWN

GF

08/27/03

TOLERANCES ON:

CHECKED

AV

08/28/03

2 PL DECIMALS ±

APPROVED

ABD

08/28/03

3 PL DECIMALS ± .005

ANGLES ±

FRACTIONS ±

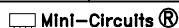

Mini-Circuits®

13 Neptune Avenue
 Brooklyn NY 11235

PL, nx, FV1206, LFCN/HFCN, TB-270

THIS DOCUMENT AND ITS CONTENTS ARE THE PROPERTY OF MINI-CIRCUITS. EXCEPT FOR USE EXPRESSLY GRANTED, IN WRITING, TO ITS VENDORS, VENDEE AND THE UNITED STATES GOVERNMENT, MINI-CIRCUITS RESERVES ALL PROPRIETARY DESIGN, USE, MANUFACTURING AND REPRODUCTION RIGHTS THERETO. THESE CONTENTS SHALL NOT BE USED, DUPLICATED OR DISCLOSED TO ANY OUTSIDE PARTY, IN WHOLE OR IN PART, WITHOUT WRITTEN PERMISSION OF MINI-CIRCUITS.

SIZE

CODE IDENT

DRAWING NO:

REV:

A

15542

98-PL-137

A

FILE:

98PL137

SCALE:

10:1

SHEET:

1 OF 1

ASHEETA1.DWG REV:A DATE:01/12/95

Evaluation Board and Circuit

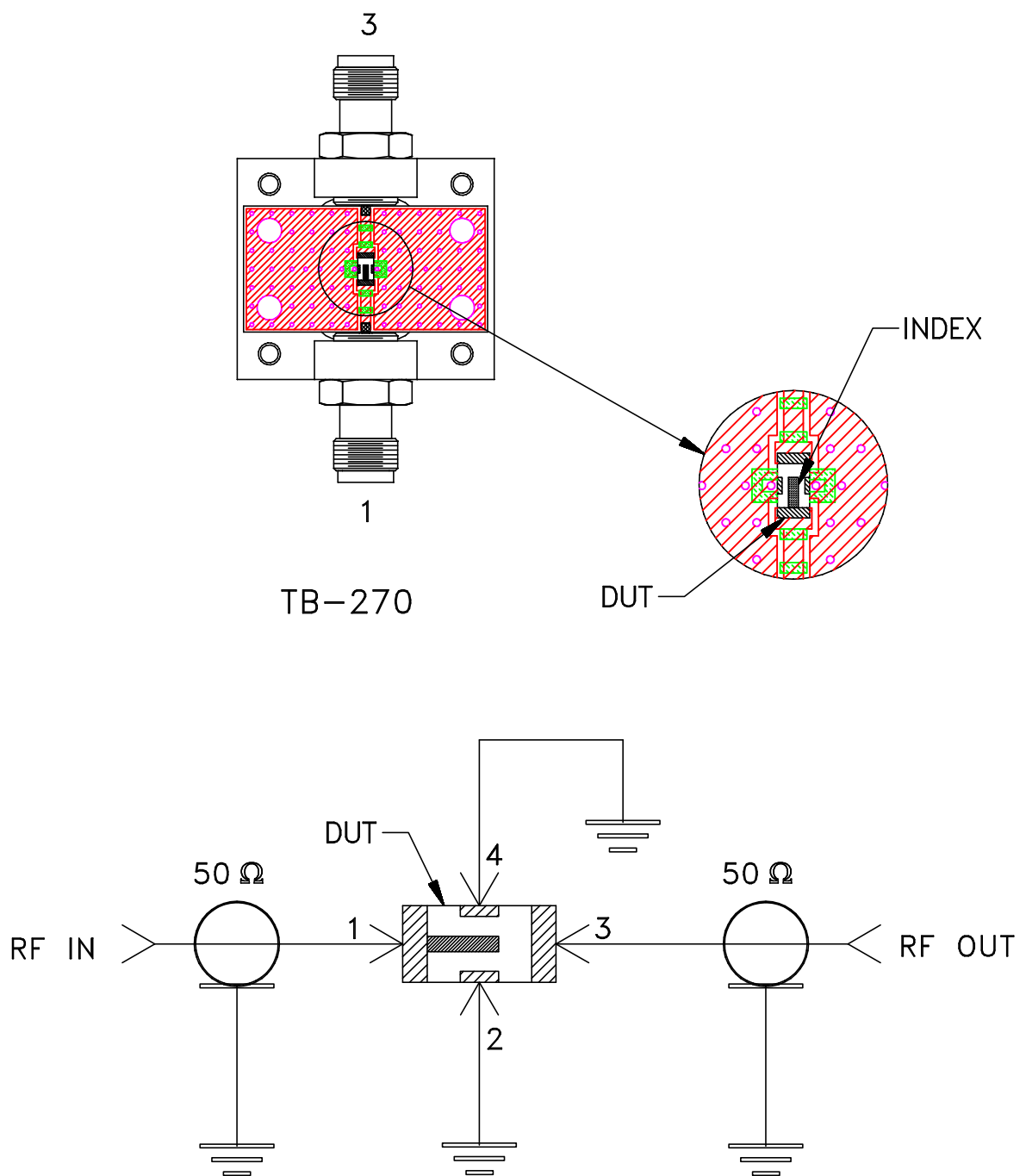

Schematic Diagram

Notes:

1. SMA Female connectors.
2. PCB Material: ROGERS R04350 or equivalent, Dielectric Constant=3.5, Thickness=.020 inch.

 **Mini-Circuits®**

All Mini-Circuits products are manufactured under exacting quality assurance and control standards, and are capable of meeting published specifications after being subjected to any or all of the following physical and environmental test.

Specification	Test/Inspection Condition	Reference/Spec
Operating Temperature	-55° to 100°C Ambient Environment	Individual Model Data Sheet
Storage Temperature	-55° to 100° C Ambient Environment	Individual Model Data Sheet
Humidity	90 to 95% RH, 240 hours, 50°C	MIL-STD-202, Method 103, Condition A, Except 50°C and end-point electrical test done within 12 hours
Solder Reflow Heat	Sn-Pb Eutetic Process: 225°C peak Pb-Free Process 245° - 250°C peak	J-STD-020, Table 4-1, 4-2 and 5-2, Figure 5-1
Solderability	10X Magnification	J-STD-002, Para 4.2.5, Test S, 95% Coverage
Vibration (High Frequency)	20g peak, 10-2000 Hz, 12 times in each of three perpendicular directions (total 36)	MIL-STD-202, Method 204, Condition D
Mechanical Shock	50g, 11 ms, 1/2-sine, 18 shocks: 3 each direction, each of 3 axes	MIL-STD-202, Method 213, Condition A