



CERAMIC

# Low Pass Filter

## LFCN-1500+

50Ω DC<sup>1</sup> to 1500 MHz

### FEATURES

- Excellent power handling, 10W
- Small size
- 7 sections
- Temperature stable
- LTCC construction
- Protected by U.S Patent 6,943,646

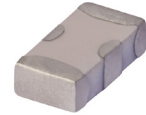

Generic photo used for illustration purposes only

CASE STYLE: FV1206

### APPLICATIONS

- Harmonic rejection
- VHF/UHF transmitters/receivers
- Lab use

#### +RoHS Compliant

The +Suffix identifies RoHS Compliance. See our web site for RoHS Compliance methodologies and qualifications

### ELECTRICAL SPECIFICATIONS<sup>1,2</sup> AT 25°C

Parameter	F#	Frequency (MHz)	Min.	Typ.	Max.	Units	
Passband	Insertion Loss	DC-F1	DC-1500	—	—	1.0	dB
	Freq. Cut-Off	F2	1825	—	3.0	—	dB
	VSWR	DC-F1	DC-1500	—	1.2	—	:1
Stop Band	Rejection Loss	F3	2100	20	—	—	dB
		F4-F5	2150-6600	—	30	—	
	VSWR	F6	6800	—	20	—	:1
		F3-F6	2100-6800	—	20	—	

1. In Applications where DC isolation to ground is required, coupling capacitors are recommended to avoid DC leakage. Alternatively, if DC pass IN-OUT is required, Mini-Circuits "D" suffix version of this model will support DC IN-OUT, and provide >100 MOhm isolation to ground.

2. Measured on Mini-Circuits Characterization Test Board TB-270.

### MAXIMUM RATINGS

Parameter	Ratings
Operating temperature	-55°C to 100°C
Storage temperature	-55°C to 100°C
RF Power Input <sup>3</sup>	10 W max. at 25°C

3. Passband rating, derate linearly to 3.5W at 100°C ambient. Permanent damage may occur if any of these limits are exceeded.

### TYPICAL FREQUENCY RESPONSE



### FUNCTIONAL SCHEMATIC

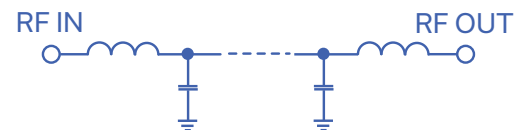

REV. K  
ECO-011538  
LFCN-1500+  
AD/CP/AM  
220119



CERAMIC

# Low Pass Filter

LFCN-1500+

## PIN CONNECTIONS

RF IN	1
RF OUT	3
GROUND	2,4

PRODUCT MARKING: N/A

DEMO BOARD MCL P/N: TB-270  
SUGGESTED PCB LAYOUT (PL-137)



- NOTES:**
1. COPLANAR WAVEGUIDE PARAMETERS ARE SHOWN FOR ROGERS RO4350B WITH THICKNESS .020" ± .0015". COPPER: 1/2 OZ. EACH SIDE. FOR OTHER MATERIALS TRACE WIDTH & GAP MAY NEED TO BE MODIFIED.
  2. BOTTOM SIDE OF THE PCB IS CONTINUOUS GROUND PLANE.

- DENOTES PCB COPPER LAYOUT WITH SMOBC (SOLDER MASK OVER BARE COPPER)
- DENOTES COPPER LAND PATTERN FREE OF SOLDER MASK

## OUTLINE DRAWING



## PCB Land Pattern



Suggested Layout,  
Tolerance to be within ±.002

## OUTLINE DIMENSIONS (Inches mm)

A	B	C	D	E	F	G
.126	.063	.037	.020	.032	.009	.169
3.20	1.60	0.94	0.51	0.81	0.23	4.29

H	J	K	L	M	N	P	wt
.087	.024	.122	.024	.087	.012	.071	grams
2.21	0.61	3.10	0.61	2.21	0.30	1.80	.020

TAPE & REEL INFORMATION: F71



CERAMIC

# Low Pass Filter

## LFCN-1500+

Mini-Circuits

### TYPICAL PERFORMANCE DATA AT 25°C

Frequency (MHz)	Insertion Loss (dB)	VSWR (:1)
100.00	0.09	1.03
1000.00	0.41	1.13
1500.00	0.77	1.19
1700.00	1.31	1.38
1825.00	2.99	2.33
2000.00	16.47	10.13
2100.00	34.49	14.62
2150.00	35.94	16.56
2500.00	37.94	27.16
3000.00	31.80	38.61
4000.00	42.25	49.64
5000.00	43.54	42.38
6000.00	36.93	28.49
6800.00	28.71	21.46
7000.00	16.97	12.01

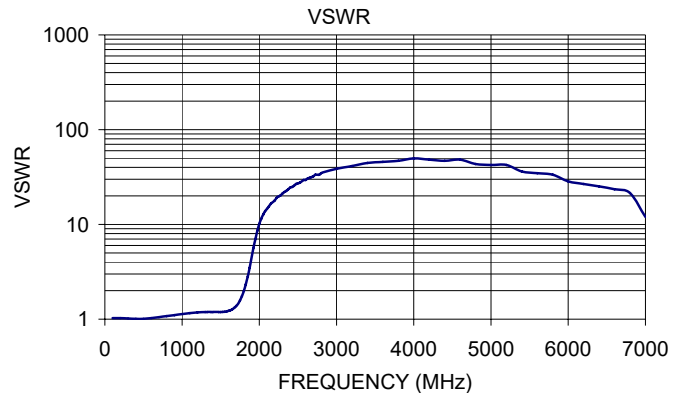

#### NOTES

- A. Performance and quality attributes and conditions not expressly stated in this specification document are intended to be excluded and do not form a part of this specification document.
- B. Electrical specifications and performance data contained in this specification document are based on Mini-Circuit's applicable established test performance criteria and measurement instructions.
- C. The parts covered by this specification document are subject to Mini-Circuits standard limited warranty and terms and conditions (collectively, "Standard Terms"); Purchasers of this part are entitled to the rights and benefits contained therein. For a full statement of the standard. Terms and the exclusive rights and remedies thereunder, please visit Mini-Circuits' website at [www.minicircuits.com/MCLStore/terms.jsp](http://www.minicircuits.com/MCLStore/terms.jsp)



# Ceramic Low Pass Filter

# LFCN-1500+

## Typical Performance Data

FREQ. (MHz)	INSERTION LOSS (dB)			INPUT RETURN LOSS (dB)			OUTPUT RETURNLOSS (dB)		
	@ -55° C	@ +25° C	@ +100° C	@ -55° C	@ +25° C	@ +100° C	@ -55° C	@ +25° C	@ +100° C
50	0.05	0.06	0.08	34.84	33.48	32.53	34.24	33.19	32.40
100	0.06	0.08	0.10	35.51	34.17	33.18	35.28	34.08	33.14
500	0.13	0.18	0.22	31.61	33.22	35.87	28.57	28.81	29.30
1000	0.25	0.33	0.40	23.38	23.39	23.17	22.28	22.05	21.53
1500	0.55	0.68	0.80	17.62	18.02	18.27	17.34	17.45	17.49
1560	0.61	0.75	0.89	18.14	18.59	18.95	17.50	17.62	17.77
1650	0.77	0.95	1.11	17.94	18.20	18.46	16.55	16.57	16.71
1710	1.00	1.23	1.43	15.58	15.41	15.37	14.41	14.27	14.30
1825	2.43	2.88	3.32	7.82	7.49	7.25	7.91	7.76	7.69
1870	3.92	4.56	5.20	5.10	4.90	4.75	5.50	5.46	5.44
1940	8.40	9.38	10.41	2.29	2.32	2.36	2.91	3.02	3.11
2025	18.00	19.44	20.96	1.01	1.17	1.32	1.63	1.80	1.93
2055	22.75	24.45	26.24	0.84	1.00	1.16	1.43	1.59	1.72
2100	32.68	35.08	37.39	0.69	0.86	1.02	1.21	1.36	1.48
2120	39.16	41.11	41.44	0.63	0.80	0.97	1.13	1.28	1.40
2150	41.82	39.80	38.56	0.57	0.75	0.90	1.05	1.19	1.31
2210	35.67	35.72	35.89	0.49	0.66	0.81	0.91	1.04	1.15
2345	46.21	47.40	47.92	0.37	0.53	0.68	0.69	0.81	0.92
2365	49.38	48.69	47.36	0.36	0.52	0.67	0.67	0.79	0.90
2415	42.76	41.69	40.69	0.34	0.50	0.65	0.63	0.75	0.86
2495	36.26	35.85	35.55	0.31	0.47	0.61	0.56	0.68	0.80
2850	30.44	30.58	30.68	0.24	0.40	0.54	0.41	0.54	0.67
3830	37.61	37.93	38.31	0.23	0.40	0.56	0.30	0.44	0.55
4020	39.16	39.51	39.87	0.18	0.35	0.49	0.34	0.47	0.57
4210	40.53	40.84	41.16	0.21	0.38	0.53	0.30	0.42	0.52
4400	40.77	41.14	41.31	0.22	0.38	0.51	0.32	0.44	0.53
4470	39.40	39.78	40.14	0.26	0.42	0.55	0.31	0.42	0.51
4640	40.37	39.98	40.40	0.23	0.41	0.52	0.32	0.44	0.52
5060	39.05	38.43	38.57	0.25	0.44	0.59	0.32	0.44	0.52
6600	27.62	27.68	28.03	0.57	0.81	1.13	0.45	0.64	0.82
6800	26.22	25.93	25.61	0.55	0.81	1.10	0.50	0.72	0.94
6940	21.91	21.22	20.00	0.70	0.94	1.31	0.83	1.06	1.51
7000	19.32	17.67	16.40	0.77	1.13	1.53	1.28	1.81	2.59
7070	14.26	12.47	11.88	1.25	1.83	2.20	2.81	4.58	6.10
7750	20.28	20.49	20.57	0.71	0.88	1.12	0.66	0.86	1.19
8440	19.28	19.39	19.37	0.71	0.98	1.31	0.77	0.96	1.20
10000	16.07	16.40	16.70	0.60	0.91	1.10	0.73	0.90	1.05
12380	8.42	8.52	9.16	1.61	2.50	3.54	1.95	2.57	3.27
12620	12.66	14.71	14.90	2.37	2.17	2.44	2.77	2.19	2.07
14000	8.53	8.81	9.19	2.60	3.25	4.00	2.44	2.88	3.32
15000	8.84	8.80	9.48	2.76	3.65	4.32	7.21	9.95	13.89

REV. X1  
LFCN-1500+  
080722  
Page 1 of 1



IF/RF MICROWAVE COMPONENTS • ISO 9001 ISO 14001 AS 9100 CERTIFIED • RoHS compliant  
P.O. Box 350166, Brooklyn, New York 11235-0003 (718) 934-4500 Fax (718) 332-4661



The Design Engineers Search Engine finds the model you need, Instantly • For detailed performance specs & shopping online see



# Ceramic Low Pass Filter

## Typical Performance Curves

# LFCN-1500+

### INSERTION LOSS vs. TEMPERATURE

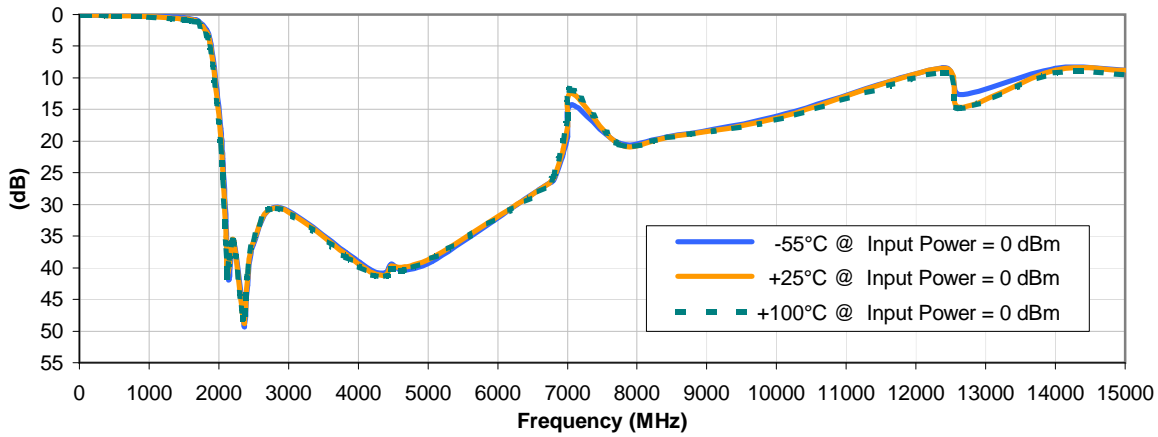

### INPUT RETURN LOSS vs. TEMPERATURE

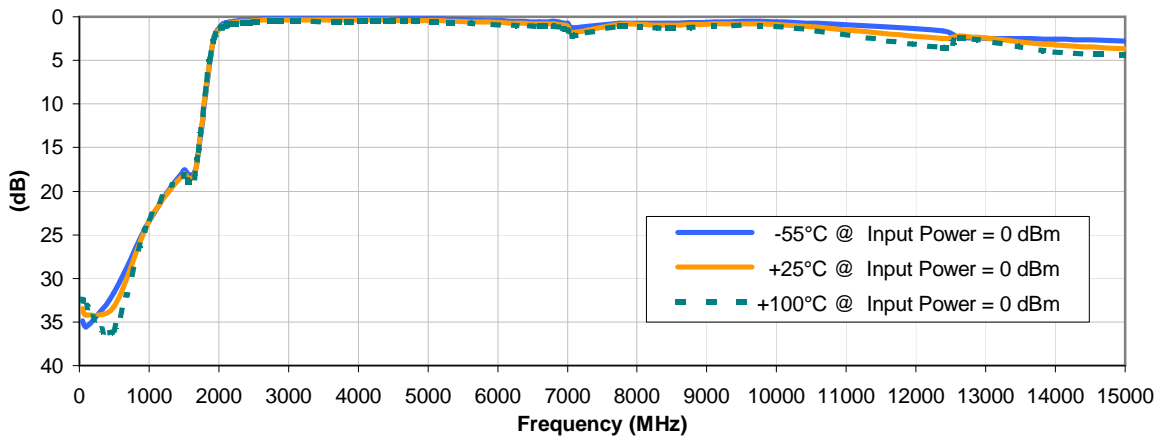

### OUTPUT RETURN LOSS vs. TEMPERATURE

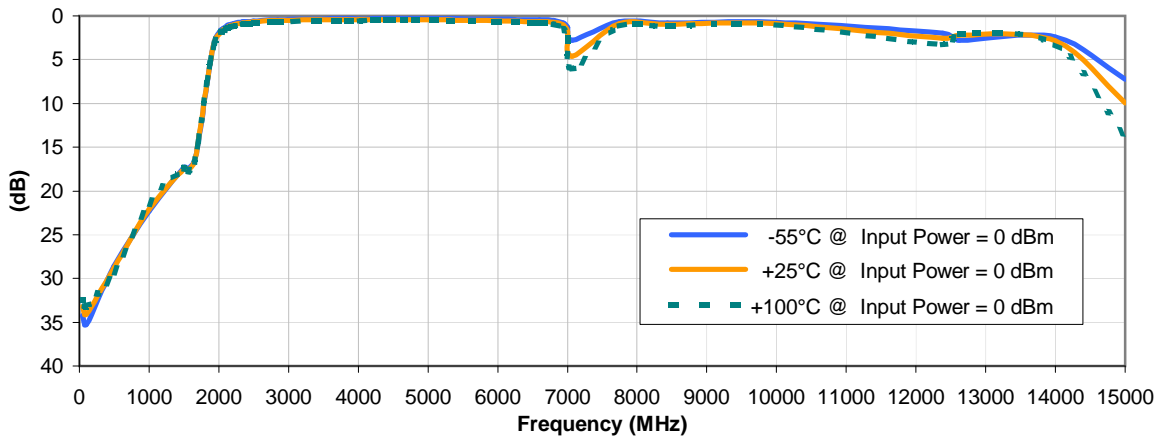

REV. X1  
LFCN-1500+  
080722  
Page 1 of 1



IF/RF MICROWAVE COMPONENTS • ISO 9001 ISO 14001 AS 9100 CERTIFIED • RoHS compliant  
P.O. Box 350166, Brooklyn, New York 11235-0003 (718) 934-4500 Fax (718) 332-4661



The Design Engineers Search Engine finds the model you need, Instantly • For detailed performance specs & shopping online see



### Outline Dimensions

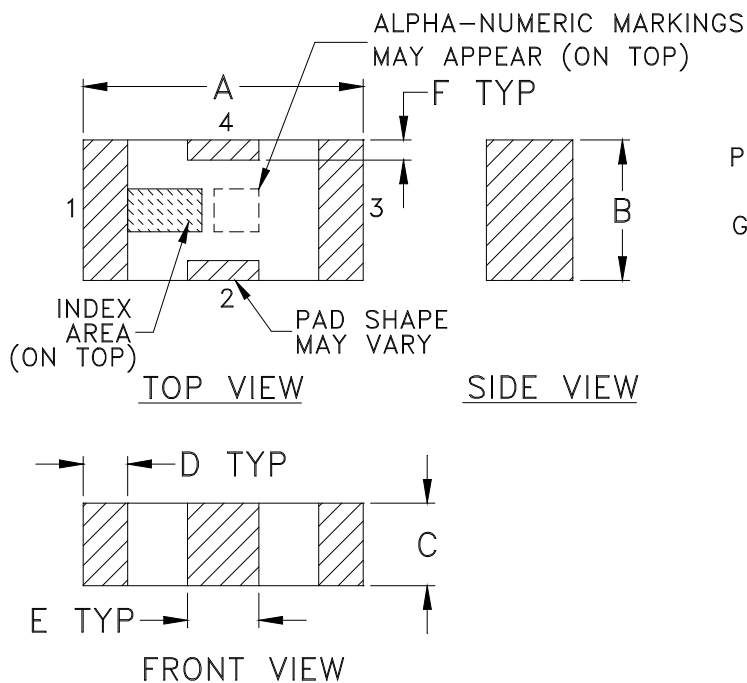

### PCB Land Pattern



Suggested Layout,  
Tolerance to be within  $\pm .002$

CASE #	A	B	C	D	E	F	G	H	J	K	L	M	N	P	WT. GRAM
FV1206	.126 (3.20)	.063 (1.60)	.037 (0.94)	.020 (0.51)	.032 (0.81)	.009 (0.23)	.169 (4.29)	.087 (2.21)	.024 (0.61)	.122 (3.10)	.024 (0.61)	.087 (2.21)	.012 (0.30)	.071 (1.80)	.020

Dimensions are in inches (mm). Tolerances: 2 Pl.  $\pm .01$ ; 3 Pl.  $\pm .005$

#### Notes:

- Open style, ceramic base.
- Termination finish: **as shown below or indicated on Data Sheet.**  
 For RoHS Case Styles: Tin plate over Nickel plate. All models, (+) suffix.  
 For RoHS-5 Case Styles: Tin-Lead plate. All models, no (+) suffix.



P.O. Box 350166, Brooklyn, New York 11235-0003 (718) 934-4500 Fax (718) 332-4661 For detailed performance specs & shopping online see Mini-Circuits web site



The Design Engineers Search Engine Provides ACTUAL Data Instantly From MINI-CIRCUITS At: [www.minicircuits.com](http://www.minicircuits.com)

RF/IF MICROWAVE COMPONENTS

# Tape & Reel Packaging TR-F71



ILLUSTRATION 1

Tape Width, mm	Device Cavity Pitch, mm	Reel Size, inches	Devices per Reel	
8	4	7	Small quantity standards (see note)	20
				50
				100
				200
				500
				1000
			Standard	3000

Note: Please Consult individual model data sheet to determine device per reel availability.

Mini-Circuits carrier tape materials provide protection from ESD (Electro-Static Discharge) during handling and transportation. Tapes are static dissipative and comply with industry standards EIA-481/EIA-541.

Go to: [www.minicircuits.com/pages/pdfs/tape.pdf](http://www.minicircuits.com/pages/pdfs/tape.pdf)



P.O. Box 350166, Brooklyn, New York 11235-0003 (718) 934-4500 Fax (718) 332-4661 For detailed performance specs & shopping online see Mini-Circuits web site



The Design Engineers Search Engine Provides ACTUAL Data Instantly From MINI-CIRCUITS At: [www.minicircuits.com](http://www.minicircuits.com)

RF/IF MICROWAVE COMPONENTS

THIRD ANGLE PROJECTION



REVISIONS

REV	ECN No.	DESCRIPTION	DATE	DR	AUTH
OR	M88634	NEW RELEASE	08/28/03	GF	ABD
A	M102713	ADDED "...WITH SMOBC"	01/17/06	MMG	IL

SUGGESTED MOUNTING CONFIGURATION  
FOR FV1206 CASE STYLE, "nx" PIN CONNECTION



- NOTES:**
1. COPLANAR WAVEGUIDE PARAMETERS ARE SHOWN FOR ROGERS R04350B WITH THICKNESS .020" ± .0015".  
 COPPER: 1/2 OZ. EACH SIDE.  
 FOR OTHER MATERIALS TRACE WIDTH & GAP MAY NEED TO BE MODIFIED.

2. BOTTOM SIDE OF THE PCB IS CONTINUOUS GROUND PLANE.



DENOTES PCB COPPER LAYOUT WITH SMOBC  
 (SOLDER MASK OVER BARE COPPER)



DENOTES COPPER LAND PATTERN FREE OF SOLDER MASK

UNLESS OTHERWISE SPECIFIED

INITIALS

DATE

DIMENSIONS ARE IN INCHES

DRAWN

GF

08/27/03

TOLERANCES ON:

CHECKED

AV

08/28/03

2 PL DECIMALS ±

APPROVED

ABD

08/28/03

3 PL DECIMALS ± .005

ANGLES ±

FRACTIONS ±



**Mini-Circuits®**

13 Neptune Avenue  
 Brooklyn NY 11235

PL, nx, FV1206, LFCN/HFCN, TB-270

THIS DOCUMENT AND ITS CONTENTS ARE THE PROPERTY OF MINI-CIRCUITS. EXCEPT FOR USE EXPRESSLY GRANTED, IN WRITING, TO ITS VENDORS, VENDEE AND THE UNITED STATES GOVERNMENT, MINI-CIRCUITS RESERVES ALL PROPRIETARY DESIGN, USE, MANUFACTURING AND REPRODUCTION RIGHTS THERETO. THESE CONTENTS SHALL NOT BE USED, DUPLICATED OR DISCLOSED TO ANY OUTSIDE PARTY, IN WHOLE OR IN PART, WITHOUT WRITTEN PERMISSION OF MINI-CIRCUITS.

SIZE

CODE IDENT

DRAWING NO:

REV:

A

15542

98-PL-137

A

FILE: 98PL137

SCALE:

10:1

SHEET:

1 OF 1

ASHEETA1.DWG REV:A DATE:01/12/95



# Evaluation Board and Circuit



Schematic Diagram

## Notes:

1. SMA Female connectors.
2. PCB Material: ROGERS R04350 or equivalent, Dielectric Constant=3.5, Thickness=.020 inch.

 **Mini-Circuits®**

All Mini-Circuits products are manufactured under exacting quality assurance and control standards, and are capable of meeting published specifications after being subjected to any or all of the following physical and environmental test.

Specification	Test/Inspection Condition	Reference/Spec
Operating Temperature	-55° to 100°C Ambient Environment	Individual Model Data Sheet
Storage Temperature	-55° to 100° C Ambient Environment	Individual Model Data Sheet
Humidity	90 to 95% RH, 240 hours, 50°C	MIL-STD-202, Method 103, Condition A, Except 50°C and end-point electrical test done within 12 hours
Solder Reflow Heat	Sn-Pb Eutetic Process: 225°C peak Pb-Free Process 245° - 250°C peak	J-STD-020, Table 4-1, 4-2 and 5-2, Figure 5-1
Solderability	10X Magnification	J-STD-002, Para 4.2.5, Test S, 95% Coverage
Vibration (High Frequency)	20g peak, 10-2000 Hz, 12 times in each of three perpendicular directions (total 36)	MIL-STD-202, Method 204, Condition D
Mechanical Shock	50g, 11 ms, 1/2-sine, 18 shocks: 3 each direction, each of 3 axes	MIL-STD-202, Method 213, Condition A