

# Miniature Surface Mount Fixed Attenuator

50Ω 0.5W 30dB DC to 1000 MHz

## LAT-30+



CASE STYLE: MMM168  
PRICE: \$1.95 ea. QTY (20)

### +RoHS Compliant

The +Suffix identifies RoHS Compliance. See our web site for RoHS Compliance methodologies and qualifications



Available Tape and Reel  
at no extra cost

Reel Size	Devices/Reel
7"	20, 50, 100, 200, 500, 1000, 2000, 3000

### Maximum Ratings

Operating Temperature	-55°C to 85°C
Storage Temperature	-55°C to 100°C

Permanent damage may occur if any of these limits are exceeded.

### Pin Connections

INPUT	4
OUTPUT	2
GROUND	1,3

### Outline Drawing

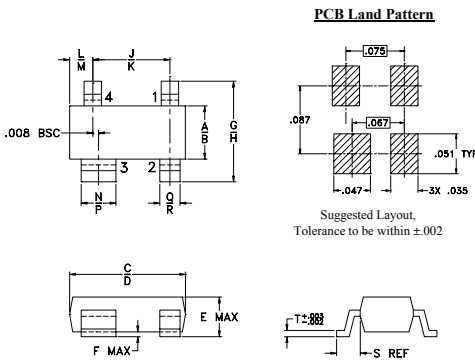

### Outline Dimensions (inch/mm)

A	B	C	D	E	F	G	H	J	K	
.045	.055	.105	.120	.047	.005	.083	.104	.070	.080	
1.14	1.40	2.67	3.05	1.19	0.13	2.11	2.64	1.78	2.03	
L	M	N	P	Q	R	S	T			wt
.018	.024	.030	.036	.015	.021	.023	.005			grams
0.46	0.61	0.76	0.91	0.38	0.53	0.58	0.13			0.01

### Demo Board MCL P/N: TB-39 Suggested PCB Layout (PL-225)

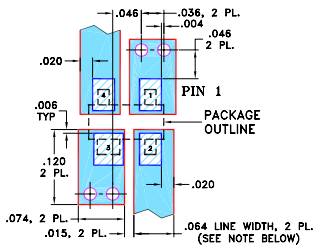

NOTES: 1. TRACE WIDTH IS SHOWN FOR ROGERS RO4350B WITH DIELECTRIC THICKNESS .030" ± .002"; COPPER: 1/2 OZ. EACH SIDE. FOR OTHER MATERIALS TRACE WIDTH MAY NEED TO BE MODIFIED.  
2. BOTTOM SIDE OF THE PCB IS CONTINUOUS GROUND PLANE.

- DENOTES PCB COPPER LAYOUT WITH SMOBC (SOLDER MASK OVER BARE COPPER)
- DENOTES COPPER LAND PATTERN FREE OF SOLDER MASK

### Notes

- Performance and quality attributes and conditions not expressly stated in this specification document are intended to be excluded and do not form a part of this specification document.
- Electrical specifications and performance data contained in this specification document are based on Mini-Circuit's applicable established test performance criteria and measurement instructions.
- The parts covered by this specification document are subject to Mini-Circuits standard limited warranty and terms and conditions (collectively, "Standard Terms"); Purchasers of this part are entitled to the rights and benefits contained therein. For a full statement of the Standard Terms and the exclusive rights and remedies thereunder, please visit Mini-Circuits' website at [www.minicircuits.com/MCLStore/terms.jsp](http://www.minicircuits.com/MCLStore/terms.jsp)

### Features

- wideband, DC to 1000 MHz
- excellent VSWR, through entire band
- miniature size, SOT143 package
- aqueous washable

### Applications

- cellular
- PCS
- ISM
- VHF/UHF

### Electrical Specifications at 25°C

FREQ. RANGE (MHz)	ATTENUATION (dB) Flatness, Max.	VSWR (:1) Max.		MAX. INPUT POWER <sup>1</sup> (W)
		DC-0.5 GHz	DC-1 GHz	
$f_L$ - $f_U$	Nom.	DC-0.5 GHz	DC-1 GHz	
DC-1000	30±1.7	1.2	1.3	0.5

- RF power at 25°C case temperature: ½Watt. Derate linearly to 0.2 Watt at 85°C.
- Flatness= variation over band divided by 2

### Typical Performance Data

Frequency (MHz)	Attenuation (dB)	VSWR (:1)
0.50	30.07	1.04
100.00	30.08	1.04
200.00	30.13	1.04
300.00	30.21	1.06
400.00	30.33	1.08
500.00	30.48	1.09
650.00	30.78	1.11
750.00	31.04	1.13
850.00	31.32	1.14
1000.00	31.87	1.17

LAT-30+  
ATTENUATION

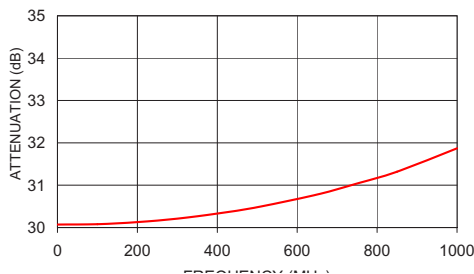

LAT-30+  
VSWR

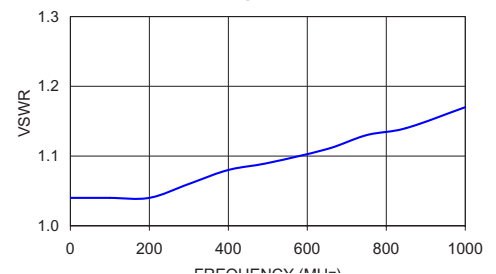

# Fixed Attenuator

# LAT-30+

## Typical Performance Data

FREQUENCY (MHz)	ATTENUATION (dB)	VSWR (:1)
0.5	30.07	1.04
1.0	30.05	1.04
2.0	30.05	1.04
4.0	30.05	1.04
6.0	30.05	1.04
8.0	30.04	1.04
10.0	30.04	1.04
30.0	30.05	1.04
50.0	30.06	1.04
70.0	30.07	1.04
90.0	30.07	1.04
100.0	30.08	1.04
150.0	30.10	1.04
200.0	30.13	1.04
250.0	30.17	1.05
300.0	30.21	1.06
350.0	30.27	1.07
400.0	30.33	1.08
450.0	30.40	1.08
500.0	30.48	1.09
550.0	30.57	1.10
600.0	30.68	1.11
650.0	30.78	1.11
700.0	30.90	1.12
750.0	31.04	1.13
800.0	31.17	1.14
850.0	31.32	1.14
900.0	31.49	1.15
1000.0	31.87	1.17
1100.0	32.29	1.18
1200.0	32.78	1.20
1300.0	33.32	1.21
1400.0	33.94	1.23
1500.0	34.63	1.24
1600.0	35.32	1.26
1700.0	36.01	1.27
1800.0	36.61	1.29
1900.0	36.94	1.30
2000.0	36.81	1.32



## Typical Performance Curves

### Attenuation

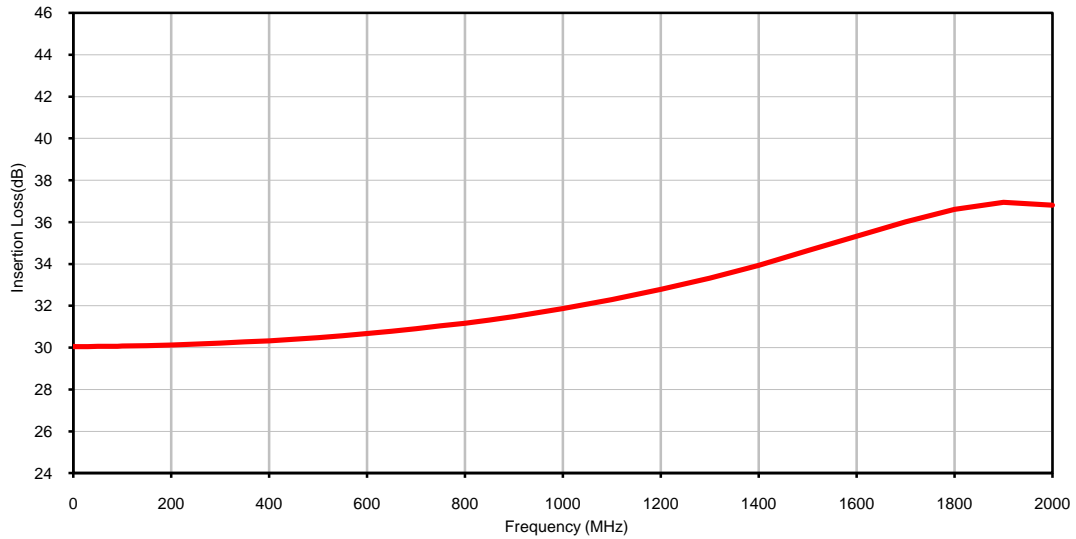

### VSWR

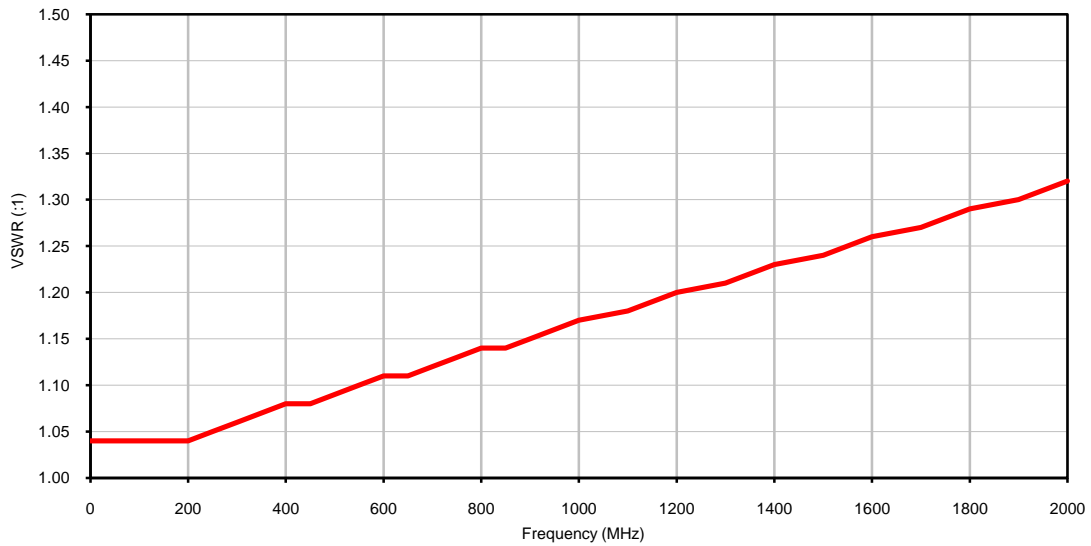

### Outline Dimensions

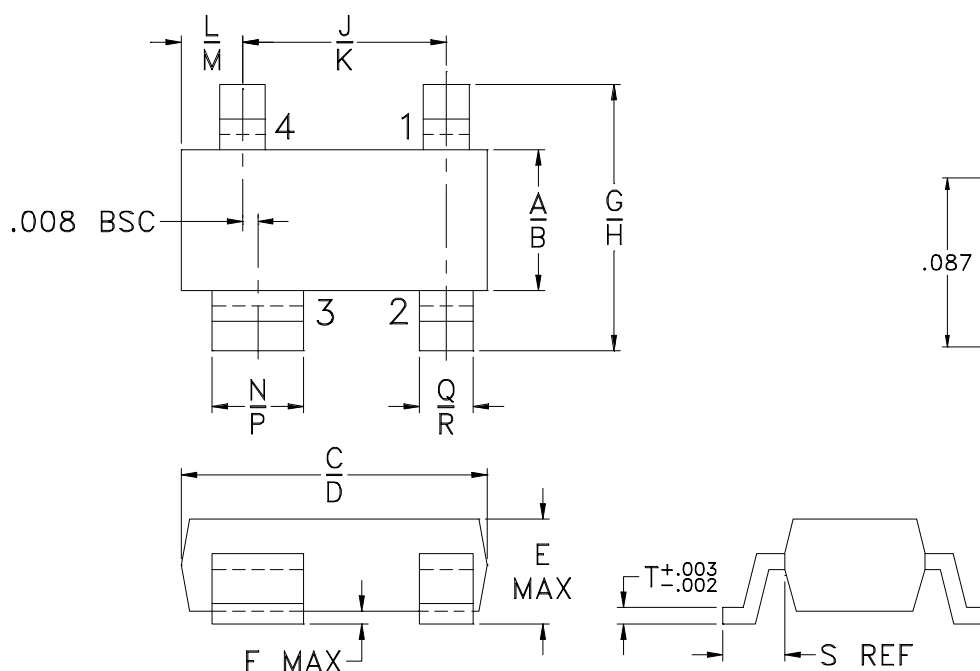

### PCB Land Pattern

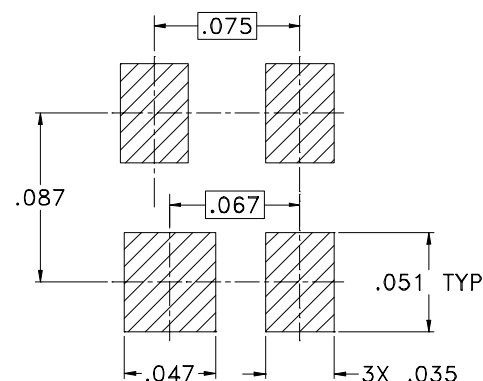

Suggested Layout,  
Tolerance to be within  $\pm .002$

CASE #.	A	B	C	D	E	F	G	H	J	K	L	M	N	P
MMM168	.045 (1.14)	.055 (1.40)	.105 (2.67)	.120 (3.05)	.047 (1.19)	.005 (0.13)	.083 (2.11)	.104 (2.64)	.070 (1.78)	.080 (2.03)	.018 (0.46)	.024 (0.61)	.030 (0.76)	.036 (0.91)

CASE #.	Q	R	S	T	WT, GRAM
MMM168	.015 (0.38)	.021 (0.53)	.023 (0.58)	.005 (0.13)	.01

Dimensions are in inches (mm). Tolerances: 2 Pl.  $\pm .01$ ; 3 Pl.  $\pm .005$

#### Notes:

1. Case material: Plastic.
2. Termination finish:

For RoHS Case Styles: Tin-Silver alloy plate over Nickel barrier.

For RoHS-5 Case Styles: Tin-Lead plate.

# Tape & Reel Packaging TR-F8

## DEVICE ORIENTATION IN T&R

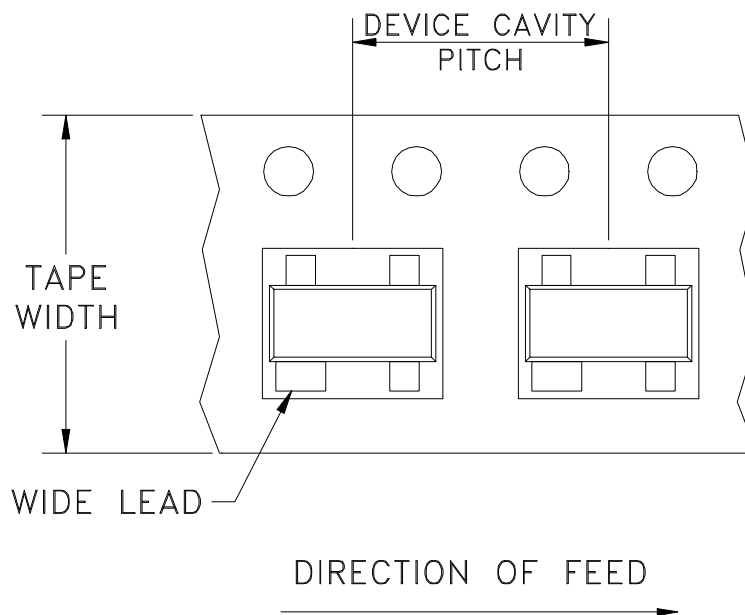

Tape Width, mm	Device Cavity Pitch, mm	Reel Size, inches	Devices per Reel
8	4	7	3000

Mini-Circuits carrier tape materials provide protection from ESD (Electro-Static Discharge) during handling and transportation. Tapes are static dissipative and comply with industry standards EIA-481/EIA-541.

Go to: [www.minicircuits.com/pages/pdfs/tape.pdf](http://www.minicircuits.com/pages/pdfs/tape.pdf)



INTERNET <http://www.minicircuits.com>

P.O. Box 350166, Brooklyn, New York 11235-0003 (718) 934-4500 Fax (718) 332-4661

Distribution Centers NORTH AMERICA 800-654-7949 • 417-335-5935 • Fax 417-335-5945 • EUROPE 44-1252-832600 • Fax 44-1252-837010

Mini-Circuits ISO 9001 & ISO 14001 Certified

THIRD ANGLE PROJECTION

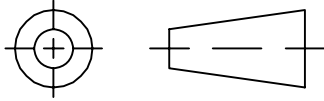

REVISIONS

REV	ECN No.	DESCRIPTION	DATE	DR	AUTH
OR	M101091	NEW RELEASE	02/03/06	MMG	MM

SUGGESTED MOUNTING CONFIGURATION FOR  
MMM168 CASE STYLE, "jk" PIN CONNECTION

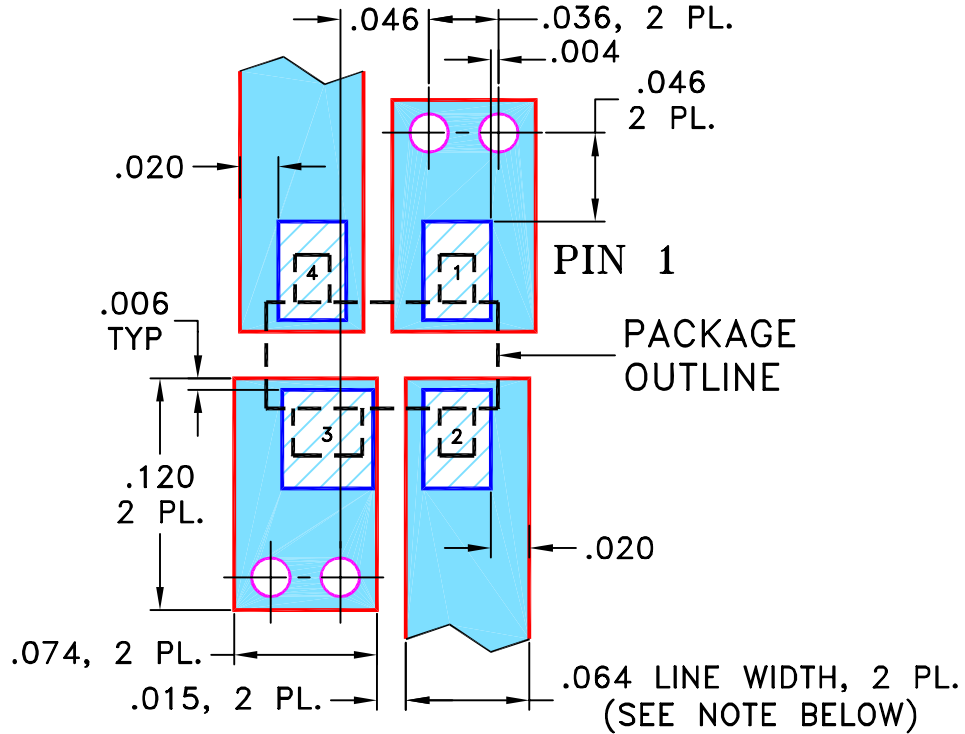

- NOTES:** 1. TRACE WIDTH IS SHOWN FOR ROGERS RO4350B WITH DIELECTRIC THICKNESS  $.030'' \pm .002''$ ; COPPER: 1/2 OZ. EACH SIDE. FOR OTHER MATERIALS TRACE WIDTH MAY NEED TO BE MODIFIED.  
2. BOTTOM SIDE OF THE PCB IS CONTINUOUS GROUND PLANE.



DENOTES PCB COPPER LAYOUT WITH SMOBC (SOLDER MASK OVER BARE COPPER)

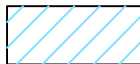

DENOTES COPPER LAND PATTERN FREE OF SOLDER MASK

UNLESS OTHERWISE SPECIFIED

INITIALS

DATE

DIMENSIONS ARE IN INCHES

DRAWN

MMG

12/12/05

TOLERANCES ON:

CHECKED

AV

01/03/06

2 PL DECIMALS  $\pm$

APPROVED

MM

02/03/06

3 PL DECIMALS  $\pm .005$

ANGLES  $\pm$

FRACTIONS  $\pm$

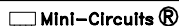

THIS DOCUMENT AND ITS CONTENTS ARE THE PROPERTY OF MINI-CIRCUITS. EXCEPT FOR USE EXPRESSLY GRANTED, IN WRITING, TO ITS VENDORS, VENDEE AND THE UNITED STATES GOVERNMENT, MINI-CIRCUITS RESERVES ALL PROPRIETARY DESIGN, USE, MANUFACTURING AND REPRODUCTION RIGHTS THERETO. THESE CONTENTS SHALL NOT BE USED, DUPLICATED OR DISCLOSED TO ANY OUTSIDE PARTY, IN WHOLE OR IN PART, WITHOUT WRITTEN PERMISSION OF MINI-CIRCUITS.

ASHEETA1.DWG REV:A DATE:01/12/95



Mini-Circuits®

13 Neptune Avenue  
Brooklyn NY 11235

PL, jk, MMM168, LAT, TB-39

SIZE  
A

CODE IDENT  
15542

DRAWING NO:  
98-PL-225

REV:  
OR

FILE: 98PL225

SCALE: 10:1

SHEET: 1 OF 1

# Evaluation Board and Circuit

For Pin Connections refer to Data Sheet of the DUT

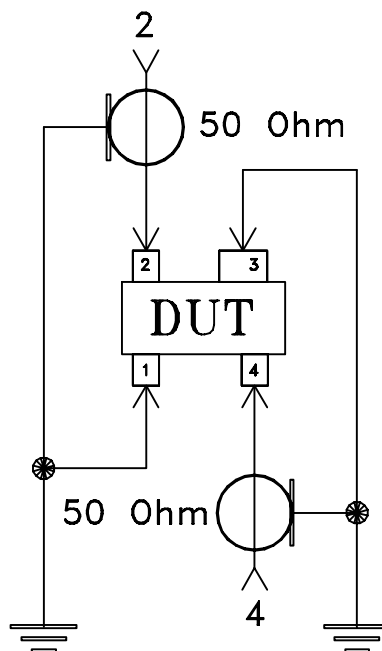
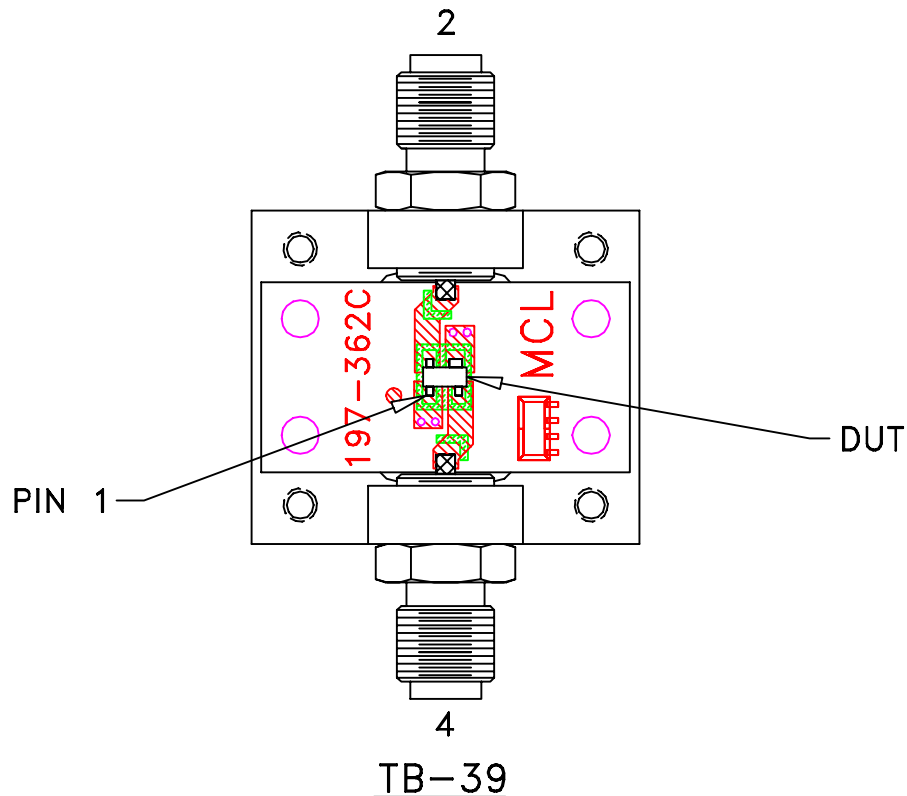

Schematic Diagram

## Notes:

1. SMA Female connectors.
2. PCB Material: Rogers R04350 or equivalent, Dielectric Constant=3.5, Thickness=.030 inch.

 Mini-Circuits®

All Mini-Circuits products are manufactured under exacting quality assurance and control standards, and are capable of meeting published specifications after being subjected to any or all of the following physical and environmental test.

Specification	Test/Inspection Condition	Reference/Spec
Operating Temperature	-55° to 85°C Ambient Environment	Individual Model Data Sheet
Storage Temperature	-55° to 100° C Ambient Environment	Individual Model Data Sheet
Thermal Shock	-55° to 100°C, 100 cycles	MIL-STD-202, Method 107, Condition A-3, except +100°C
Mechanical Shock	1.5Kg, 0.5 ms, 5 shock pulses, Y1 direction only	MIL-STD-883, Method 2002, Condition B, except Y1 direction only
Vibration (Variable Frequency)	50g peak	MIL-STD-883, Method 2007, Condition B
Autoclave	15 psig, 100% RH, 121°C, 96 hours	JESD22-A102, Condition C
HAST	130°C, 85% RH, 96 hours	JESD22-A110
Solderability	10X Magnification	J-STD-002, Para 4.2.5, Test S, 95% Coverage
Solder Reflow Heat	Sn-Pb Eutetic Process: 240°C peak Pb-Free Process: 260°C peak	J-STD-020, Table 4-1, 4-2 and 5-2; Figure 5-1
Moisture Sensitivity: Level 1	Bake at 125°C for 24 hours Soak at 85°C/85% RH for 168 hours, Reflow 3 cycles at 260°C peak	J-STD-020
Marking Resistance to Solvents	Isopropyl alcohol + mineral spirits at 25°C; terpene defluxer at 25°C; distilled water + proylene glycol monomethyl ether +	MIL-STD-202, Method 215





All Mini-Circuits products are manufactured under exacting quality assurance and control standards, and are capable of meeting published specifications after being subjected to any or all of the following physical and environmental test.

Specification	Test/Inspection Condition	Reference/Spec
---------------	---------------------------	----------------

monoethanolamine at 63°C to 70°C