



MICROWAVE PRECISION

# Fixed Attenuator

KAT-8+

50Ω 1.2W 8dB DC to 43.5 GHz

## THE BIG DEAL

- Super wide bandwidth, DC-43.5 GHz
- High Power Handling, 1.2W
- Small package, 2x2 MCLP™
- Excellent VSWR, 1.12:1 typ.



Generic photo used for illustration purposes only

CASE STYLE: MC1630-1

### +RoHS Compliant

The +Suffix identifies RoHS Compliance. See our website for methodologies and qualifications

## APPLICATIONS

- 5G
- Test and Measurement
- Radar
- Communication
- Defense

## PRODUCT OVERVIEW

KAT-8+ is an absorptive fixed attenuator fabricated using highly reliable and repeatable GaAs MMIC IPD process. The model operates from DC to 43.5GHz. It achieves outstanding attenuation accuracy and flatness while maintains excellent VSWR throughout the entire band. The model can also handle input power up to 1.2W, which makes this model an ideal choice for a wide range of applications.

## KEY FEATURES

Feature	Advantages
Wideband operation, From DC to 43.5 GHz	Supports a wide array of applications including 5G, wireless infrastructure, microwave communications, satellite, defense and aerospace, medical broadband and optic applications.
Small Size and simple to use (2 mm x 2 mm)	As a single chip solution, the KAT series occupies less board space than a lumped element approach, minimizes component count and ensures repeatable performance over wide frequency range.
Wide range of nominal attenuation values (0,1,2,3,4,5,6,7,8,9,10,12,15,20 & 30)	Small increment offering enables circuit designer to change attenuation values without motherboard redesign making the KAT series ideal for select at test application.
MCLP™ Package	Low Inductance, repeatable transitions, excellent thermal path make the KAT series an ideal solution as an alternative to "do it yourself" lumped element-based approach.

\* IPD - Integrated Passive Device.

REV. B  
ECO-014625  
KAT-8+  
MCL NY  
220818





MICROWAVE PRECISION

# Fixed Attenuator

KAT-8+

50Ω 1.2W 8dB DC to 43.5 GHz

## ELECTRICAL SPECIFICATIONS<sup>1</sup> AT 25°C, 50Ω, UNLESS NOTED OTHERWISE

Parameter	Condition (GHz)	Min.	Typ.	Max.	Unit
Frequency Range		DC	—	43.5	GHz
Attenuation	0.01 - 5	7.7	8.0	8.4	dB
	5 - 10	7.6	8.0	8.4	
	10 - 20	7.6	8.0	8.6	
	20 - 30	7.6	8.2	9.0	
	30 - 40	—	8.4	—	
	40 - 43.5	—	8.6	—	
VSWR	0.01 - 5	—	1.06	1.3	:1
	5 - 10	—	1.09	1.4	
	10 - 20	—	1.12	1.7	
	20 - 30	—	1.30	—	
	30 - 40	—	1.53	—	
	40 - 43.5	—	1.52	—	

1. Tested on Mini-Circuits test board TB-934-8C+. See Characterization/Application Circuit in Fig. 1

## MAXIMUM RATINGS<sup>2</sup>

Parameter	Ratings
Operating Case Temperature <sup>3</sup>	-40°C to 85°C
Storage Temperature	-65°C to 150°C
RF Input Power	1.2W <sup>3</sup>

2. Permanent damage may occur if any of these limits are exceeded.

3. Power rating derated to 0.9W at 85°C





MICROWAVE PRECISION

# Fixed Attenuator

**KAT-8+**

50Ω 1.2W 8dB DC to 43.5 GHz

## PAD DESCRIPTION

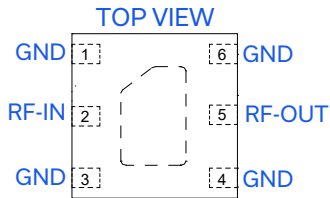

Function	Pad Number	Description
RF-IN	2	RF input pad
RF-OUT	5	RF output pad
GND	1,3,4,6 & Paddle	Ground

## CHARACTERIZATION TEST CIRCUIT

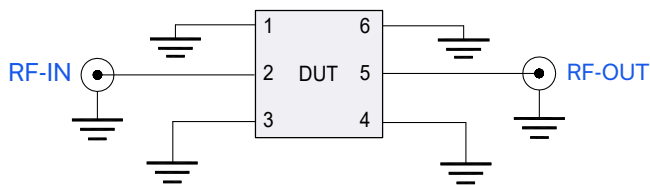
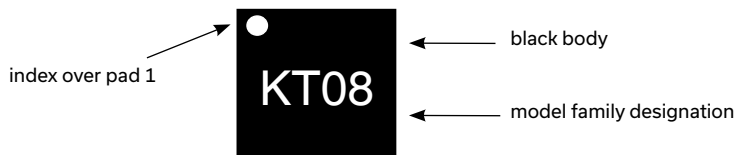

Fig 1. Block diagram of Test Circuit used for characterization, Test board TB-934-8C+ Conditions: Attenuation, VSWR: Pin=0 dBm

## PRODUCT MARKING



Marking may contain other features or characters for internal lot control



MICROWAVE PRECISION

# Fixed Attenuator

## KAT-8+

50Ω 1.2W 8dB DC to 43.5 GHz

### TYPICAL PERFORMANCE DATA AT 25°C

Frequency (GHz)	Attenuation (dB)	VSWR (:1)
0.01	7.99	1.09
0.5	8.00	1.08
1.0	7.99	1.10
3.0	7.98	1.17
5.0	7.98	1.21
7.0	8.04	1.26
10.0	7.94	1.25
12.0	7.96	1.18
15.0	7.95	1.18
20.0	7.98	1.20
25.0	8.07	1.36
30.0	8.12	1.39
35.0	8.22	1.55
38.0	8.38	1.70
43.5	8.67	1.62

KAT-8+  
ATTENUATION

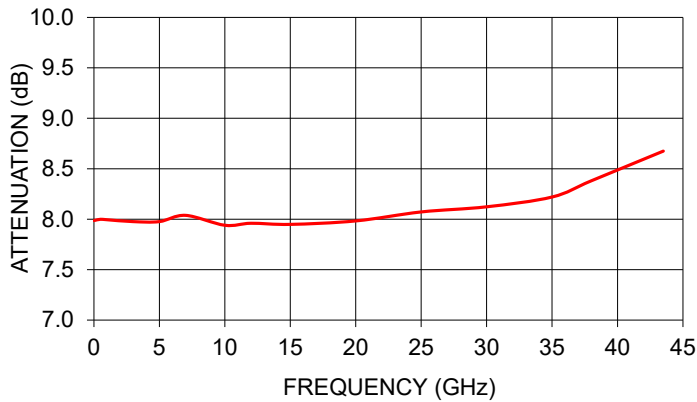

KAT-8+  
VSWR

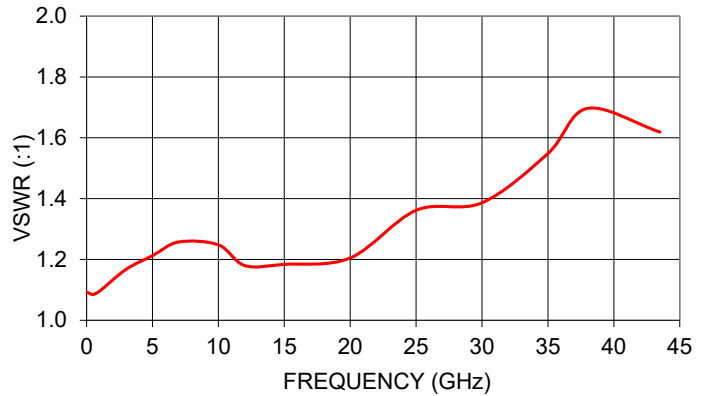



MICROWAVE PRECISION

# Fixed Attenuator

**KAT-8+**

50Ω 1.2W 8dB DC to 43.5 GHz

ADDITIONAL DETAILED TECHNICAL INFORMATION IS AVAILABLE ON OUR DASH BOARD. TO ACCESS [CLICK HERE](#)

Performance Data	Data Table Swept Graphs
Case Style	MC1630-1 Plastic package, Terminal finish: Matte Tin
Tape & Reel	F66
Standard quantities available on reel	7" reels with 20, 50, 100, 200, 500, 1K, 2K devices.
Suggested Layout for PCB Design	PL-586
Evaluation Board	TB-934-8C+
Environmental Ratings	ENV08T1

## ESD RATING

Human Body Model (HBM): Class 2 (Pass 2000V) per ANSI/ESD STM 5.1 - 2001

### NOTES

- A. Performance and quality attributes and conditions not expressly stated in this specification document are intended to be excluded and do not form a part of this specification document.
- B. Electrical specifications and performance data contained in this specification document are based on Mini-Circuit's applicable established test performance criteria and measurement instructions.
- C. The parts covered by this specification document are subject to Mini-Circuits standard limited warranty and terms and conditions (collectively, "Standard Terms"); Purchasers of this part are entitled to the rights and benefits contained therein. For a full statement of the standard terms and the exclusive rights and remedies thereunder, please visit Mini-Circuits' website at [www.minicircuits.com/terms/viewterm.html](http://www.minicircuits.com/terms/viewterm.html)



Typical Performance Data

FREQ.	ATTENUATION			INPUT VSWR			OUTPUT VSWR		
(MHz)	(dB)			(:1)			(:1)		
	@-45°C	@25°C	@+85°C	@-45°C	@25°C	@+85°C	@-45°C	@25°C	@+85°C
10	7.99	7.99	7.99	1.10	1.11	1.11	1.11	1.11	1.11
50	7.99	7.99	7.99	1.10	1.11	1.11	1.10	1.11	1.11
100	7.99	7.99	7.99	1.10	1.10	1.11	1.10	1.11	1.11
500	8.01	8.02	8.03	1.09	1.10	1.10	1.09	1.10	1.10
1000	8.02	8.04	8.04	1.10	1.10	1.11	1.10	1.10	1.11
1500	8.03	8.04	8.05	1.11	1.11	1.12	1.11	1.11	1.12
2000	8.03	8.05	8.05	1.12	1.13	1.13	1.12	1.12	1.13
2500	8.02	8.04	8.05	1.13	1.14	1.15	1.13	1.14	1.14
3000	8.01	8.04	8.04	1.15	1.15	1.16	1.13	1.15	1.15
3500	8.01	8.03	8.04	1.16	1.17	1.17	1.14	1.16	1.16
4000	8.00	8.02	8.03	1.17	1.17	1.18	1.15	1.16	1.17
4500	7.99	8.02	8.03	1.17	1.18	1.19	1.15	1.16	1.17
5000	8.00	8.03	8.04	1.18	1.19	1.19	1.16	1.17	1.17
5500	8.01	8.04	8.06	1.19	1.20	1.20	1.17	1.18	1.18
6000	8.03	8.06	8.08	1.20	1.21	1.21	1.18	1.19	1.19
6500	8.05	8.09	8.10	1.21	1.22	1.23	1.20	1.20	1.21
7000	8.06	8.10	8.12	1.22	1.23	1.24	1.21	1.22	1.22
7500	8.05	8.09	8.11	1.23	1.24	1.24	1.22	1.23	1.24
8000	8.03	8.08	8.10	1.23	1.24	1.25	1.23	1.24	1.25
8500	8.00	8.04	8.06	1.23	1.24	1.24	1.23	1.24	1.25
9000	7.97	8.01	8.03	1.22	1.22	1.23	1.23	1.23	1.24
9500	7.94	7.99	8.01	1.19	1.20	1.20	1.21	1.21	1.22
10000	7.93	7.98	8.00	1.16	1.16	1.16	1.18	1.18	1.19
10500	7.94	7.98	8.00	1.12	1.12	1.12	1.14	1.14	1.15
11000	7.95	7.99	8.01	1.09	1.08	1.08	1.10	1.10	1.11
11500	7.96	8.00	8.02	1.08	1.06	1.05	1.07	1.07	1.07
12000	7.96	8.00	8.02	1.10	1.07	1.06	1.08	1.07	1.06
12500	7.97	8.01	8.03	1.13	1.10	1.09	1.10	1.09	1.08
13000	7.97	8.01	8.03	1.16	1.13	1.12	1.13	1.11	1.10
13500	7.97	8.01	8.03	1.18	1.15	1.14	1.15	1.13	1.12
14000	7.97	8.01	8.03	1.19	1.16	1.15	1.15	1.14	1.13
14500	7.97	8.01	8.04	1.19	1.16	1.15	1.15	1.15	1.14
15000	7.97	8.01	8.04	1.18	1.15	1.15	1.15	1.14	1.14
15500	7.96	8.01	8.04	1.16	1.14	1.14	1.14	1.14	1.13
16000	7.96	8.01	8.04	1.14	1.13	1.12	1.13	1.13	1.13
16500	7.96	8.01	8.05	1.11	1.11	1.10	1.11	1.12	1.12
17000	7.95	8.01	8.04	1.09	1.09	1.08	1.10	1.11	1.10
17500	7.94	8.00	8.04	1.06	1.06	1.06	1.08	1.09	1.08
18000	7.93	8.00	8.03	1.04	1.04	1.03	1.05	1.06	1.06
18500	7.92	7.99	8.03	1.02	1.01	1.02	1.02	1.03	1.02
19000	7.92	7.99	8.03	1.04	1.04	1.05	1.02	1.01	1.01
19500	7.93	8.01	8.04	1.08	1.08	1.09	1.07	1.05	1.05
20000	7.95	8.03	8.06	1.13	1.12	1.12	1.11	1.09	1.09
21000	8.00	8.08	8.10	1.21	1.19	1.18	1.19	1.17	1.15
22000	8.03	8.10	8.11	1.26	1.23	1.20	1.23	1.20	1.17
23000	8.02	8.09	8.10	1.25	1.22	1.19	1.22	1.20	1.16
24000	8.00	8.07	8.10	1.23	1.21	1.19	1.20	1.18	1.15
25000	7.99	8.07	8.12	1.24	1.24	1.23	1.20	1.19	1.18
26000	8.03	8.12	8.18	1.28	1.29	1.30	1.22	1.22	1.23
27000	8.06	8.15	8.23	1.31	1.32	1.35	1.25	1.24	1.27
28000	8.05	8.15	8.23	1.31	1.32	1.34	1.26	1.25	1.27
29000	8.05	8.15	8.22	1.27	1.28	1.28	1.25	1.25	1.25
30000	8.04	8.14	8.19	1.24	1.24	1.23	1.24	1.24	1.23
31000	8.03	8.15	8.18	1.25	1.24	1.21	1.25	1.25	1.23
32000	8.05	8.17	8.21	1.28	1.28	1.26	1.28	1.28	1.27
33000	8.10	8.22	8.29	1.33	1.35	1.34	1.32	1.32	1.31
34000	8.13	8.25	8.34	1.39	1.41	1.41	1.34	1.34	1.34
35000	8.16	8.27	8.35	1.45	1.45	1.48	1.34	1.34	1.35
36000	8.19	8.30	8.36	1.49	1.48	1.50	1.35	1.36	1.36
37000	8.22	8.34	8.37	1.52	1.51	1.50	1.41	1.41	1.39
38000	8.25	8.40	8.40	1.56	1.55	1.51	1.50	1.49	1.45
39000	8.23	8.37	8.39	1.60	1.58	1.54	1.56	1.55	1.50
40000	8.10	8.24	8.28	1.59	1.58	1.56	1.56	1.55	1.52
41000	7.92	8.05	8.13	1.53	1.53	1.54	1.46	1.47	1.47
42000	7.74	7.88	7.99	1.48	1.50	1.52	1.32	1.34	1.37
43000	7.45	7.62	7.76	1.52	1.55	1.58	1.23	1.24	1.27
43500	7.33	7.52	7.69	1.58	1.62	1.64	1.23	1.22	1.23



## Typical Performance Curves

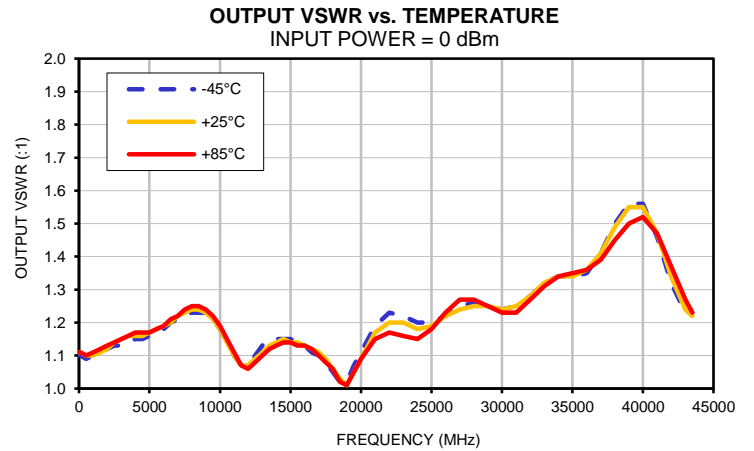
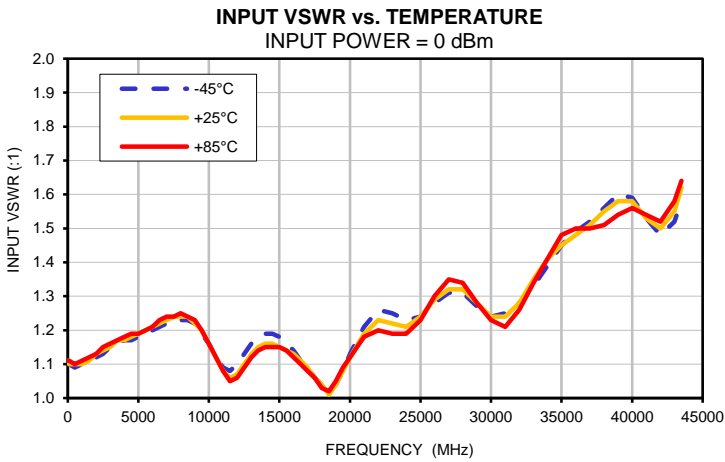
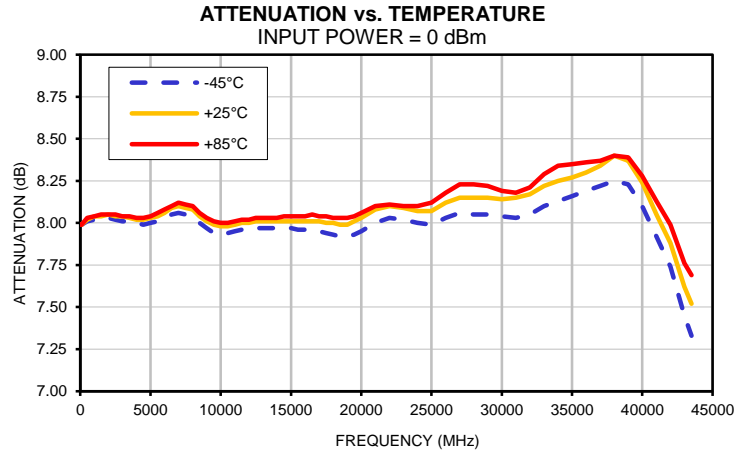

### Outline Dimensions

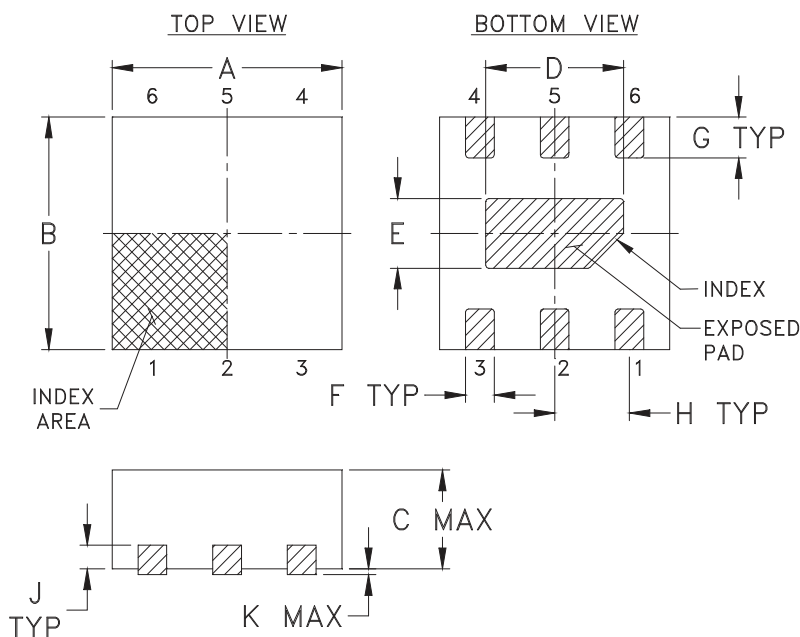

### PCB Land Pattern

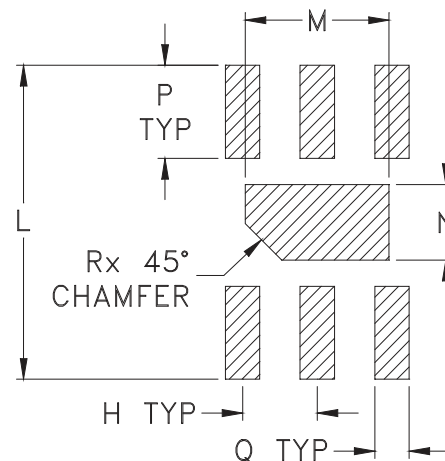

Suggested Layout,  
Tolerance to be within  $\pm .002$

CASE #.	A	B	C	D	E	F	G	H	J	K	L	M	N	P
MC1630-1	.079 (2.00)	.079 (2.00)	.039 (1.00)	.047 (1.20)	.024 (.60)	.010 (.25)	.014 (.35)	.026 (.65)	.008 (.20)	.002 (.05)	.106 (2.70)	.049 (1.25)	.026 (.65)	.031 (.80)

CASE #.	Q	R	WT, GRAM
MC1630-1	.012 (.30)	.012 (.30)	.006

Dimensions are in inches (mm). Tolerances: 2 Pl.  $\pm .01$ ; 3 Pl.  $\pm .005$

#### Notes:

- Case material: Plastic.
- Termination finish:  
For RoHS Case Styles: Tin-Silver over Nickel plated or Matte-Tin plated (See Data sheet).  
All models, (+) suffix.
- Lead #1 identifier shall be located in the cross-hatched area shown.  
Identifier may be either a molded or marked feature.



P.O. Box 350166, Brooklyn, New York 11235-0003 (718) 934-4500 Fax (718) 332-4661 For detailed performance specs & shopping online see Mini-Circuits web site



The Design Engineers Search Engine Provides ACTUAL Data Instantly From MINI-CIRCUITS At: [www.minicircuits.com](http://www.minicircuits.com)

RF/IF MICROWAVE COMPONENTS



# Tape & Reel Packaging TR-F66



Tape Width, mm	Device Cavity Pitch, mm	Reel Size, inches	Devices per Reel see note	
8	4	7	Small quantity standard	20
				50
				100
				200
				500
		7	Standard	1000, 2000, 3000

Note: Please consult individual model data sheet to determine device per reel availability.

Mini-Circuits carrier tape materials provide protection from ESD (Electro-Static Discharge) during handling and transportation. Tapes are static dissipative and comply with industry standards EIA-481/EIA-541.

Go to: [www.minicircuits.com/pages/pdfs/tape.pdf](http://www.minicircuits.com/pages/pdfs/tape.pdf)

**Mini-Circuits®**

INTERNET <http://www.minicircuits.com>

P.O. Box 350166, Brooklyn, New York 11235-0003 (718) 934-4500 Fax (718) 332-4661

Distribution Centers NORTH AMERICA 800-654-7949 • 417-335-5935 • Fax 417-335-5945 • EUROPE 44-1252-832600 • Fax 44-1252-837010

Mini-Circuits ISO 9001 & ISO 14001 Certified

THIRD ANGLE PROJECTION



REVISIONS

REV	ECN No.	DESCRIPTION	DATE	DR	AUTH
OR	M167874	NEW RELEASE	05/17/18	ITG	RS

SUGGESTED MOUNTING CONFIGURATION  
FOR MC1630-1 CASE STYLE, "06AF04" PIN CODE



NOTES:

- TRACE WIDTH & GAP PARAMETERS ARE SHOWN FOR ROGERS R04350B WITH DIELECTRIC THICKNESS  $.0066 \pm .0007$ . COPPER: 1/2 OZ. EACH SIDE. FOR OTHER MATERIALS TRACE WIDTH & GAP MAY NEED TO BE MODIFIED.
- BOTTOM SIDE OF THE PCB IS CONTINUOUS GROUND PLANE.

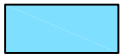

DENOTES PCB COPPER LAYOUT WITH SMOBC (SOLDER MASK OVER BARE COPPER).

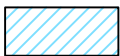

DENOTES COPPER LAND PATTERN FREE OF SOLDER MASK.

UNLESS OTHERWISE SPECIFIED	INITIALS		DATE
DIMENSIONS ARE IN INCHES TOLERANCES ON: 2 PL DECIMALS $\pm$ 3 PL DECIMALS $\pm$ .005 ANGLES $\pm$ FRACTIONS $\pm$	DRAWN	ITG	05/11/18
	CHECKED	GF	05/17/18
	APPROVED	RS	05/17/18



**Mini-Circuits®**

13 Neptune Avenue  
 Brooklyn NY 11235

PL, 06AF04, MC1630-1, TB-934-NC+

Mini-Circuits®  
 THIS DOCUMENT AND ITS CONTENTS ARE THE PROPERTY OF MINI-CIRCUITS. EXCEPT FOR USE EXPRESSLY GRANTED, IN WRITING, TO ITS VENDORS, VENDEE AND THE UNITED STATES GOVERNMENT, MINI-CIRCUITS RESERVES ALL PROPRIETARY DESIGN, USE, MANUFACTURING AND REPRODUCTION RIGHTS THERETO. THESE CONTENTS SHALL NOT BE USED, DUPLICATED OR DISCLOSED TO ANY OUTSIDE PARTY, IN WHOLE OR IN PART, WITHOUT WRITTEN PERMISSION OF MINI-CIRCUITS.

ASHEETA1.DWG REV:A DATE:01/12/95

SIZE	CODE IDENT	DRAWING NO:	REV:
A	15542	98-PL-586	OR
FILE:	98PL586	SCALE: 15:1	SHEET: 1 OF 1

# Evaluation Board and Circuit

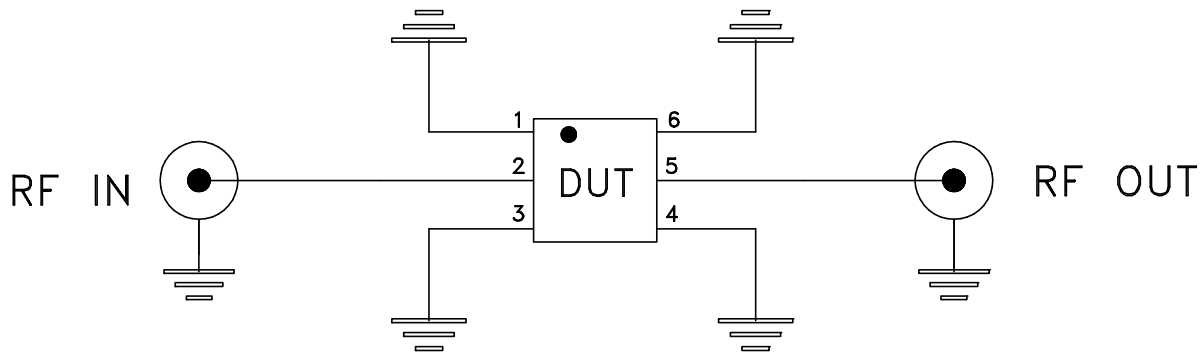
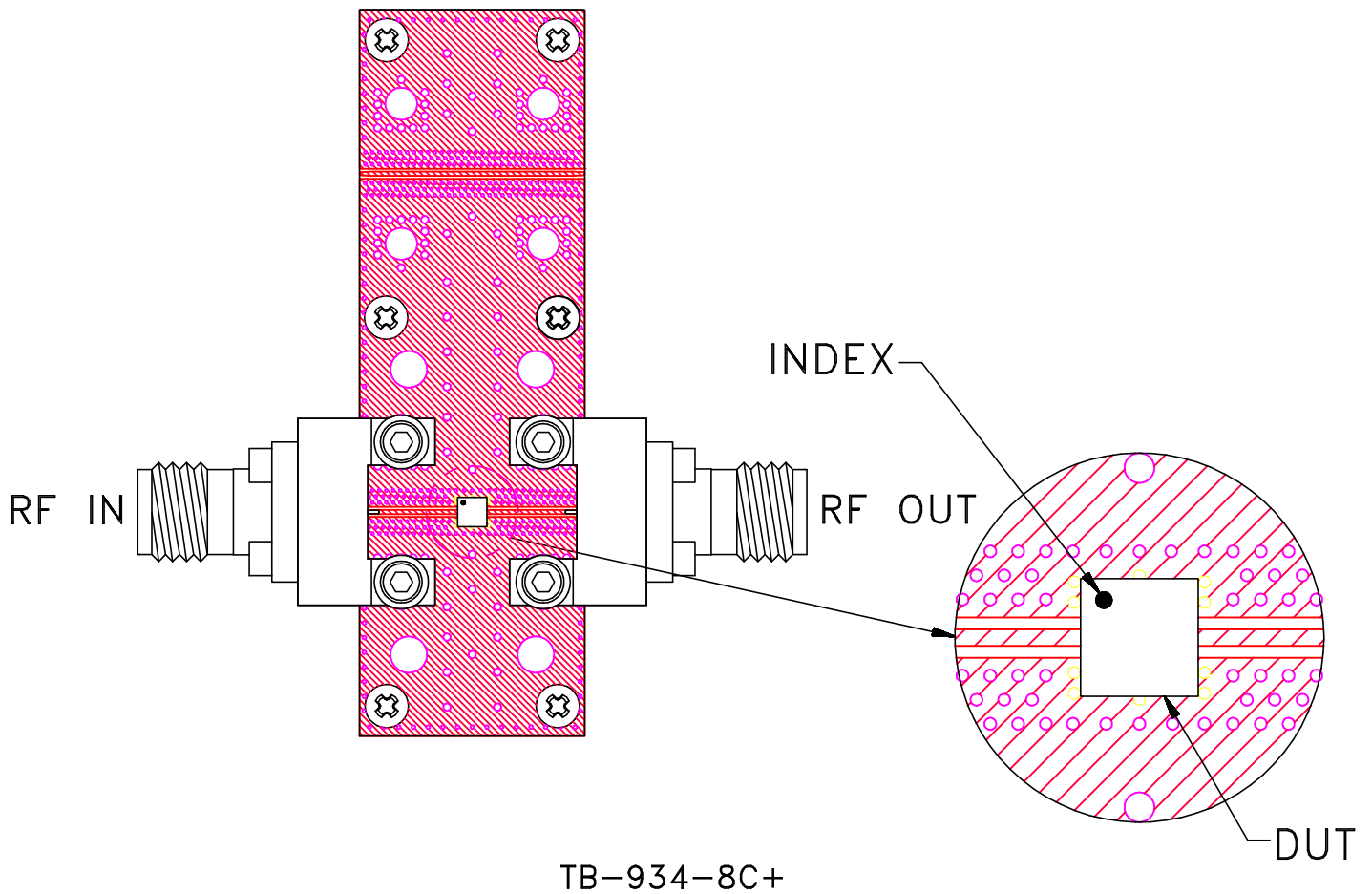

Schematic Diagram

## Notes:

1. 50 Ohm 2.40mm Female end launch connectors.
2. PCB Material: R04350 or equivalent,  
Dielectric Constant=3.5, Thickness=.0066 inch.

 **Mini-Circuits®**

All Mini-Circuits products are manufactured under exacting quality assurance and control standards, and are capable of meeting published specifications after being subjected to any or all of the following physical and environmental test.

Specification	Test/Inspection Condition	Reference/Spec
Operating Temperature	-40° to 85°C or -45° to 85°C Ambient Environment	Individual Model Data Sheet
Storage Temperature	-55° to 100° C or -65° to 150° Ambient Environment	Individual Model Data Sheet
Thermal Shock	-55° to 100°C, 100 cycles	MIL-STD-202, Method 107, Condition A-3, except +100°C
Mechanical Shock	1.5Kg, 0.5 ms, 5 shock pulses, Y1 direction only	MIL-STD-883, Method 2002, Condition B, except Y1 direction only
Vibration (Variable Frequency)	50g peak	MIL-STD-883, Method 2007, Condition B
Autoclave	15 psig, 100% RH, 121°C, 96 hours	JESD22-A102, Condition C
HAST	130°C, 85% RH, 96 hours	JESD22-A110
Solderability	10X Magnification	J-STD-002, Para 4.2.5, Test S, 95% Coverage
Solder Reflow Heat	Sn-Pb Eutetic Process: 240°C peak Pb-Free Process: 260°C peak	J-STD-020, Table 4-1, 4-2 and 5-2; Figure 5-1
Moisture Sensitivity: Level 1	Bake at 125°C for 24 hours Soak at 85°C/85% RH for 168 hours, Reflow 3 cycles at 260°C peak	J-STD-020
Marking Resistance to Solvents	Isopropyl alcohol + mineral spirits at 25°C; terpene defluxer at 25°C; distilled water + proylene glycol monomethyl ether +	MIL-STD-202, Method 215



All Mini-Circuits products are manufactured under exacting quality assurance and control standards, and are capable of meeting published specifications after being subjected to any or all of the following physical and environmental test.

<b>Specification</b>	<b>Test/Inspection Condition</b>	<b>Reference/Spec</b>
	monoethanolamine at 63°C to 70°C	