



MICROWAVE PRECISION

Fixed Attenuator

KAT-0+

50Ω 2W 0dB DC to 43.5 GHz

THE BIG DEAL

- Super bandwidth, DC to 43.5 GHz
- High Power Handling, 2W
- Small Size, 2 mm x 2 mm
- Excellent VSWR, 1.3:1 typ.



Generic photo used for illustration purposes only

CASE STYLE: MC1630-1

+RoHS Compliant

The +Suffix identifies RoHS Compliance. See our website for methodologies and qualifications

APPLICATIONS

- 5G
- Test and Measurement
- Radar
- Communication
- Defense

PRODUCT OVERVIEW

KAT-0+ is an absorptive fixed attenuator fabricated using highly reliable and repeatable GaAs MMIC IPD* process. The model operates from DC to 43.5GHz. It achieves outstanding attenuation accuracy and flatness while maintains excellent VSWR throughout the entire band. The model can also handle input power up to 2W, which makes it an ideal choice for a wide range of applications.

KEY FEATURES

| Feature | Advantages |
|---|---|
| Wideband operation, From DC to 43.5 GHz | Supports a wide array of applications including 5G, wireless infrastructure, microwave communications, satellite, defense and aerospace, medical broadband and optic applications. |
| Small Size and simple to use (2 mm x 2 mm) | As a single chip solution, the KAT series occupies less board space than a lumped element approach, minimizes component count and ensures repeatable performance over wide frequency range. |
| Wide range of nominal attenuation values (0,1,2,3,4,5,6,7,8,9,10,12,15,20 & 30) | Small increment offering enables circuit designer to change attenuation values without motherboard redesign making the KAT series ideal for select at test application. |
| MCLP™ Package | Low Inductance, repeatable transitions, excellent thermal path make the KAT series an ideal solution as an alternative to "do it yourself" lumped element-based approach. |

* IPD - Integrated Passive Device.

REV. B
ECO-014625
KAT-0+
MCL NY
220818





MICROWAVE PRECISION

Fixed Attenuator

KAT-0+

Mini-Circuits

50Ω 2W 0dB DC to 43.5 GHz

ELECTRICAL SPECIFICATIONS¹ AT 25°C, 50Ω, UNLESS NOTED OTHERWISE

| Parameter | Condition (GHz) | Min. | Typ. | Max. | Unit |
|-----------------|-----------------|------|------|------|------|
| Frequency Range | | DC | – | 43.5 | GHz |
| Attenuation | 0.01 - 5 | – | 0.02 | 0.4 | dB |
| | 5 - 10 | – | 0.03 | 0.4 | |
| | 10 - 20 | – | 0.17 | 1.0 | |
| | 20 - 30 | – | 0.39 | – | |
| | 30 - 40 | – | 0.35 | – | |
| | 40 - 43.5 | – | 0.65 | – | |
| VSWR | 0.01 - 5 | – | 1.06 | 1.3 | :1 |
| | 5 - 10 | – | 1.08 | 1.6 | |
| | 10 - 20 | – | 1.30 | 2.1 | |
| | 20 - 30 | – | 1.54 | – | |
| | 30 - 40 | – | 1.34 | – | |
| | 40 - 43.5 | – | 1.71 | – | |

1. Tested on Mini-Circuits test board TB-934-0C+. See Characterization/Application Circuit in Fig. 1

MAXIMUM RATINGS²

| Parameter | Ratings |
|-----------------------------|----------------|
| Operating Case Temperature | -40°C to 85°C |
| Storage Temperature | -65°C to 150°C |
| RF Input Power ³ | 2W |

2. Permanent damage may occur if any of these limits are exceeded.

3. Power rating derated to 1W at 85°C





MICROWAVE PRECISION

Fixed Attenuator

KAT-0+

50Ω 2W 0dB DC to 43.5 GHz

PAD DESCRIPTION

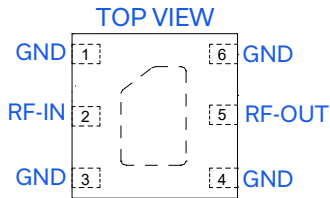

| Function | Pad Number | Description |
|----------|------------------|---------------|
| RF-IN | 2 | RF input pad |
| RF-OUT | 5 | RF output pad |
| GND | 1,3,4,6 & Paddle | Ground |

CHARACTERIZATION TEST CIRCUIT

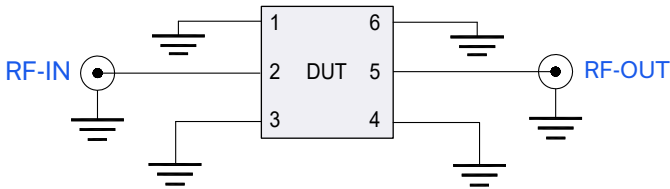
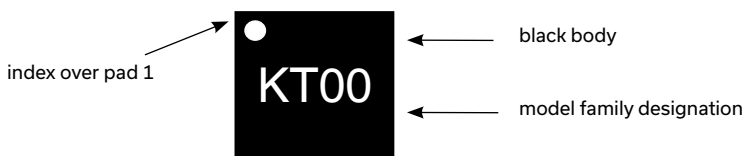

Fig 1. Block diagram of Test Circuit used for characterization, Test board TB-934-0C+ Conditions: Attenuation, VSWR: Pin=0 dBm

PRODUCT MARKING



Marking may contain other features or characters for internal lot control



MICROWAVE PRECISION

Fixed Attenuator

KAT-0+

50Ω 2W 0dB DC to 43.5 GHz

TYPICAL PERFORMANCE DATA AT 25°C

| Frequency (GHz) | Attenuation (dB) | VSWR (:1) |
|-----------------|------------------|-----------|
| 0.01 | 0.01 | 1.01 |
| 0.5 | 0.01 | 1.05 |
| 1.0 | 0.00 | 1.07 |
| 3.0 | 0.03 | 1.06 |
| 5.0 | 0.05 | 1.07 |
| 7.0 | 0.01 | 1.23 |
| 10.0 | 0.04 | 1.28 |
| 12.0 | 0.01 | 1.16 |
| 15.0 | 0.02 | 1.30 |
| 20.0 | 0.12 | 1.32 |
| 25.0 | 0.24 | 1.49 |
| 30.0 | 0.16 | 1.11 |
| 35.0 | 0.25 | 1.21 |
| 37.0 | 0.35 | 1.44 |
| 43.5 | 1.34 | 2.01 |

KAT-0+
ATTENUATION

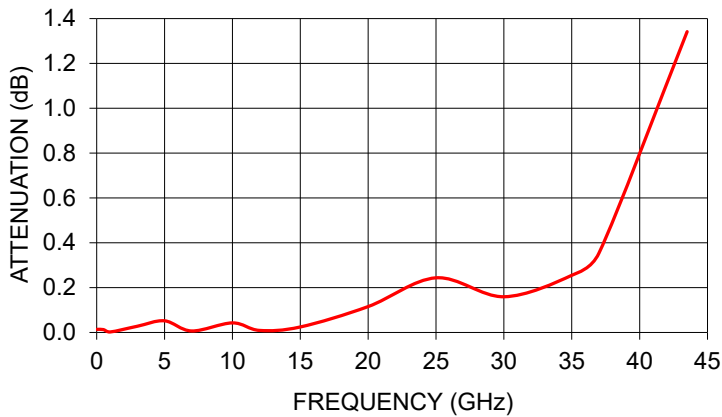

KAT-0+
VSWR

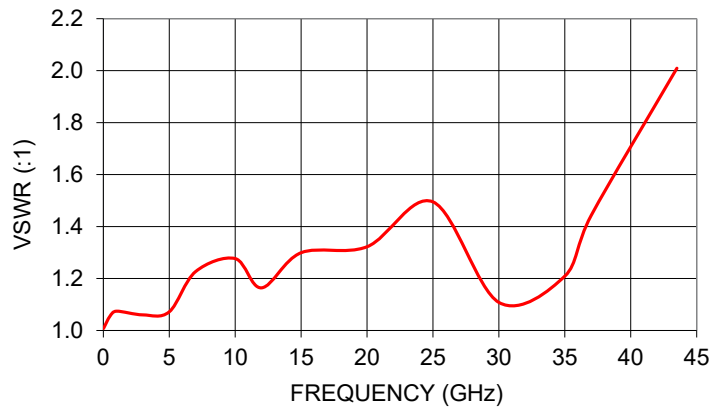



MICROWAVE PRECISION

Fixed Attenuator

KAT-0+

50Ω 2W 0dB DC to 43.5 GHz

ADDITIONAL DETAILED TECHNICAL INFORMATION IS AVAILABLE ON OUR DASH BOARD. TO ACCESS [CLICK HERE](#)

| | |
|---------------------------------------|--|
| Performance Data | Data Table Swept Graphs |
| Case Style | MC1630-1 Plastic package, Terminal finish: Matte Tin |
| Tape & Reel | F66 |
| Standard quantities available on reel | 7" reels with 20, 50, 100, 200, 500, 1K, 2K devices. |
| Suggested Layout for PCB Design | PL-586 |
| Evaluation Board | TB-934-0C+ |
| Environmental Ratings | ENV08T1 |

ESD RATING

Human Body Model (HBM): Class 2 (Pass 2000V) per ANSI/ESD STM 5.1 - 2001

NOTES

- A. Performance and quality attributes and conditions not expressly stated in this specification document are intended to be excluded and do not form a part of this specification document.
- B. Electrical specifications and performance data contained in this specification document are based on Mini-Circuit's applicable established test performance criteria and measurement instructions.
- C. The parts covered by this specification document are subject to Mini-Circuits standard limited warranty and terms and conditions (collectively, "Standard Terms"); Purchasers of this part are entitled to the rights and benefits contained therein. For a full statement of the standard terms and the exclusive rights and remedies thereunder, please visit Mini-Circuits' website at www.minicircuits.com/terms/viewterm.html



Typical Performance Data

| FREQ. | ATTENUATION | | | INPUT VSWR | | | OUTPUT VSWR | | |
|-------|-------------|--------|-------|------------|--------|-------|-------------|--------|-------|
| | (dB) | | | (:1) | | | (:1) | | |
| | (MHz) | @-45°C | @25°C | @+85°C | @-45°C | @25°C | @+85°C | @-45°C | @25°C |
| 10 | 0.00 | 0.01 | 0.01 | 1.01 | 1.01 | 1.01 | 1.01 | 1.00 | 1.00 |
| 50 | 0.00 | 0.01 | 0.01 | 1.00 | 1.01 | 1.01 | 1.00 | 1.01 | 1.01 |
| 100 | 0.01 | 0.01 | 0.01 | 1.01 | 1.02 | 1.02 | 1.01 | 1.01 | 1.01 |
| 500 | 0.03 | 0.02 | 0.03 | 1.03 | 1.04 | 1.04 | 1.03 | 1.04 | 1.04 |
| 1000 | 0.03 | 0.03 | 0.05 | 1.06 | 1.07 | 1.07 | 1.06 | 1.07 | 1.07 |
| 1500 | 0.03 | 0.04 | 0.06 | 1.10 | 1.10 | 1.10 | 1.09 | 1.10 | 1.10 |
| 2000 | 0.04 | 0.04 | 0.07 | 1.12 | 1.12 | 1.12 | 1.12 | 1.12 | 1.12 |
| 2500 | 0.04 | 0.04 | 0.07 | 1.13 | 1.12 | 1.12 | 1.13 | 1.12 | 1.12 |
| 3000 | 0.05 | 0.04 | 0.07 | 1.11 | 1.10 | 1.10 | 1.11 | 1.11 | 1.10 |
| 3500 | 0.06 | 0.04 | 0.07 | 1.08 | 1.07 | 1.07 | 1.08 | 1.07 | 1.07 |
| 4000 | 0.06 | 0.04 | 0.08 | 1.03 | 1.03 | 1.03 | 1.02 | 1.03 | 1.03 |
| 4500 | 0.06 | 0.05 | 0.08 | 1.06 | 1.04 | 1.03 | 1.05 | 1.03 | 1.03 |
| 5000 | 0.06 | 0.05 | 0.09 | 1.12 | 1.09 | 1.08 | 1.11 | 1.08 | 1.07 |
| 5500 | 0.06 | 0.05 | 0.09 | 1.15 | 1.12 | 1.11 | 1.15 | 1.12 | 1.11 |
| 6000 | 0.07 | 0.05 | 0.09 | 1.15 | 1.14 | 1.13 | 1.15 | 1.14 | 1.13 |
| 6500 | 0.08 | 0.05 | 0.09 | 1.13 | 1.13 | 1.12 | 1.13 | 1.14 | 1.13 |
| 7000 | 0.09 | 0.05 | 0.10 | 1.10 | 1.11 | 1.10 | 1.10 | 1.11 | 1.11 |
| 7500 | 0.10 | 0.04 | 0.10 | 1.06 | 1.07 | 1.07 | 1.07 | 1.08 | 1.08 |
| 8000 | 0.11 | 0.04 | 0.09 | 1.04 | 1.05 | 1.05 | 1.05 | 1.06 | 1.06 |
| 8500 | 0.12 | 0.04 | 0.09 | 1.04 | 1.05 | 1.05 | 1.05 | 1.05 | 1.05 |
| 9000 | 0.12 | 0.04 | 0.09 | 1.05 | 1.06 | 1.06 | 1.06 | 1.06 | 1.07 |
| 9500 | 0.12 | 0.04 | 0.10 | 1.07 | 1.08 | 1.09 | 1.07 | 1.08 | 1.09 |
| 10000 | 0.12 | 0.05 | 0.11 | 1.11 | 1.12 | 1.12 | 1.11 | 1.11 | 1.12 |
| 10500 | 0.11 | 0.07 | 0.13 | 1.17 | 1.17 | 1.17 | 1.16 | 1.16 | 1.16 |
| 11000 | 0.08 | 0.09 | 0.15 | 1.24 | 1.22 | 1.22 | 1.23 | 1.21 | 1.21 |
| 11500 | 0.06 | 0.11 | 0.17 | 1.29 | 1.26 | 1.25 | 1.29 | 1.26 | 1.24 |
| 12000 | 0.05 | 0.12 | 0.19 | 1.33 | 1.28 | 1.27 | 1.32 | 1.28 | 1.26 |
| 12500 | 0.05 | 0.12 | 0.19 | 1.34 | 1.29 | 1.27 | 1.34 | 1.29 | 1.27 |
| 13000 | 0.06 | 0.12 | 0.19 | 1.32 | 1.28 | 1.25 | 1.33 | 1.29 | 1.26 |
| 13500 | 0.08 | 0.12 | 0.18 | 1.29 | 1.26 | 1.23 | 1.31 | 1.28 | 1.24 |
| 14000 | 0.09 | 0.11 | 0.18 | 1.27 | 1.25 | 1.22 | 1.29 | 1.26 | 1.23 |
| 14500 | 0.10 | 0.10 | 0.18 | 1.26 | 1.25 | 1.22 | 1.28 | 1.26 | 1.23 |
| 15000 | 0.10 | 0.10 | 0.18 | 1.28 | 1.26 | 1.24 | 1.28 | 1.26 | 1.24 |
| 15500 | 0.11 | 0.11 | 0.20 | 1.29 | 1.28 | 1.27 | 1.29 | 1.28 | 1.27 |
| 16000 | 0.10 | 0.13 | 0.22 | 1.32 | 1.31 | 1.30 | 1.32 | 1.30 | 1.30 |
| 16500 | 0.08 | 0.15 | 0.25 | 1.35 | 1.35 | 1.36 | 1.34 | 1.34 | 1.34 |
| 17000 | 0.05 | 0.19 | 0.31 | 1.40 | 1.40 | 1.42 | 1.39 | 1.39 | 1.40 |
| 17500 | 0.02 | 0.24 | 0.37 | 1.46 | 1.47 | 1.49 | 1.45 | 1.45 | 1.47 |
| 18000 | 0.03 | 0.30 | 0.44 | 1.53 | 1.54 | 1.57 | 1.52 | 1.53 | 1.55 |
| 18500 | 0.09 | 0.38 | 0.52 | 1.61 | 1.62 | 1.65 | 1.60 | 1.61 | 1.63 |
| 19000 | 0.17 | 0.46 | 0.60 | 1.70 | 1.70 | 1.72 | 1.69 | 1.70 | 1.71 |
| 19500 | 0.25 | 0.55 | 0.67 | 1.78 | 1.78 | 1.79 | 1.78 | 1.79 | 1.78 |
| 20000 | 0.32 | 0.61 | 0.72 | 1.85 | 1.84 | 1.83 | 1.87 | 1.86 | 1.83 |
| 21000 | 0.41 | 0.61 | 0.69 | 1.97 | 1.86 | 1.79 | 2.00 | 1.89 | 1.81 |
| 22000 | 0.31 | 0.47 | 0.54 | 1.90 | 1.72 | 1.64 | 1.93 | 1.74 | 1.65 |
| 23000 | 0.03 | 0.30 | 0.41 | 1.58 | 1.52 | 1.47 | 1.58 | 1.52 | 1.47 |
| 24000 | 0.13 | 0.22 | 0.36 | 1.33 | 1.40 | 1.39 | 1.32 | 1.39 | 1.38 |
| 25000 | 0.09 | 0.24 | 0.40 | 1.43 | 1.44 | 1.45 | 1.43 | 1.42 | 1.43 |
| 26000 | 0.10 | 0.35 | 0.53 | 1.73 | 1.59 | 1.61 | 1.72 | 1.58 | 1.59 |
| 27000 | 0.15 | 0.47 | 0.65 | 1.78 | 1.71 | 1.73 | 1.75 | 1.71 | 1.73 |
| 28000 | 0.05 | 0.47 | 0.64 | 1.61 | 1.68 | 1.67 | 1.61 | 1.69 | 1.68 |
| 29000 | 0.02 | 0.39 | 0.53 | 1.55 | 1.55 | 1.51 | 1.59 | 1.57 | 1.51 |
| 30000 | 0.06 | 0.34 | 0.47 | 1.61 | 1.47 | 1.41 | 1.64 | 1.50 | 1.43 |
| 31000 | 0.01 | 0.34 | 0.49 | 1.57 | 1.49 | 1.45 | 1.57 | 1.51 | 1.47 |
| 32000 | 0.10 | 0.33 | 0.51 | 1.48 | 1.52 | 1.52 | 1.48 | 1.51 | 1.51 |
| 33000 | 0.15 | 0.22 | 0.41 | 1.49 | 1.44 | 1.45 | 1.48 | 1.41 | 1.39 |
| 34000 | 0.29 | 0.08 | 0.28 | 1.38 | 1.29 | 1.30 | 1.30 | 1.20 | 1.18 |
| 35000 | 0.35 | 0.07 | 0.29 | 1.29 | 1.29 | 1.33 | 1.18 | 1.21 | 1.23 |
| 36000 | 0.17 | 0.23 | 0.46 | 1.52 | 1.47 | 1.51 | 1.52 | 1.45 | 1.47 |
| 37000 | 0.11 | 0.39 | 0.63 | 1.50 | 1.58 | 1.60 | 1.55 | 1.60 | 1.61 |
| 38000 | 0.13 | 0.41 | 0.63 | 1.50 | 1.55 | 1.53 | 1.48 | 1.59 | 1.57 |
| 39000 | 0.07 | 0.32 | 0.51 | 1.61 | 1.42 | 1.35 | 1.61 | 1.47 | 1.41 |
| 40000 | 0.12 | 0.23 | 0.44 | 1.52 | 1.36 | 1.30 | 1.61 | 1.39 | 1.32 |
| 41000 | 0.24 | 0.27 | 0.51 | 1.35 | 1.41 | 1.42 | 1.44 | 1.41 | 1.37 |
| 42000 | 0.08 | 0.55 | 0.87 | 1.51 | 1.60 | 1.66 | 1.38 | 1.53 | 1.57 |
| 43000 | 0.59 | 1.13 | 1.53 | 2.10 | 2.00 | 2.09 | 1.91 | 1.88 | 1.96 |
| 43500 | 1.09 | 1.49 | 1.90 | 2.55 | 2.26 | 2.33 | 2.41 | 2.15 | 2.19 |



Typical Performance Curves

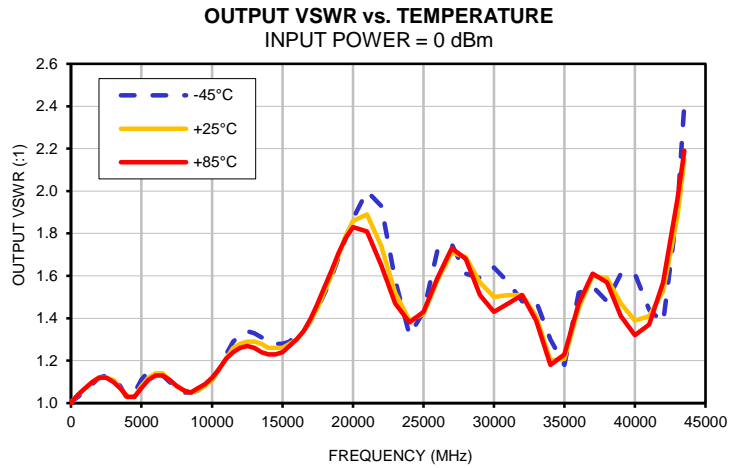
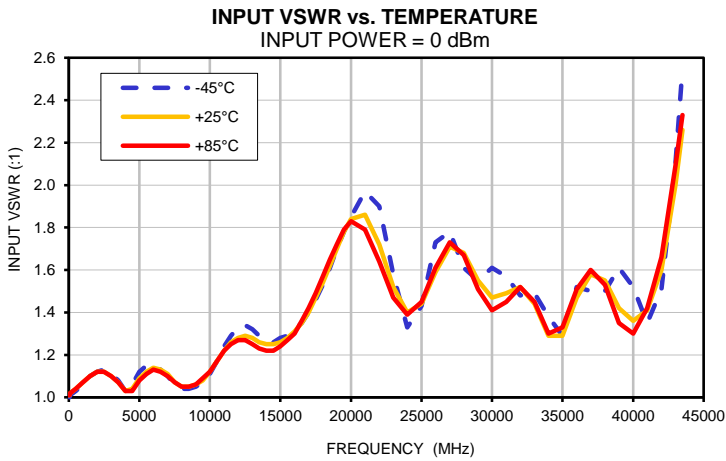
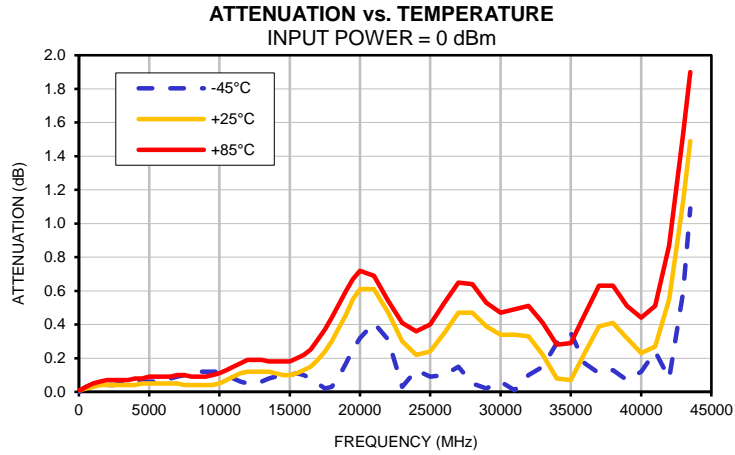

Outline Dimensions

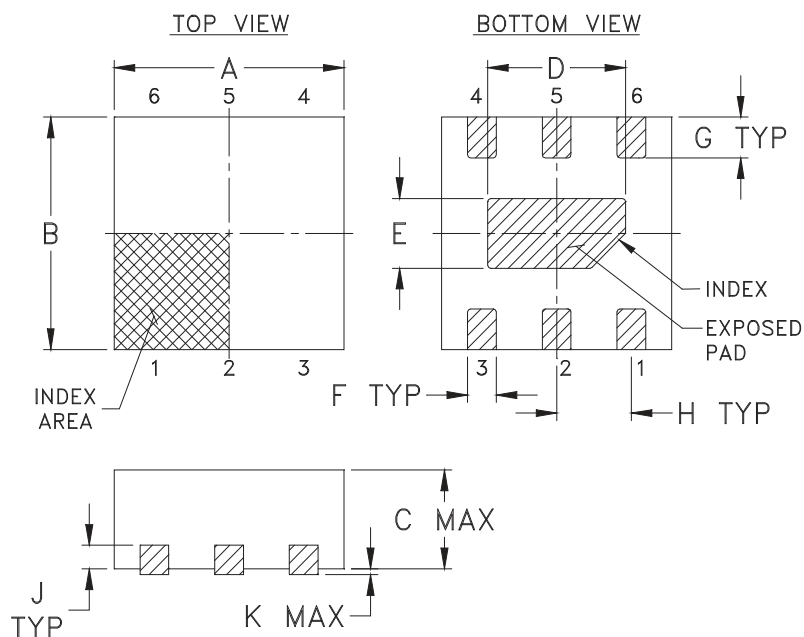

PCB Land Pattern

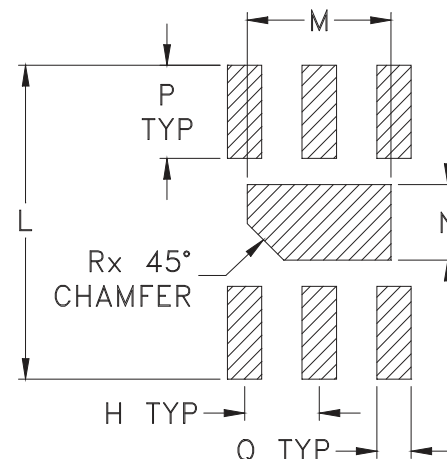

Suggested Layout,
Tolerance to be within $\pm .002$

| CASE #. | A | B | C | D | E | F | G | H | J | K | L | M | N | P |
|----------|----------------|----------------|----------------|----------------|---------------|---------------|---------------|---------------|---------------|---------------|----------------|----------------|---------------|---------------|
| MC1630-1 | .079 (2.00) | .079 (2.00) | .039 (1.00) | .047 (1.20) | .024 (.60) | .010 (.25) | .014 (.35) | .026 (.65) | .008 (.20) | .002 (.05) | .106 (2.70) | .049 (1.25) | .026 (.65) | .031 (.80) |

| CASE #. | Q | R | WT, GRAM |
|----------|---------------|---------------|----------|
| MC1630-1 | .012 (.30) | .012 (.30) | .006 |

Dimensions are in inches (mm). Tolerances: 2 Pl. $\pm .01$; 3 Pl. $\pm .005$

Notes:

- Case material: Plastic.
- Termination finish:
For RoHS Case Styles: Tin-Silver over Nickel plated or Matte-Tin plated (See Data sheet).
All models, (+) suffix.
- Lead #1 identifier shall be located in the cross-hatched area shown.
Identifier may be either a molded or marked feature.



P.O. Box 350166, Brooklyn, New York 11235-0003 (718) 934-4500 Fax (718) 332-4661 For detailed performance specs & shopping online see Mini-Circuits web site



The Design Engineers Search Engine Provides ACTUAL Data Instantly From MINI-CIRCUITS At: www.minicircuits.com

RF/IF MICROWAVE COMPONENTS

Tape & Reel Packaging TR-F66



| Tape Width, mm | Device Cavity Pitch, mm | Reel Size, inches | Devices per Reel see note | |
|----------------|-------------------------|-------------------|------------------------------|------------------|
| 8 | 4 | 7 | Small quantity standard | 20 |
| | | | | 50 |
| | | | | 100 |
| | | | | 200 |
| | | | | 500 |
| | | 7 | Standard | 1000, 2000, 3000 |

Note: Please consult individual model data sheet to determine device per reel availability.

Mini-Circuits carrier tape materials provide protection from ESD (Electro-Static Discharge) during handling and transportation. Tapes are static dissipative and comply with industry standards EIA-481/EIA-541.

Go to: www.minicircuits.com/pages/pdfs/tape.pdf

Mini-Circuits®

INTERNET <http://www.minicircuits.com>

P.O. Box 350166, Brooklyn, New York 11235-0003 (718) 934-4500 Fax (718) 332-4661

Distribution Centers NORTH AMERICA 800-654-7949 • 417-335-5935 • Fax 417-335-5945 • EUROPE 44-1252-832600 • Fax 44-1252-837010

Mini-Circuits ISO 9001 & ISO 14001 Certified

THIRD ANGLE PROJECTION



REVISIONS

| REV | ECN No. | DESCRIPTION | DATE | DR | AUTH |
|-----|---------|-------------|----------|-----|------|
| OR | M167874 | NEW RELEASE | 05/17/18 | ITG | RS |
| | | | | | |
| | | | | | |

SUGGESTED MOUNTING CONFIGURATION
FOR MC1630-1 CASE STYLE, "06AF04" PIN CODE



NOTES:

- TRACE WIDTH & GAP PARAMETERS ARE SHOWN FOR ROGERS R04350B WITH DIELECTRIC THICKNESS $.0066 \pm .0007$. COPPER: 1/2 OZ. EACH SIDE. FOR OTHER MATERIALS TRACE WIDTH & GAP MAY NEED TO BE MODIFIED.
- BOTTOM SIDE OF THE PCB IS CONTINUOUS GROUND PLANE.

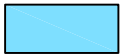

DENOTES PCB COPPER LAYOUT WITH SMOBC (SOLDER MASK OVER BARE COPPER).

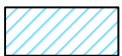

DENOTES COPPER LAND PATTERN FREE OF SOLDER MASK.

| UNLESS OTHERWISE SPECIFIED | INITIALS | DATE |
|--|----------|--------------|
| DIMENSIONS ARE IN INCHES TOLERANCES ON: 2 PL DECIMALS ± 3 PL DECIMALS ± .005 ANGLES ± FRACTIONS ± | DRAWN | ITG 05/11/18 |
| | CHECKED | GF 05/17/18 |
| | APPROVED | RS 05/17/18 |



Mini-Circuits®

13 Neptune Avenue
 Brooklyn NY 11235

PL, 06AF04, MC1630-1, TB-934-NC+

Mini-Circuits®
 THIS DOCUMENT AND ITS CONTENTS ARE THE PROPERTY OF MINI-CIRCUITS. EXCEPT FOR USE EXPRESSLY GRANTED, IN WRITING, TO ITS VENDORS, VENDEE AND THE UNITED STATES GOVERNMENT, MINI-CIRCUITS RESERVES ALL PROPRIETARY DESIGN, USE, MANUFACTURING AND REPRODUCTION RIGHTS THERETO. THESE CONTENTS SHALL NOT BE USED, DUPLICATED OR DISCLOSED TO ANY OUTSIDE PARTY, IN WHOLE OR IN PART, WITHOUT WRITTEN PERMISSION OF MINI-CIRCUITS.

| | | | |
|------------------|---------------------|--------------------------|------------|
| SIZE A | CODE IDENT 15542 | DRAWING NO: 98-PL-586 | REV: OR |
| FILE: 98PL586 | SCALE: 15:1 | SHEET: 1 OF 1 | |

Evaluation Board and Circuit

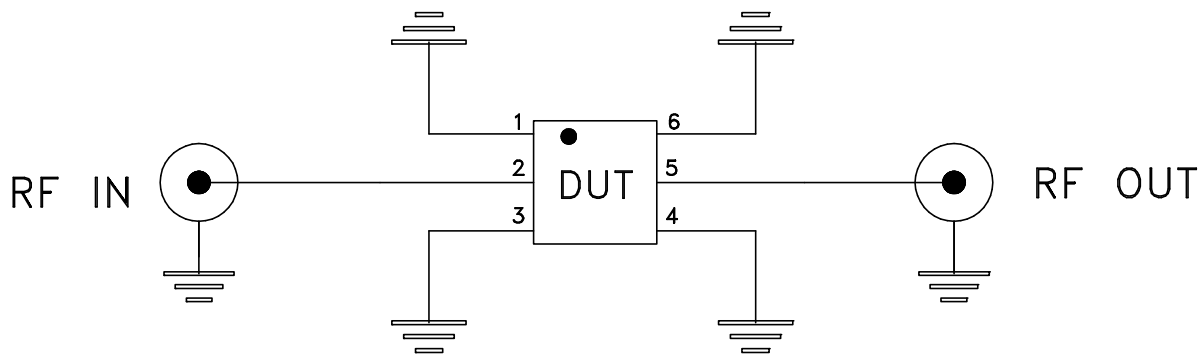
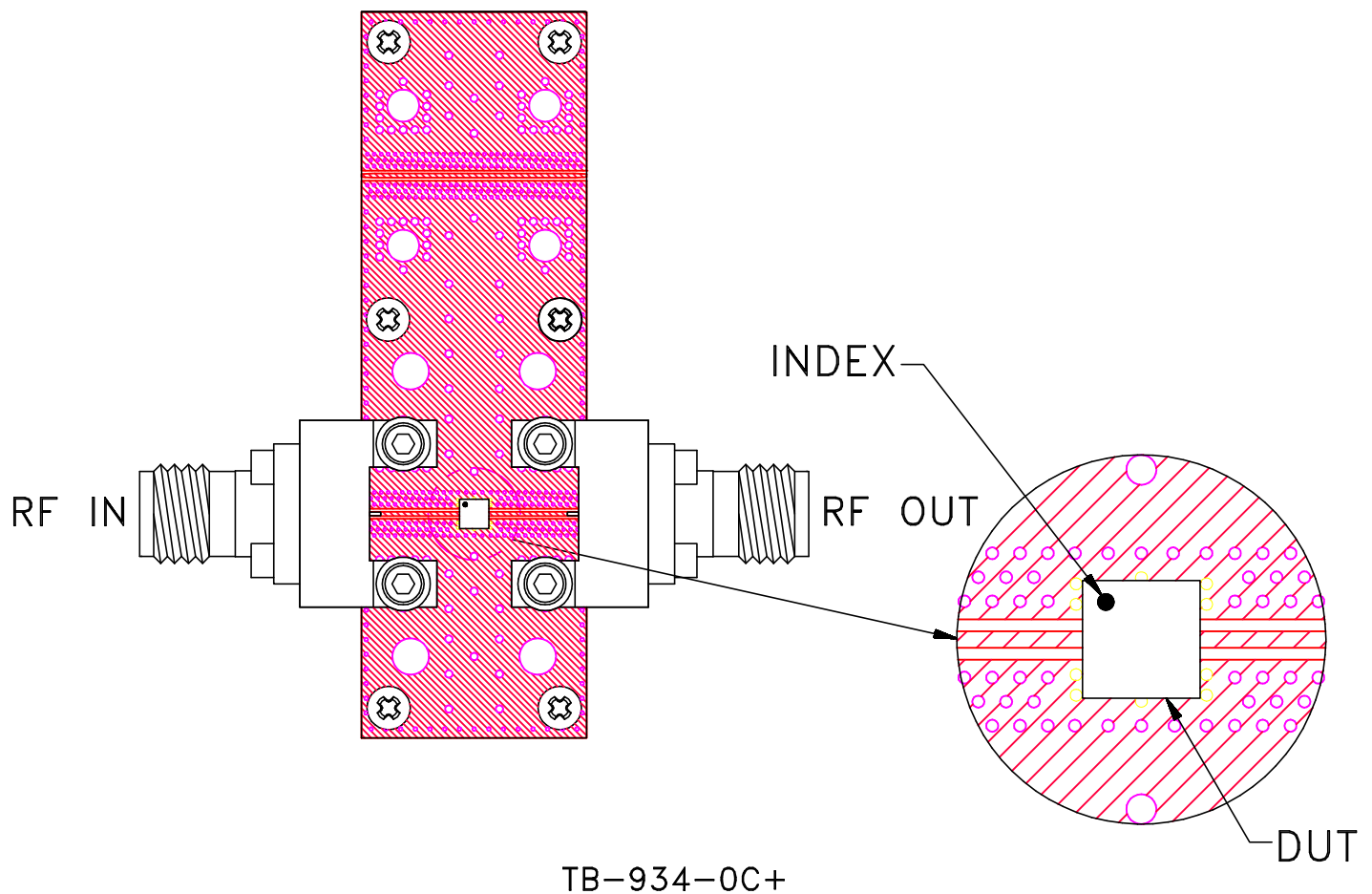

Schematic Diagram

Notes:

1. 50 Ohm 2.40mm Female end launch connectors.
2. PCB Material: R04350 or equivalent,
Dielectric Constant=3.5, Thickness=.0066 inch.

 **Mini-Circuits®**

All Mini-Circuits products are manufactured under exacting quality assurance and control standards, and are capable of meeting published specifications after being subjected to any or all of the following physical and environmental test.

| Specification | Test/Inspection Condition | Reference/Spec |
|--------------------------------|--|---|
| Operating Temperature | -40° to 85°C or -45° to 85°C Ambient Environment | Individual Model Data Sheet |
| Storage Temperature | -55° to 100° C or -65° to 150° Ambient Environment | Individual Model Data Sheet |
| Thermal Shock | -55° to 100°C, 100 cycles | MIL-STD-202, Method 107, Condition A-3, except +100°C |
| Mechanical Shock | 1.5Kg, 0.5 ms, 5 shock pulses, Y1 direction only | MIL-STD-883, Method 2002, Condition B, except Y1 direction only |
| Vibration (Variable Frequency) | 50g peak | MIL-STD-883, Method 2007, Condition B |
| Autoclave | 15 psig, 100% RH, 121°C, 96 hours | JESD22-A102, Condition C |
| HAST | 130°C, 85% RH, 96 hours | JESD22-A110 |
| Solderability | 10X Magnification | J-STD-002, Para 4.2.5, Test S, 95% Coverage |
| Solder Reflow Heat | Sn-Pb Eutetic Process: 240°C peak Pb-Free Process: 260°C peak | J-STD-020, Table 4-1, 4-2 and 5-2; Figure 5-1 |
| Moisture Sensitivity: Level 1 | Bake at 125°C for 24 hours Soak at 85°C/85% RH for 168 hours, Reflow 3 cycles at 260°C peak | J-STD-020 |
| Marking Resistance to Solvents | Isopropyl alcohol + mineral spirits at 25°C; terpene defluxer at 25°C; distilled water + proylene glycol monomethyl ether + | MIL-STD-202, Method 215 |



All Mini-Circuits products are manufactured under exacting quality assurance and control standards, and are capable of meeting published specifications after being subjected to any or all of the following physical and environmental test.

| Specification | Test/Inspection Condition | Reference/Spec |
|----------------------|----------------------------------|-----------------------|
| | monoethanolamine at 63°C to 70°C | |