

High Power SPDT RF Switch

JSW2-63VHDRP+

RF Switch with internal driver
Single Supply Voltage, +2.3V to +5.5V

The Big Deal

- High power handling, 2.5W @2 GHz
- High IIP3, +75 dBm
- Low insertion loss, 0.4 dB
- Fast switching, 2 μ s
- Tiny Size, 2x2mm



CASE STYLE: MT2140

Product Overview

Mini-Circuits' JSW2-63VHDRP+ is a reflective symmetric MMIC SPDT switch with an internal CMOS driver designed for wideband operation from 5 to 6000 MHz. This model provides power handling up to 2.5W with low insertion loss, high dynamic range, and fast switching speed in a tiny 2x2mm 12-Lead MCLP package. JSW2-63VHDRP+ operates on a single positive supply voltage with low current consumption of just 120 μ A. Produced using a Silicon-on-Insulator process, it provides a high level of ESD protection and excellent repeatability.

The switching logic for this model sets the switch from COM to RF1 with control voltage in the low state and COM to RF2 with control voltage in the high state. Alternative model (JSW2-63VHDRG+) is also available with opposite switching logic for your convenience.

Key Features

Feature	Advantages
Wideband, 5 to 6000 MHz	One model can be used in many applications, saving component count. Also ideal for wideband applications such as military and instrumentation.
High power and low loss <ul style="list-style-type: none">• 2.5W power handling @ 2 GHz• 0.4 dB insertion loss	Supports applications with a range of power requirements with excellent transmission of signal power from input to output.
High Isolation <ul style="list-style-type: none">• 68 dB at 100 MHz• 20 dB at 5000 MHz	High isolation significantly reduces leakage of power into OFF ports.
High linearity, <ul style="list-style-type: none">• +75 dBm IIP3• +115 dBm IIP2	High linearity minimizes unwanted intermodulation products which are difficult or impossible to filter in multi-carrier environments, or in the presence of strong interfering signal from adjacent circuitry or received by antenna.
Built-in CMOS driver	Eliminates the need for an external driver, saving PCB space and cost.
Tiny size, 2 x 2mm QFN package	Tiny footprint saves space in dense layouts while providing low inductance, repeatable transitions, and excellent thermal contact to the PCB.



High Power SPDT RF Switch

50Ω 5 - 6000 MHz

RF Switch with internal driver
Single Supply Voltage, +2.3V to +5.5V

Product Features

- High Power, 2.5W at 2 GHz
- Low insertion loss, 0.4 dB typ. at 3 GHz
- High IIP3, 75 dBm typ. from 100-6000 MHz
- Low current consumption, 120 μA typ.
- Immune to latch up

Typical Applications

- Defense
- Communication Infrastructure
- Test and Measurements

General Description

JSW2-63VHDRP+ is a high power reflective symmetric SPDT switch with integral CMOS driver, operates with single positive supply voltage while consuming, 120 μA typical. It has been designed for wide band operation. It is packaged in a tiny 2x2 mm, 12-lead package and is rated MSL1 and passes 1KV for ESD (HBM).



JSW2-63VHDRP+

CASE STYLE: MT2140

+RoHS Compliant

The +Suffix identifies RoHS Compliance. See our web site for RoHS Compliance methodologies and qualifications

Simplified Schematic and Pad Description

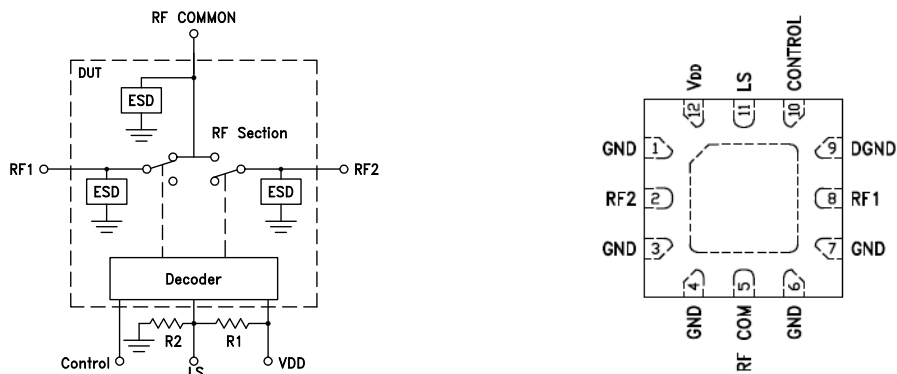

Function	Pad Number	Description
RF COM	5	RF common/ SUM port*
RF1	8	RF OUT #1 / IN port*
RF2	2	RF OUT #2 / IN port*
Control	10	CMOS Control IN
LS	11	Connect to Pad 12 via R1, connect to ground via R2
VDD	12	Supply
DGND	9	Digital Ground
GND	1,3,4,6,7, Paddle	RF Ground

*Must be held at 0Vdc. If required, add DC blocking capacitors to prevent DC on these ports.



www.minicircuits.com P.O. Box 350166, Brooklyn, NY 11235-0003 (718) 934-4500 sales@minicircuits.com

REV. A
M161454
JSW2-63VHDRP+
RS/CP
180329
Page 2 of 5

RF Electrical Specifications¹, T_{AMB}=25°C, V_{DD}= +2.3 to +5.5V, 50 Ohms

Parameter	Condition (MHz)	Min.	Typ.	Max.	Units
Frequency Range		5		6000	MHz
Insertion Loss ^{2,4} (ON STATE)	5 - 100	—	0.23	—	dB
	100 - 1000	—	0.25	0.35	
	1000 - 2000	—	0.3	0.4	
	2000 - 3000	—	0.4	0.5	
	3000 - 4000	—	0.5	0.7	
	4000 - 5000	—	0.65	0.9	
Isolation between Common Port and RF1/RF2 Ports	5 - 100	—	68	—	dB
	100 - 1000	42	44	—	
	1000 - 2000	33	35	—	
	2000 - 3000	27	29	—	
	3000 - 4000	22	24	—	
	4000 - 5000	18	20	—	
Isolation between RF1 and RF2 Ports	5 - 100	—	61	—	dB
	100 - 1000	40	41	—	
	1000 - 2000	32	33	—	
	2000 - 3000	26	28	—	
	3000 - 4000	22	24	—	
	4000 - 5000	18	20	—	
Return Loss ⁴ (ON STATE)	5 - 100		33		dB
	100 - 1000		28		
	1000 - 2000		21		
	2000 - 3000		20		
	3000 - 4000		18		
	4000 - 5000		16		
2nd Harmonic ⁵	+18 dBm Pin, 17-204 MHz		-92		dBm
	+32 dBm Pout, 850/900 MHz		-99		
	+32 dBm Pout, 1800/1900 MHz		-101		
3rd Harmonic ⁵	+18 dBm Pin, 17-204 MHz		-125		dBm
	+32 dBm Pout, 850/900 MHz		-93		
	+32 dBm Pout, 1800/1900 MHz		-87		
IIP2	5		96		dBm
	17		105		
	100 - 6000		115		
IIP3	5		75		dBm
	17		81		
	5 - 6000		75		
Input 0.1dB Compression point ³	5 - 100		33		dBm
	100 - 6000		34		
θjA			119		°C/W

Notes:

1. Tested on Mini-Circuits' test board TB-948+ (see Characterization test circuit, Fig.1).
2. Insertion loss values are de-embedded from test board loss.
3. 0.1dB compression is a linearity measure and not meant for continuous operation. See Figure 2 for max operating power.
4. Insertion loss and return loss are improved by external matching.

DC Electrical Specifications

Parameter	Min.	Typ.	Max.	Units
Supply voltage, V _{DD}	2.3	3.3	5.5	V
Supply current		120	200	μA
Control voltage Low	0	0	0.5	V
Control voltage High	1.2	1.5	3.3	V

Switching Specifications

Parameter	Condition	Min.	Typ.	Max.	Units
Switching time	50% control to 90% RF or 10% RF		2	4	μSec
Video feed-through	(control 0 to 1.5V, RF freq.=10 kHz, V _{DD} =3.3V)		26		mV _{P-P}

Absolute Maximum Ratings⁵

Parameter	Ratings
Operating temperature	-40°C to +85°C
Storage temperature	-65°C to 150°C
V _{DD} , Supply voltage	+2.3 to 5.5V
Voltage control	0V Min., 3.3 Max.
RF Input power, CW	5-100 MHz: 33 dBm 100-6000 MHz: 34 dBm

5. Operation of this device above any of these conditions may cause permanent damage.

Truth Table (State of control voltage selects the desired switch state)

State of Control Voltage	RF common to	
	RF1	RF2
High	OFF	ON
Low	ON	OFF

ON- low insertion loss state OFF- Isolation State

Characterization / Application Circuits

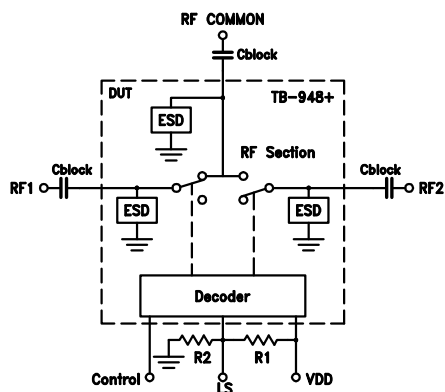

Figure 1. Block Diagram of test Circuit used for characterization (DUT, R1&R2 soldered on Mini-Circuit's TB-948+)
 R1=2.21kΩ
 R2=3.32kΩ (can be omitted if V_{DD}=2.3 to 3.3V)

Note: C_{block} is required only when DC is present on RF ports.

Power (Over-40 to 85°C) 50 Ohms

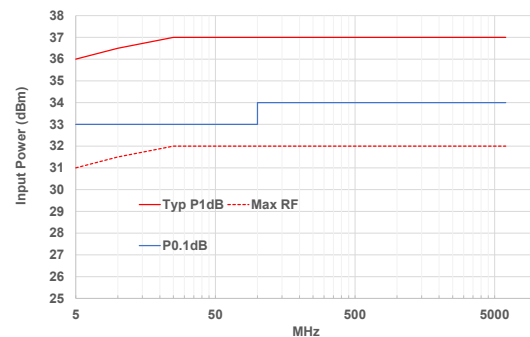
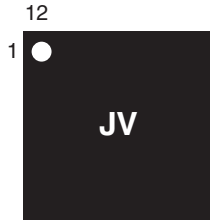

Figure 2. Max RF(operating), P_{0.1dB} (Typ) and P_{1dB} (Typ) vs frequency.

Product Marking



Additional Detailed Technical Information

additional information is available on our dash board. To access this information [click here](#)

Performance Data	Data Table
	Swept Graphs
Case Style	MT2140 <i>Plastic package, exposed paddle</i>
Tape & Reel Standard quantities available on reel	F108 <i>7" reels with 20, 50, 100, 200, 500, 1000, 3000 devices</i>
Suggested Layout for PCB Design	PL-505
Evaluation Board	TB-948+
Environmental Ratings	ENV84

ESD Rating

Human Body Model (HBM): Class 1C (pass 1000V) in accordance with MIL-STD-883, Method 3015

MSL Rating

Moisture Sensitivity: MSL1 in accordance with IPC/JEDEC J-STD-020D

Additional Notes

- A. Performance and quality attributes and conditions not expressly stated in this specification document are intended to be excluded and do not form a part of this specification document.
- B. Electrical specifications and performance data contained in this specification document are based on Mini-Circuit's applicable established test performance criteria and measurement instructions.
- C. The parts covered by this specification document are subject to Mini-Circuits standard limited warranty and terms and conditions (collectively, "Standard Terms"); Purchasers of this part are entitled to the rights and benefits contained therein. For a full statement of the Standard Terms and the exclusive rights and remedies thereunder, please visit Mini-Circuits' website at www.minicircuits.com/MCLStore/terms.jsp

Typical Performance Data

FREQ (MHz)	INSERTION LOSS @ Vdd=+3.3V OVER TEMPERATURE						FREQ (MHz)	ISOLATION @ Vdd=+3.3V OVER TEMPERATURE											
	RF COM-RF1 (dB)			RF COM-RF2 (dB)				RF COM-RF1 (dB)			RF COM-RF2 (dB)			RF1-RF2 (dB)			RF1-RF2 (dB)		
	STATE 2*			STATE 1*				STATE 1*			STATE 2*			STATE 2*			STATE 1*		
	-40°C	+25°C	+85°C	-40°C	+25°C	+85°C		-40°C	+25°C	+85°C	-40°C	+25°C	+85°C	-40°C	+25°C	+85°C	-40°C	+25°C	+85°C
5	0.21	0.24	0.27	0.23	0.27	0.31	5	86.38	81.83	80.01	92.36	84.34	85.14	79.99	79.57	81.05	80.00	79.97	75.52
10	0.21	0.24	0.27	0.23	0.27	0.31	10	86.84	86.85	84.22	86.78	87.42	85.17	81.69	80.12	79.87	80.62	80.00	80.25
100	0.20	0.24	0.27	0.23	0.27	0.31	100	69.52	67.84	66.55	69.38	67.66	66.31	61.72	60.42	60.30	62.33	61.71	61.12
200	0.19	0.24	0.28	0.22	0.27	0.32	200	63.19	61.83	60.35	63.10	61.59	60.23	55.62	54.22	54.43	56.42	55.75	55.14
300	0.19	0.24	0.29	0.22	0.27	0.33	300	59.39	57.99	56.67	59.51	57.94	56.70	52.17	50.75	50.89	52.88	52.23	51.58
400	0.19	0.25	0.29	0.22	0.28	0.33	400	56.37	55.06	53.80	56.71	55.31	53.97	49.66	48.23	48.39	50.25	49.67	49.06
500	0.18	0.25	0.30	0.22	0.28	0.34	500	54.36	52.79	51.85	54.57	53.15	51.93	47.65	46.29	46.45	48.07	47.67	46.95
600	0.18	0.26	0.31	0.21	0.29	0.35	600	51.99	50.86	49.73	52.49	51.26	50.05	46.11	44.68	44.88	46.65	46.03	45.46
700	0.18	0.26	0.31	0.22	0.29	0.36	700	50.27	49.26	48.17	50.69	49.44	48.44	44.75	43.33	43.55	45.21	44.63	44.06
800	0.18	0.27	0.32	0.22	0.30	0.37	800	48.65	47.78	46.74	49.13	48.04	47.03	43.51	42.17	42.40	43.93	43.39	42.83
900	0.18	0.27	0.33	0.22	0.30	0.38	900	47.26	46.37	45.49	47.88	46.81	45.79	42.37	41.13	41.26	42.77	42.27	41.74
1000	0.19	0.28	0.34	0.22	0.31	0.39	1000	45.87	45.14	44.27	46.53	45.60	44.67	41.41	40.14	40.33	41.70	41.23	40.72
1200	0.18	0.29	0.36	0.22	0.32	0.40	1200	43.46	42.88	42.12	44.34	43.54	42.71	39.69	38.48	38.72	39.82	39.40	38.95
1400	0.19	0.30	0.37	0.23	0.33	0.43	1400	41.32	40.83	40.20	42.32	41.65	40.88	38.08	36.99	37.17	38.13	37.75	37.37
1600	0.19	0.32	0.40	0.23	0.35	0.45	1600	39.49	39.02	38.49	40.43	40.01	39.36	36.61	35.67	35.82	36.62	36.30	35.94
1800	0.19	0.33	0.42	0.24	0.37	0.47	1800	37.72	37.39	36.92	38.71	38.37	37.89	35.30	34.42	34.63	35.24	34.90	34.57
2000	0.21	0.35	0.44	0.25	0.38	0.50	2000	36.19	35.95	35.56	37.27	36.85	36.42	34.07	33.24	33.44	33.83	33.62	33.31
2200	0.21	0.36	0.46	0.25	0.39	0.50	2200	34.74	34.53	34.23	35.78	35.58	35.13	32.91	32.24	32.36	32.64	32.44	32.22
2400	0.21	0.38	0.47	0.25	0.40	0.51	2400	33.26	33.13	32.88	34.66	34.21	34.12	31.94	31.18	31.49	31.44	31.37	31.13
2600	0.22	0.39	0.48	0.25	0.41	0.52	2600	31.95	31.78	31.60	33.27	33.16	32.97	30.83	30.26	30.46	30.49	30.33	30.17
2800	0.21	0.39	0.48	0.25	0.41	0.53	2800	30.69	30.64	30.47	32.15	31.97	31.85	29.91	29.36	29.60	29.45	29.40	29.25
3000	0.24	0.43	0.49	0.26	0.43	0.55	3000	29.57	29.55	29.36	31.09	30.94	30.62	29.06	28.55	28.58	28.43	28.42	28.22
3200	0.24	0.42	0.51	0.27	0.44	0.55	3200	28.47	28.52	28.42	29.75	29.98	29.70	28.05	27.80	27.87	27.49	27.45	27.35
3400	0.23	0.43	0.51	0.26	0.43	0.54	3400	27.53	27.49	27.45	28.73	28.91	28.60	27.13	26.91	26.92	26.52	26.53	26.44
3600	0.24	0.42	0.51	0.29	0.46	0.57	3600	26.47	26.52	26.48	28.20	28.05	27.85	26.64	26.26	26.26	25.73	25.78	25.69
3800	0.22	0.41	0.51	0.26	0.44	0.56	3800	25.51	25.54	25.56	26.89	26.86	27.13	25.56	25.20	25.64	25.00	25.03	25.06
4000	0.21	0.42	0.52	0.26	0.45	0.57	4000	24.56	24.62	24.66	26.09	26.20	26.10	24.74	24.67	24.73	24.16	24.29	24.24
4200	0.20	0.41	0.51	0.29	0.47	0.60	4200	23.79	23.88	23.91	25.23	25.18	25.10	24.22	23.95	24.10	23.43	23.55	23.50
4400	0.23	0.44	0.54	0.24	0.46	0.57	4400	23.10	23.24	23.24	24.15	24.35	24.29	23.41	23.43	23.60	22.60	22.80	22.79
4600	0.18	0.42	0.52	0.24	0.43	0.57	4600	22.38	22.49	22.62	23.19	23.37	23.35	22.61	22.67	22.75	21.85	22.08	22.13
4800	0.24	0.48	0.56	0.25	0.47	0.61	4800	21.64	21.80	21.78	22.58	22.95	22.81	22.18	22.25	22.35	21.31	21.54	21.50
5000	0.25	0.46	0.56	0.33	0.48	0.61	5000	20.86	20.93	20.95	21.76	21.98	22.11	21.20	21.44	21.68	20.57	20.85	20.93
5200	0.23	0.48	0.60	0.27	0.50	0.64	5200	19.95	20.14	20.26	21.27	21.31	21.31	21.11	20.96	21.15	20.21	20.32	20.35
5400	0.21	0.44	0.55	0.30	0.49	0.63	5400	19.28	19.40	19.53	20.62	20.50	20.50	20.40	20.29	20.40	19.30	19.50	19.51
5600	0.24	0.48	0.61	0.24	0.46	0.62	5600	18.60	18.76	18.97	19.31	19.57	19.60	19.65	19.68	19.82	18.72	18.91	18.90
5800	0.23	0.48	0.61	0.25	0.47	0.62	5800	18.11	18.31	18.42	18.59	18.94	18.93	18.89	19.12	19.25	17.92	18.18	18.28
6000	0.26	0.53	0.66	0.23	0.50	0.68	6000	17.52	17.65	17.69	18.22	18.48	18.49	18.58	18.64	18.78	17.42	17.72	17.81

STATE	CONTROL INPUT	RF Com to RF1	RF Com to RF2
1	Low	OFF	ON
2	High	ON	OFF

Typical Performance Data

FREQ (MHz)	VSWR @ Vdd=+3.3V OVER TEMPERATURE																	
	RF COM (:1) STATE 2*			RF COM (:1) STATE 1*			RF1 (:1) STATE 2*			RF1 (:1) STATE 1*			RF2 (:1) STATE 2*			RF2 (:1) STATE 1*		
	-40°C	+25°C	+85°C	-40°C	+25°C	+85°C	-40°C	+25°C	+85°C	-40°C	+25°C	+85°C	-40°C	+25°C	+85°C	-40°C	+25°C	+85°C
	5	1.04	1.05	1.05	1.04	1.05	1.05	1.04	1.05	1.05	8.90	6.90	7.03	10.23	9.06	8.06	1.04	1.04
10	1.04	1.05	1.06	1.04	1.05	1.05	1.04	1.05	1.05	8.90	6.89	7.01	10.24	9.06	8.05	1.04	1.04	1.05
100	1.05	1.05	1.06	1.05	1.05	1.06	1.05	1.05	1.05	8.73	6.79	6.93	10.04	8.89	7.95	1.05	1.05	1.05
200	1.05	1.06	1.07	1.06	1.06	1.07	1.05	1.06	1.06	8.59	6.69	6.85	9.82	8.71	7.83	1.05	1.06	1.06
300	1.06	1.07	1.07	1.06	1.06	1.07	1.05	1.07	1.08	8.51	6.61	6.71	9.61	8.50	7.60	1.06	1.07	1.08
400	1.07	1.08	1.09	1.07	1.08	1.08	1.07	1.08	1.08	8.39	6.53	6.61	9.36	8.27	7.40	1.08	1.09	1.09
500	1.08	1.09	1.11	1.08	1.09	1.11	1.08	1.09	1.09	8.24	6.43	6.54	9.15	8.08	7.28	1.09	1.10	1.10
600	1.10	1.11	1.12	1.11	1.12	1.13	1.10	1.11	1.11	8.13	6.33	6.42	9.04	7.96	7.13	1.10	1.11	1.12
700	1.12	1.13	1.13	1.13	1.14	1.14	1.12	1.12	1.13	7.97	6.23	6.29	8.92	7.87	7.01	1.12	1.13	1.14
800	1.13	1.15	1.16	1.14	1.15	1.16	1.13	1.14	1.15	7.81	6.12	6.20	8.70	7.68	6.90	1.14	1.15	1.16
900	1.15	1.17	1.18	1.16	1.17	1.19	1.15	1.16	1.17	7.73	6.01	6.08	8.44	7.44	6.69	1.16	1.17	1.18
1000	1.18	1.18	1.19	1.18	1.19	1.20	1.17	1.18	1.18	7.60	5.92	5.95	8.26	7.28	6.51	1.18	1.18	1.19
1200	1.20	1.21	1.22	1.20	1.21	1.22	1.20	1.21	1.22	7.31	5.73	5.76	8.12	7.11	6.38	1.19	1.20	1.21
1400	1.22	1.23	1.24	1.22	1.23	1.24	1.22	1.23	1.24	7.12	5.57	5.58	7.70	6.77	6.06	1.22	1.23	1.24
1600	1.26	1.26	1.27	1.26	1.27	1.27	1.25	1.26	1.27	6.91	5.40	5.38	7.63	6.65	5.93	1.25	1.26	1.26
1800	1.27	1.29	1.29	1.28	1.29	1.30	1.26	1.28	1.29	6.77	5.27	5.26	7.35	6.38	5.72	1.27	1.29	1.29
2000	1.29	1.30	1.30	1.30	1.31	1.31	1.29	1.30	1.30	6.61	5.13	5.10	7.14	6.19	5.51	1.29	1.30	1.30
2200	1.31	1.32	1.33	1.28	1.29	1.30	1.30	1.31	1.32	6.49	5.02	5.00	7.05	6.11	5.47	1.29	1.29	1.30
2400	1.31	1.31	1.31	1.27	1.28	1.28	1.31	1.31	1.31	6.36	4.90	4.89	6.82	5.87	5.26	1.28	1.28	1.28
2600	1.30	1.30	1.30	1.27	1.27	1.27	1.30	1.30	1.31	6.28	4.80	4.79	6.83	5.83	5.20	1.26	1.26	1.27
2800	1.26	1.27	1.28	1.23	1.24	1.24	1.28	1.28	1.28	6.11	4.69	4.71	6.58	5.67	5.11	1.24	1.25	1.25
3000	1.26	1.24	1.24	1.24	1.23	1.22	1.27	1.25	1.25	6.04	4.62	4.60	6.62	5.64	5.05	1.24	1.23	1.23
3200	1.21	1.21	1.21	1.19	1.19	1.19	1.23	1.22	1.23	5.99	4.57	4.55	6.55	5.57	4.99	1.22	1.21	1.22
3400	1.18	1.16	1.15	1.15	1.14	1.13	1.21	1.19	1.19	5.88	4.54	4.53	6.43	5.52	4.96	1.18	1.17	1.17
3600	1.14	1.12	1.13	1.10	1.09	1.10	1.19	1.17	1.18	5.89	4.52	4.50	6.60	5.62	5.00	1.13	1.13	1.14
3800	1.10	1.08	1.08	1.07	1.06	1.06	1.15	1.14	1.15	5.96	4.54	4.52	6.50	5.52	4.96	1.10	1.11	1.11
4000	1.06	1.04	1.05	1.08	1.06	1.07	1.15	1.13	1.14	5.86	4.56	4.53	6.58	5.65	5.04	1.10	1.10	1.11
4200	1.06	1.04	1.03	1.07	1.04	1.04	1.13	1.13	1.14	6.00	4.58	4.52	6.61	5.64	5.03	1.10	1.11	1.11
4400	1.09	1.07	1.07	1.04	1.02	1.02	1.14	1.13	1.14	5.97	4.62	4.57	6.82	5.78	5.13	1.13	1.12	1.13
4600	1.13	1.10	1.09	1.08	1.06	1.06	1.16	1.14	1.14	5.98	4.65	4.57	6.85	5.87	5.24	1.14	1.13	1.14
4800	1.14	1.13	1.13	1.10	1.10	1.10	1.15	1.14	1.15	6.10	4.69	4.61	6.97	5.86	5.21	1.14	1.14	1.15
5000	1.18	1.15	1.15	1.15	1.12	1.12	1.16	1.15	1.15	6.12	4.75	4.62	7.25	6.10	5.40	1.13	1.12	1.12
5200	1.17	1.16	1.16	1.15	1.13	1.13	1.14	1.14	1.15	6.21	4.77	4.67	7.06	6.00	5.37	1.08	1.09	1.09
5400	1.21	1.18	1.19	1.16	1.14	1.13	1.14	1.13	1.14	6.33	4.85	4.73	7.28	6.15	5.46	1.08	1.08	1.10
5600	1.22	1.20	1.21	1.13	1.12	1.11	1.14	1.12	1.14	6.22	4.83	4.73	7.30	6.17	5.53	1.08	1.07	1.08
5800	1.24	1.24	1.24	1.13	1.13	1.13	1.11	1.12	1.14	6.43	4.93	4.78	7.29	6.10	5.44	1.07	1.08	1.08
6000	1.28	1.27	1.27	1.17	1.17	1.18	1.14	1.14	1.16	6.33	4.90	4.79	7.26	6.15	5.47	1.08	1.07	1.07

*Note:

STATE	CONTROL INPUT	RF Com to RF1	RF Com to RF2
1	Low	OFF	ON
2	High	ON	OFF

Typical Performance Curves

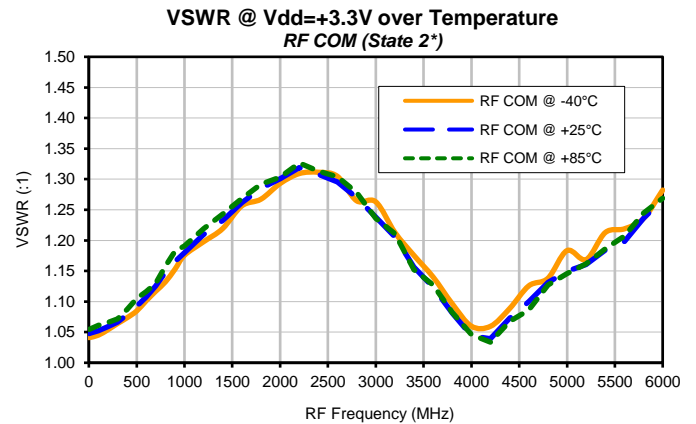
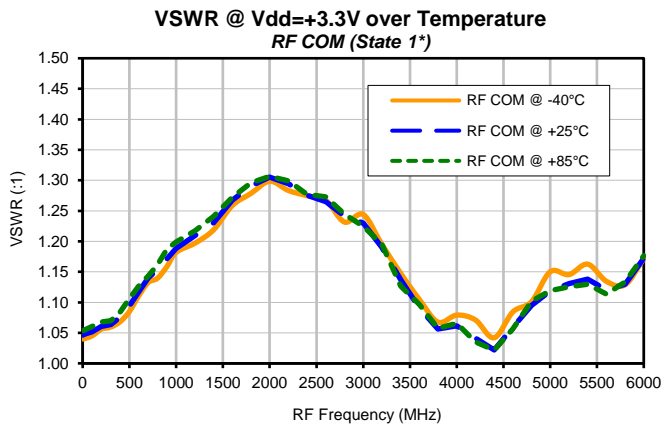
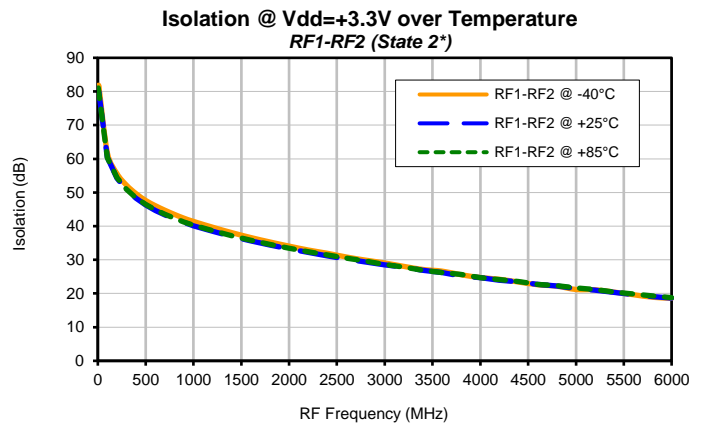
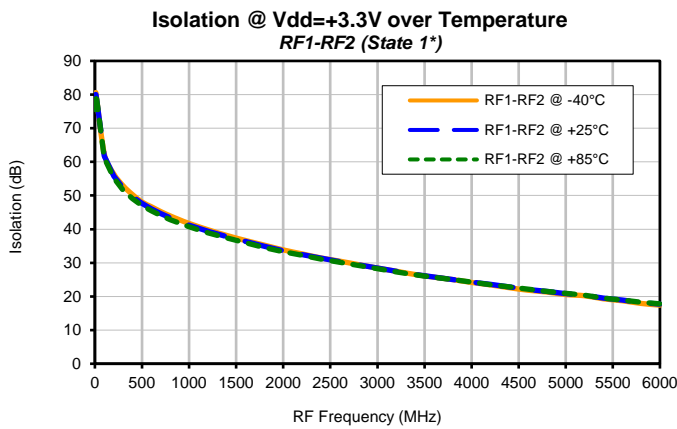
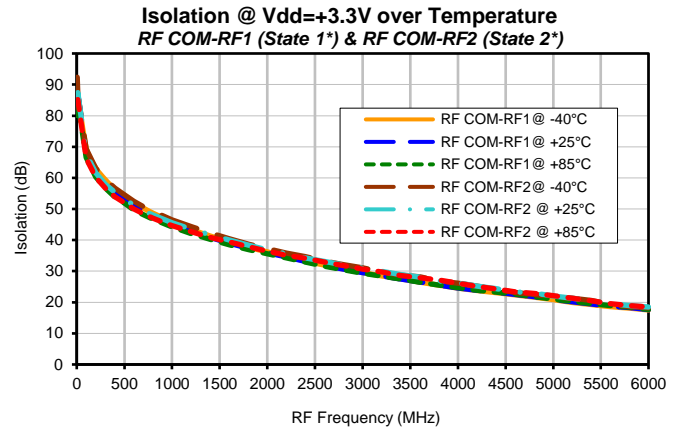
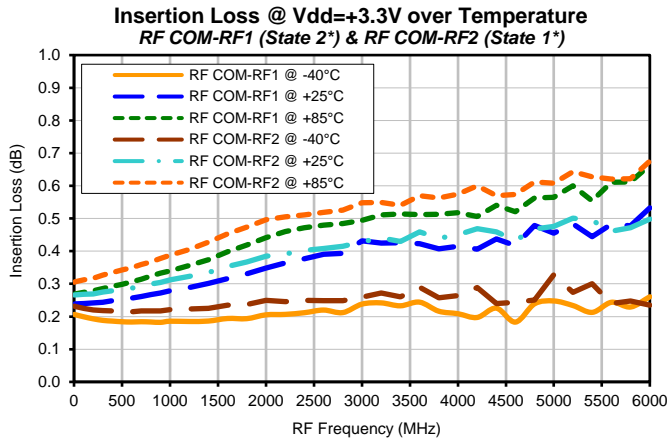

*Note:

STATE	CONTROL INPUT	RF Com to RF1	RF Com to RF2
1	Low	OFF	ON
2	High	ON	OFF

Typical Performance Curves

**VSWR @ Vdd=+3.3V over Temperature
RF1 (State 2*)**

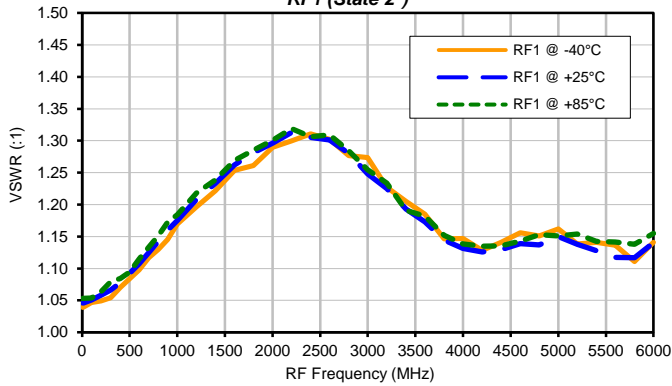

**VSWR @ Vdd=+3.3V over Temperature
RF1 (State 1*)**

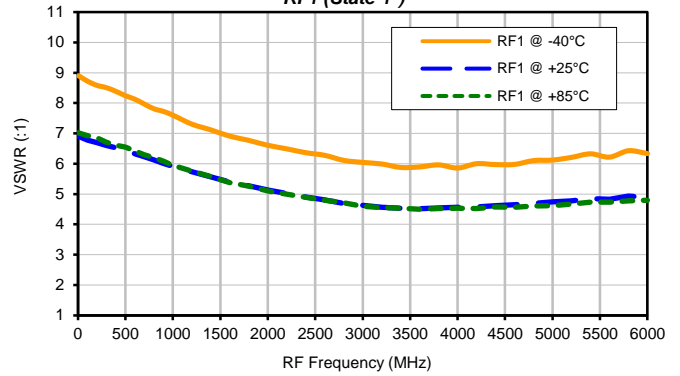

**VSWR @ Vdd=+3.3V over Temperature
RF2 (State 1*)**

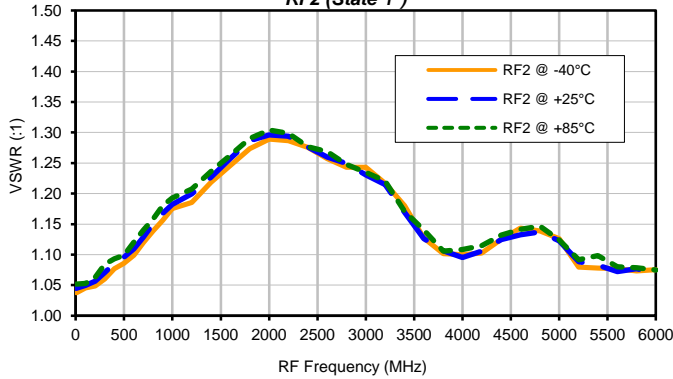

**VSWR @ Vdd=+3.3V over Temperature
RF2 (State 2*)**

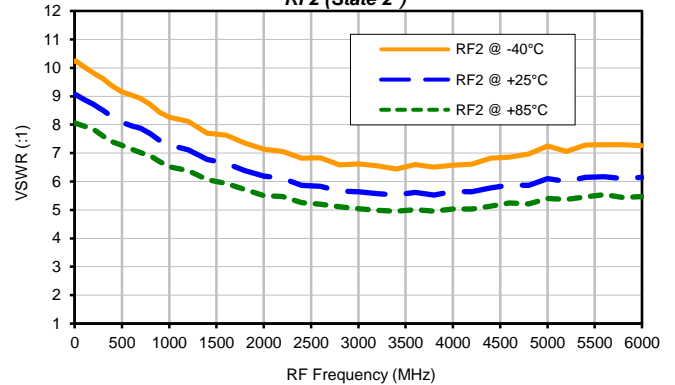

*Note:

STATE	CONTROL INPUT	RF Com to RF1	RF Com to RF2
1	Low	OFF	ON
2	High	ON	OFF

Outline Dimensions

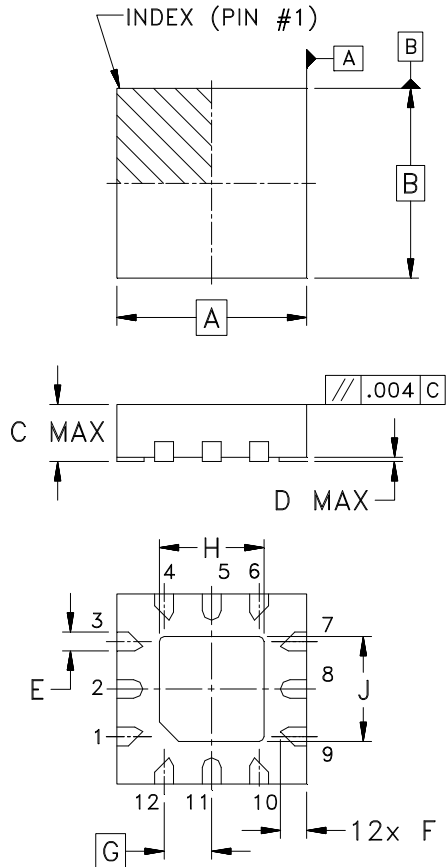

PCB Land Pattern

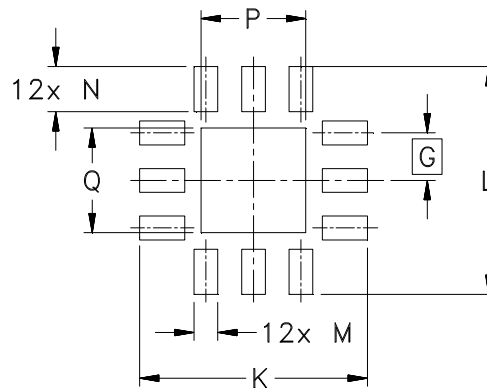

Suggested Layout,
Tolerance to be within $\pm .002$

CASE#	A	B	C	D	E	F	G	H	J	K	L	M	N
MT2140	.079 (2.00)	.079 (2.00)	.024 (0.60)	.002 (0.05)	.008 (0.20)	.011 (0.275)	.020 (0.50)	.043 (1.10)	.043 (1.10)	.094 (2.40)	.094 (2.40)	.010 (0.25)	.019 (0.475)

CASE#	P	Q	R	WT, GRAM
MT2140	.043 (1.10)	.043 (1.10)	-- --	.010

Dimensions are in inches (mm). Tolerances: 3 Pl. $\pm .002$

Notes:

1. Case material: Plastic.
2. Termination finish: Ni Pd Au.



INTERNET <http://www.minicircuits.com>

P.O. Box 350166, Brooklyn, New York 11235-0003 (718) 934-4500 Fax (718) 332-4661

Distribution Centers NORTH AMERICA 800-654-7949 • 417-335-5935 • Fax 417-335-5945 • EUROPE 44-1252-832600 • Fax 44-1252-837010

Mini-Circuits ISO 9001 & ISO 14001 Certified

Tape & Reel Packaging TR-F108

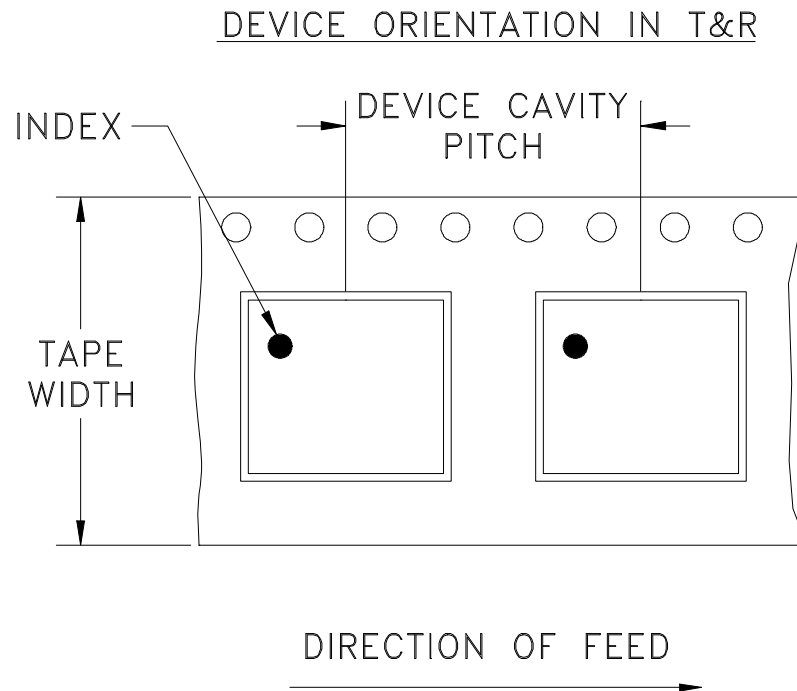

Tape Width, mm	Device Cavity Pitch, mm	Reel Size, inches	Devices per Reel	
12	4	7	Small quantity standards	20
				50
				100
				200
				500
				1000
		7	Standard	2000
				3000

Note: Please Consult individual data sheet to determine device per reel availability

Mini-Circuits carrier tape materials provide protection from ESD (Electro-Static Discharge) during handling and transportation. Tapes are static dissipative and comply with industry standards EIA-481/EIA-541.

Go to: www.minicircuits.com/pages/pdfs/tape.pdf

Mini-Circuits®

INTERNET <http://www.minicircuits.com>

P.O. Box 350166, Brooklyn, New York 11235-0003 (718) 934-4500 Fax (718) 332-4661

Distribution Centers NORTH AMERICA 800-654-7949 • 417-335-5935 • Fax 417-335-5945 • EUROPE 44-1252-832600 • Fax 44-1252-837010

Mini-Circuits ISO 9001 & ISO 14001 Certified

THIRD ANGLE PROJECTION

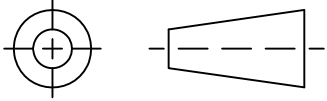

REVISIONS

REV	ECN No.	DESCRIPTION	DATE	DR	AUTH
OR	M160865	NEW RELEASE	03/24/17	ITG	GH
A	M166716	PIN #11 DISCONNECTED FROM PADDLE	03/16/18	ITG	RS

SUGGESTED MOUNTING CONFIGURATION
FOR MT2140 CASE STYLE, "12SW02" PIN CODE

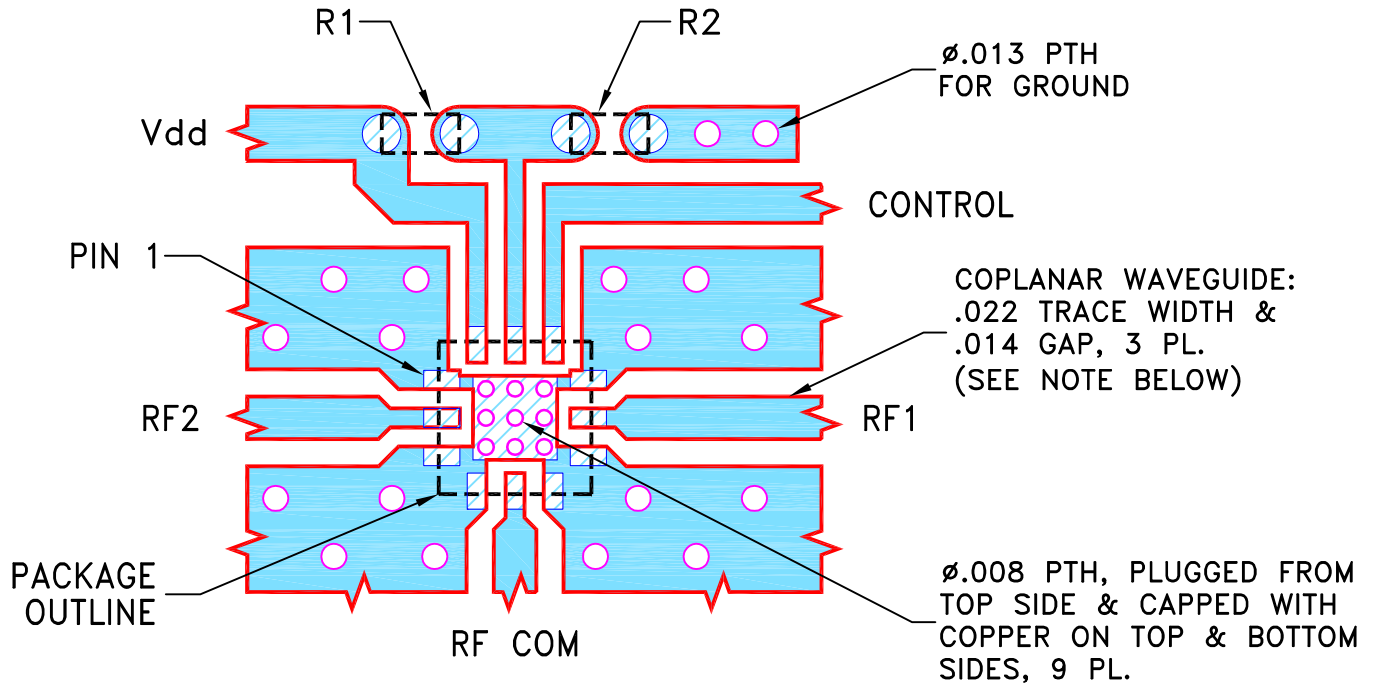

COMPONENT	SIZE
R1, R2	0402

NOTES:

1. TRACE WIDTH & GAP PARAMETERS ARE SHOWN FOR ROGERS R04350B WITH DIELECTRIC THICKNESS .010"±.001". COPPER: 1/2 OZ. EACH SIDE. FOR OTHER MATERIALS TRACE WIDTH & GAP MAY NEED TO BE MODIFIED.
2. CHIP COMPONENT FOOT PRINTS SHOWN FOR REFERENCE. FOR COMPONENT VALUES REFER TO TB-948+.
3. BOTTOM SIDE OF THE PCB IS CONTINUOUS GROUND PLANE.



DENOTES PCB COPPER LAYOUT WITH SMOBC (SOLDER MASK OVER BARE COPPER).

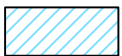

DENOTES COPPER LAND PATTERN FREE OF SOLDER MASK.

UNLESS OTHERWISE SPECIFIED	INITIALS	DATE
DIMENSIONS ARE IN INCHES	DRAWN ITG	03/23/17
TOLERANCES ON:	CHECKED GF	03/23/17
2 PL DECIMALS ±	APPROVED GH	03/23/17
3 PL DECIMALS ± .005		
ANGLES ±		
FRACTIONS ±		



Mini-Circuits®

13 Neptune Avenue
Brooklyn NY 11235

PL, 12SW02, MT2140, TB-948+

SIZE	CODE IDENT	DRAWING NO:	REV:
A	15542	98-PL-505	A
FILE:	98PL505	SCALE: 10:1	SHEET: 1 OF 1

THIS DOCUMENT AND ITS CONTENTS ARE THE PROPERTY OF MINI-CIRCUITS. EXCEPT FOR USE EXPRESSLY GRANTED, IN WRITING, TO ITS VENDORS, VENDEE AND THE UNITED STATES GOVERNMENT, MINI-CIRCUITS RESERVES ALL PROPRIETARY DESIGN, USE, MANUFACTURING AND REPRODUCTION RIGHTS THERETO. THESE CONTENTS SHALL NOT BE USED, DUPLICATED OR DISCLOSED TO ANY OUTSIDE PARTY, IN WHOLE OR IN PART, WITHOUT WRITTEN PERMISSION OF MINI-CIRCUITS.

Evaluation Board and Circuit

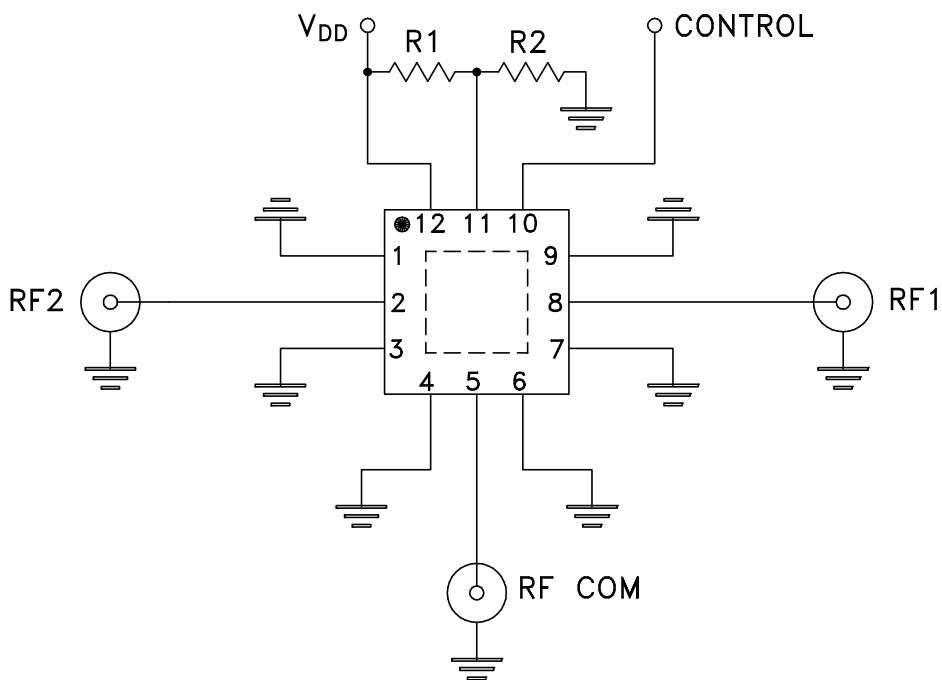
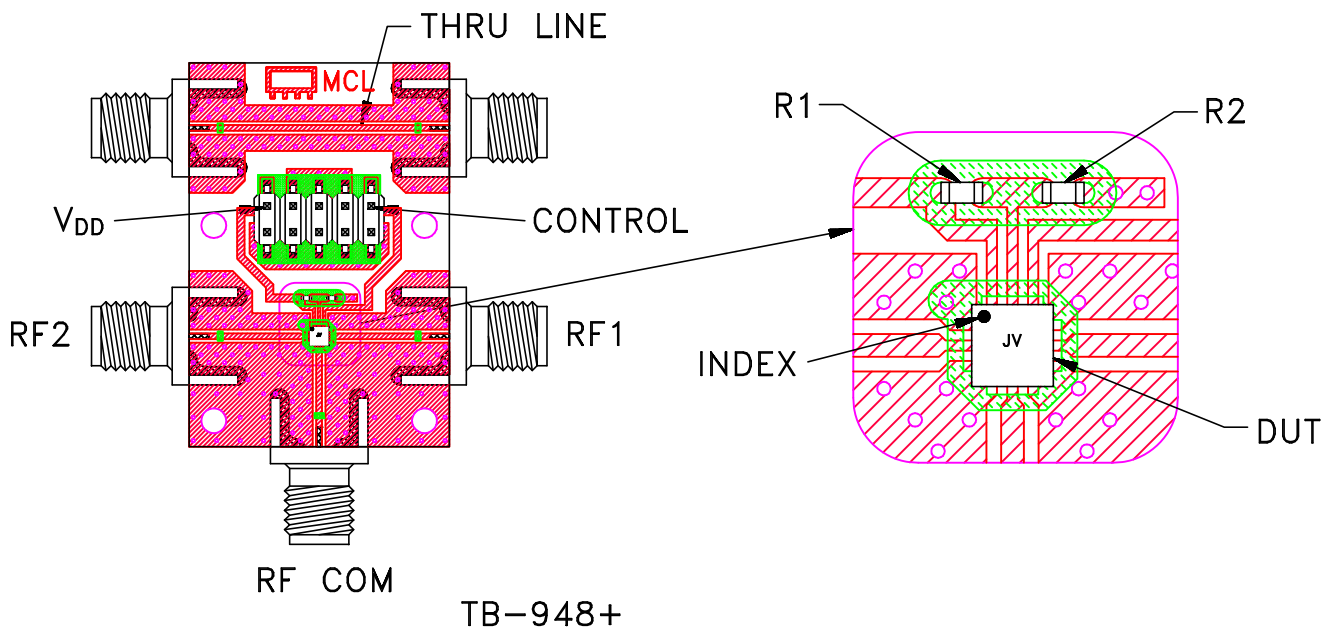

COMPONENT	VALUE	SIZE
DUT	JSW2-63VHDRP+	2X2 MM
R1	Resistor 2.21 KOhm	0402
R2	Resistor 3.32 KOhm	

Schematic Diagram

Notes:

1. 50 Ohm SMA Female connectors.
2. PCB Material: R04350 or equivalent,
Dielectric Constant=3.5, Thickness=.010 inch.

 **Mini-Circuits®**



All Mini-Circuits products are manufactured under exacting quality assurance and control standards, and are capable of meeting published specifications after being subjected to any or all of the following physical and environmental test.

Specification	Test/Inspection Condition	Reference/Spec
Operating Temperature	-40° to 85° C or -40° to 105° C Ambient Environment	Refer to Individual Model Data Sheet
Storage Temperature	-55° to 100° C or -65° to 150° C Ambient Environment	Refer to Individual Model Data Sheet
Temperature Humidity Bias	85°C, 85% RH, 168 hours	J-STD-020
Temperature Cycling	-65° to +150°C, 500 cycles	MIL-STD-883, Method 1010.8 / JESD22-A104
High Temp Storage	150°C, 1000 hours	MIL-STD-883, Method 1008.2 / JESD22-A103
Solder Reflow Heat	Pb-Free Process: 260°C peak	J-STD-020, Table 4-1, 4-2 and 5-2; Figure 5-1
Solderability	Per Standard	MIL-STD-883, Method 2003.9 / JESD22-B102
Marking Resistance to Solvents	Laser marked, visual observation	Mini-Circuits D4-Q4T0-04