

Surface Mount

Power Splitter/Combiner

JPS-2-1+
JPS-2-1

2 Way-0° 50Ω 1 to 500 MHz



Generic photo used for illustration purposes only

CASE STYLE: BH292

+RoHS Compliant

The +Suffix identifies RoHS Compliance. See our web site for RoHS Compliance methodologies and qualifications

Maximum Ratings

Operating Temperature	-40°C to 85°C
Storage Temperature	-55°C to 100°C
Power Input (as a splitter)	1W max.
Internal Dissipation	0.125W max.

Permanent damage may occur if any of these limits are exceeded.

Pin Connections

SUM PORT	1
PORT 1	3
PORT 2	4
GROUND	6
NOT USED	2,5

Outline Drawing

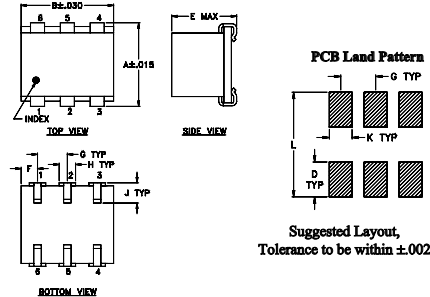

Outline Dimensions (inch/mm)

A	B	C	D	E	F	G
.280	.310	--	.100	.225	.055	.100
7.11	7.87	--	2.54	5.72	1.40	2.54

H	J	K	L	wt
.047	.065	.065	.300	grams
1.19	1.65	1.65	7.62	0.45

Demo Board MCL P/N: TB-48+ Suggested PCB Layout (PL-035)

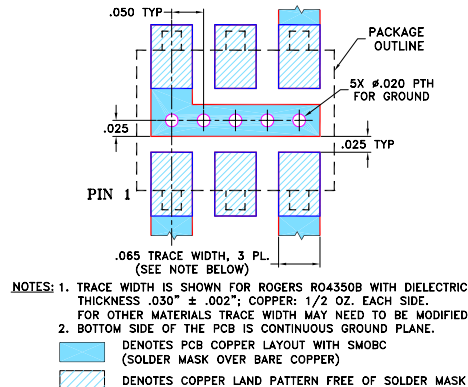

Notes

- Performance and quality attributes and conditions not expressly stated in this specification document are intended to be excluded and do not form a part of this specification document.
- Electrical specifications and performance data contained in this specification document are based on Mini-Circuit's applicable established test performance criteria and measurement instructions.
- The parts covered by this specification document are subject to Mini-Circuit's standard limited warranty and terms and conditions (collectively, "Standard Terms"); Purchasers of this part are entitled to the rights and benefits contained therein. For a full statement of the Standard Terms and the exclusive rights and remedies thereunder, please visit Mini-Circuit's website at www.minicircuits.com/MCLStore/terms.jsp

Features

- low insertion loss, 0.25 dB typ.
- excellent insertion loss flatness, 0.3 dB peak to peak
- excellent amplitude unbalance, 0.1 dB typ.
- very good phase unbalance, 0.1 deg. typ.
- J-leads for excellent solderability and strain relief

Applications

- VHF receivers/transmitters
- instrumentation

Electrical Specifications

FREQ. RANGE (MHz)	ISOLATION (dB)						INSERTION LOSS (dB) ABOVE 3.0 dB						PHASE UNBALANCE (Degrees)			AMPLITUDE UNBALANCE (dB)		
	L		M		U		L		M		U		L	M	U	L	M	U
	Typ.	Min	Typ.	Min	Typ.	Min	Typ.	Max.	Typ.	Max.	Typ.	Max.	Max.	Max.	Max.	Max.	Max.	Max.
$f_c - f_u$																		
1-500	34	20	30	20	27	20	0.2	0.8	0.25	0.7	0.4	0.9	1.0	2.0	3.0	0.1	0.2	0.3

L = 1-10 MHz M = 10-250 MHz U = 250-500 MHz

Typical Performance Data

Frequency (MHz)	Total Loss ¹ (dB)		Amplitude Unbalance (dB)	Isolation (dB)	Phase Unbalance (deg.)	VSWR S	VSWR 1	VSWR 2
	S-1	S-2						
1.00	3.36	3.29	0.06	29.23	0.10	1.07	1.30	1.30
5.00	3.23	3.18	0.05	34.66	0.09	1.09	1.21	1.21
30.00	3.20	3.14	0.05	32.92	0.05	1.10	1.19	1.20
50.00	3.21	3.16	0.05	32.19	0.17	1.11	1.19	1.20
70.00	3.22	3.16	0.06	31.58	0.09	1.11	1.19	1.19
100.00	3.25	3.17	0.08	30.87	0.02	1.12	1.19	1.19
130.00	3.26	3.19	0.08	30.21	0.09	1.12	1.19	1.19
160.00	3.29	3.19	0.11	29.71	0.02	1.13	1.19	1.19
190.00	3.29	3.20	0.10	29.18	0.07	1.14	1.19	1.19
230.00	3.33	3.24	0.09	28.58	0.11	1.15	1.18	1.19
290.00	3.37	3.25	0.12	27.91	0.04	1.16	1.18	1.18
340.00	3.40	3.30	0.10	27.53	0.02	1.17	1.18	1.18
400.00	3.42	3.30	0.12	27.41	0.01	1.18	1.18	1.18
460.00	3.49	3.38	0.11	27.55	0.16	1.20	1.18	1.18
500.00	3.52	3.39	0.13	27.81	0.32	1.21	1.19	1.19

1. Total Loss = Insertion Loss + 3dB splitter loss.

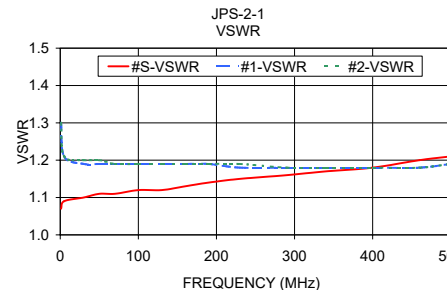
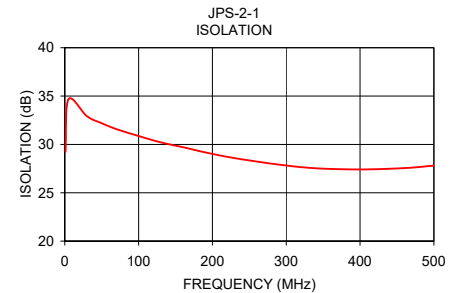
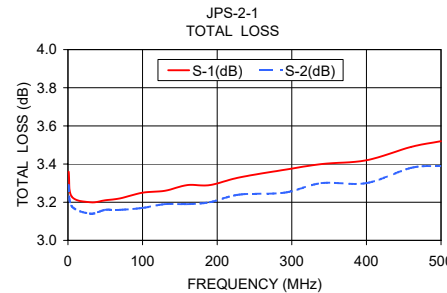

electrical schematic

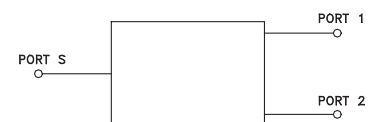

2 Way-0° Power Splitter/Combiner

JPS-2-1

Typical Performance Data

TEST CONDITIONS: INPUT POWER = 0dBm @Temperature = +25°C

FREQ. (MHz)	TOTAL LOSS ¹ (dB)		AMP. UNBAL. (dB)	PHASE UNBAL. (deg.)	ISOLATION (dB)	VSWR (:1)		
	S-1	S-2				S	1	2
1	3.41	3.41	0.00	0.00	24.25	1.10	1.41	1.41
10	3.19	3.19	0.00	0.06	31.77	1.10	1.23	1.23
20	3.18	3.17	0.01	0.04	31.89	1.11	1.22	1.22
30	3.18	3.18	0.00	0.06	31.51	1.11	1.22	1.22
40	3.19	3.19	0.00	0.08	31.02	1.11	1.22	1.22
50	3.20	3.19	0.01	0.08	30.69	1.11	1.21	1.22
60	3.21	3.20	0.01	0.12	30.37	1.12	1.21	1.22
70	3.22	3.21	0.01	0.17	30.12	1.12	1.21	1.21
80	3.23	3.22	0.01	0.15	29.90	1.12	1.21	1.21
90	3.24	3.22	0.02	0.18	29.68	1.12	1.21	1.21
100	3.24	3.23	0.01	0.20	29.38	1.12	1.21	1.21
125	3.26	3.24	0.02	0.29	28.69	1.13	1.20	1.21
150	3.28	3.26	0.02	0.30	28.20	1.13	1.20	1.21
175	3.29	3.27	0.02	0.35	27.73	1.14	1.20	1.20
200	3.31	3.29	0.02	0.38	27.27	1.15	1.20	1.20
225	3.33	3.30	0.03	0.41	26.84	1.15	1.19	1.20
250	3.34	3.31	0.03	0.45	26.46	1.16	1.19	1.20
275	3.36	3.32	0.04	0.46	26.08	1.17	1.19	1.20
300	3.37	3.34	0.03	0.48	25.74	1.18	1.19	1.19
325	3.40	3.36	0.04	0.49	25.39	1.19	1.19	1.19
350	3.41	3.37	0.04	0.53	25.08	1.19	1.18	1.19
375	3.42	3.38	0.04	0.52	24.77	1.20	1.18	1.19
400	3.44	3.39	0.05	0.52	24.53	1.21	1.18	1.19
425	3.46	3.40	0.06	0.52	24.28	1.22	1.18	1.19
450	3.49	3.42	0.07	0.52	24.06	1.23	1.19	1.19
475	3.51	3.44	0.07	0.48	23.84	1.23	1.19	1.19
500	3.53	3.45	0.08	0.45	23.63	1.24	1.19	1.19
525	3.56	3.47	0.09	0.41	23.46	1.26	1.19	1.19
550	3.59	3.49	0.10	0.35	23.29	1.27	1.20	1.20
575	3.62	3.52	0.10	0.30	23.08	1.29	1.21	1.20
600	3.67	3.55	0.12	0.24	22.81	1.30	1.22	1.21
625	3.71	3.58	0.13	0.18	22.49	1.33	1.23	1.22
650	3.76	3.62	0.14	0.09	22.09	1.36	1.24	1.22
675	3.81	3.66	0.15	0.00	21.61	1.39	1.26	1.24
700	3.87	3.71	0.16	0.14	21.01	1.43	1.28	1.25
725	3.96	3.78	0.18	0.28	20.33	1.49	1.31	1.27
750	4.04	3.85	0.19	0.45	19.55	1.55	1.33	1.29
775	4.15	3.94	0.21	0.59	18.67	1.62	1.37	1.32
800	4.28	4.05	0.23	0.76	17.72	1.70	1.40	1.34
825	4.43	4.18	0.25	0.93	16.76	1.80	1.44	1.38
850	4.59	4.33	0.26	1.21	15.78	1.92	1.49	1.41
875	4.81	4.53	0.28	1.45	14.80	2.06	1.54	1.45
900	5.05	4.76	0.29	1.77	13.84	2.22	1.59	1.50
950	5.69	5.34	0.35	2.50	12.04	2.62	1.72	1.60
975	6.09	5.71	0.38	2.87	11.24	2.86	1.78	1.65
1000	6.52	6.14	0.39	3.28	10.48	3.13	1.85	1.71

¹Total Loss = Insertion Loss + 3dB Splitter Loss

REV. X2
JPS-2-1
100622
Page 1 of 3



IF/RF MICROWAVE COMPONENTS • ISO 9001 ISO 14001 AS 9100 CERTIFIED RoHS compliant
P.O. Box 350166, Brooklyn, New York 11235-0003 (718) 934-4500 Fax (718) 332-4661



The Design Engineers Search Engine finds the model you need, Instantly • For detailed performance specs & shopping online see



2 Way-0° Power Splitter/Combiner

JPS-2-1

Typical Performance Data

TEST CONDITIONS: INPUT POWER = 0dBm @Temperature = -40°C

FREQ. (MHz)	TOTAL LOSS ¹ (dB)		AMP. UNBAL. (dB)	PHASE UNBAL. (deg.)	ISOLATION (dB)	VSWR (:1)		
	S-1	S-2				S	1	2
1	3.23	3.23	0.00	0.01	21.84	1.11	1.56	1.56
10	3.15	3.16	0.01	0.02	29.32	1.10	1.22	1.23
20	3.14	3.15	0.01	0.05	34.72	1.11	1.20	1.20
30	3.14	3.15	0.01	0.07	37.44	1.12	1.19	1.20
40	3.15	3.16	0.01	0.11	38.13	1.12	1.18	1.20
50	3.15	3.16	0.01	0.16	37.25	1.12	1.18	1.19
60	3.17	3.17	0.00	0.16	35.57	1.13	1.18	1.19
70	3.17	3.18	0.01	0.18	33.89	1.13	1.18	1.18
80	3.18	3.18	0.00	0.23	32.59	1.13	1.18	1.18
90	3.18	3.19	0.01	0.24	31.71	1.13	1.18	1.17
100	3.19	3.18	0.01	0.24	31.06	1.13	1.18	1.16
125	3.20	3.19	0.01	0.22	30.36	1.12	1.18	1.16
150	3.21	3.21	0.00	0.29	29.98	1.14	1.17	1.17
175	3.22	3.22	0.00	0.37	28.50	1.16	1.17	1.18
200	3.24	3.24	0.00	0.46	27.30	1.18	1.18	1.19
225	3.25	3.24	0.01	0.53	26.76	1.18	1.18	1.19
250	3.25	3.24	0.01	0.59	26.61	1.18	1.17	1.18
275	3.27	3.26	0.01	0.70	26.09	1.19	1.17	1.19
300	3.28	3.27	0.01	0.81	25.36	1.20	1.17	1.18
325	3.30	3.28	0.02	0.92	24.93	1.21	1.18	1.17
350	3.31	3.28	0.03	0.98	24.81	1.20	1.18	1.16
375	3.32	3.29	0.03	1.05	24.69	1.21	1.17	1.17
400	3.33	3.30	0.03	1.14	24.34	1.22	1.17	1.17
425	3.35	3.31	0.04	1.22	24.08	1.23	1.17	1.18
450	3.36	3.32	0.04	1.35	23.98	1.23	1.17	1.18
475	3.38	3.33	0.05	1.46	23.95	1.24	1.18	1.18
500	3.40	3.34	0.06	1.58	23.80	1.25	1.18	1.19
525	3.42	3.36	0.06	1.74	23.65	1.26	1.19	1.19
550	3.44	3.37	0.07	1.90	23.55	1.27	1.20	1.19
575	3.47	3.39	0.08	2.05	23.31	1.29	1.21	1.20
600	3.50	3.41	0.09	2.24	22.98	1.31	1.21	1.20
625	3.53	3.44	0.09	2.41	22.59	1.33	1.23	1.21
650	3.58	3.47	0.11	2.60	22.23	1.36	1.24	1.22
675	3.63	3.51	0.12	2.80	21.68	1.40	1.26	1.23
700	3.69	3.56	0.13	3.05	21.00	1.45	1.28	1.25
725	3.76	3.62	0.14	3.26	20.23	1.50	1.31	1.27
750	3.84	3.68	0.16	3.52	19.45	1.56	1.33	1.29
775	3.93	3.76	0.17	3.75	18.55	1.63	1.37	1.31
800	4.05	3.87	0.19	4.00	17.58	1.72	1.40	1.34
825	4.19	3.99	0.20	4.24	16.58	1.83	1.44	1.38
850	4.34	4.13	0.21	4.56	15.60	1.95	1.49	1.41
875	4.55	4.31	0.24	4.92	14.64	2.09	1.54	1.45
900	4.77	4.53	0.24	5.30	13.68	2.27	1.60	1.50
950	5.38	5.10	0.28	6.24	11.86	2.71	1.73	1.61
975	5.81	5.47	0.34	6.45	11.04	2.96	1.80	1.66
1000	6.18	5.90	0.28	7.00	10.27	3.31	1.87	1.72

¹Total Loss = Insertion Loss + 3dB Splitter Loss

REV. X2
JPS-2-1
100622
Page 2 of 3



IF/RF MICROWAVE COMPONENTS • ISO 9001 ISO 14001 AS 9100 CERTIFIED RoHS compliant
P.O. Box 350166, Brooklyn, New York 11235-0003 (718) 934-4500 Fax (718) 332-4661



The Design Engineers Search Engine finds the model you need, Instantly • For detailed performance specs & shopping online see



2 Way-0° Power Splitter/Combiner

JPS-2-1

Typical Performance Data

TEST CONDITIONS: INPUT POWER = 0dBm @Temperature = +85°C

FREQ. (MHz)	TOTAL LOSS ¹ (dB)		AMP. UNBAL. (dB)	PHASE UNBAL. (deg.)	ISOLATION (dB)	VSWR (:1)		
	S-1	S-2				S	1	2
1	3.44	3.44	0.00	0.05	23.62	1.09	1.43	1.43
10	3.21	3.21	0.00	0.08	28.44	1.10	1.26	1.26
20	3.21	3.20	0.01	0.12	28.32	1.10	1.26	1.25
30	3.22	3.21	0.01	0.18	27.89	1.10	1.26	1.25
40	3.23	3.22	0.01	0.26	27.46	1.10	1.26	1.25
50	3.24	3.22	0.02	0.32	27.25	1.10	1.26	1.25
60	3.25	3.23	0.02	0.43	27.19	1.10	1.26	1.25
70	3.26	3.25	0.01	0.53	27.29	1.10	1.26	1.25
80	3.27	3.25	0.02	0.57	27.52	1.11	1.25	1.25
90	3.28	3.27	0.01	0.63	27.76	1.11	1.24	1.26
100	3.28	3.28	0.00	0.69	27.91	1.12	1.24	1.26
125	3.29	3.29	0.00	0.79	27.55	1.13	1.23	1.26
150	3.32	3.31	0.01	0.86	26.90	1.13	1.23	1.25
175	3.34	3.32	0.02	1.02	26.67	1.12	1.23	1.24
200	3.36	3.33	0.03	1.18	26.92	1.12	1.22	1.23
225	3.37	3.35	0.02	1.31	26.93	1.13	1.21	1.23
250	3.39	3.36	0.03	1.41	26.42	1.15	1.21	1.22
275	3.41	3.38	0.03	1.53	25.96	1.15	1.21	1.21
300	3.43	3.40	0.03	1.68	25.84	1.16	1.21	1.21
325	3.45	3.42	0.03	1.80	25.79	1.17	1.21	1.21
350	3.46	3.43	0.03	1.91	25.50	1.18	1.20	1.22
375	3.48	3.45	0.03	2.00	25.08	1.19	1.20	1.22
400	3.50	3.46	0.04	2.10	24.79	1.20	1.20	1.21
425	3.52	3.48	0.04	2.22	24.62	1.20	1.20	1.21
450	3.55	3.50	0.05	2.30	24.40	1.21	1.20	1.21
475	3.57	3.52	0.05	2.37	24.10	1.23	1.20	1.21
500	3.60	3.54	0.06	2.42	23.81	1.24	1.20	1.20
525	3.64	3.56	0.08	2.45	23.63	1.25	1.20	1.20
550	3.67	3.59	0.08	2.48	23.44	1.27	1.21	1.21
575	3.71	3.62	0.09	2.52	23.26	1.28	1.21	1.21
600	3.75	3.65	0.10	2.54	23.00	1.30	1.22	1.21
625	3.80	3.69	0.11	2.56	22.74	1.32	1.23	1.22
650	3.86	3.73	0.13	2.57	22.38	1.35	1.24	1.23
675	3.92	3.77	0.15	2.55	21.95	1.38	1.26	1.23
700	3.99	3.82	0.17	2.50	21.43	1.42	1.28	1.25
725	4.09	3.90	0.19	2.51	20.80	1.46	1.30	1.26
750	4.20	4.00	0.20	2.71	19.92	1.51	1.33	1.28
775	4.28	4.08	0.20	2.63	19.08	1.58	1.35	1.31
800	4.41	4.19	0.22	2.53	18.20	1.65	1.39	1.33
825	4.54	4.31	0.23	2.41	17.29	1.75	1.42	1.36
850	4.70	4.45	0.25	2.26	16.31	1.86	1.47	1.39
875	4.94	4.65	0.28	2.13	15.30	1.98	1.52	1.43
900	5.20	4.87	0.33	1.78	14.31	2.13	1.58	1.48
950	5.79	5.45	0.34	1.46	12.50	2.48	1.68	1.57
975	6.19	5.83	0.36	1.15	11.67	2.70	1.75	1.62
1000	6.64	6.25	0.39	0.75	10.88	2.95	1.81	1.68

¹Total Loss = Insertion Loss + 3dB Splitter Loss

REV. X2
JPS-2-1
100622
Page 3 of 3



IF/RF MICROWAVE COMPONENTS • ISO 9001 ISO 14001 AS 9100 CERTIFIED RoHS compliant
P.O. Box 350166, Brooklyn, New York 11235-0003 (718) 934-4500 Fax (718) 332-4661



The Design Engineers Search Engine finds the model you need, Instantly • For detailed performance specs & shopping online see



2 Way-0° Power Splitter/Combiner

JPS-2-1

Typical Performance Curves

Total Loss

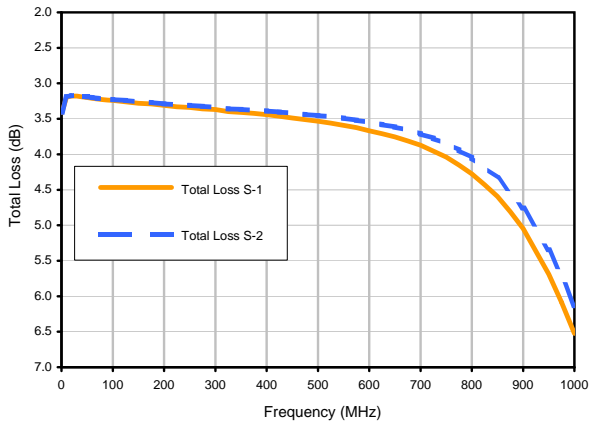

Total Loss S-1 vs. TEMPERATURE

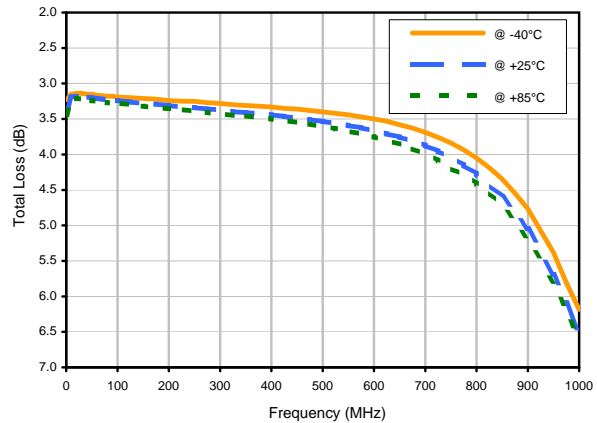

Amplitude Unbalance vs. TEMPERATURE

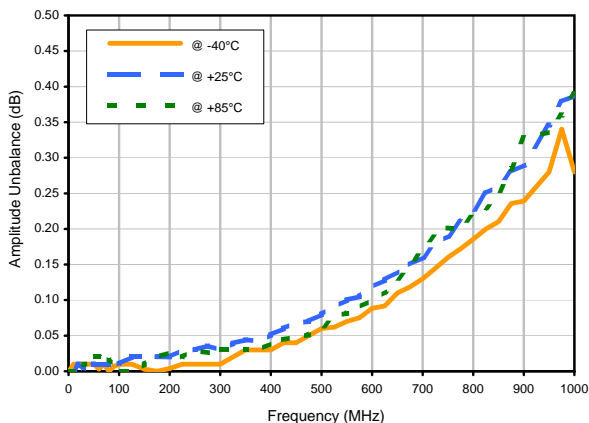

Phase Unbalance vs. TEMPERATURE

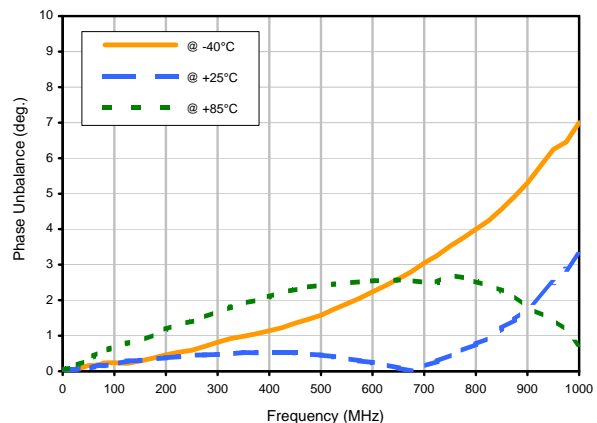

Isolation 1-2 vs. TEMPERATURE

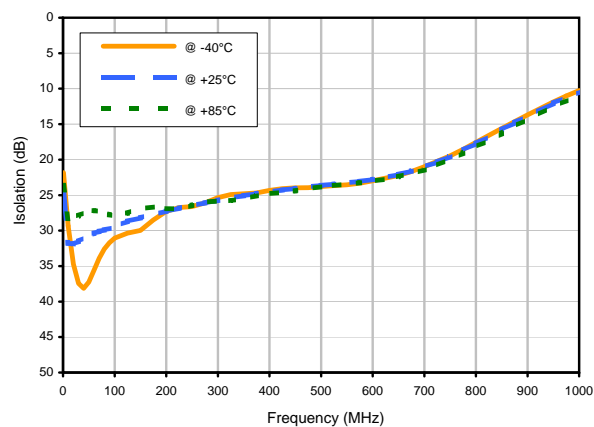

2 Way-0° Power Splitter/Combiner

JPS-2-1

Typical Performance Curves

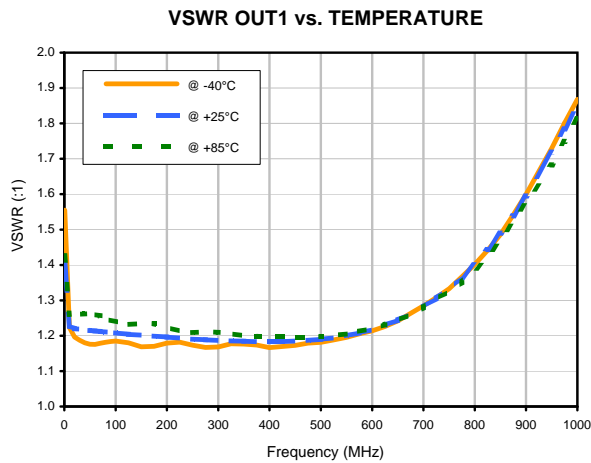
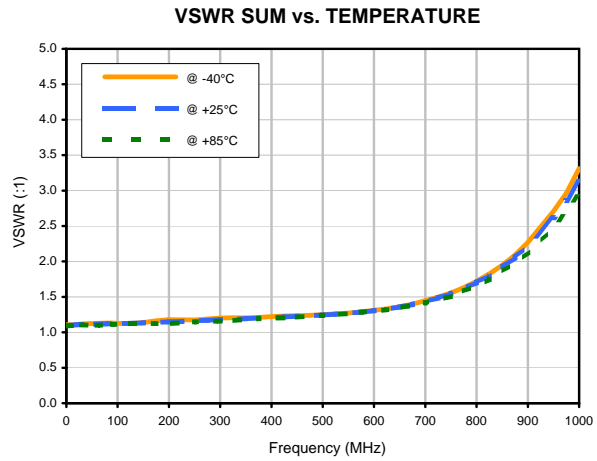
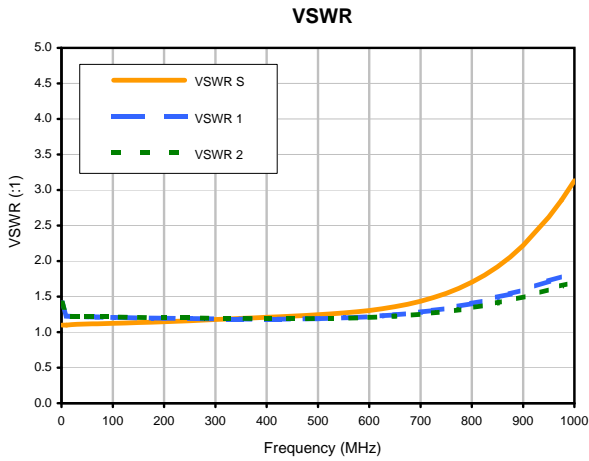

REV. X2
JPS-2-1
100622
Page 2 of 2

Outline Dimensions

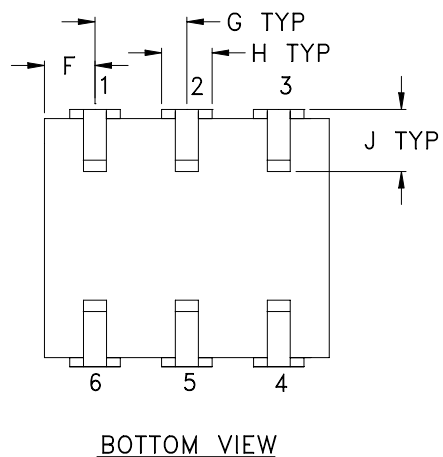
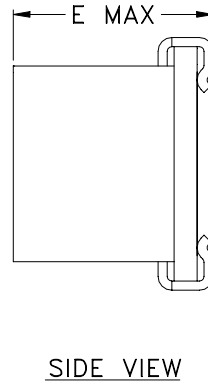
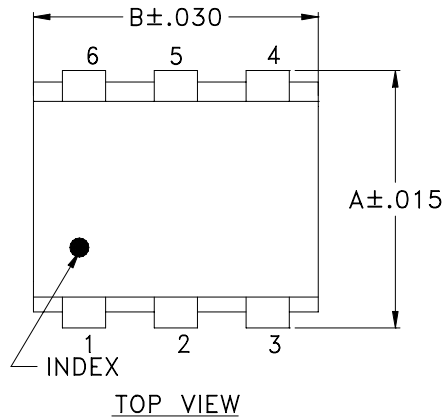

PCB Land Pattern

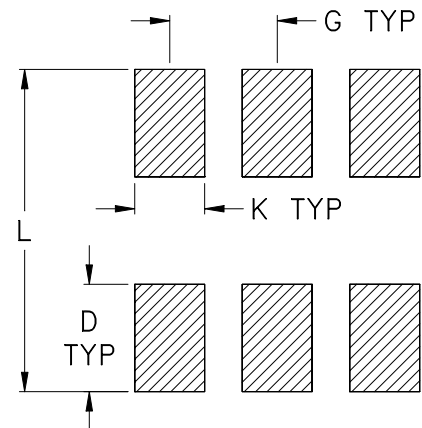

Suggested Layout,
Tolerance to be within $\pm .002$

CASE #	A	B	C	D	E	F	G	H	J	K	L	WT. GRAM
BH292	.280 (7.11)	.310 (7.87)	- -	.100 (2.54)	.225 (5.72)	.055 (1.40)	.100 (2.54)	.047 (1.19)	.065 (1.65)	.065 (1.65)	.300 (7.62)	.45

Dimensions are in inches (mm). Tolerances: 2Pl. $\pm .01$; 3Pl. $\pm .005$

Notes:

- Case material: Ceramic.
- Termination finish:
For RoHS Case Styles: Tin plate over Nickel plate. All models, (+) suffix.
For RoHS-5 Case Styles: Tin-Lead plate. All models, no (+) suffix.

Tape & Reel Packaging TR-F24

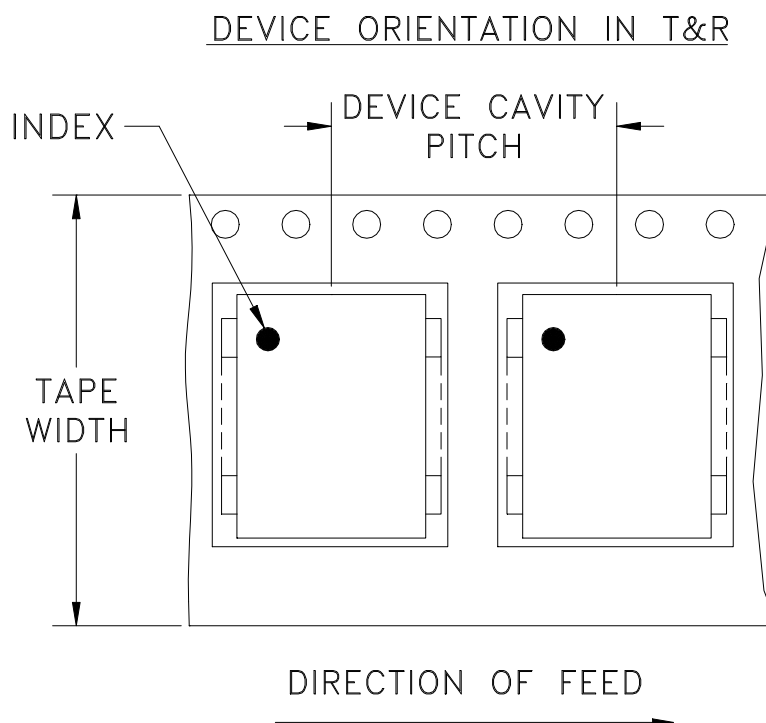

Tape Width, mm	Device Cavity Pitch, mm	Reel Size, inches	Devices per Reel
16	12	13	500

Mini-Circuits carrier tape materials provide protection from ESD (Electro-Static Discharge) during handling and transportation. Tapes are static dissipative and comply with industry standards EIA-481/EIA-541.

Go to: www.minicircuits.com/pages/pdfs/tape.pdf



INTERNET <http://www.minicircuits.com>
P.O. Box 350166, Brooklyn, New York 11235-0003 (718) 934-4500 Fax (718) 332-4661
Distribution Centers NORTH AMERICA 800-654-7949 • 417-335-5935 • Fax 417-335-5945 • EUROPE 44-1252-832600 • Fax 44-1252-837010
Mini-Circuits ISO 9001 & ISO 14001 Certified

THIRD ANGLE PROJECTION

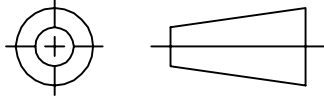

REVISIONS

REV	ECN No.	DESCRIPTION	DATE	DR	AUTH
OR	M77049	NEW RELEASE	05/01	AV	CT
A	M82377	UPDATED DRAWING	07/31/02	AV	HY
B	M82846	UPDATED DRAWING	05/13/03	MMG	HY
C	M102713	ADDED BK292 CASE STYLE & "...WITH SMOBC"	01/17/08	MMG	IL

**SUGGESTED MOUNTING CONFIGURATION
FOR BK292/CD542/CD636 CASE STYLES,
"hv" PIN CONNECTION**

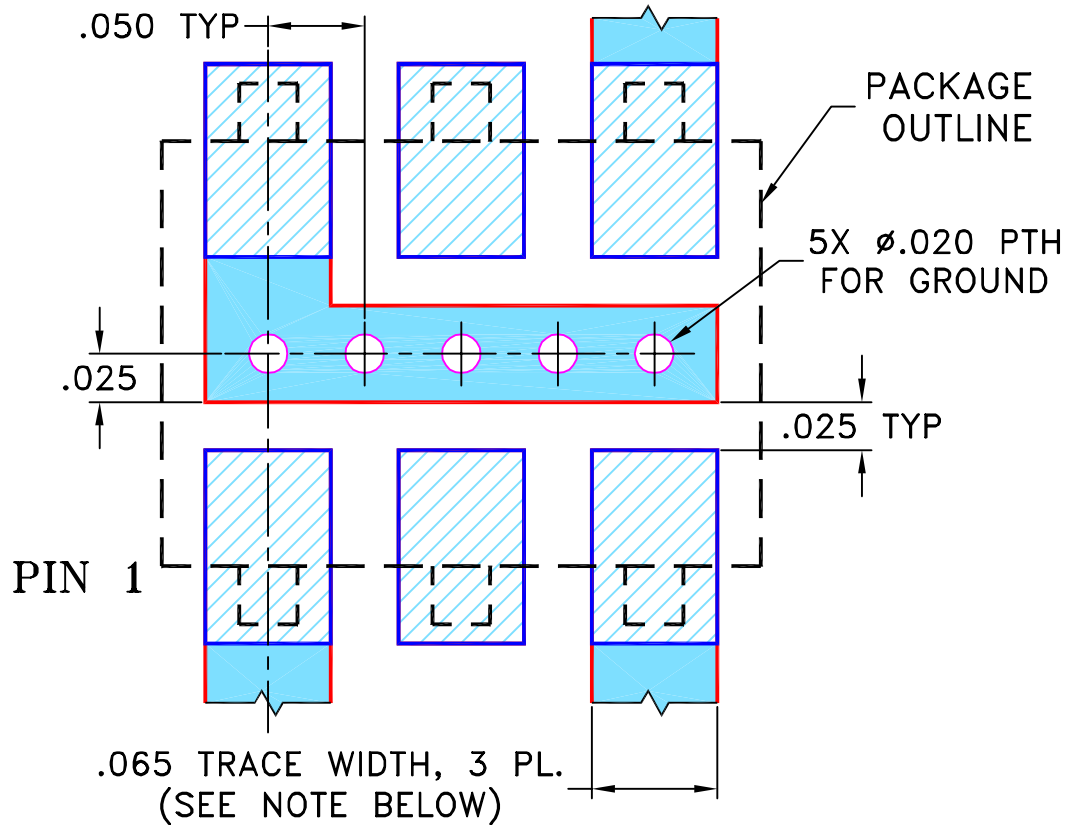

- NOTES:** 1. TRACE WIDTH IS SHOWN FOR ROGERS RO4350B WITH DIELECTRIC THICKNESS .030" ± .002"; COPPER: 1/2 OZ. EACH SIDE. FOR OTHER MATERIALS TRACE WIDTH MAY NEED TO BE MODIFIED.
2. BOTTOM SIDE OF THE PCB IS CONTINUOUS GROUND PLANE.



DENOTES PCB COPPER LAYOUT WITH SMOBC (SOLDER MASK OVER BARE COPPER)

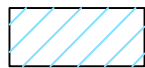

DENOTES COPPER LAND PATTERN FREE OF SOLDER MASK

UNLESS OTHERWISE SPECIFIED

DIMENSIONS ARE IN INCHES
TOLERANCES ON:
2 PL DECIMALS ±
3 PL DECIMALS ± .005
ANGLES ±
FRACTIONS ±

	INITIALS	DATE
DRAWN	AV	05/30/01
CHECKED	DY	06/11/01
APPROVED	CT	06/11/01



Mini-Circuits®

13 Neptune Avenue
Brooklyn NY 11235

PL, hv, BK292/CD542/CD636, ADP/JPS, TB-48

Mini-Circuits®
THIS DOCUMENT AND ITS CONTENTS ARE THE PROPERTY OF MINI-CIRCUITS. EXCEPT FOR USE EXPRESSLY GRANTED, IN WRITING, TO ITS VENDORS, VENDEE AND THE UNITED STATES GOVERNMENT, MINI-CIRCUITS RESERVES ALL PROPRIETARY DESIGN, USE, MANUFACTURING AND REPRODUCTION RIGHTS THERETO. THESE CONTENTS SHALL NOT BE USED, DUPLICATED OR DISCLOSED TO ANY OUTSIDE PARTY, IN WHOLE OR IN PART, WITHOUT WRITTEN PERMISSION OF MINI-CIRCUITS.

ASHEETA1.DWG REV:A DATE:01/12/95

SIZE	CODE IDENT	DRAWING NO:	REV:
A	15542	98-PL-035	C
FILE:	98PL035	SCALE: 10:1	SHEET: 1 OF 1

Evaluation Board and Circuit

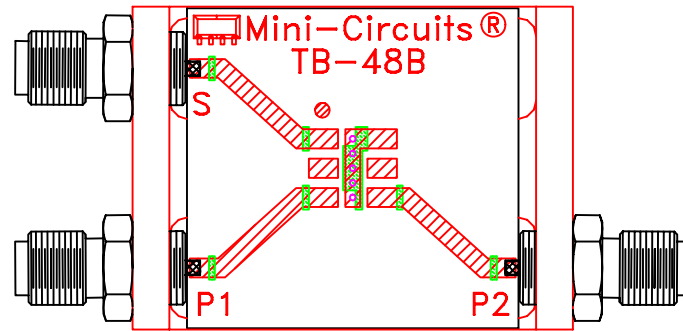

TB-48+

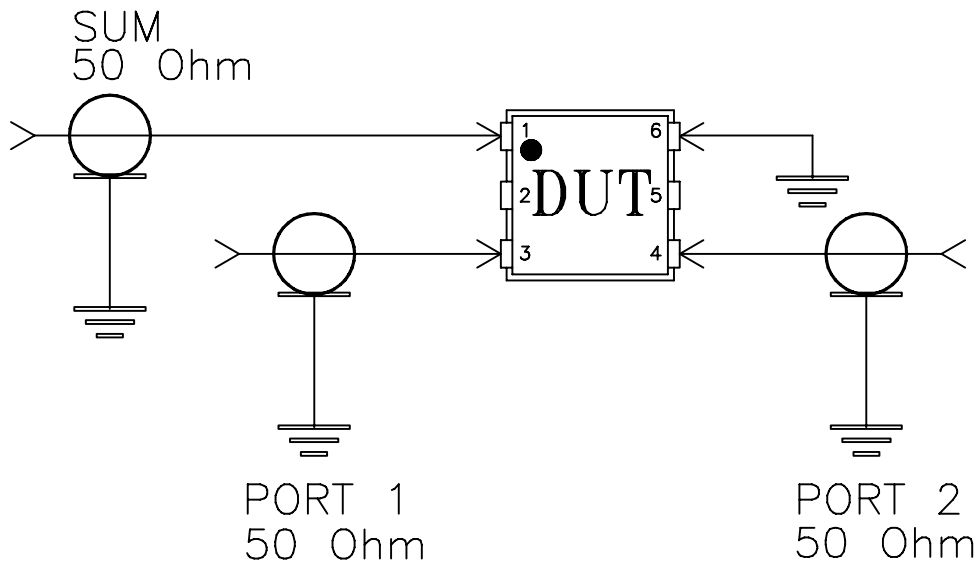

Schematic Diagram

Notes:

1. SMA Female connectors.
2. PCB Material: Rogers R04350 or equivalent,
Dielectric Constant=3.5, Thickness=.030 inch.

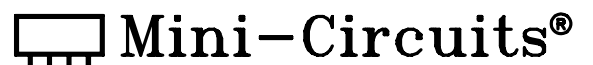



All Mini-Circuits products are manufactured under exacting quality assurance and control standards, and are capable of meeting published specifications after being subjected to any or all of the following physical and environmental test.

Specification	Test/Inspection Condition	Reference/Spec
Operating Temperature	-40° to 85°C Ambient Environment	Individual Model Data Sheet
Storage Temperature	-55° to 100° C Ambient Environment	Individual Model Data Sheet
Humidity	90 to 95% RH, 240 hours, 50°C	MIL-STD-202, Method 103, Condition A, Except 50°C and end-point electrical test done within 12 hours
Thermal Shock	-55° to 100°C, 100 cycles	MIL-STD-202, Method 107, Condition A-3, except +100°C
Solder Reflow Heat	Sn-Pb Eutetic Process: 225°C peak Pb-Free Process 245° - 250°C peak	J-STD-020, Table 4-1, 4-2 and 5-2, Figure 5-1
Solderability	10X Magnification	J-STD-002, 95% Coverage
Vibration (High Frequency)	20g peak, 10-2000 Hz, 12 times in each of three perpendicular directions (total 36)	MIL-STD-202, Method 204, Condition D
Mechanical Shock	50g, 11 ms, 1/2-sine, 18 shocks: 3 each direction, each of 3 axes	MIL-STD-202, Method 213, Condition A
Marking Resistance to Solvents	Isopropyl alcohol + mineral spirits at 25°C; terpene defluxer at 25°C; distilled water + proylene glycol monomethyl ether + monoethanolamine at 63°C to 70°C	MIL-STD-202, Method 215