

Surface Mount

Power Splitter/Combiner

2 Way-90° 50Ω 315 to 395 MHz

HPQ-04+
HPQ-04



CASE STYLE: AT577
PRICE: Contact Sales Dept.

+RoHS Compliant
The +Suffix identifies RoHS Compliance. See our web site for RoHS Compliance methodologies and qualifications

Maximum Ratings

Operating Temperature	-40°C to 85°C
Storage Temperature	-55°C to 100°C
Power Input (as a splitter)	1W max.

Permanent damage may occur if any of these limits are exceeded.

Pin Connections

SUM PORT	3
PORT 1 (0°)	6
PORT 2 (+90°)	4
GROUND	2,5
50 OHM TERM EXTERNAL	1

Outline Drawing

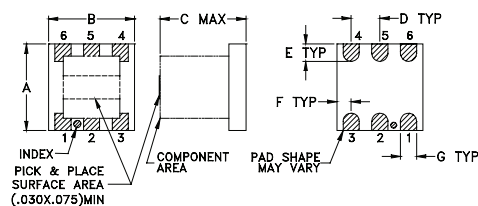

PCB Land Pattern

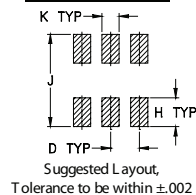

Outline Dimensions (inch)

A	B	C	D	E	F	
.200	.200	.200	.075	.050	.025	
5.08	5.08	5.08	1.91	1.27	0.64	
G	H	J	K			wt
.026	.070	.220	.035			grams
0.66	1.78	5.59	0.89			0.15

Demo Board MCL P/N: TB-43 Suggested PCB Layout (PL-114)

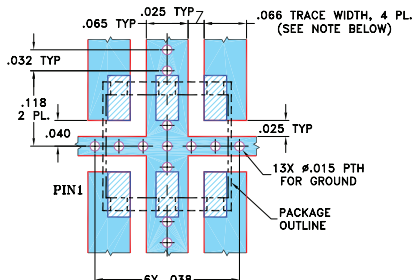

- NOTES: 1. TRACE WIDTH IS SHOWN FOR ROGERS RO4350B WITH DIELECTRIC THICKNESS .030" ± .002"; COPPER: 1/2 OZ. EACH SIDE. FOR OTHER MATERIALS TRACE WIDTH MAY NEED TO BE MODIFIED.
2. BOTTOM SIDE OF THE PCB IS CONTINUOUS GROUND PLANE.
3. DENOTES PCB COPPER LAYOUT WITH SMOBC (SOLDER MASK OVER BARE COPPER)
4. DENOTES COPPER LAND PATTERN FREE OF SOLDER MASK

Features

- excellent amplitude and phase unbalance
- good insertion loss, 0.2 dB typ.
- good isolation, 24 dB typ.
- aqueous washable
- small size

Applications

- UHF
- image rejection mixers
- balanced amplifiers
- I&Q modulators

Electrical Specifications

FREQ. RANGE (MHz)	ISOLATION (dB)		INSERTION LOSS (dB) Avg. of Coupled Outputs ABOVE 3 dB		PHASE UNBALANCE (Degrees)		AMPLITUDE UNBALANCE (dB)		VSWR (:1)	
	Typ.	Min.	Typ.	Max.	Typ.	Max.	Typ.	Max.	S-Port Typ.	Output Typ.
f_L - f_U										
315-395	24	18	0.20	0.45	0.7	3.0	1.0	1.6	1.17	1.15
332-367	27	19	0.17	0.40	0.5	3.0	0.5	1.0	1.17	1.15

Typical Performance Data

Frequency (MHz)	Total Loss ¹ (dB)		Amplitude Unbalance (dB)	Isolation (dB)	Phase Unbalance (deg.)	VSWR S	VSWR 1	VSWR 2
	S-1	S-2						
300.25	2.52	3.89	1.38	26.99	90.25	1.13	1.11	1.13
325.00	2.81	3.53	0.71	26.37	90.37	1.13	1.11	1.14
330.25	2.89	3.45	0.55	26.27	90.34	1.13	1.11	1.14
335.50	2.95	3.38	0.43	26.14	90.30	1.13	1.11	1.14
340.00	3.01	3.31	0.30	26.01	90.39	1.13	1.11	1.14
344.50	3.07	3.27	0.21	25.86	90.29	1.14	1.11	1.14
346.75	3.09	3.23	0.14	25.80	90.40	1.14	1.11	1.14
349.00	3.12	3.21	0.09	25.70	90.32	1.14	1.11	1.14
350.50	3.14	3.19	0.05	25.68	90.50	1.14	1.12	1.14
352.00	3.15	3.18	0.03	25.60	90.37	1.14	1.12	1.14
355.00	3.19	3.13	0.06	25.48	90.42	1.14	1.12	1.14
364.75	3.32	3.02	0.30	25.06	90.33	1.14	1.12	1.15
370.00	3.39	2.97	0.42	24.85	90.42	1.14	1.12	1.15
376.00	3.46	2.90	0.55	24.63	90.48	1.14	1.12	1.15
399.25	3.75	2.67	1.08	24.00	90.59	1.15	1.13	1.15

1. Total Loss = Insertion Loss + 3dB splitter loss.

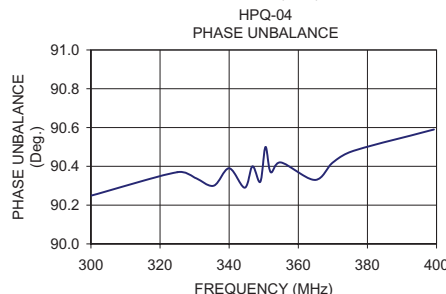
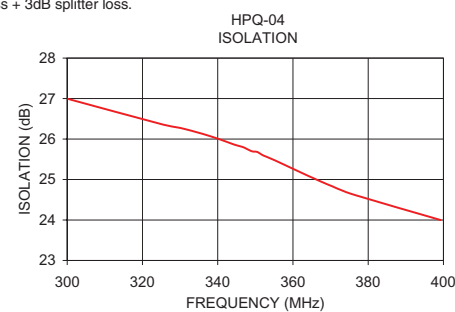
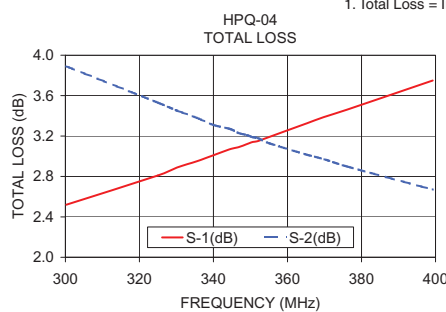

electrical schematic

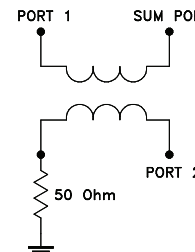

For detailed performance specs & shopping online see web site



P.O. Box 350166, Brooklyn, New York 11235-0003 (718) 934-4500 Fax (718) 332-4661 The Design Engineers Search Engine Provides ACTUAL Data Instantly at minicircuits.com

Notes: 1. Performance and quality attributes and conditions not expressly stated in this specification sheet are intended to be excluded and do not form a part of this specification sheet. 2. Electrical specifications and performance data contained herein are based on Mini-Circuits' applicable established test performance criteria and measurement instructions. 3. The parts covered by this specification sheet are subject to Mini-Circuits standard limited warranty and terms and conditions (collectively, "Standard Terms"); Purchasers of this part are entitled to the rights and benefits contained therein. For a full statement of the Standard Terms and the exclusive rights and remedies thereunder, please visit Mini-Circuits' website at www.minicircuits.com/MCLStore/terms.jsp.

REV. D
M127604
HPQ-04
EDR-5462/1
RVN/TD/CP/AM
130313

2 Way-90° Power Splitter/Combiner

HPQ-04+

Typical Performance Data

TEST CONDITIONS: INPUT POWER = 0dBm @Temperature = +25°C

FREQ. (MHz)	TOTAL LOSS ¹ (dB)		AMP. UNBAL. (dB)	PHASE UNBAL. From 90° (deg.)	ISOLATION (dB) 1-2	VSWR (:1)		
	S-1	S-2				S	1	2
150	0.82	8.35	7.54	0.67	33.33	1.02	1.02	1.02
200	1.31	6.35	5.04	0.66	32.26	1.03	1.03	1.03
250	1.87	4.97	3.10	0.64	31.88	1.05	1.05	1.05
260	1.99	4.75	2.77	0.63	31.84	1.05	1.05	1.05
270	2.11	4.54	2.43	0.61	31.76	1.05	1.05	1.05
280	2.22	4.35	2.12	0.59	31.72	1.05	1.05	1.06
290	2.34	4.16	1.82	0.59	31.65	1.06	1.06	1.06
300	2.46	3.98	1.51	0.58	31.55	1.06	1.06	1.06
310	2.60	3.82	1.22	0.58	31.44	1.06	1.06	1.07
315	2.66	3.75	1.09	0.58	31.36	1.06	1.06	1.07
320	2.72	3.67	0.95	0.57	31.30	1.06	1.06	1.07
332	2.86	3.49	0.63	0.56	31.09	1.07	1.07	1.07
340	2.96	3.38	0.42	0.56	30.97	1.07	1.07	1.07
350	3.08	3.26	0.17	0.58	30.76	1.07	1.07	1.08
360	3.21	3.13	0.08	0.55	30.53	1.07	1.08	1.08
367	3.29	3.05	0.25	0.56	30.36	1.07	1.08	1.08
380	3.46	2.91	0.55	0.55	30.01	1.08	1.08	1.09
390	3.58	2.80	0.78	0.55	29.75	1.08	1.08	1.09
395	3.64	2.75	0.89	0.54	29.59	1.08	1.08	1.09
400	3.70	2.70	1.00	0.55	29.46	1.08	1.08	1.09
410	3.83	2.61	1.22	0.54	29.15	1.08	1.09	1.09
420	3.95	2.52	1.44	0.54	28.81	1.09	1.09	1.10
430	4.08	2.44	1.64	0.52	28.48	1.09	1.09	1.10
440	4.20	2.36	1.84	0.52	28.13	1.09	1.09	1.10
450	4.32	2.29	2.04	0.52	27.80	1.09	1.09	1.11
500	4.93	1.96	2.97	0.52	26.11	1.10	1.10	1.12
550	5.52	1.71	3.81	0.47	24.54	1.10	1.11	1.13
600	6.09	1.51	4.58	0.43	23.12	1.11	1.12	1.14
650	6.64	1.35	5.29	0.40	21.84	1.11	1.13	1.14
700	7.17	1.23	5.94	0.39	20.69	1.12	1.13	1.15
750	7.67	1.12	6.55	0.28	19.65	1.12	1.14	1.16
800	8.15	1.05	7.10	0.20	18.73	1.12	1.15	1.17
850	8.61	0.99	7.62	0.07	17.88	1.13	1.15	1.17
900	9.04	0.95	8.09	0.14	17.10	1.13	1.16	1.18
950	9.44	0.92	8.52	0.40	16.38	1.14	1.17	1.19
1000	9.81	0.90	8.91	0.76	15.70	1.15	1.18	1.20

¹Total Loss = Insertion Loss + 3dB Splitter Loss

REV. X2
HPQ-04+
100621
Page 1 of 3



IF/RF MICROWAVE COMPONENTS • ISO 9001 ISO 14001 AS 9100 CERTIFIED • RoHS compliant
P.O. Box 350166, Brooklyn, New York 11235-0003 (718) 934-4500 Fax (718) 332-4661



The Design Engineers Search Engine finds the model you need, Instantly • For detailed performance specs & shopping online see



2 Way-90° Power Splitter/Combiner

HPQ-04+

Typical Performance Data

TEST CONDITIONS: INPUT POWER = 0dBm @Temperature = -40°C

FREQ. (MHz)	TOTAL LOSS ¹ (dB)		AMP. UNBAL. (dB)	PHASE UNBAL. From 90° (deg.)	ISOLATION (dB) 1-2	VSWR (:1)		
	S-1	S-2				S	1	2
150	0.73	8.48	7.75	0.74	36.88	1.03	1.04	1.03
200	1.20	6.45	5.25	0.84	34.69	1.05	1.05	1.05
250	1.73	5.04	3.31	0.97	33.34	1.06	1.07	1.06
260	1.85	4.81	2.96	1.01	33.03	1.06	1.07	1.06
270	1.96	4.60	2.63	1.01	32.66	1.07	1.07	1.06
280	2.08	4.39	2.31	1.03	32.27	1.07	1.07	1.07
290	2.19	4.20	2.01	1.06	31.89	1.07	1.08	1.07
300	2.31	4.02	1.71	1.09	31.51	1.07	1.08	1.07
310	2.44	3.85	1.42	1.11	31.16	1.07	1.08	1.08
315	2.50	3.78	1.28	1.14	30.98	1.08	1.08	1.08
320	2.55	3.70	1.15	1.14	30.85	1.08	1.08	1.08
332	2.70	3.52	0.82	1.16	30.47	1.08	1.08	1.08
340	2.79	3.40	0.61	1.18	30.24	1.08	1.08	1.08
350	2.91	3.27	0.36	1.22	29.89	1.08	1.09	1.09
360	3.03	3.14	0.11	1.23	29.54	1.08	1.09	1.09
367	3.11	3.06	0.06	1.26	29.29	1.08	1.09	1.09
380	3.27	2.91	0.37	1.29	28.81	1.09	1.09	1.09
390	3.39	2.80	0.59	1.31	28.45	1.09	1.09	1.10
395	3.45	2.75	0.71	1.34	28.26	1.09	1.10	1.10
400	3.51	2.70	0.82	1.36	28.08	1.09	1.10	1.10
410	3.64	2.60	1.03	1.40	27.74	1.09	1.10	1.10
420	3.75	2.51	1.25	1.42	27.41	1.09	1.10	1.11
430	3.88	2.42	1.46	1.43	27.09	1.10	1.10	1.11
440	3.99	2.34	1.65	1.45	26.78	1.10	1.10	1.11
450	4.12	2.27	1.85	1.48	26.45	1.10	1.10	1.11
500	4.71	1.92	2.79	1.63	24.90	1.10	1.11	1.13
550	5.29	1.66	3.63	1.73	23.42	1.11	1.12	1.13
600	5.85	1.45	4.40	1.84	22.21	1.12	1.13	1.14
650	6.38	1.28	5.10	1.95	21.16	1.12	1.13	1.15
700	6.90	1.14	5.76	2.08	20.12	1.12	1.14	1.16
750	7.39	1.03	6.36	2.15	19.23	1.12	1.14	1.17
800	7.86	0.94	6.92	2.22	18.37	1.12	1.15	1.17
850	8.31	0.87	7.43	2.25	17.53	1.13	1.15	1.18
900	8.73	0.82	7.91	2.23	16.80	1.14	1.16	1.18
950	9.13	0.79	8.34	2.11	16.10	1.15	1.17	1.19
1000	9.50	0.76	8.74	1.95	15.50	1.16	1.17	1.20

¹Total Loss = Insertion Loss + 3dB Splitter Loss

REV. X2
HPQ-04+
100621
Page 2 of 3



IF/RF MICROWAVE COMPONENTS • ISO 9001 ISO 14001 AS 9100 CERTIFIED • RoHS compliant
P.O. Box 350166, Brooklyn, New York 11235-0003 (718) 934-4500 Fax (718) 332-4661



The Design Engineers Search Engine finds the model you need, Instantly • For detailed performance specs & shopping online see



2 Way-90° Power Splitter/Combiner

HPQ-04+

Typical Performance Data

TEST CONDITIONS: INPUT POWER = 0dBm @Temperature = +85°C

FREQ. (MHz)	TOTAL LOSS ¹ (dB)		AMP. UNBAL. (dB)	PHASE UNBAL. From 90° (deg.)	ISOLATION (dB) 1-2	VSWR (:1)		
	S-1	S-2				S	1	2
150	0.85	8.33	7.49	0.89	32.51	1.02	1.02	1.02
200	1.35	6.35	5.00	0.85	31.75	1.03	1.03	1.03
250	1.92	4.99	3.07	0.80	31.61	1.04	1.04	1.05
260	2.04	4.77	2.73	0.79	31.58	1.05	1.05	1.05
270	2.16	4.56	2.40	0.78	31.55	1.05	1.05	1.05
280	2.28	4.37	2.09	0.76	31.55	1.05	1.05	1.06
290	2.40	4.18	1.78	0.76	31.55	1.06	1.05	1.06
300	2.52	4.01	1.49	0.74	31.56	1.06	1.05	1.06
310	2.65	3.85	1.20	0.73	31.55	1.06	1.06	1.06
315	2.71	3.77	1.05	0.73	31.54	1.06	1.06	1.07
320	2.77	3.70	0.93	0.72	31.55	1.06	1.06	1.07
332	2.92	3.52	0.60	0.70	31.46	1.07	1.06	1.07
340	3.02	3.41	0.39	0.70	31.37	1.07	1.07	1.07
350	3.14	3.29	0.14	0.69	31.19	1.07	1.07	1.08
360	3.27	3.16	0.11	0.67	30.99	1.07	1.07	1.08
367	3.36	3.09	0.28	0.68	30.82	1.07	1.07	1.08
380	3.52	2.94	0.59	0.67	30.50	1.08	1.08	1.09
390	3.65	2.84	0.81	0.65	30.23	1.08	1.08	1.09
395	3.70	2.79	0.92	0.66	30.08	1.08	1.08	1.09
400	3.77	2.74	1.03	0.67	29.95	1.08	1.08	1.09
410	3.90	2.65	1.25	0.64	29.65	1.08	1.08	1.09
420	4.02	2.56	1.47	0.63	29.31	1.09	1.09	1.10
430	4.15	2.48	1.67	0.61	28.99	1.09	1.09	1.10
440	4.27	2.40	1.87	0.62	28.65	1.09	1.09	1.10
450	4.39	2.33	2.06	0.62	28.31	1.09	1.09	1.10
500	5.00	2.00	3.00	0.60	26.49	1.10	1.10	1.12
550	5.60	1.76	3.84	0.56	24.82	1.10	1.11	1.13
600	6.17	1.56	4.60	0.50	23.33	1.11	1.12	1.14
650	6.72	1.41	5.31	0.45	21.98	1.11	1.13	1.14
700	7.25	1.29	5.96	0.42	20.80	1.11	1.14	1.15
750	7.76	1.19	6.57	0.32	19.73	1.12	1.14	1.16
800	8.23	1.12	7.11	0.19	18.77	1.12	1.15	1.17
850	8.70	1.07	7.63	0.04	17.91	1.12	1.16	1.17
900	9.13	1.03	8.10	0.20	17.11	1.13	1.17	1.18
950	9.53	1.00	8.53	0.47	16.39	1.14	1.18	1.19
1000	9.91	0.99	8.92	0.84	15.71	1.14	1.19	1.20

¹Total Loss = Insertion Loss + 3dB Splitter Loss

REV. X2
HPQ-04+
100621
Page 3 of 3



IF/RF MICROWAVE COMPONENTS • ISO 9001 ISO 14001 AS 9100 CERTIFIED • RoHS compliant
P.O. Box 350166, Brooklyn, New York 11235-0003 (718) 934-4500 Fax (718) 332-4661



The Design Engineers Search Engine finds the model you need, Instantly • For detailed performance specs & shopping online see



2 Way-90° Power Splitter/Combiner

HPQ-04+

Typical Performance Curves

Total Loss

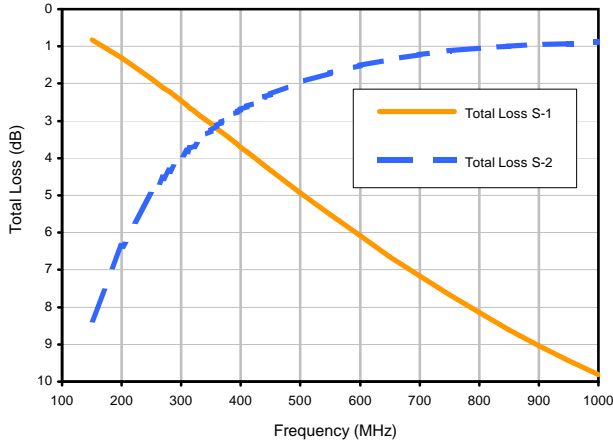

Total Loss S-1 vs. TEMPERATURE

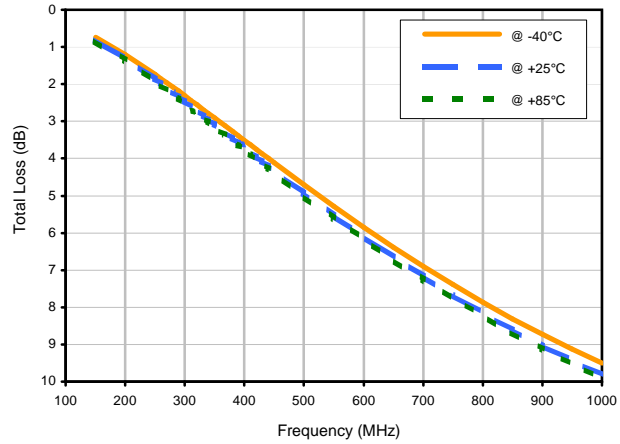

Amplitude Unbalance vs. TEMPERATURE

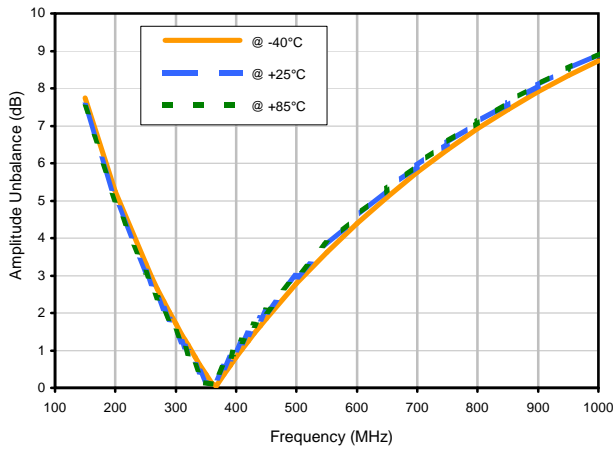

Phase Unbalance vs. TEMPERATURE

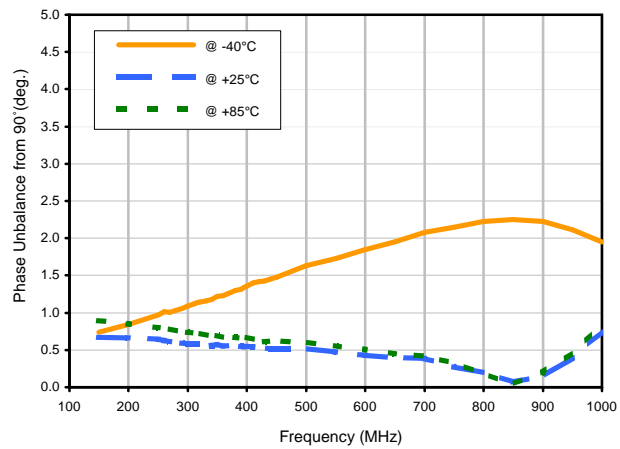

Isolation 1-2 vs. TEMPERATURE

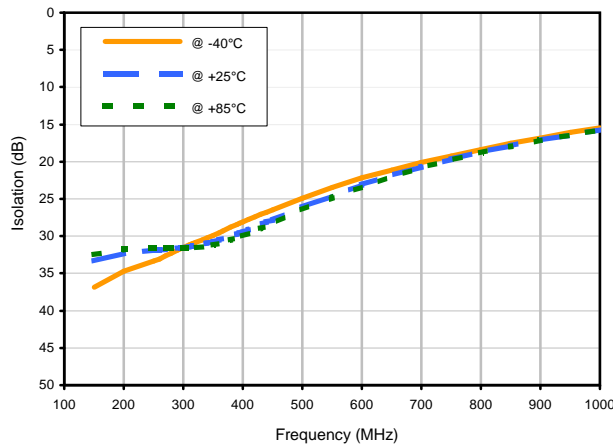

REV. X2
HPQ-04+
100621
Page 1 of 2



IF/RF MICROWAVE COMPONENTS • ISO 9001 ISO 14001 AS 9100 CERTIFIED RoHS compliant
P.O. Box 350166, Brooklyn, New York 11235-0003 (718) 934-4500 Fax (718) 332-4661



The Design Engineers Search Engine finds the model you need, Instantly • For detailed performance specs & shopping online see



Typical Performance Curves

VSWR

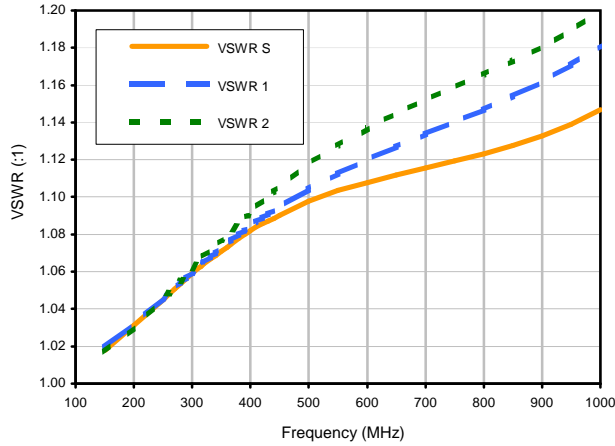

VSWR SUM vs. TEMPERATURE

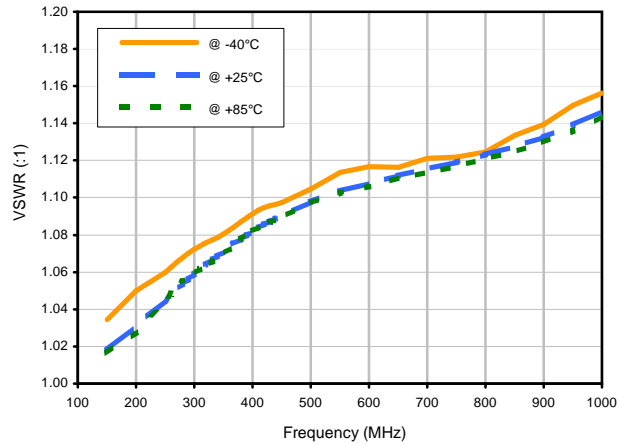

VSWR OUT1 vs. TEMPERATURE

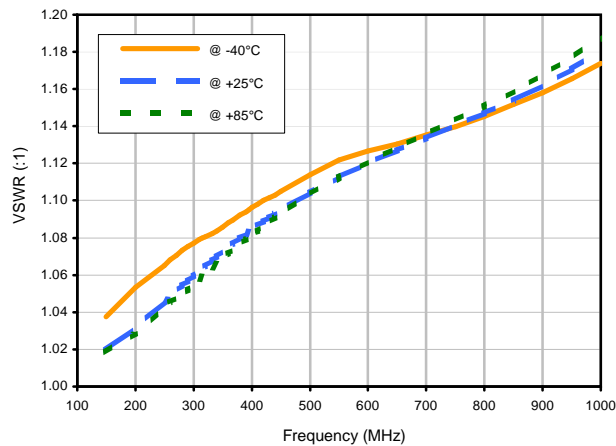

Outline Dimensions

AT577

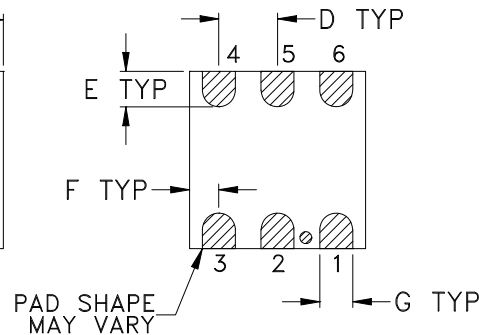
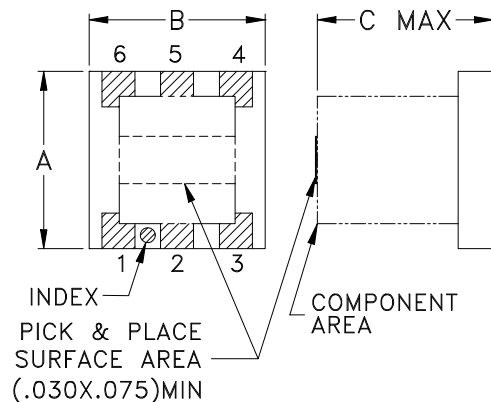

PCB Land Pattern

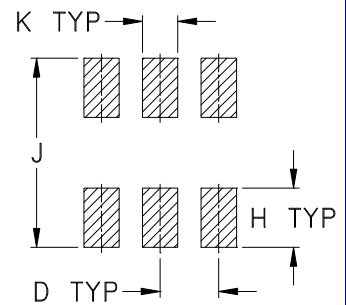

Suggested Layout,
Tolerance to be within $\pm .002$

CASE #	A	B	C	D	E	F	G	H	J	K	L	WT. GRAMS
AT577	.200 (5.08)	.200 (5.08)	.200 (5.08)	.075 (1.91)	.050 (1.27)	.025 (0.64)	.026 (0.66)	.070 (1.78)	.220 (5.59)	.035 (0.89)	-- --	.15

Dimensions are in inches (mm). Tolerances: 2 Pl. $\pm .01$; 3 Pl. $\pm .005$

Notes:

- Open style, ceramic base.
- Termination finish:
 - For RoHS Case Style: 2-10 μ inch (.05-.25 microns) Gold over 100-300 μ inch (2.54-7.62 microns) Nickel plate.
 - For RoHS-5 Case Style: Tin-Lead plate



P.O. Box 350186, Brooklyn, New York 11235-0003 (718) 934-4500 Fax (718) 332-4661 For detailed performance specs & shopping online see Mini-Circuits web site



The Design Engineers Search Engine Provides ACTUAL Data Instantly From MINI-CIRCUITS At: www.minicircuits.com

RF/IF MICROWAVE COMPONENTS

Tape & Reel Packaging TR-F73

DEVICE ORIENTATION IN T&R

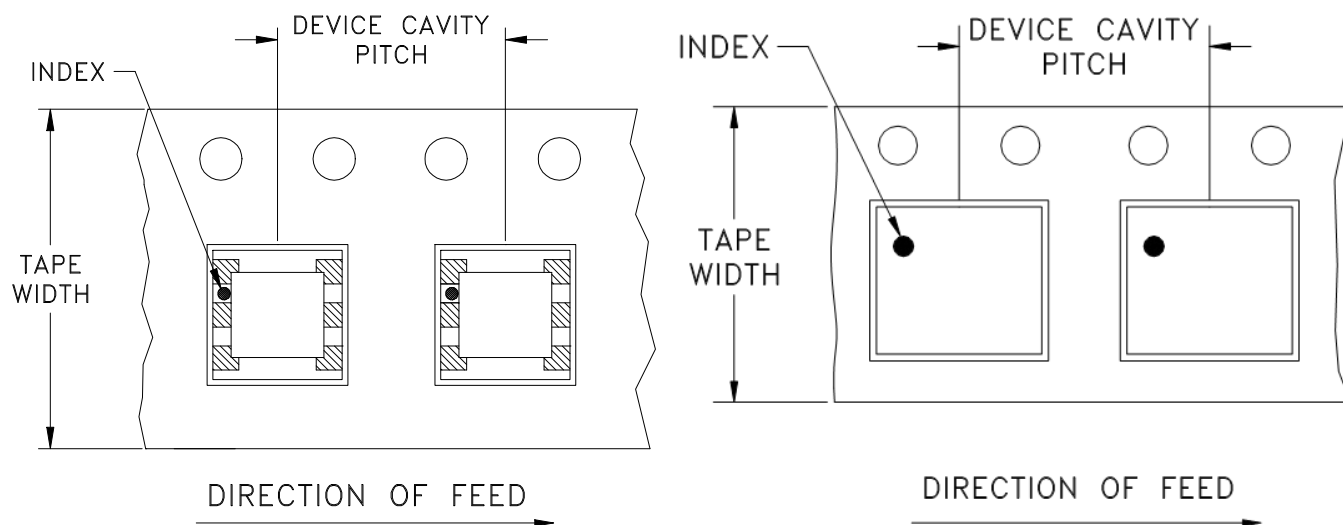

Tape Width, mm	Device Cavity Pitch, mm	Reel Size, inches	Devices per Reel	
12	8	7	Small quantity standards (see note)	20
				50
				100
				200
				500
		13	Standard	1000
		2000		

Note: Please Consult individual model data sheet to determine device per reel availability.

Mini-Circuits carrier tape materials provide protection from ESD (Electro-Static Discharge) during handling and transportation. Tapes are static dissipative and comply with industry standards EIA-481/EIA-541.

Go to: www.minicircuits.com/pages/pdfs/tape.pdf

Mini-Circuits[®]

INTERNET <http://www.minicircuits.com>

P.O. Box 350166, Brooklyn, New York 11235-0003 (718) 934-4500 Fax (718) 332-4661

Distribution Centers NORTH AMERICA 800-654-7949 • 417-335-5935 • Fax 417-335-5945 • EUROPE 44-1252-832600 • Fax 44-1252-837010

Mini-Circuits ISO 9001 & ISO 14001 Certified

THIRD ANGLE PROJECTION

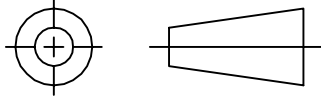

REVISIONS

REV	ECN No.	DESCRIPTION	DATE	DR	AUTH
OR	M83147	NEW RELEASE	11/26/02	MMG	HY
A	M102713	ADDED "...WITH SMOBC"	01/17/06	MMG	IL

**SUGGESTED MOUNTING CONFIGURATION
FOR AT577 CASE STYLE, "km" PIN CONNECTION**

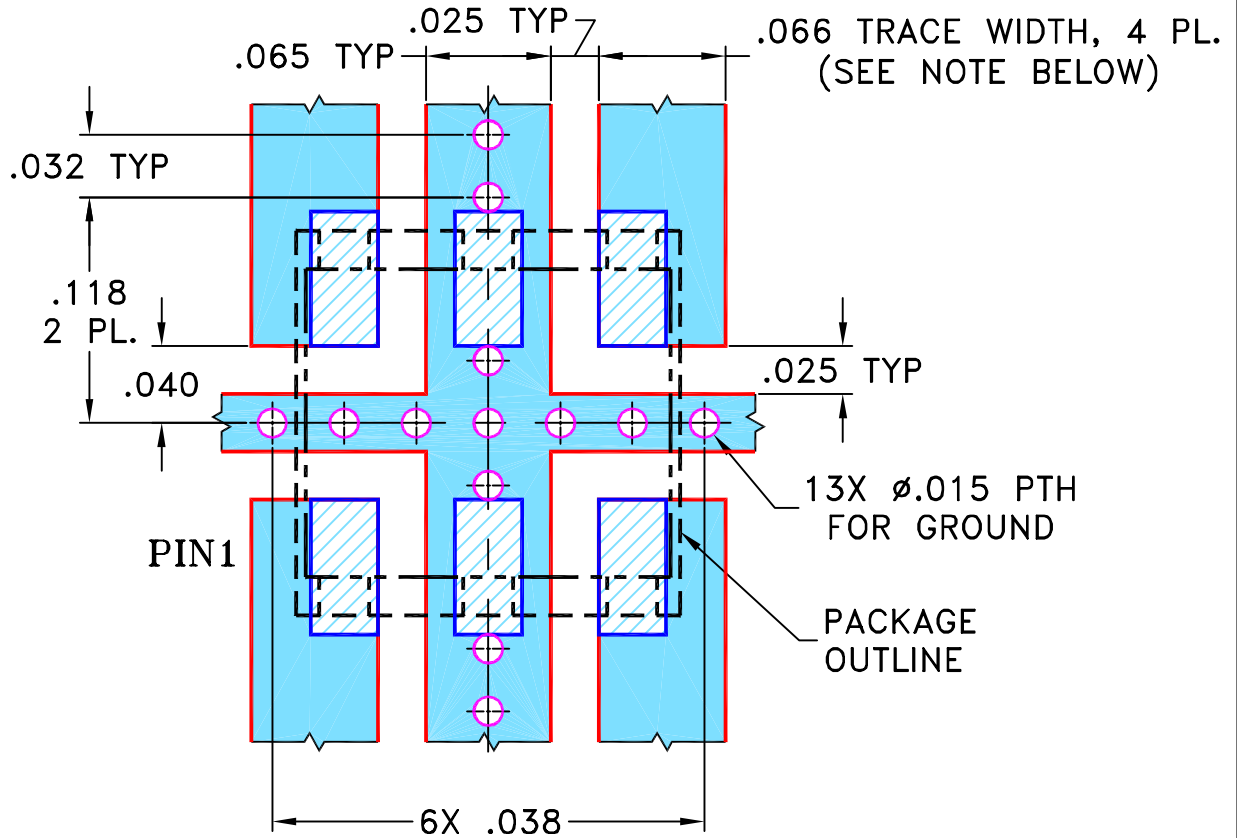

- NOTES:**
- TRACE WIDTH IS SHOWN FOR ROGERS R04350B WITH DIELECTRIC THICKNESS .030" ± .002"; COPPER: 1/2 OZ. EACH SIDE. FOR OTHER MATERIALS TRACE WIDTH MAY NEED TO BE MODIFIED.
 - BOTTOM SIDE OF THE PCB IS CONTINUOUS GROUND PLANE.

- DENOTES PCB COPPER LAYOUT WITH SMOBC (SOLDER MASK OVER BARE COPPER)
- DENOTES COPPER LAND PATTERN FREE OF SOLDER MASK

UNLESS OTHERWISE SPECIFIED	INITIALS	DATE
DRAWN	MMG	11/19/02
CHECKED	AV	11/25/02
APPROVED	HY	11/26/02

Mini-Circuits®
THIS DOCUMENT AND ITS CONTENTS ARE THE PROPERTY OF MINI-CIRCUITS. EXCEPT FOR USE EXPRESSLY GRANTED, IN WRITING, TO ITS VENDORS, VENDEE AND THE UNITED STATES GOVERNMENT, MINI-CIRCUITS RESERVES ALL PROPRIETARY DESIGN, USE, MANUFACTURING AND REPRODUCTION RIGHTS THERETO. THESE CONTENTS SHALL NOT BE USED, DUPLICATED OR DISCLOSED TO ANY OUTSIDE PARTY, IN WHOLE OR IN PART, WITHOUT WRITTEN PERMISSION OF MINI-CIRCUITS.

Mini-Circuits® 13 Neptune Avenue
Brooklyn NY 11235

PL, km, AT577, HPQ, TB-43

SIZE A	CODE IDENT 15542	DRAWING NO: 98-PL-114	REV: A
FILE:	98PL114	SCALE:	10:1
SHEET:		1 OF 1	

Evaluation Board and Circuit

For Pin Connection refer to Data Sheet of the DUT

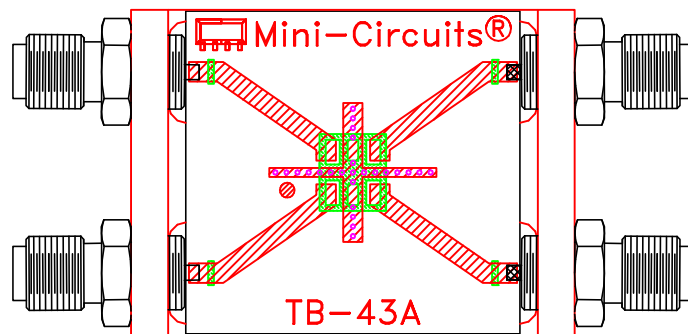

TB-43

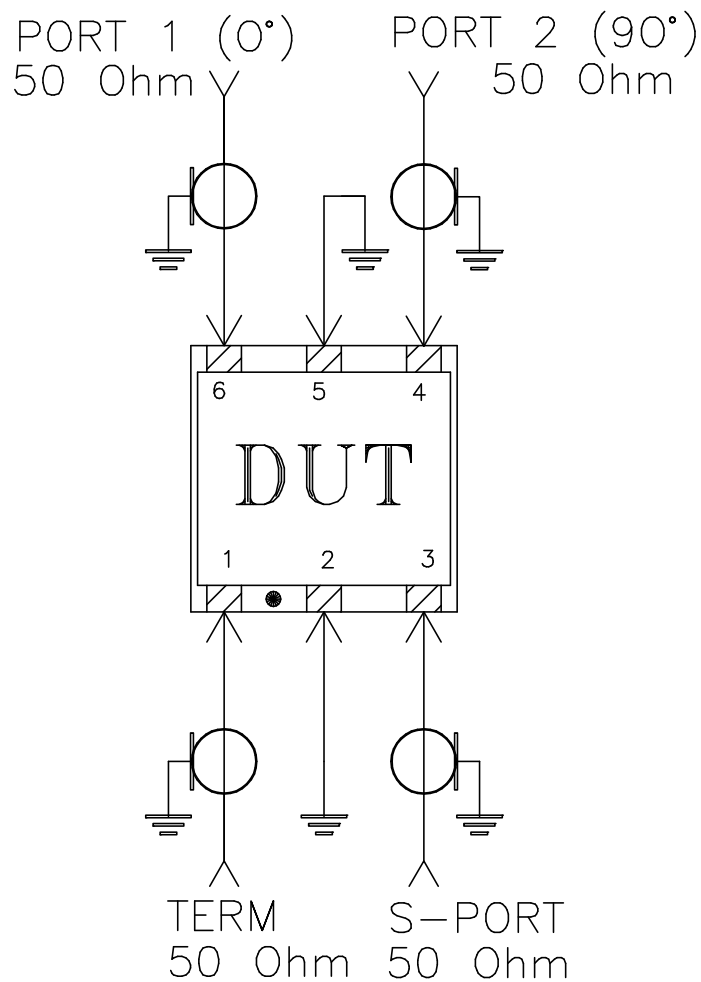

Schematic Diagram

Notes:

1. SMA Female connectors.
2. PCB Material: Rogers R04350 or equivalent,
Dielectric Constant=3.5, Thickness=.030 inch.

 Mini-Circuits®



All Mini-Circuits products are manufactured under exacting quality assurance and control standards, and are capable of meeting published specifications after being subjected to any or all of the following physical and environmental test.

Specification	Test/Inspection Condition	Reference/Spec
Operating Temperature	-40° to 85°C Ambient Environment	Individual Model Data Sheet
Storage Temperature	-55° to 100° C Ambient Environment	Individual Model Data Sheet
Humidity	90 to 95% RH, 240 hours, 50°C	MIL-STD-202, Method 103, Condition A, Except 50°C and end-point electrical test done within 12 hours
Thermal Shock	-55° to 100°C, 100 cycles	MIL-STD-202, Method 107, Condition A-3, except +100°C
Solder Reflow Heat	Sn-Pb Eutetic Process: 225°C peak Pb-Free Process 245° - 250°C peak	J-STD-020, Table 4-1, 4-2 and 5-2, Figure 5-1
Solderability	10X Magnification	J-STD-002, 95% Coverage
Vibration (High Frequency)	20g peak, 10-2000 Hz, 12 times in each of three perpendicular directions (total 36)	MIL-STD-202, Method 204, Condition D
Mechanical Shock	50g, 11 ms, 1/2-sine, 18 shocks: 3 each direction, each of 3 axes	MIL-STD-202, Method 213, Condition A
Marking Resistance to Solvents	Isopropyl alcohol + mineral spirits at 25°C; terpene defluxer at 25°C; distilled water + proylene glycol monomethyl ether + monoethanolamine at 63°C to 70°C	MIL-STD-202, Method 215