



CERAMIC

High Pass Filter

HFCW-133+

Mini-Circuits

50Ω 14200 to 20500 MHz

THE BIG DEAL

- Good rejection, 38 dB typ.
- Tiny size, 0603 (0.063" X 0.032" X 0.024")
- Good power handling, 2.5W



Generic photo used for illustration purposes only

CASE STYLE: JC0603C

+RoHS Compliant

The +Suffix identifies RoHS Compliance. See our web site for RoHS Compliance methodologies and qualifications

APPLICATIONS

- Test and Measurement Equipment
- EW, Radar and ECM Defense Systems
- Back Haul Radio Systems

PRODUCT OVERVIEW

HFCW-133+ is a high pass filter with passband from 14200 MHz to 20500 MHz supporting a variety of applications. This model provides good insertion loss over a wide band due to strategically constructed layout. Housed in a tiny 0603 ceramic form factor with wraparound terminations, the filter is ideal for dense PCB layouts.

KEY FEATURES

Feature	Advantages
Wide passband	This filter has a very wide passband from 14.2 GHz to 20.5 GHz.
LTCC Construction	Provides repeatable performance in a rugged, ceramic package well suited for tough environments such as high humidity and temperature extremes.
Small size, 0603 (0.063" X 0.032" X 0.024")	Saves space in dense circuit board layouts and minimizes the effects of parasitics.
Wrap-around terminations	Provides excellent solderability and easy visual inspection.

REV. A
ECO-015160
HFCW-133+
EDU4313
URJ
220924





CERAMIC

High Pass Filter

HFCW-133+

ELECTRICAL SPECIFICATIONS^{1,2} AT 25°C

Parameter		F#	Frequency (MHz)	Min.	Typ.	Max.	Units
Stopband	Rejection Loss	DC-F1	DC - 8500	28	34	—	dB
		F1-F2	8500 - 10200	24	38	—	dB
	Freq. Cut-Off	F3*	13300	—	3	—	dB
Passband	Insertion Loss	F4-F5	14200 - 16500	—	2.5	—	dB
		F5-F6	16500 - 19500	—	1.1	1.9	dB
		F6-F7	19500 - 20500	—	1.2	—	dB
	Return Loss	F4-F5	14200 - 16500	—	8	—	dB
		F5-F6	16500 - 19500	—	10	—	dB
		F6-F7	19500 - 20500	—	8	—	dB

1 This component should not be employed as a DC-block. DC de-coupling capacitors are required in Applications where DC voltage and/or current is present at either input or output ports. Please contact Mini-Circuits for further support.

2 Measured on Mini-Circuits Characterization Test Board TB-HFCW-133+

* Typically, a ±5% frequency deviation from the stated value may occur on a unit-to-unit basis.

MAXIMUM RATINGS

Parameter	Ratings
Operating temperature	-55°C to 125°C
Storage temperature	-55°C to 125°C
RF Power Input*	2.5W @25°C

*Passband rating, derate linearly to 0.6W at 125°C ambient
Permanent damage may occur if any of these limits are exceeded.

TYPICAL FREQUENCY RESPONSE

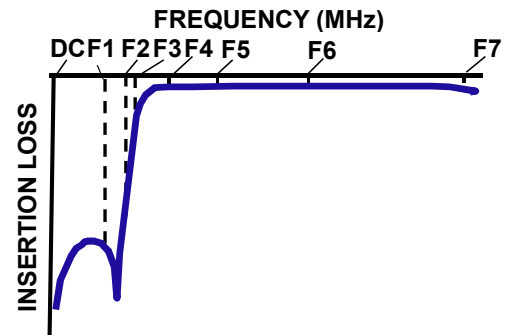

FUNCTIONAL SCHEMATIC

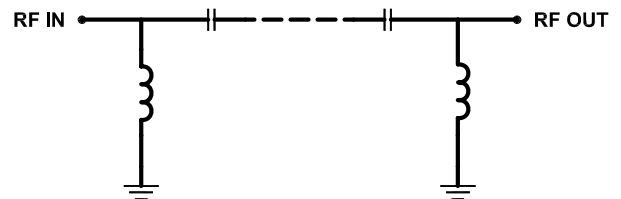



PAD CONNECTIONS

INPUT	1
OUTPUT	3
GROUND	2,4,5,6

PRODUCT MARKING: 8

DEMO BOARD MCL P/N: TB-HFCW-133+ SUGGESTED PCB LAYOUT (PL-704)

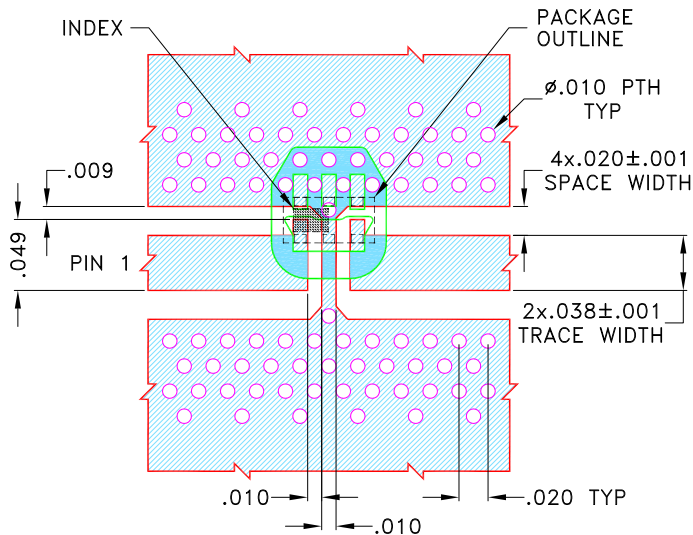

NOTES:

1. COPLANAR WAVEGUIDE PARAMETERS ARE SHOWN FOR ROGERS (R03003) WITH DIELECTRIC THICKNESS .020±.001 COPPER: 1/2 Oz. EACH SIDE. FOR OTHER MATERIALS TRACE WIDTH AND GAP MAY NEED TO BE MODIFIED.
 2. BOTTOM SIDE OF THE PCB IS CONTINUOUS GROUND PLANE.
- DENOTES PCB COPPER PATTERN WITH SMOBC (SOLDER MASK OVER BARE COPPER)
 DENOTES PCB COPPER PATTERN FREE OF SOLDERMASK

OUTLINE DRAWING

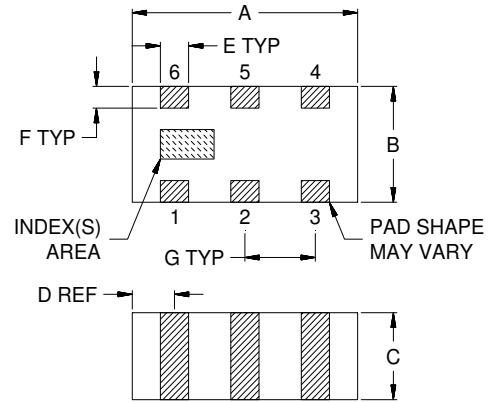

OUTLINE DIMENSIONS (Inches/mm)

A	B	C	D	E	F	G	Wt.
.063	.032	.024	.012	.008	.006	.020	grams
1.60	0.80	0.60	0.30	0.20	0.15	0.50	.005

Note: Please refer to case style drawing for details



CERAMIC

High Pass Filter

HFCW-133+

TYPICAL PERFORMANCE DATA AT 25°C

Frequency (MHz)	Insertion Loss (dB)	Return Loss (dB)
10	73.18	0.08
100	62.35	0.10
2000	39.39	0.13
8500	41.95	0.13
10200	39.81	0.28
11000	30.36	0.44
11900	20.18	0.86
13250	3.05	13.20
13300	2.78	15.80
14200	1.75	11.01
15500	1.19	14.15
16500	0.97	16.87
18000	0.78	15.91
19500	0.75	14.87
20500	0.76	13.18

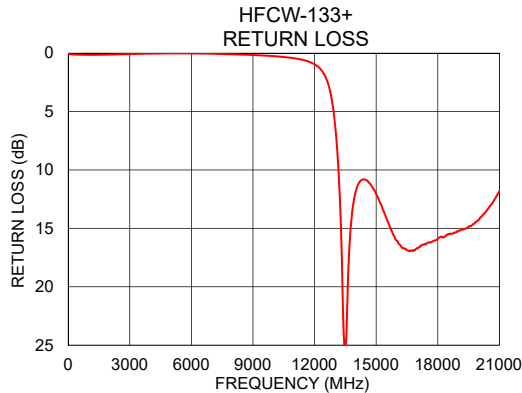
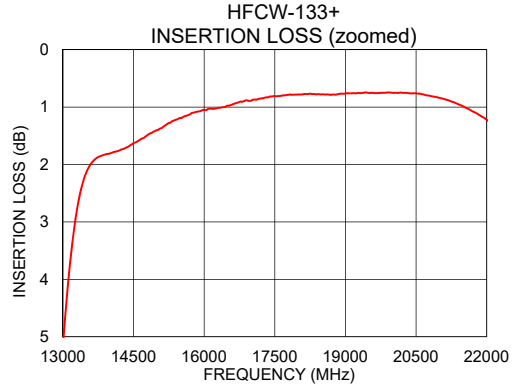
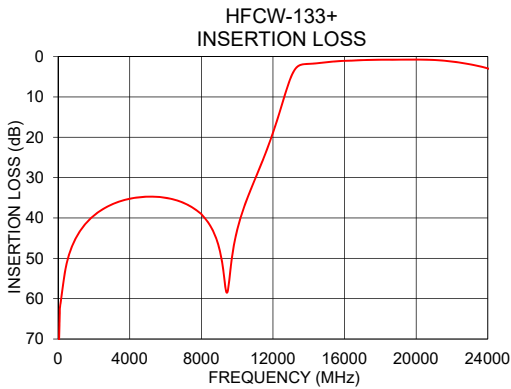

NOTES

- A. Performance and quality attributes and conditions not expressly stated in this specification document are intended to be excluded and do not form a part of this specification document.
- B. Electrical specifications and performance data contained in this specification document are based on Mini-Circuit's applicable established test performance criteria and measurement instructions.
- C. The parts covered by this specification document are subject to Mini-Circuits standard limited warranty and terms and conditions (collectively, "Standard Terms"); Purchasers of this part are entitled to the rights and benefits contained therein. For a full statement of the standard. Terms and the exclusive rights and remedies thereunder, please visit Mini-Circuits' website at www.minicircuits.com/MCLStore/terms.jsp



Typical Performance Data

FREQ. (MHz)	INSERTION LOSS			INPUT RETURN LOSS			OUTPUT RETURN LOSS		
	(dB)			(dB)			(dB)		
	@-55°C	@+25°C	@+125°C	@-55°C	@+25°C	@+125°C	@-55°C	@+25°C	@+125°C
10	74.55	73.18	75.98	0.06	0.08	0.10	0.06	0.09	0.10
100	62.35	62.35	62.39	0.07	0.10	0.12	0.07	0.10	0.12
300	55.83	55.86	55.91	0.08	0.12	0.15	0.08	0.12	0.15
500	50.87	50.91	50.94	0.09	0.13	0.17	0.09	0.14	0.17
700	47.90	47.93	47.95	0.09	0.14	0.18	0.10	0.15	0.19
900	45.75	45.78	45.80	0.09	0.14	0.19	0.10	0.16	0.19
1000	44.87	44.90	44.92	0.09	0.14	0.19	0.10	0.16	0.19
1500	41.57	41.60	41.61	0.08	0.14	0.19	0.09	0.15	0.19
2000	39.37	39.39	39.41	0.06	0.13	0.17	0.07	0.14	0.18
2500	37.78	37.82	37.83	0.03	0.11	0.16	0.04	0.12	0.16
3000	36.59	36.65	36.68	0.00	0.08	0.14	0.01	0.10	0.14
3500	35.73	35.81	35.85	0.03	0.06	0.12	0.01	0.08	0.12
4000	35.10	35.23	35.29	0.05	0.04	0.11	0.04	0.06	0.11
4500	34.72	34.87	34.96	0.07	0.03	0.10	0.06	0.05	0.10
5000	34.56	34.73	34.84	0.09	0.02	0.10	0.08	0.04	0.10
5500	34.55	34.75	34.89	0.10	0.02	0.10	0.09	0.04	0.10
6000	34.77	34.98	35.17	0.10	0.03	0.11	0.08	0.05	0.11
6500	35.23	35.48	35.66	0.09	0.04	0.13	0.07	0.06	0.13
7000	35.96	36.24	36.45	0.08	0.05	0.15	0.06	0.08	0.15
7500	37.06	37.40	37.64	0.06	0.07	0.18	0.04	0.10	0.18
8000	38.58	39.01	39.32	0.04	0.10	0.21	0.02	0.12	0.21
8500	41.29	41.95	42.47	0.02	0.13	0.25	0.01	0.14	0.25
9000	46.28	47.54	48.81	0.00	0.16	0.29	0.01	0.18	0.29
9800	49.23	47.24	45.46	0.05	0.23	0.38	0.05	0.24	0.35
10000	44.32	43.03	41.69	0.07	0.26	0.41	0.07	0.26	0.38
10200	40.85	39.81	38.70	0.08	0.28	0.44	0.08	0.28	0.40
11000	31.29	30.36	29.34	0.20	0.44	0.63	0.16	0.39	0.54
11900	21.58	20.18	18.63	0.50	0.86	1.22	0.40	0.72	1.00
12600	12.16	10.47	8.72	1.49	2.31	3.51	1.22	1.95	2.89
13000	6.37	5.15	4.15	3.92	6.14	9.66	3.32	5.14	7.61
13300	3.17	2.78	2.58	9.91	15.80	24.18	7.89	10.92	13.36
14200	1.48	1.75	1.87	10.94	11.01	11.39	10.19	10.31	10.70
14400	1.44	1.68	1.79	10.36	10.81	11.41	9.81	10.27	10.85
14600	1.39	1.59	1.70	10.32	11.00	11.74	9.85	10.51	11.28
14800	1.29	1.48	1.60	10.58	11.43	12.31	10.18	11.02	11.90
15000	1.20	1.40	1.51	11.12	12.06	12.98	10.72	11.72	12.63
15200	1.11	1.30	1.42	11.80	12.84	13.86	11.47	12.61	13.55
15400	1.03	1.22	1.33	12.61	13.70	14.69	12.35	13.63	14.49
15600	0.95	1.16	1.26	13.54	14.55	15.52	13.40	14.76	15.49
15800	0.86	1.09	1.22	14.48	15.41	16.24	14.54	15.95	16.64
16000	0.79	1.05	1.18	15.48	16.05	16.69	15.68	17.03	17.54
16200	0.74	1.03	1.16	16.28	16.51	16.84	16.86	18.17	18.56
16500	0.72	0.97	1.10	16.67	16.87	16.84	18.45	19.03	18.98
16700	0.67	0.92	1.07	16.88	16.92	16.55	18.76	18.77	18.81
17000	0.62	0.89	1.02	16.62	16.68	16.35	18.70	18.47	18.47
17200	0.59	0.85	0.99	16.37	16.46	16.14	18.32	18.00	18.18
17400	0.56	0.81	0.97	16.16	16.38	16.03	17.93	17.53	17.84
17600	0.53	0.81	0.94	15.97	16.19	15.90	17.57	17.32	17.59
17800	0.50	0.78	0.91	15.80	16.07	15.95	17.37	17.10	17.53
18000	0.49	0.78	0.91	15.60	15.91	15.79	17.23	17.01	17.34
18200	0.47	0.77	0.90	15.42	15.72	15.77	17.00	16.80	17.31
18400	0.47	0.78	0.89	15.32	15.64	15.70	17.08	16.71	17.16
18600	0.46	0.78	0.89	15.19	15.47	15.64	16.92	16.48	16.91
18800	0.46	0.78	0.89	15.01	15.36	15.57	16.68	16.31	16.67
19000	0.46	0.76	0.90	14.87	15.22	15.45	16.45	15.96	16.48
19200	0.45	0.76	0.90	14.75	15.10	15.30	16.25	15.77	16.13
19500	0.46	0.75	0.90	14.45	14.87	15.05	15.64	15.31	15.41
19700	0.43	0.76	0.91	14.30	14.66	14.71	15.13	14.82	14.85
20000	0.46	0.75	0.92	13.83	14.27	14.14	14.36	14.22	13.93
20500	0.47	0.76	0.99	12.88	13.18	12.79	12.82	12.82	12.25

Typical Performance Data

FREQ. (MHz)	GROUP DELAY		
	(nsec)		
	@-55°C	@+25°C	@+125°C
14200	0.19	0.18	0.17
14400	0.17	0.16	0.15
14600	0.16	0.15	0.14
14800	0.14	0.14	0.13
15000	0.13	0.13	0.12
15200	0.13	0.12	0.12
15400	0.12	0.11	0.11
15600	0.11	0.11	0.11
15800	0.11	0.10	0.10
16000	0.10	0.10	0.10
16200	0.10	0.09	0.09
16500	0.09	0.08	0.08
16600	0.09	0.08	0.08
16800	0.08	0.08	0.08
17000	0.08	0.08	0.08
17200	0.08	0.07	0.07
17400	0.08	0.07	0.07
17600	0.07	0.07	0.07
17800	0.07	0.07	0.07
18000	0.07	0.07	0.07
18100	0.07	0.06	0.07
18200	0.06	0.06	0.07
18300	0.06	0.06	0.06
18400	0.06	0.06	0.06
18500	0.06	0.06	0.06
18600	0.06	0.06	0.06
18700	0.06	0.06	0.06
18800	0.06	0.06	0.06
18900	0.06	0.06	0.06
19000	0.06	0.06	0.06
19100	0.06	0.06	0.06
19200	0.06	0.06	0.06
19300	0.06	0.06	0.06
19400	0.06	0.06	0.06
19500	0.06	0.06	0.06
19600	0.06	0.06	0.06
19700	0.06	0.05	0.06
20000	0.05	0.06	0.06
20300	0.06	0.06	0.06
20500	0.06	0.06	0.06

Typical Performance Curves

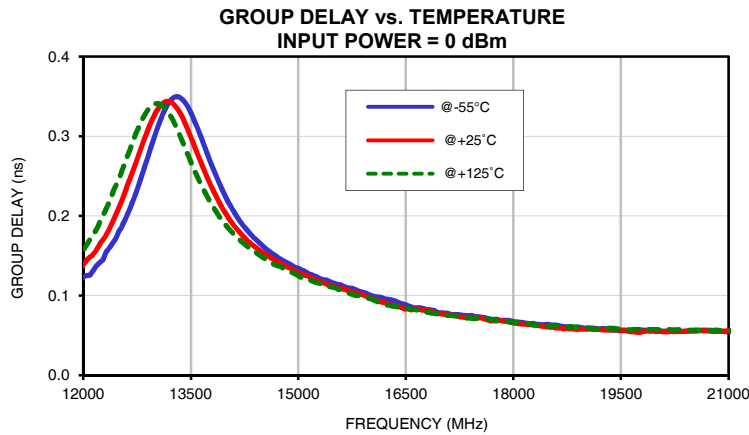
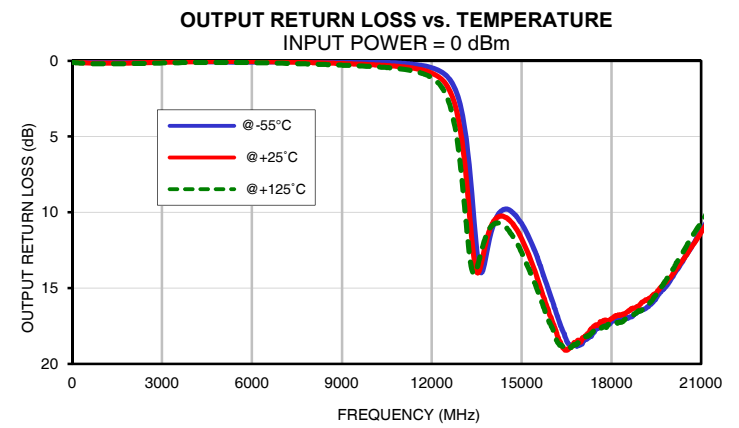
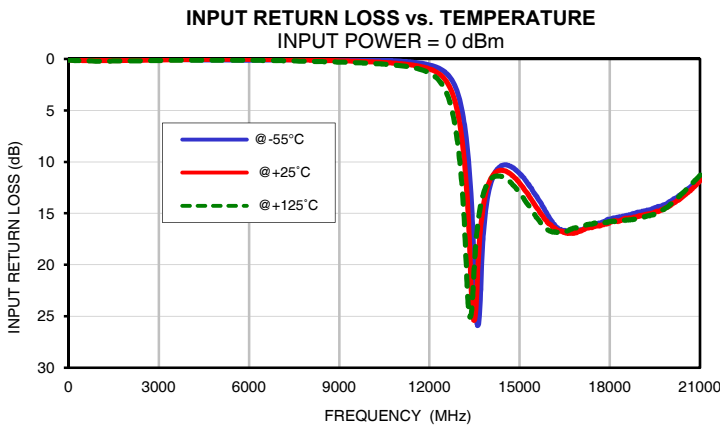
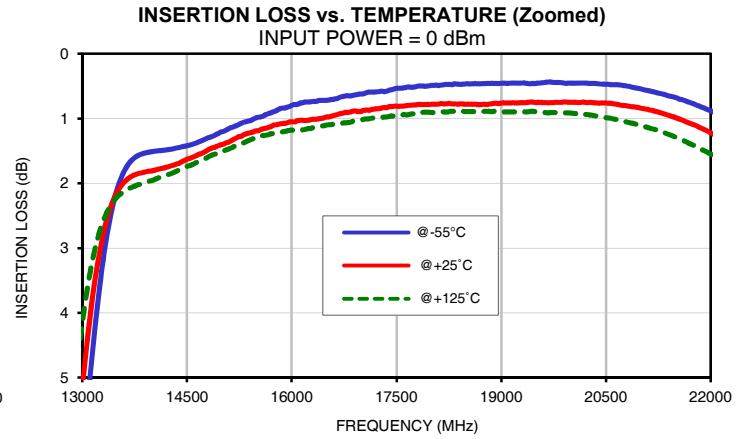
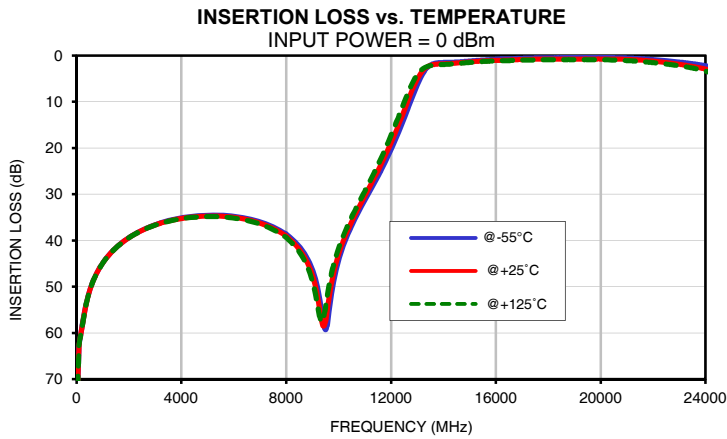

Outline Dimensions

JC0603C

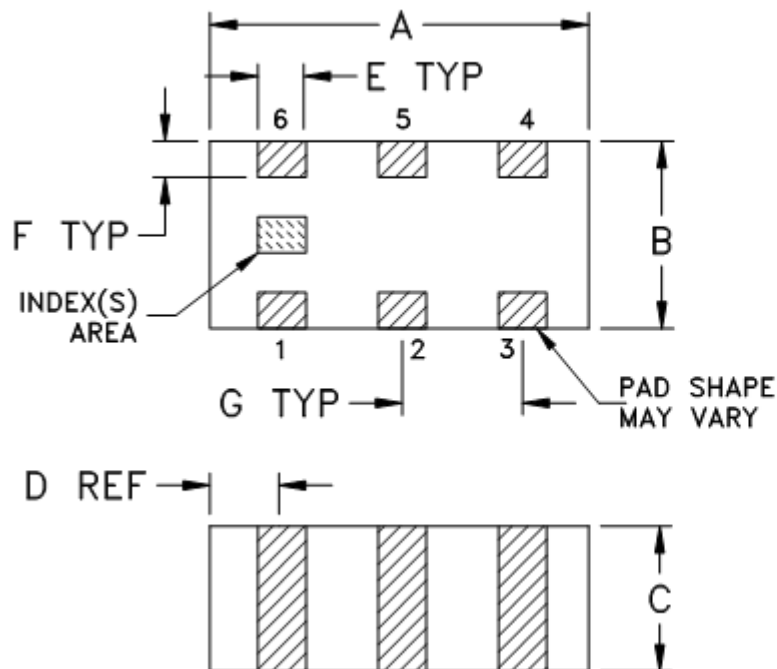

PCB Land Pattern

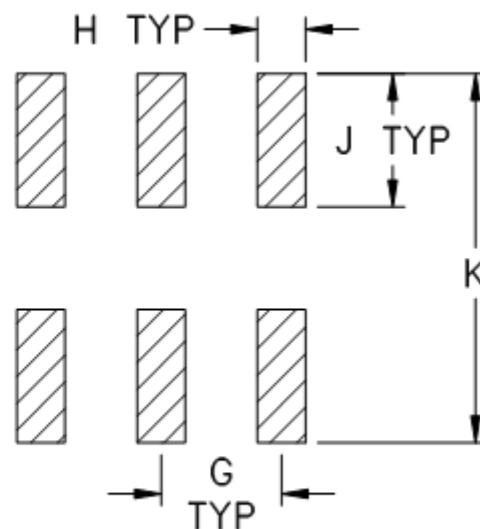

Suggested Layout,
Tolerance to be within $\pm .002$

CASE #	A	B	C	D	E	F	G	H	J	K	WT. GRAM
JC0603C	.063 (1.60)	.031 (0.80)	.024 (0.60)	.012 (0.30)	.008 (0.20)	.006 (0.15)	.020 (0.50)	.010 (0.25)	.022 (0.55)	0.053 (1.35)	.005

Dimensions are in inches (mm). Tolerances: 2 Pl. $\pm .01$; 3 Pl. $\pm .005$

Notes:

- Open style, ceramic base.
- Termination finish:
For RoHS Case Styles: Tin plate over Nickel plate. All models, (+) suffix.



P.O. Box 350166, Brooklyn, New York 11235-0003 (718) 934-4500 Fax (718) 332-4661 For detailed performance specs & shopping online see Mini-Circuits web site



The Design Engineers Search Engine Provides ACTUAL Data Instantly From MINI-CIRCUITS At: www.minicircuits.com

RF/IF MICROWAVE COMPONENTS

Tape & Reel Packaging TR-F114

DEVICE ORIENTATION IN T&R

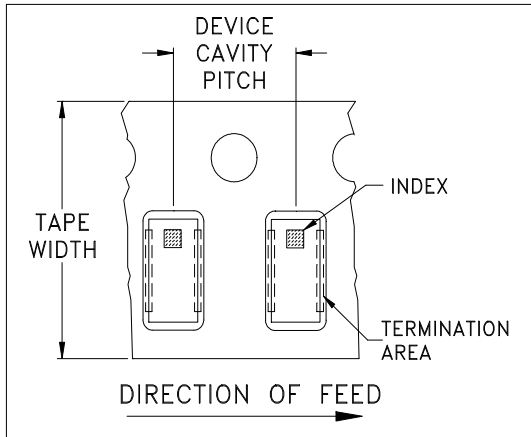

ILLUSTRATION 1

Applicable Case Styles	
GE0805C	JC0603C
GE0805C-1	JC0603C-4
GE0805C-1AP	JC0603C-6
GE0805C-7	
GE0805C-9	
GE0805C-10	
GE0805C-11	
GE0805C-12	

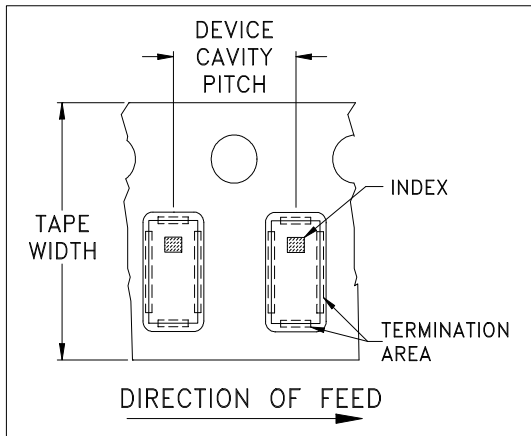

ILLUSTRATION 2

Applicable Case Styles	
GE0805C-2	JC0603C-1
GE0805C-3	JC0603C-2
GE0805C-4	JC0603C-3
GE0805C-5	JC0603C-5
GE0805C-6	JC0603C-7
GE0805C-8	JV1210C-1
GE0805C-15	

Tape Width, mm	Device Cavity Pitch, mm	Reel Size, inches	Devices per Reel	
8	4	7	Small quantity standards (see note)	20
				50
				100
				200
				500
				1000
			Standard	4000

Note: Please Consult individual model data sheet to determine device per reel availability.

Mini-Circuits carrier tape materials provide protection from ESD (Electro-Static Discharge) during handling and transportation. Tapes are static dissipative and comply with industry standards EIA-481/EIA-541.

Go to: www.minicircuits.com/pages/pdfs/tape.pdf



INTERNET <http://www.minicircuits.com>

P.O. Box 350166, Brooklyn, New York 11235-0003 (718) 934-4500 Fax (718) 332-4661

Distribution Centers NORTH AMERICA 800-654-7949 • 417-335-5935 • Fax 417-335-5945 • EUROPE 44-1252-832600 • Fax 44-1252-837010

Mini-Circuits ISO 9001 & ISO 14001 Certified

THIRD ANGLE PROJECTION

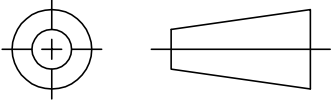

REVISIONS

REV	ECN No.	DESCRIPTION	DATE	DR	AUTH
OR	ECO-006344	NEW RELEASE	FEB 21	KKR	VC

SUGGESTED MOUNTING CONFIGURATION
FOR JC0603C CASE STYLE

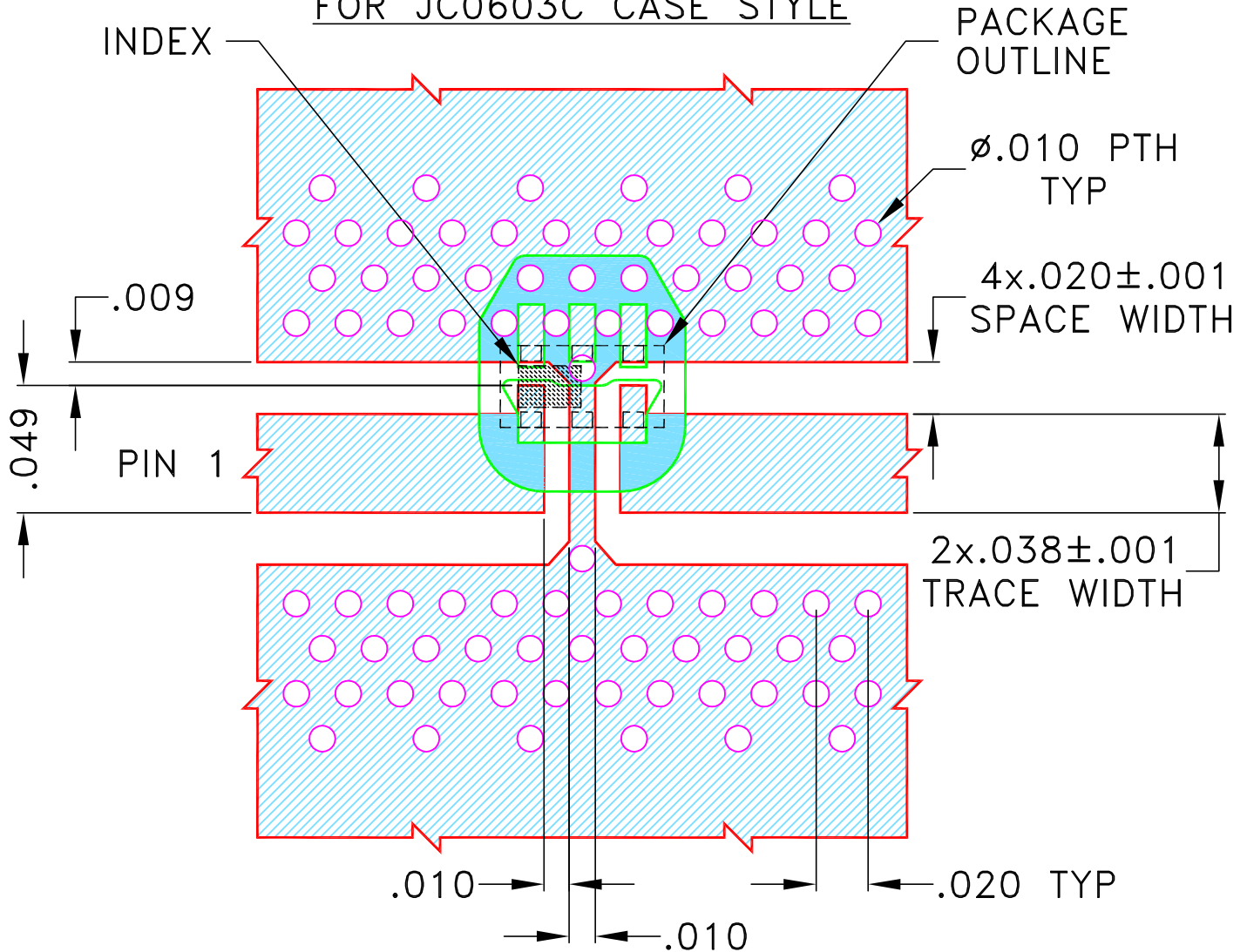

NOTES:

1. COPLANAR WAVEGUIDE PARAMETERS ARE SHOWN FOR ROGERS (R03003) WITH DIELECTRIC THICKNESS $.020 \pm .001$ COPPER: 1/2 Oz. EACH SIDE. FOR OTHER MATERIALS TRACE WIDTH AND GAP MAY NEED TO BE MODIFIED.
2. BOTTOM SIDE OF THE PCB IS CONTINUOUS GROUND PLANE.

DENOTES PCB COPPER PATTERN WITH SMOBC (SOLDER MASK OVER BARE COPPER)
 DENOTES PCB COPPER PATTERN FREE OF SOLDERMASK

UNLESS OTHERWISE SPECIFIED	INITIALS	DATE
DIMENSIONS ARE IN INCHES	DRAWN KKR	17 FEB 21
TOLERANCES ON:	CHECKED DDR	17 FEB 21
2 PL DECIMALS ±	APPROVED RV	17 FEB 21
3 PL DECIMALS ± .005		
ANGLES ±		
FRACTIONS ±		

Mini-Circuits[®] 13 Neptune Avenue
Brooklyn NY 11235

PL DWG, JC0603C C.S, 50 OHM, HFCW

Mini-Circuits [®]		SIZE	CODE IDENT	DRAWING NO:	REV:
THIS DOCUMENT AND ITS CONTENTS ARE THE PROPERTY OF MINI-CIRCUITS. EXCEPT FOR USE EXPRESSLY GRANTED, IN WRITING, TO ITS VENDORS, VENDEE AND THE UNITED STATES GOVERNMENT, MINI-CIRCUITS RESERVES ALL PROPRIETARY DESIGN, USE, MANUFACTURING AND REPRODUCTION RIGHTS THERETO. THESE CONTENTS SHALL NOT BE USED, DUPLICATED OR DISCLOSED TO ANY OUTSIDE PARTY, IN WHOLE OR IN PART, WITHOUT WRITTEN PERMISSION OF MINI-CIRCUITS.		A	15542	98-PL-704	OR
ASHEETA1.DWG REV:A DATE:01/12/95		FILE:	98PL704	SCALE:	15:1
		SHEET:	1	OF	1

Evaluation Board and Circuit

TB-HFCW-133+

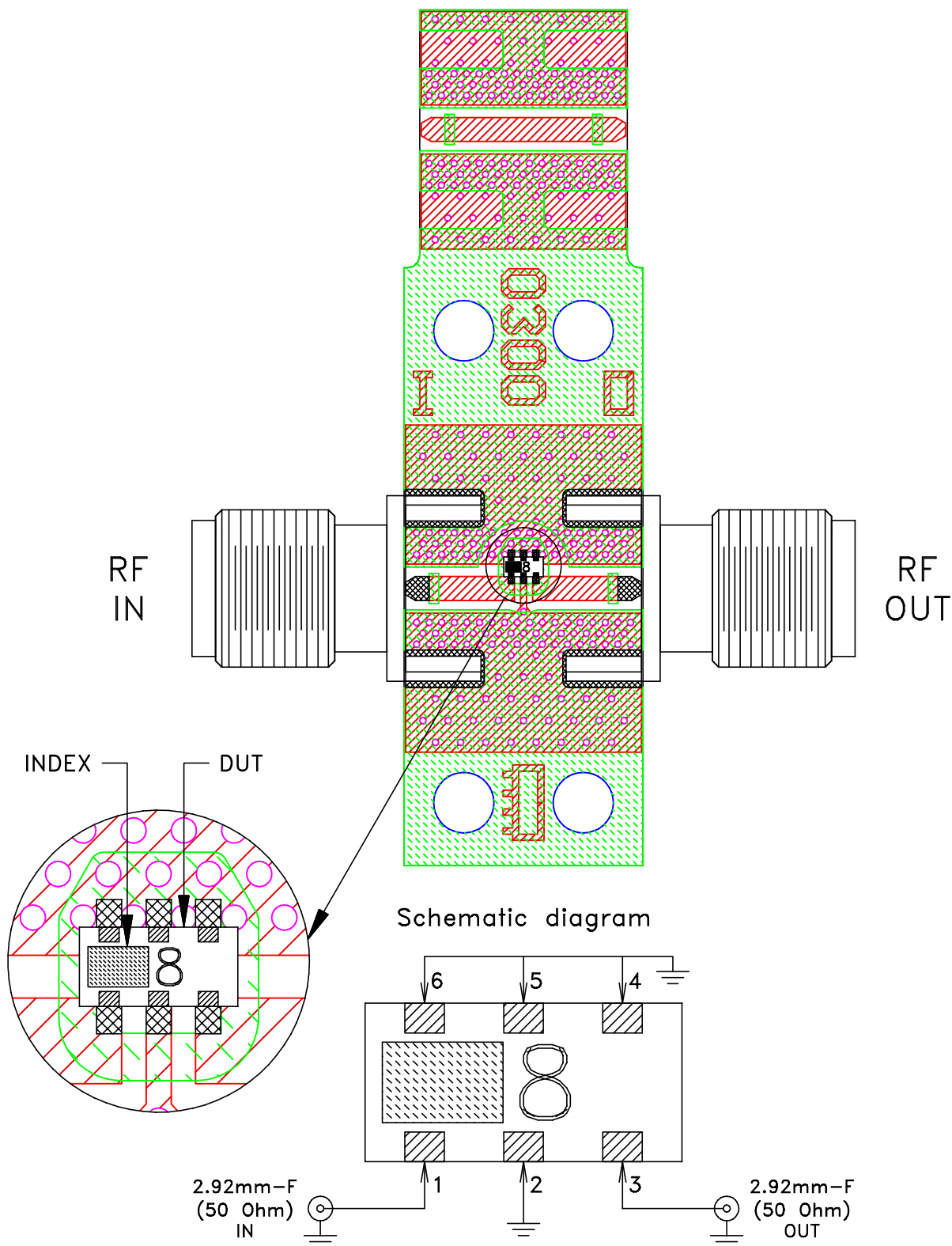

Notes:

1. PCB Material: ROGERS (R03003) OR Equivalent, Dielectric Constant= 3.00 ± 0.04
Dielectric Thickness: $.020 \pm 0.001$
2. 50 Ohm 2.92mm Female Connectors.
3. Connectors on the test board shall not be subjected to temperature greater than 200°C to avoid permanent damage to the connectors.

 **Mini-Circuits®**

All Mini-Circuits products are manufactured under exacting quality assurance and control standards, and are capable of meeting published specifications after being subjected to any or all of the following physical and environmental test.

Specification	Test/Inspection Condition	Reference/Spec
Operating Temperature	-55° to 125° C Ambient Environment	Individual Model Data Sheet
Storage Temperature	-55° to 125° C Ambient Environment	Individual Model Data Sheet
Humidity	90 to 95% RH, 240 hours, 50°C	MIL-STD-202, Method 103, Condition A, Except 50°C and end-point electrical test done within 12 hours
Solder Reflow Heat	Sn-Pb Eutectic Process 225°C peak Pb-Free Process 245° - 250°C peak	J-STD-020C, Table 4-1, 4-2 and 5-2, Figure 5-1
Solderability	10X Magnification	J-STD-002, Para 4.2.5, Test S, 95% Coverage
Vibration (High Frequency)	20g peak, 10-2000 Hz, 12 times in each of three perpendicular directions (total 36)	MIL-STD-202, Method 204, Condition D
Mechanical Shock	50g, 11 ms, 1/2-sine, 18 shocks: 3 each direction, each of 3 axes	MIL-STD-202, Method 213, Condition A