



CERAMIC

# High Pass Filter

## HFCW-1042+

50Ω 11500 to 20000 MHz

### THE BIG DEAL

- Good rejection, 34 dB typ.
- Tiny size, 0603 (0.063" X 0.032" X 0.024")
- Good power handling, 2.5W



Generic photo used for illustration purposes only

CASE STYLE: JC0603C

#### +RoHS Compliant

The +Suffix identifies RoHS Compliance. See our web site for RoHS Compliance methodologies and qualifications

### APPLICATIONS

- Test and Measurement Equipment
- Radar, EW, and ECM Defense System
- Broadband Telecommunication

### PRODUCT OVERVIEW

HFCW-1042+ is a high pass filter with passband from 11500 MHz to 20000 MHz supporting a variety of applications. This model provides good insertion loss over a wide band due to strategically constructed layout. Housed in a tiny 0603 ceramic form factor with wraparound terminations, the filter is ideal for dense PCB layouts.

### KEY FEATURES

Feature	Advantages
Ultra-wide stopband	This filter has a very wide passband from 11.5 GHz to 20 GHz.
LTCC Construction	Provides repeatable performance in a rugged, ceramic package well suited for tough environments such as high humidity and temperature extremes.
Small size, 0603 (0.063" X 0.032" X 0.024")	Saves space in dense circuit board layouts and minimizes the effects of parasitics.
Wrap-around terminations	Provides excellent solderability and easy visual inspection.

REV. A  
ECO-015160  
HFCW-1042+  
EDU4287  
URJ  
220924





CERAMIC

# High Pass Filter

## HFCW-1042+

### ELECTRICAL SPECIFICATIONS<sup>1,2</sup> AT 25°C

Parameter		F#	Frequency (MHz)	Min.	Typ.	Max.	Units
Stopband	Rejection Loss	DC-F1	DC - 7000	30	34	—	dB
		F1-F2	7000 - 8600	23	29	—	dB
	Freq. Cut-Off	F3*	10600	—	3.0	—	dB
Passband	Insertion Loss	F4-F5	11500 - 14000	—	2.0	—	dB
		F5-F6	14000 - 18500	—	1.0	1.8	dB
		F6-F7	18500 - 20000	—	2.0	—	dB
	Return Loss	F4-F5	11500 - 14000	—	11	—	dB
		F5-F6	14000 - 18500	—	14	—	dB
		F6-F7	18500 - 20000	—	9	—	dB

1 This component should not be employed as a DC-block. DC de-coupling capacitors are required in Applications where DC voltage and/or current is present at either input or output ports. Please contact Mini-Circuits for further support.

2 Measured on Mini-Circuits Characterization Test Board TB-HFCW-1042+

\* Typically, a ±5% frequency deviation from the stated value may occur on a unit-to-unit basis.

### MAXIMUM RATINGS

Parameter	Ratings
Operating temperature	-55°C to 125°C
Storage temperature	-55°C to 125°C
RF Power Input*	2.5W @25°C

\*Passband rating, derate linearly to 0.6W at 125°C ambient  
Permanent damage may occur if any of these limits are exceeded.

### TYPICAL FREQUENCY RESPONSE

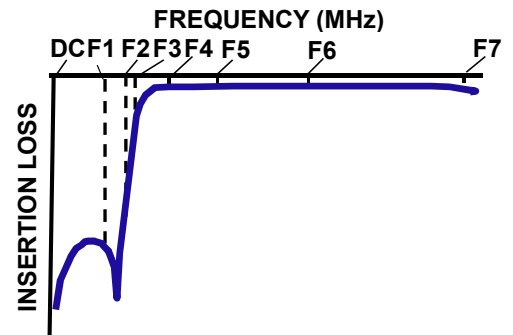

### FUNCTIONAL SCHEMATIC

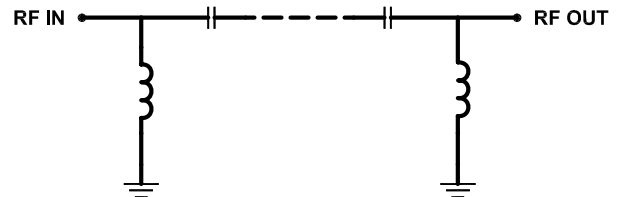



### PAD CONNECTIONS

INPUT	1
OUTPUT	3
GROUND	2,4,5,6

PRODUCT MARKING: 7

### DEMO BOARD MCL P/N: TB-HFCW-1042+ SUGGESTED PCB LAYOUT (PL-704)

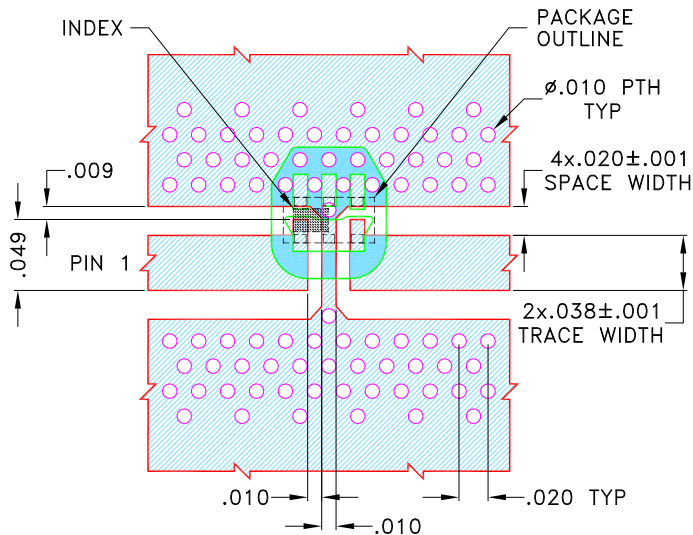

#### NOTES:

1. COPLANAR WAVEGUIDE PARAMETERS ARE SHOWN FOR ROGERS (R03003) WITH DIELECTRIC THICKNESS  $.020 \pm .001$  COPPER: 1/2 Oz. EACH SIDE. FOR OTHER MATERIALS TRACE WIDTH AND GAP MAY NEED TO BE MODIFIED.
  2. BOTTOM SIDE OF THE PCB IS CONTINUOUS GROUND PLANE.
- DENOTES PCB COPPER PATTERN WITH SMOBC (SOLDER MASK OVER BARE COPPER)  
 DENOTES PCB COPPER PATTERN FREE OF SOLDERMASK

### OUTLINE DRAWING

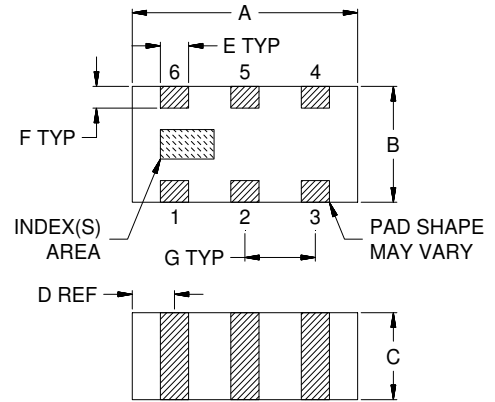

### OUTLINE DIMENSIONS (Inches/mm)

A	B	C	D	E	F	G	Wt.
<b>.063</b>	<b>.032</b>	<b>.024</b>	<b>.012</b>	<b>.008</b>	<b>.006</b>	<b>.020</b>	grams
1.60	0.80	0.60	0.30	0.20	0.15	0.50	.005

Note: Please refer to case style drawing for details



CERAMIC

# High Pass Filter

## HFCW-1042+

### TYPICAL PERFORMANCE DATA

Frequency (MHz)	Insertion Loss (dB)	Return Loss (dB)
10	77.16	0.09
100	62.16	0.10
2000	39.31	0.15
4000	35.97	0.08
7000	43.62	0.17
8600	37.23	0.39
9000	30.84	0.51
9600	20.45	0.92
10600	3.11	10.63
11500	1.34	15.86
12000	1.04	18.09
14000	0.72	16.89
15000	0.61	17.87
18500	0.36	21.74
20000	0.39	17.77

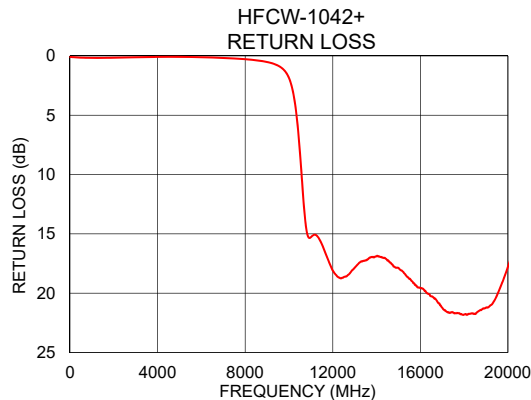
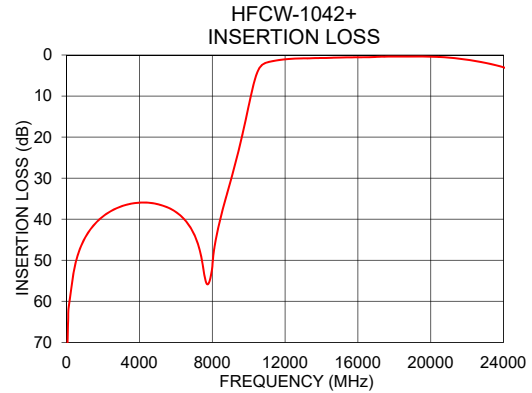
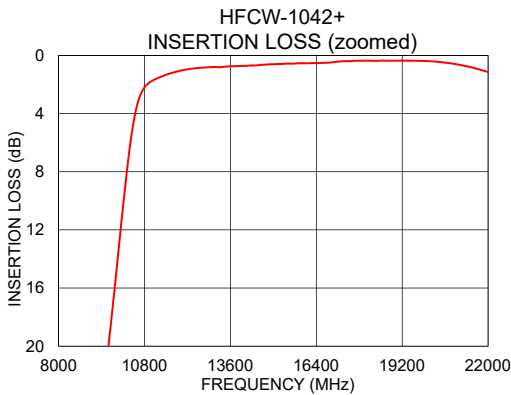

#### NOTES

- A. Performance and quality attributes and conditions not expressly stated in this specification document are intended to be excluded and do not form a part of this specification document.
- B. Electrical specifications and performance data contained in this specification document are based on Mini-Circuit's applicable established test performance criteria and measurement instructions.
- C. The parts covered by this specification document are subject to Mini-Circuits standard limited warranty and terms and conditions (collectively, "Standard Terms"); Purchasers of this part are entitled to the rights and benefits contained therein. For a full statement of the standard. Terms and the exclusive rights and remedies thereunder, please visit Mini-Circuits' website at [www.minicircuits.com/MCLStore/terms.jsp](http://www.minicircuits.com/MCLStore/terms.jsp)



Typical Performance Data

FREQ.  (MHz)	INSERTION LOSS			INPUT RETURN LOSS			OUTPUT RETURN LOSS		
	(dB)			(dB)			(dB)		
	@-55°C	@+25°C	@+125°C	@-55°C	@+25°C	@+125°C	@-55°C	@+25°C	@+125°C
10	74.53	77.16	76.05	0.07	0.09	0.11	0.07	0.09	0.11
100	62.09	62.16	62.09	0.07	0.10	0.14	0.07	0.10	0.13
300	55.57	55.58	55.59	0.09	0.12	0.17	0.09	0.12	0.16
500	50.59	50.61	50.66	0.10	0.14	0.19	0.11	0.14	0.18
700	47.63	47.65	47.69	0.11	0.15	0.21	0.11	0.15	0.20
900	45.50	45.52	45.56	0.11	0.16	0.21	0.11	0.16	0.21
1100	43.85	43.87	43.90	0.12	0.16	0.22	0.11	0.16	0.21
1300	42.52	42.53	42.57	0.11	0.16	0.22	0.11	0.16	0.21
1500	41.40	41.42	41.45	0.11	0.16	0.21	0.11	0.16	0.21
1700	40.46	40.48	40.51	0.10	0.16	0.21	0.10	0.16	0.20
1900	39.65	39.67	39.71	0.10	0.15	0.20	0.10	0.15	0.20
2100	38.96	38.98	39.02	0.09	0.15	0.20	0.09	0.15	0.19
2300	38.36	38.38	38.43	0.08	0.14	0.19	0.08	0.14	0.19
2500	37.84	37.87	37.92	0.07	0.13	0.18	0.07	0.13	0.18
2700	37.39	37.42	37.48	0.06	0.12	0.18	0.06	0.12	0.18
2900	37.00	37.04	37.10	0.05	0.12	0.17	0.05	0.11	0.17
3000	36.83	36.88	36.94	0.04	0.11	0.17	0.05	0.11	0.17
3200	36.53	36.60	36.67	0.03	0.11	0.16	0.04	0.10	0.16
3300	36.40	36.47	36.55	0.03	0.10	0.16	0.03	0.10	0.16
3600	36.09	36.18	36.27	0.01	0.09	0.15	0.02	0.09	0.15
3800	35.95	36.05	36.16	0.01	0.09	0.15	0.01	0.08	0.15
4400	35.81	35.95	36.12	0.01	0.08	0.15	0.01	0.07	0.14
4500	35.84	35.98	36.16	0.01	0.08	0.15	0.01	0.07	0.14
4600	35.87	36.02	36.21	0.02	0.08	0.15	0.02	0.07	0.14
4800	35.98	36.15	36.36	0.02	0.08	0.15	0.02	0.07	0.14
5000	36.16	36.34	36.55	0.02	0.08	0.16	0.02	0.07	0.15
6000	37.94	38.23	38.56	0.01	0.11	0.20	0.01	0.10	0.19
7000	42.99	43.62	44.21	0.04	0.17	0.28	0.05	0.17	0.28
7500	50.18	51.74	53.01	0.08	0.21	0.34	0.09	0.22	0.35
7800	56.62	55.65	53.86	0.11	0.25	0.39	0.12	0.26	0.40
8000	54.71	51.83	48.95	0.13	0.27	0.42	0.14	0.28	0.44
8500	40.22	38.92	37.38	0.20	0.36	0.55	0.23	0.40	0.58
8600	38.48	37.23	35.70	0.21	0.39	0.58	0.25	0.42	0.62
8800	35.23	34.01	32.48	0.25	0.44	0.65	0.30	0.49	0.70
9000	32.13	30.84	29.22	0.30	0.51	0.74	0.36	0.57	0.81
9500	23.99	22.33	20.33	0.51	0.81	1.16	0.61	0.94	1.33
9600	22.21	20.45	18.38	0.58	0.92	1.32	0.70	1.07	1.52
9800	18.48	16.54	14.34	0.79	1.24	1.83	0.95	1.47	2.14
9900	16.50	14.50	12.29	0.95	1.49	2.25	1.15	1.78	2.66
10000	14.47	12.43	10.26	1.16	1.86	2.86	1.41	2.22	3.41
10600	3.68	3.11	2.80	7.44	10.63	13.99	9.75	15.89	26.76
11000	1.67	1.81	1.92	14.41	15.28	16.14	20.22	17.94	16.98
11500	1.21	1.34	1.45	13.77	15.86	18.43	13.82	15.61	17.51
11800	1.01	1.15	1.27	15.02	17.24	20.13	14.83	16.89	19.37
12200	0.80	0.96	1.12	16.99	18.58	20.66	16.94	18.69	21.26
12600	0.68	0.86	1.02	18.01	18.58	19.68	18.59	19.52	21.61
13000	0.62	0.80	0.94	17.94	17.85	18.59	19.11	19.25	20.50
13500	0.57	0.76	0.88	17.53	17.24	17.28	18.96	18.87	18.72
14000	0.56	0.72	0.84	16.98	16.89	16.60	18.46	18.49	17.76
14500	0.50	0.67	0.80	17.38	17.25	16.61	19.05	18.92	17.80
15000	0.44	0.61	0.77	17.93	17.87	17.01	19.62	19.34	18.41
15500	0.38	0.56	0.76	18.98	18.80	17.77	20.89	20.16	19.68
16000	0.34	0.54	0.74	19.94	19.57	18.52	22.66	21.72	21.24
16500	0.32	0.52	0.67	20.57	20.27	19.40	24.36	23.19	21.96
17000	0.28	0.46	0.60	21.26	21.23	20.14	25.21	23.56	21.60
17500	0.20	0.40	0.56	21.95	21.64	20.54	24.30	22.88	21.27
18000	0.17	0.37	0.54	22.00	21.80	20.96	23.47	22.27	21.00
18500	0.15	0.36	0.54	22.05	21.74	21.98	22.93	21.90	21.17
19000	0.16	0.37	0.53	21.72	21.21	22.44	22.30	21.18	20.60
20000	0.16	0.39	0.61	18.45	17.77	16.79	17.66	16.76	15.42

## Typical Performance Data

FREQ.  (MHz)	GROUP DELAY		
	(nsec)		
	@-55°C	@+25°C	@+125°C
11500	0.22	0.21	0.20
11700	0.20	0.19	0.18
11900	0.18	0.17	0.16
12100	0.16	0.16	0.15
12300	0.15	0.14	0.14
12500	0.14	0.13	0.13
12700	0.13	0.12	0.12
12900	0.12	0.11	0.11
13100	0.11	0.11	0.10
13300	0.10	0.10	0.10
13500	0.10	0.09	0.09
13700	0.09	0.09	0.09
13900	0.09	0.08	0.08
14100	0.08	0.08	0.08
14300	0.08	0.08	0.08
14500	0.07	0.07	0.07
14700	0.07	0.07	0.07
14900	0.07	0.07	0.07
15100	0.07	0.07	0.07
15300	0.06	0.06	0.06
15500	0.06	0.06	0.06
15700	0.06	0.06	0.06
15900	0.06	0.06	0.06
16100	0.06	0.06	0.06
16300	0.06	0.05	0.05
16500	0.05	0.05	0.05
16700	0.05	0.05	0.05
16900	0.05	0.05	0.05
17100	0.05	0.05	0.05
17300	0.05	0.05	0.05
17500	0.05	0.05	0.05
17700	0.05	0.05	0.05
17900	0.05	0.05	0.05
18100	0.05	0.05	0.05
18300	0.05	0.05	0.05
18500	0.05	0.05	0.05
18700	0.05	0.05	0.05
18900	0.05	0.05	0.05
19000	0.05	0.05	0.05
20000	0.05	0.05	0.05

## Typical Performance Curves

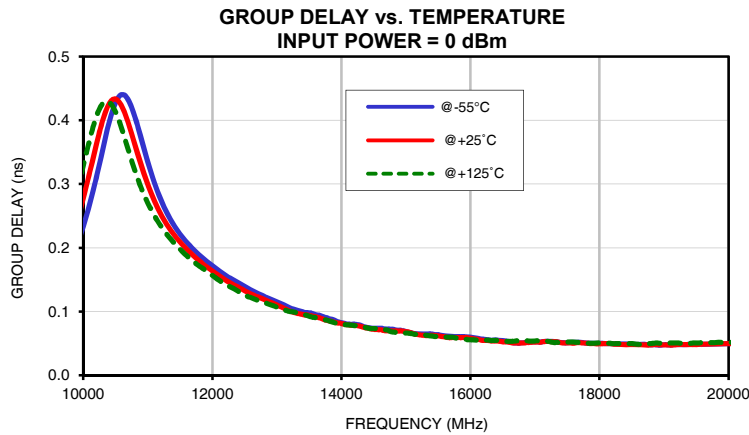
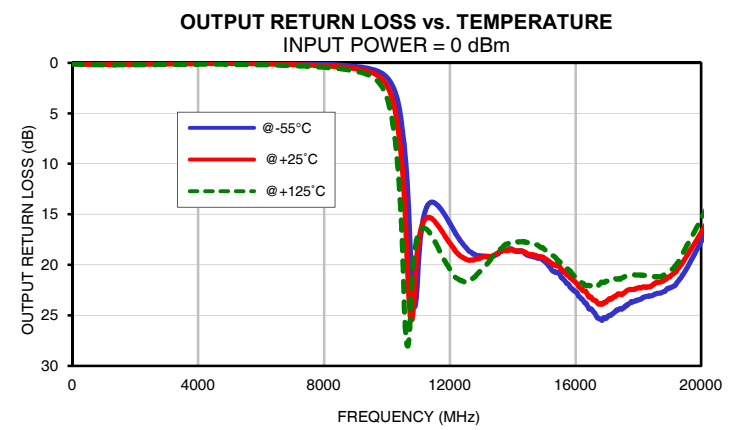
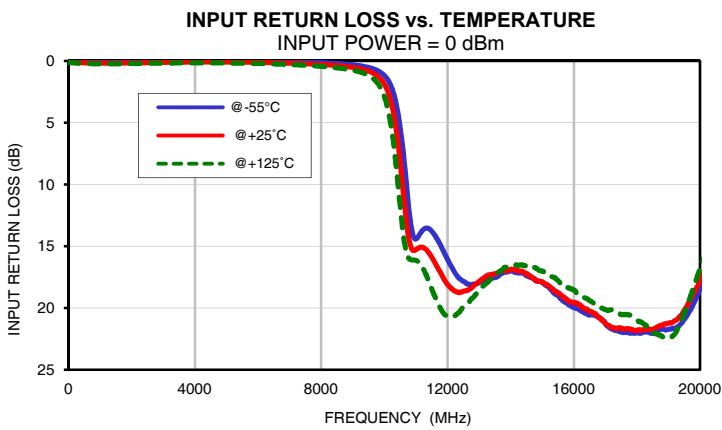
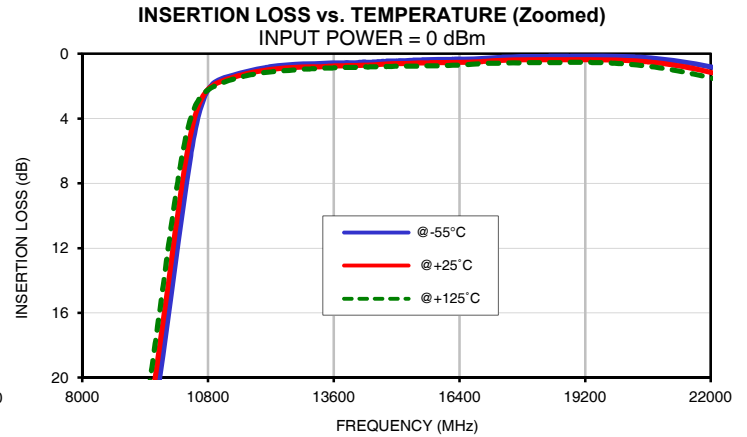
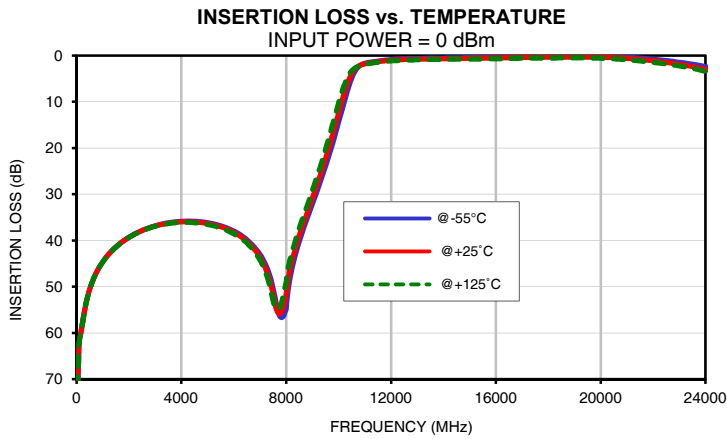



# Tape & Reel Packaging TR-F114

## DEVICE ORIENTATION IN T&R

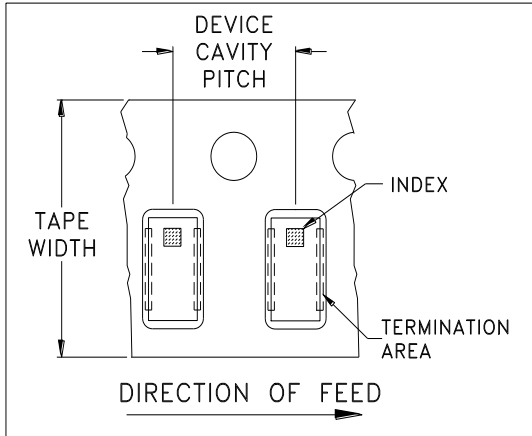

ILLUSTRATION 1

Applicable Case Styles	
GE0805C	JC0603C
GE0805C-1	JC0603C-4
GE0805C-1AP	JC0603C-6
GE0805C-7	
GE0805C-9	
GE0805C-10	
GE0805C-11	
GE0805C-12	

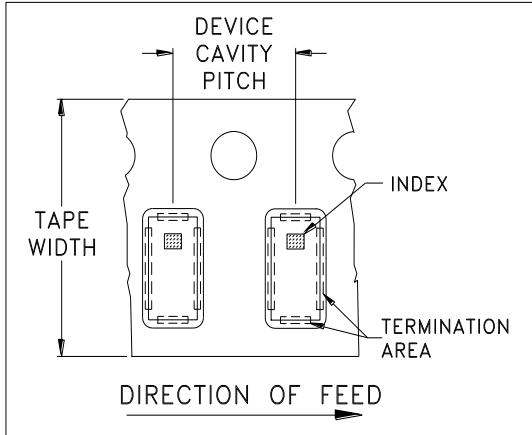

ILLUSTRATION 2

Applicable Case Styles	
GE0805C-2	JC0603C-1
GE0805C-3	JC0603C-2
GE0805C-4	JC0603C-3
GE0805C-5	JC0603C-5
GE0805C-6	JC0603C-7
GE0805C-8	
GE0805C-15	

Tape Width, mm	Device Cavity Pitch, mm	Reel Size, inches	Devices per Reel	
8	4	7	Small quantity standards (see note)	20
				50
				100
				200
				500
				1000
			Standard	4000

Note: Please Consult individual model data sheet to determine device per reel availability.

Mini-Circuits carrier tape materials provide protection from ESD (Electro-Static Discharge) during handling and transportation. Tapes are static dissipative and comply with industry standards EIA-481/EIA-541.

Go to: [www.minicircuits.com/pages/pdfs/tape.pdf](http://www.minicircuits.com/pages/pdfs/tape.pdf)



INTERNET <http://www.minicircuits.com>

P.O. Box 350166, Brooklyn, New York 11235-0003 (718) 934-4500 Fax (718) 332-4661

Distribution Centers NORTH AMERICA 800-654-7949 • 417-335-5935 • Fax 417-335-5945 • EUROPE 44-1252-832600 • Fax 44-1252-837010

Mini-Circuits ISO 9001 & ISO 14001 Certified

THIRD ANGLE PROJECTION

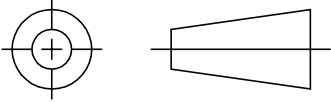

REVISIONS

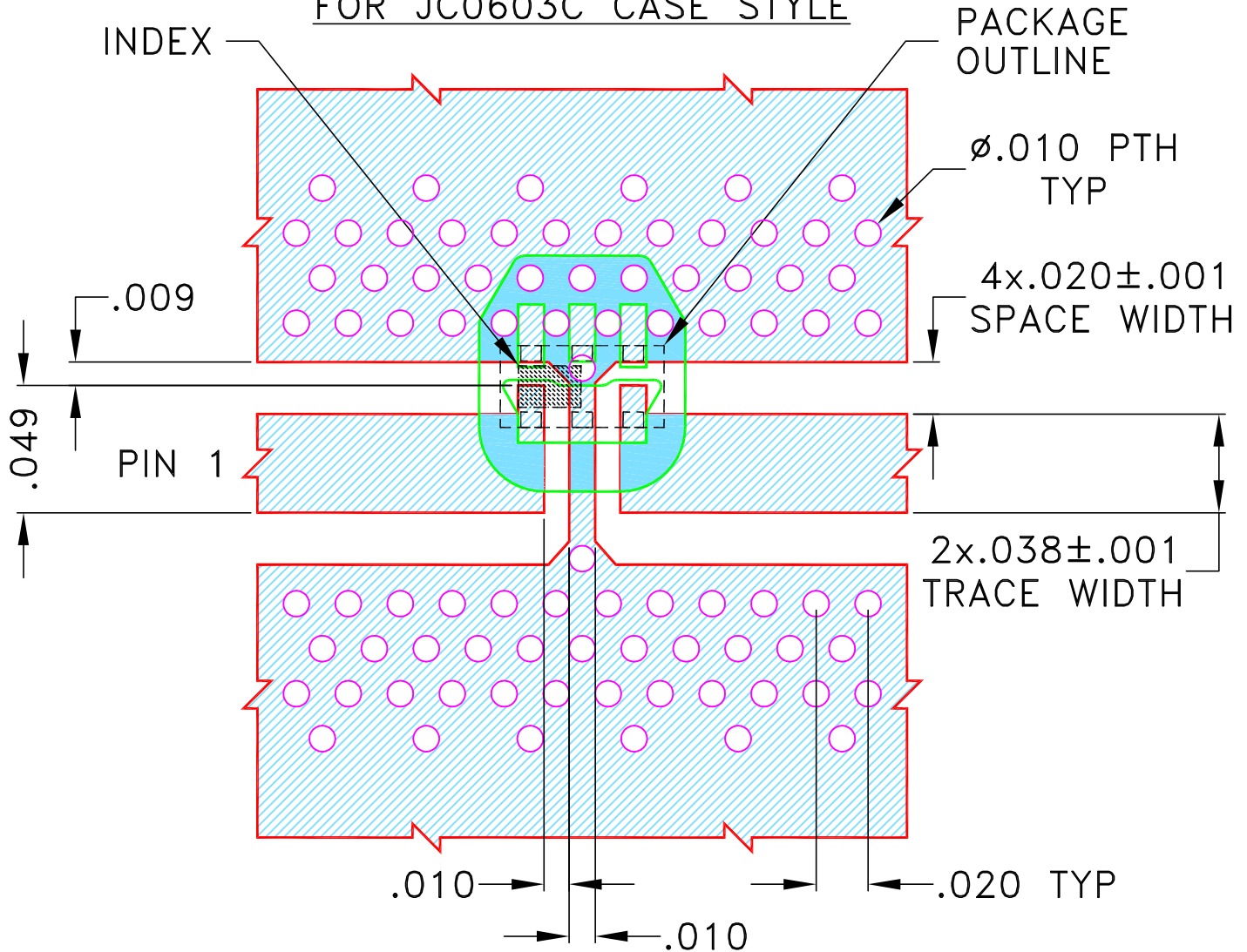

REV	ECN No.	DESCRIPTION	DATE	DR	AUTH
OR	ECO-006344	NEW RELEASE	FEB 21	KKR	VC

SUGGESTED MOUNTING CONFIGURATION  
FOR JC0603C CASE STYLE



NOTES:

1. COPLANAR WAVEGUIDE PARAMETERS ARE SHOWN FOR ROGERS (R03003) WITH DIELECTRIC THICKNESS  $.020 \pm .001$  COPPER: 1/2 Oz. EACH SIDE. FOR OTHER MATERIALS TRACE WIDTH AND GAP MAY NEED TO BE MODIFIED.
2. BOTTOM SIDE OF THE PCB IS CONTINUOUS GROUND PLANE.

 DENOTES PCB COPPER PATTERN WITH SMOBC (SOLDER MASK OVER BARE COPPER)  
 DENOTES PCB COPPER PATTERN FREE OF SOLDERMASK

UNLESS OTHERWISE SPECIFIED	INITIALS	DATE
DIMENSIONS ARE IN INCHES	DRAWN KKR	17 FEB 21
TOLERANCES ON:	CHECKED DDR	17 FEB 21
2 PL DECIMALS ±	APPROVED RV	17 FEB 21
3 PL DECIMALS ± .005		
ANGLES ±		
FRACTIONS ±		

 **Mini-Circuits®** 13 Neptune Avenue  
Brooklyn NY 11235

PL DWG, JC0603C C.S, 50 OHM, HFCW

Mini-Circuits®		SIZE	CODE IDENT	DRAWING NO:	REV:
THIS DOCUMENT AND ITS CONTENTS ARE THE PROPERTY OF MINI-CIRCUITS. EXCEPT FOR USE EXPRESSLY GRANTED, IN WRITING, TO ITS VENDORS, VENDEE AND THE UNITED STATES GOVERNMENT, MINI-CIRCUITS RESERVES ALL PROPRIETARY DESIGN, USE, MANUFACTURING AND REPRODUCTION RIGHTS THERETO. THESE CONTENTS SHALL NOT BE USED, DUPLICATED OR DISCLOSED TO ANY OUTSIDE PARTY, IN WHOLE OR IN PART, WITHOUT WRITTEN PERMISSION OF MINI-CIRCUITS.		A	15542	98-PL-704	OR
ASHEETA1.DWG REV:A DATE:01/12/95		FILE:	98PL704	SCALE:	15:1
				SHEET:	1 OF 1

# Evaluation Board and Circuit

TB-HFCW-1042+

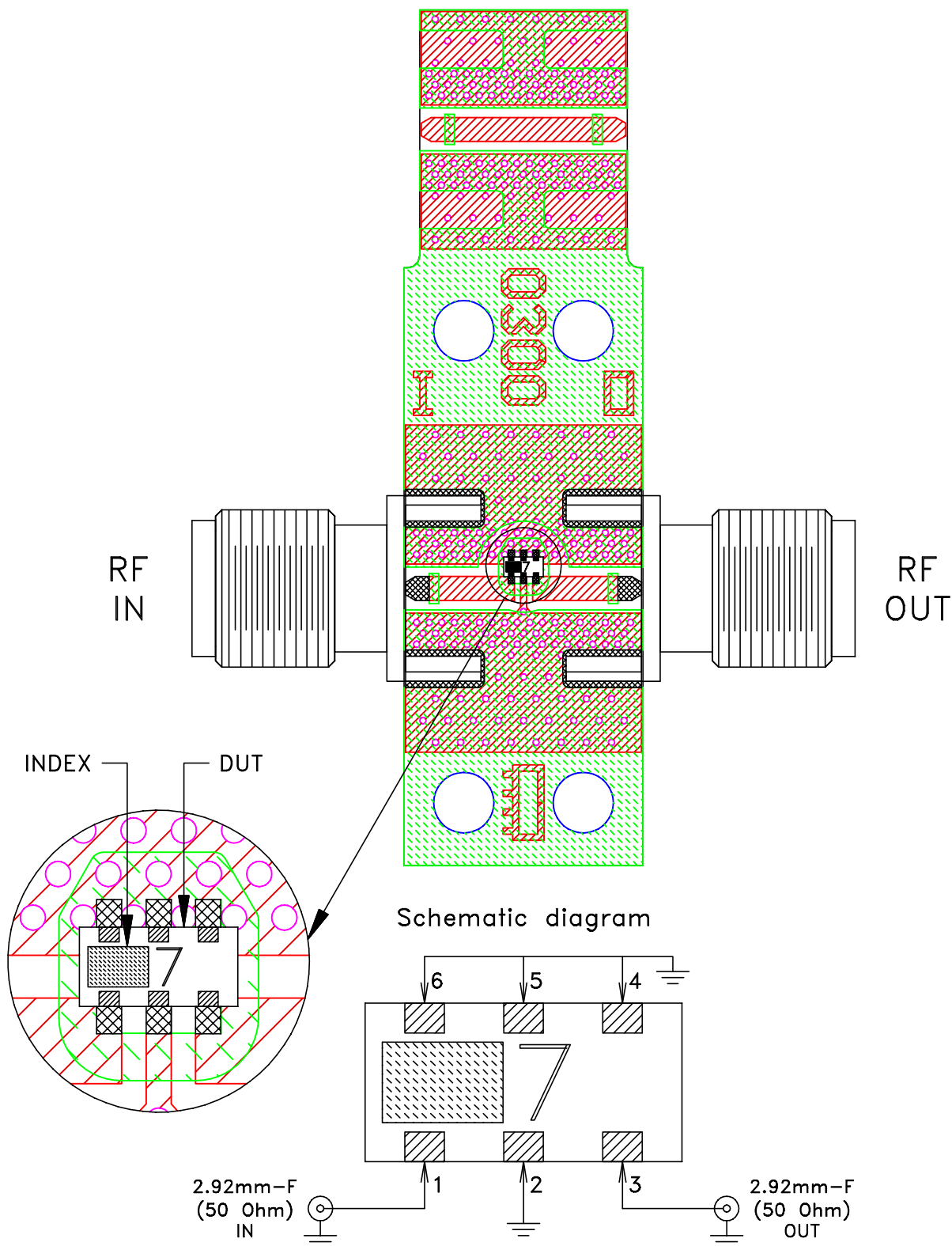

## Notes:

1. PCB Material: ROGERS (R03003) OR Equivalent, Dielectric Constant= $3.00 \pm 0.04$   
Dielectric Thickness:  $.020 \pm 0.001$
2. 50 Ohm 2.92mm Female Connectors.
3. Connectors on the test board shall not be subjected to temperature greater than  $200^{\circ}\text{C}$  to avoid permanent damage to the connectors.

 **Mini-Circuits®**

All Mini-Circuits products are manufactured under exacting quality assurance and control standards, and are capable of meeting published specifications after being subjected to any or all of the following physical and environmental test.

<b>Specification</b>	<b>Test/Inspection Condition</b>	<b>Reference/Spec</b>
Operating Temperature	-55° to 125° C Ambient Environment	Individual Model Data Sheet
Storage Temperature	-55° to 125° C Ambient Environment	Individual Model Data Sheet
Humidity	90 to 95% RH, 240 hours, 50°C	MIL-STD-202, Method 103, Condition A, Except 50°C and end-point electrical test done within 12 hours
Solder Reflow Heat	Sn-Pb Eutectic Process 225°C peak Pb-Free Process 245° - 250°C peak	J-STD-020C, Table 4-1, 4-2 and 5-2, Figure 5-1
Solderability	10X Magnification	J-STD-002, Para 4.2.5, Test S, 95% Coverage
Vibration (High Frequency)	20g peak, 10-2000 Hz, 12 times in each of three perpendicular directions (total 36)	MIL-STD-202, Method 204, Condition D
Mechanical Shock	50g, 11 ms, 1/2-sine, 18 shocks: 3 each direction, each of 3 axes	MIL-STD-202, Method 213, Condition A