



LTCC SURFACE MOUNT

# High Pass Filter

## HFCU-243+

50Ω 25 to 40 GHz

### THE BIG DEAL

- Low Insertion Loss, Typ. 2.6 dB
- Stopband Rejection, Typ. 51 dB
- Passband Return Loss, Typ. 16 dB
- 1812 Surface Mount Footprint
- Power Handling: 7 W

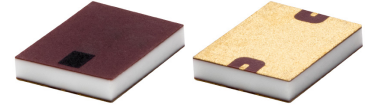

Generic photo used for illustration purposes only

### APPLICATIONS

- Test & Measurement Equipment
- Radar, EW, and ECM Defense System
- 5G MIMO and Back Haul Radio

### FUNCTIONAL DIAGRAM

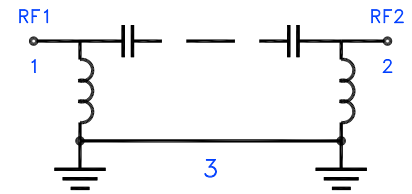

### PRODUCT OVERVIEW

Mini-Circuits' HFCU-243+ is a miniature low temperature co-fired ceramic (LTCC) high pass filter with a 25 to 40 GHz passband that supports a variety of applications. This model provides 2.6 dB typical insertion loss over a wide band due to its rugged monolithic construction. Housed in an 1812 ceramic form factor, this filter is ideal for dense signal chain PCB layouts, where it complements MMIC size and performance. The LTCC fabrication process assures minimal RF performance variation while delivering a product that is well suited for environmental extremes of high humidity and temperature.

### KEY FEATURES

Features	Advantages
Wide Passband, 15 GHz	This filter has a very wide passband, from 25 to 40 GHz.
LTCC Construction	The use of LTCC technology allows for repeatable performance in a rugged ceramic package, well suited for tough environments such as high humidity and temperature extremes. See Mini-Circuits Environmental Rating ENV06T10 for more information.
Small Size, 1812	1812 package allows for space to be saved in dense circuit board layouts, while also minimizing the effects of parasitics.
Rugged Power Handling, 7 W	Handles up to 7 Watts in a small 1812 package.





### ELECTRICAL SPECIFICATIONS<sup>1,2,3</sup> AT +25°C

Parameter		F#	Frequency (GHz)	Min.	Typ.	Max.	Units
Passband	Insertion Loss	F3-F4	25 - 27	—	2.6	—	dB
		F4-F5	27 - 38	—	2.6	3.2	
		F5-F6	38 - 40	—	2.9	—	
	Return Loss	F3-F4	25 - 27	—	16	—	dB
		F4-F5	27 - 38	—	13	—	
		F5-F6	38 - 40	—	15	—	
Stopband	Rejection	DC-F1	DC - 15	41	51	—	dB
		F1-F2	15 - 20	20	29	—	
	Freq. Cut-Off <sup>4</sup>	Fc	24	—	3	—	dB

1. Tested on Evaluation Board P/N TB-HFCU-243+.
2. Bi-directional RF1 and RF2 ports can be interchanged.
3. This component should not be used as a DC-block. In applications where DC voltage and/or current is present at either the input or output ports, external DC blocking capacitors are required.
4. Typical variation ±5%.

### ABSOLUTE MAXIMUM RATINGS<sup>5</sup>

Parameter	Ratings
Operating Temperature	-55°C to +125°C
Storage Temperature	-55°C to +125°C
Input Power <sup>6</sup>	7 W @ +25°C

5. Permanent damage may occur if any of these limits are exceeded.
6. Power rating applies only to signals within the passband. Power rating above +25°C operating temperature decreases linearly to 1.3 W at +125°C.

### TYPICAL FREQUENCY RESPONSE AT +25°C

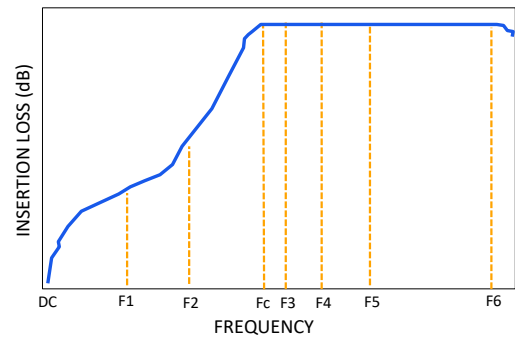



LTCC SURFACE MOUNT

# High Pass Filter

## HFCU-243+

Mini-Circuits

50Ω 25 to 40 GHz

### TYPICAL PERFORMANCE GRAPHS

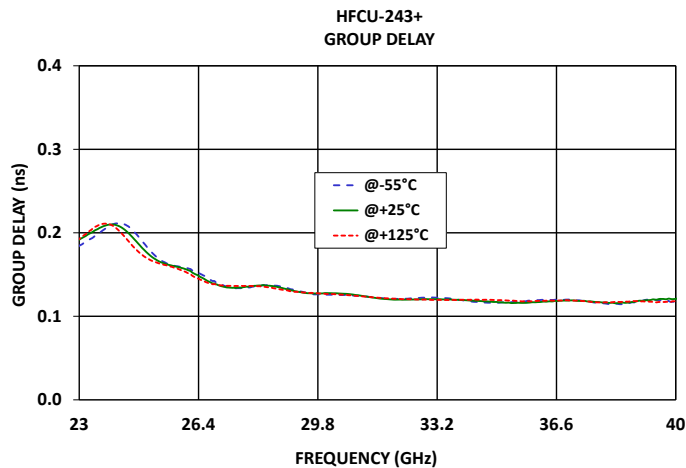
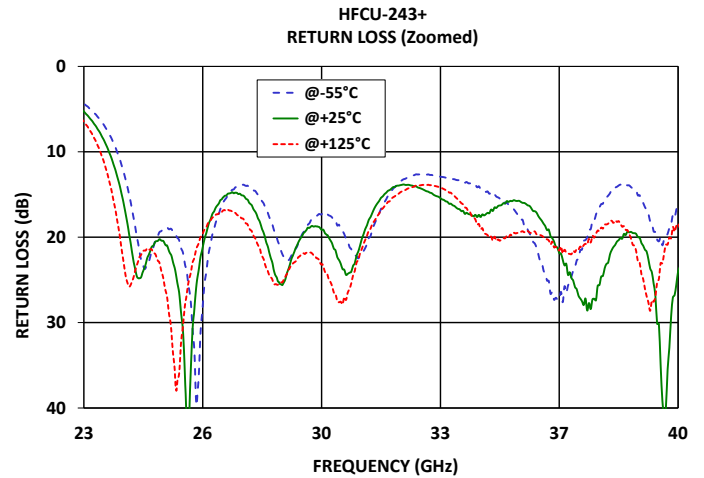
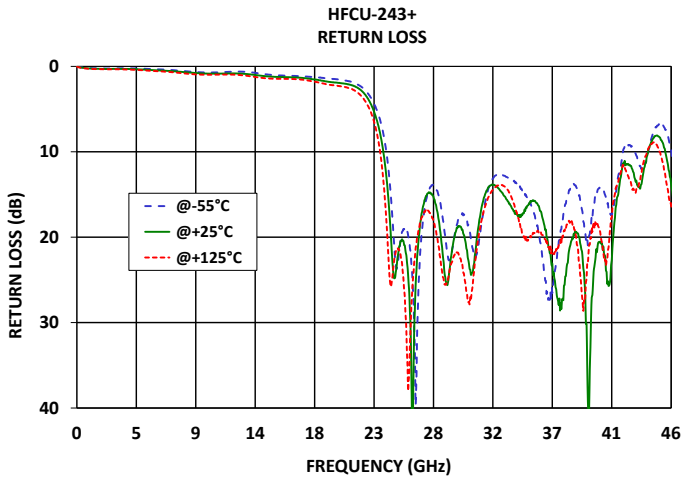
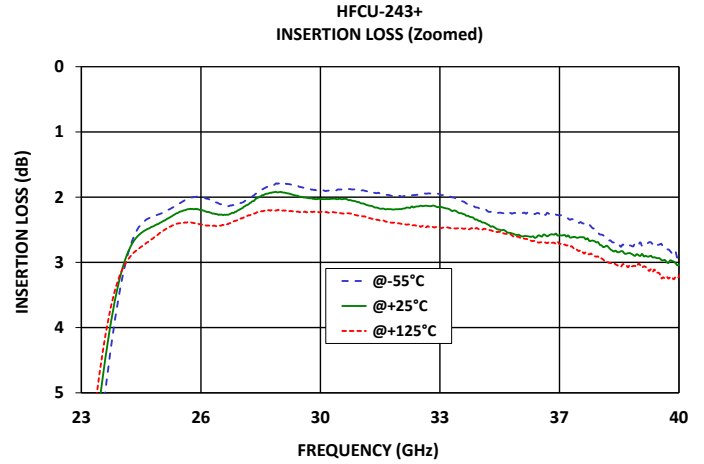
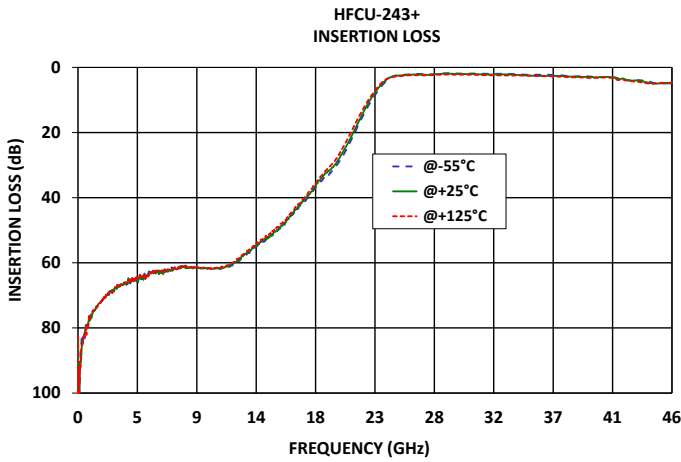



### FUNCTIONAL DIAGRAM

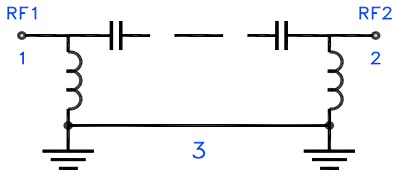
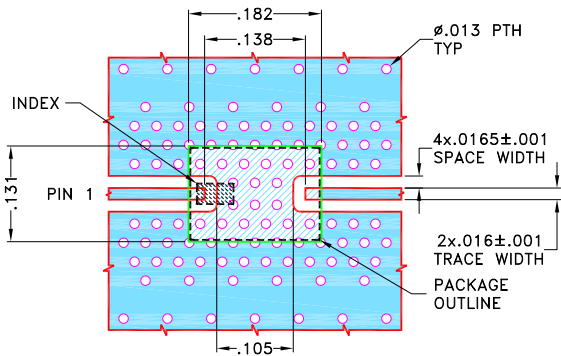

Figure 1. HFCU-243+ Functional Diagram

### PAD DESCRIPTION

Function	Pad Number	Description
RF1 <sup>2</sup>	1	Connects to RF Input Port
RF2 <sup>2</sup>	2	Connects to RF Output Port
GROUND	3	Connects to Ground on PCB, (See drawing PL-708)

### SUGGESTED PCB LAYOUT (PL-708)



NOTES:

1. COPLANAR WAVEGUIDE PARAMETERS ARE SHOWN FOR ROGERS (RO4835 Lo Pro) WITH DIELECTRIC THICKNESS .0073±.0007; COPPER: 1/2 oz. EACH SIDE. FOR OTHER MATERIALS TRACE WIDTH AND GAP MAY NEED TO BE MODIFIED.
  2. BOTTOM SIDE OF THE PCB IS CONTINUOUS GROUND PLANE.
- DENOTES PCB COPPER PATTERN WITH SMOBC (SOLDER MASK OVER BARE COPPER)  
 ■ DENOTES PCB COPPER PATTERN FREE OF SOLDERMASK

Figure 2. Suggested PCB Layout PL-708

### CASE STYLE DRAWING

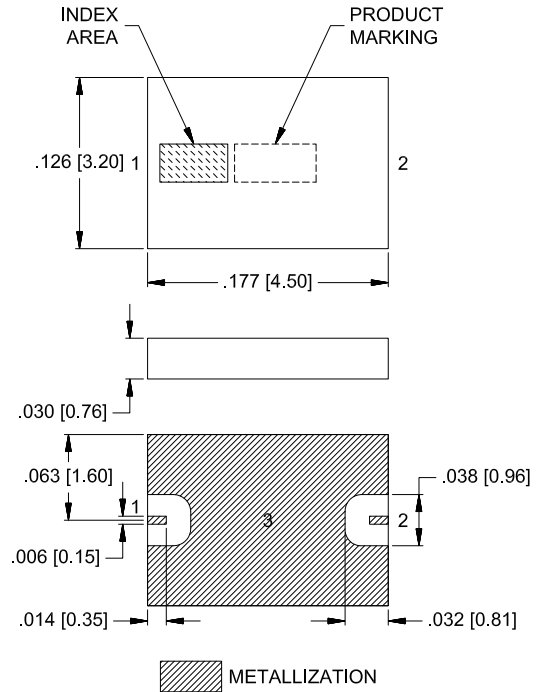

Weight: .04 grams

Dimensions are in inches [mm]. Tolerances: 2Pl. ± .01; 3Pl. ± .005

### PRODUCT MARKING\*: F558

\*Marking may contain other features or characters for internal lot control.



LTCC SURFACE MOUNT

# High Pass Filter

## HFCU-243+

50Ω 25 to 40 GHz

ADDITIONAL DETAILED INFORMATION IS AVAILABLE ON OUR DASH BOARD.

[CLICK HERE](#)

Performance Data and Graphs	Data
	Graphs S-Parameter (S2P Files) Data Set (.zip file) De-embedded to device pads
Case Style	NM1812C-5 Lead Finish: Gold over Nickel Plating.
RoHS Status	Compliant
Tape and Reel	F77
Suggested Layout for PCB Design	PL-708
Evaluation Board	TB-HFCU-243+
	Gerber File
Environmental Rating	ENV06T10

### NOTES

- A. Performance and quality attributes and conditions not expressly stated in this specification document are intended to be excluded and do not form a part of this specification document.
- B. Electrical specifications and performance data contained in this specification document are based on Mini-Circuits' applicable established test performance criteria and measurement instructions.
- C. The parts covered by this specification document are subject to Mini-Circuits' standard limited warranty and terms and conditions (collectively, "Standard Terms"); Purchasers of this part are entitled to the rights and benefits contained therein. For a full statement of the standard terms and the exclusive rights and remedies thereunder, please visit Mini-Circuits' website at [www.minicircuits.com/terms/viewterm.html](http://www.minicircuits.com/terms/viewterm.html)



*Typical Performance Data*

FREQ. (GHz)	INSERTION LOSS			INPUT RETURN LOSS			OUTPUT RETURN LOSS		
	(dB)			(dB)			(dB)		
	@-55°C	@+25°C	@+125°C	@-55°C	@+25°C	@+125°C	@-55°C	@+25°C	@+125°C
0.01	82.71	83.19	82.81	0.00	0.01	0.02	0.04	0.05	0.06
0.05	100.62	96.72	103.15	0.03	0.05	0.07	0.06	0.08	0.10
0.10	99.59	101.79	97.67	0.04	0.06	0.09	0.08	0.10	0.13
0.20	87.95	90.74	92.23	0.07	0.10	0.13	0.13	0.16	0.19
0.30	82.67	84.70	86.17	0.10	0.13	0.16	0.16	0.20	0.24
0.40	82.49	82.83	82.78	0.12	0.15	0.19	0.19	0.23	0.28
0.50	81.72	82.32	81.90	0.14	0.17	0.21	0.21	0.26	0.31
0.60	79.19	80.78	79.86	0.16	0.19	0.23	0.22	0.27	0.33
0.70	78.96	79.33	80.20	0.17	0.20	0.25	0.23	0.29	0.34
0.80	78.23	78.14	79.48	0.18	0.22	0.26	0.24	0.30	0.35
0.90	78.00	77.73	77.35	0.19	0.23	0.27	0.25	0.31	0.36
1.00	76.31	76.86	76.00	0.20	0.24	0.29	0.26	0.32	0.37
1.50	72.92	73.25	73.55	0.23	0.28	0.32	0.28	0.34	0.39
2.00	71.10	70.78	70.55	0.24	0.29	0.33	0.28	0.35	0.39
2.50	68.62	68.95	68.82	0.24	0.30	0.34	0.28	0.34	0.39
3.00	68.04	67.58	67.30	0.23	0.29	0.34	0.26	0.32	0.37
3.50	66.63	66.61	66.73	0.23	0.29	0.35	0.24	0.31	0.37
4.00	65.55	65.79	65.84	0.22	0.30	0.37	0.25	0.33	0.40
4.50	65.44	65.15	65.43	0.24	0.33	0.41	0.27	0.37	0.45
5.00	64.90	64.53	64.45	0.26	0.36	0.44	0.31	0.42	0.51
5.50	62.60	63.79	64.31	0.29	0.40	0.49	0.35	0.47	0.57
6.00	63.00	62.84	62.93	0.33	0.45	0.54	0.39	0.52	0.63
6.50	62.30	62.82	62.36	0.36	0.48	0.58	0.42	0.55	0.66
7.00	62.67	62.50	62.16	0.40	0.53	0.64	0.44	0.58	0.70
7.50	61.74	61.61	61.29	0.44	0.57	0.70	0.46	0.60	0.73
8.00	61.25	61.04	61.54	0.51	0.63	0.77	0.48	0.63	0.77
8.50	61.51	61.29	61.40	0.58	0.70	0.85	0.52	0.67	0.83
9.00	61.29	61.34	61.16	0.63	0.75	0.91	0.58	0.73	0.90
9.50	61.70	61.69	61.58	0.69	0.81	0.96	0.67	0.81	0.98
10.00	61.64	61.82	61.78	0.71	0.83	0.97	0.74	0.88	1.04
10.50	61.77	61.85	61.51	0.71	0.85	0.97	0.79	0.92	1.07
11.00	61.86	61.81	61.43	0.69	0.85	0.96	0.80	0.94	1.08
11.50	61.27	61.04	60.80	0.66	0.83	0.95	0.75	0.90	1.05
12.00	60.43	60.23	59.89	0.62	0.83	0.96	0.68	0.87	1.03
12.50	59.26	58.82	58.44	0.61	0.83	0.99	0.62	0.84	1.02
13.00	57.73	57.19	56.82	0.64	0.88	1.08	0.61	0.85	1.05
13.50	55.98	55.64	55.17	0.70	0.95	1.17	0.65	0.90	1.12
14.80	52.01	52.24	51.20	0.96	1.18	1.42	0.92	1.17	1.40
15.00	51.27	51.13	50.82	0.99	1.19	1.43	0.96	1.21	1.44
17.00	43.51	43.11	42.37	1.13	1.30	1.49	1.16	1.37	1.60
19.00	34.23	33.28	32.60	1.34	1.68	1.98	1.31	1.59	1.96
20.00	30.32	29.39	27.99	1.49	1.89	2.24	1.54	1.91	2.30
21.00	23.55	22.57	21.01	1.71	2.09	2.52	1.89	2.27	2.70
22.00	15.41	14.54	13.30	2.36	2.80	3.44	2.35	2.90	3.51
23.00	8.49	7.70	7.10	4.34	5.28	6.45	3.80	4.84	5.95
24.00	3.73	3.47	3.35	10.54	13.56	19.13	10.40	13.41	18.52
25.00	2.30	2.46	2.64	21.01	20.90	21.86	20.16	19.65	19.33
26.00	2.03	2.19	2.39	25.87	44.36	25.15	25.54	25.32	20.24
27.00	2.11	2.27	2.43	15.83	15.28	16.84	14.39	14.59	16.03
28.00	1.94	2.01	2.23	15.10	17.94	21.07	17.01	19.57	24.81
29.00	1.81	1.96	2.22	21.88	21.92	22.99	26.59	24.14	26.52
30.00	1.90	2.03	2.23	17.43	20.00	24.85	20.24	22.19	29.04
32.00	1.99	2.19	2.40	13.68	13.96	14.93	15.66	15.23	16.58
34.00	2.11	2.29	2.49	13.69	17.29	16.99	15.63	17.66	17.98
35.00	2.25	2.50	2.55	15.65	16.02	20.11	14.95	15.53	18.36
36.00	2.24	2.58	2.70	21.97	17.52	19.72	17.25	16.72	18.36
37.00	2.35	2.61	2.78	23.89	25.09	21.59	19.67	23.27	21.48
38.00	2.66	2.77	3.00	15.13	22.97	18.41	17.44	20.90	19.02
39.00	2.73	2.91	3.06	15.98	20.98	24.89	16.93	19.84	24.51
40.00	2.91	3.04	3.22	16.14	24.01	18.41	23.52	29.62	22.59

## Typical Performance Data

FREQ.  (GHz)	GROUP DELAY		
	(nsec)		
	@-55°C	@+25°C	@+125°C
25.00	0.18	0.17	0.17
25.50	0.16	0.16	0.16
26.00	0.16	0.16	0.15
26.50	0.15	0.15	0.14
27.00	0.14	0.14	0.14
27.50	0.13	0.13	0.14
28.00	0.14	0.14	0.14
28.50	0.14	0.14	0.13
29.00	0.13	0.13	0.13
29.50	0.13	0.13	0.13
30.00	0.13	0.13	0.13
30.10	0.13	0.13	0.13
30.20	0.13	0.13	0.13
30.30	0.13	0.13	0.13
30.50	0.13	0.13	0.13
30.70	0.13	0.13	0.13
31.00	0.12	0.12	0.12
31.50	0.12	0.12	0.12
31.70	0.12	0.12	0.12
32.00	0.12	0.12	0.12
32.10	0.12	0.12	0.12
32.20	0.12	0.12	0.12
32.50	0.12	0.12	0.12
32.60	0.12	0.12	0.12
32.80	0.12	0.12	0.12
33.00	0.12	0.12	0.12
33.20	0.12	0.12	0.12
33.40	0.12	0.12	0.12
33.60	0.12	0.12	0.12
34.00	0.12	0.12	0.12
34.50	0.12	0.12	0.12
35.00	0.12	0.12	0.12
35.50	0.12	0.12	0.12
36.00	0.12	0.12	0.12
36.50	0.12	0.12	0.12
37.00	0.12	0.12	0.12
38.00	0.12	0.12	0.12
39.00	0.12	0.12	0.12
39.50	0.12	0.12	0.12
40.00	0.12	0.12	0.12

## Typical Performance Curves

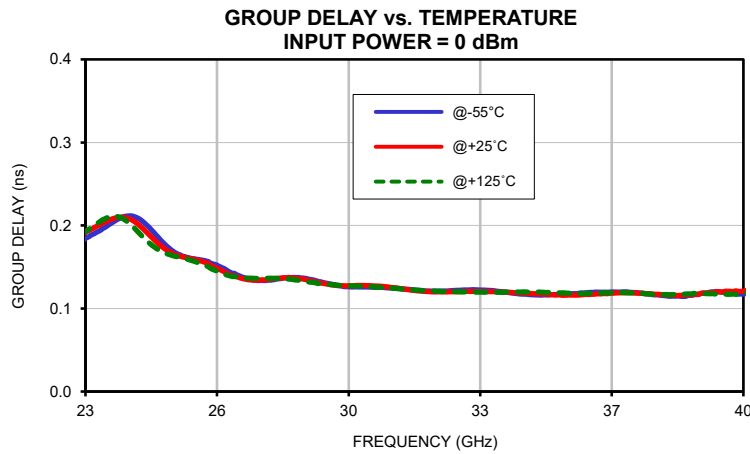
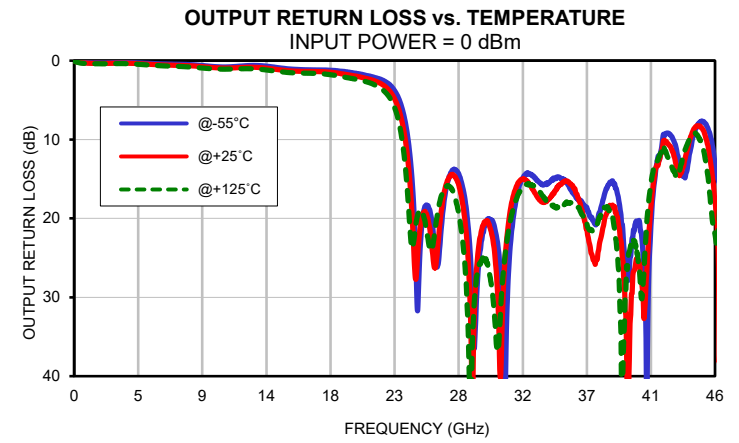
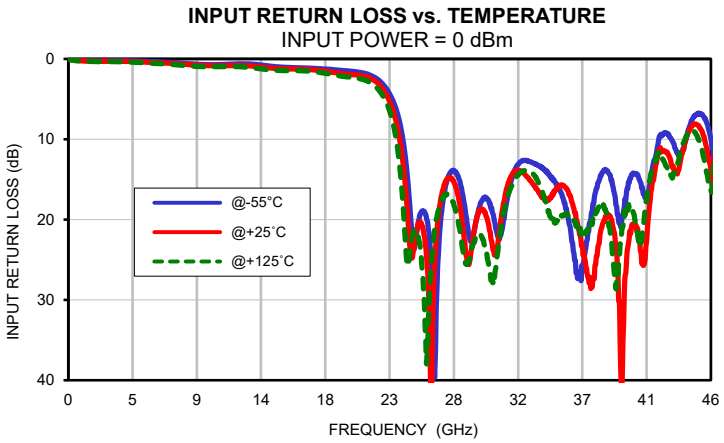
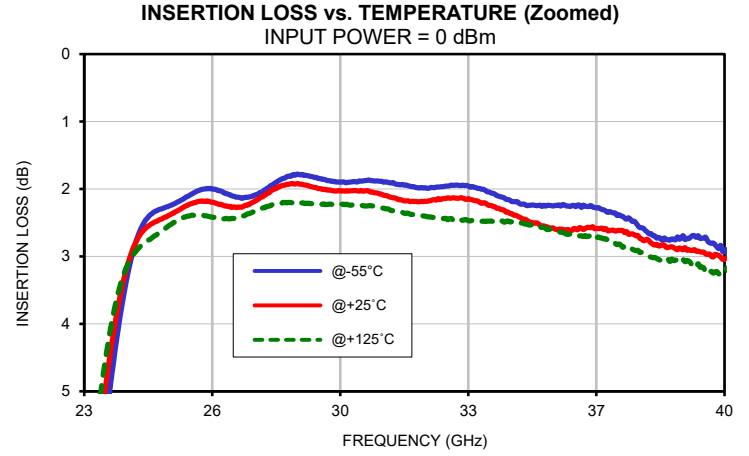
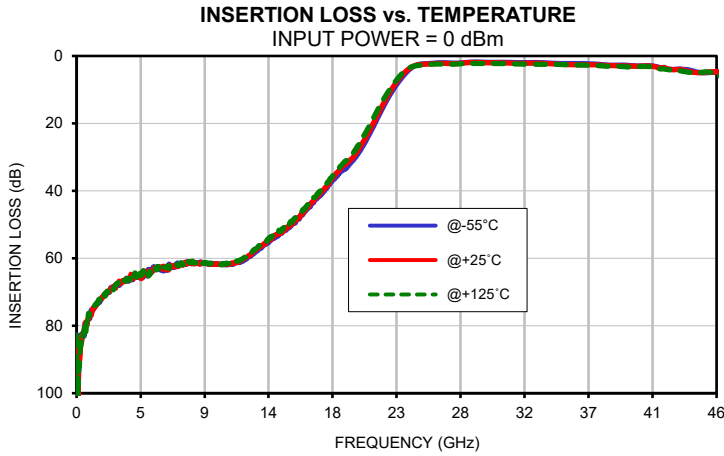



## Outline Dimensions

## NM1812C-5

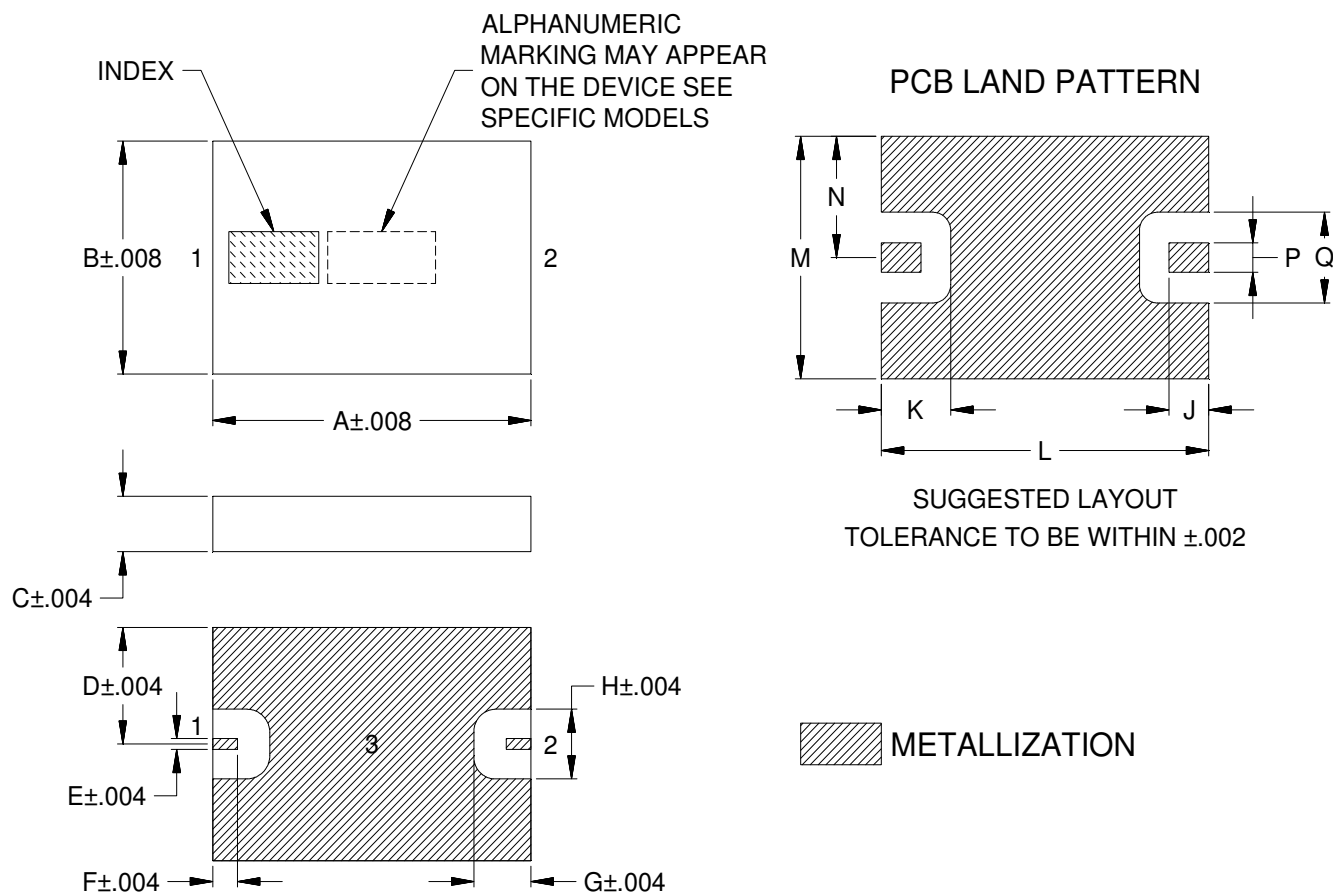

CASE#	A	B	C	D	E	F	G	H	J	K	L	M	N	P	Q	WT.GRAM
NM1812C-5	.177 (4.50)	.126 (3.20)	.030 (0.76)	.063 (1.60)	.006 (0.15)	.014 (0.35)	.032 (0.81)	.038 (0.96)	.022 (0.56)	.039 (0.98)	.182 (4.63)	.131 (3.33)	.065 (1.66)	.016 (0.41)	.049 (1.24)	0.04

Dimensions are in inches (mm). Tolerances: 2Pl.  $\pm .01$ ; 3Pl.  $\pm .005$

### Notes:

1. Open style, Ceramic base.
2. Termination finish: **as shown below or indicated on Data Sheet.**  
For RoHS Case Styles: Gold plate over Nickel plate. All models, (+) suffix.
3. Pad tolerance is non-cumulative. Minimum spacing between each pad is .004.



P.O. Box 350166, Brooklyn, New York 11235-0003 (718) 934-4500 Fax (718) 332-4661 For detailed performance specs & shopping online see Mini-Circuits web site



The Design Engineers Search Engine Provides ACTUAL Data Instantly From MINI-CIRCUITS At: [www.minicircuits.com](http://www.minicircuits.com)

RF/IF MICROWAVE COMPONENTS

THIRD ANGLE PROJECTION

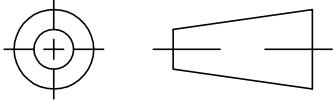

REVISIONS

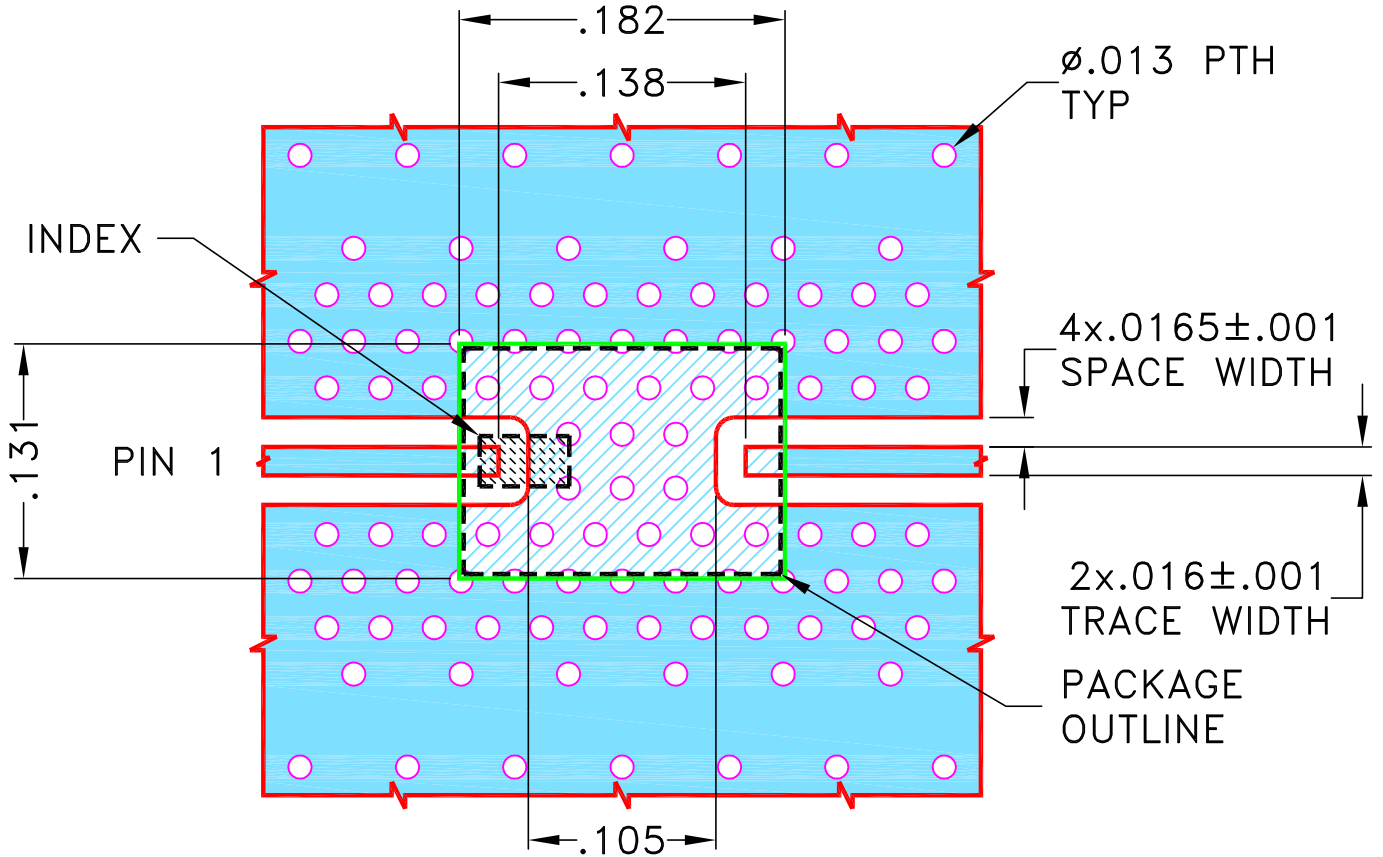

REV	ECN No.	DESCRIPTION	DATE	DR	AUTH
OR	ECO-015456	NEW RELEASE	OCT 22	DDR	VC

SUGGESTED MOUNTING CONFIGURATION FOR NM1812C-5 CASE STYLE



NOTES:

1. COPLANAR WAVEGUIDE PARAMETERS ARE SHOWN FOR ROGERS (R04835 Lo Pro) WITH DIELECTRIC THICKNESS  $.0073 \pm .0007$ ; COPPER: 1/2 Oz. EACH SIDE. FOR OTHER MATERIALS TRACE WIDTH AND GAP MAY NEED TO BE MODIFIED.
2. BOTTOM SIDE OF THE PCB IS CONTINUOUS GROUND PLANE.

 DENOTES PCB COPPER PATTERN WITH SMOBC (SOLDER MASK OVER BARE COPPER)  
 DENOTES PCB COPPER PATTERN FREE OF SOLDERMASK

UNLESS OTHERWISE SPECIFIED	INITIALS	DATE
DIMENSIONS ARE IN INCHES	DRAWN: DDR	20 OCT 22
TOLERANCES ON:	CHECKED: GTP	20 OCT 22
2 PL DECIMALS ±	APPROVED: RKS	20 OCT 22
3 PL DECIMALS ± .005		
ANGLES ±		
FRACTIONS ±		

 **Mini-Circuits®** 13 Neptune Avenue  
Brooklyn NY 11235

PL DWG NM1812C-5 C.S 50 OHM HFHK

SIZE: A	CODE IDENT: 15542	DRAWING NO: 98-PL-708	REV: OR
FILE: 98-PL-708	SCALE: 9:1	SHEET: 1 OF 1	

THIS DOCUMENT AND ITS CONTENTS ARE THE PROPERTY OF MINI-CIRCUITS. EXCEPT FOR USE EXPRESSLY GRANTED, IN WRITING, TO ITS VENDORS, VENDEE AND THE UNITED STATES GOVERNMENT, MINI-CIRCUITS RESERVES ALL PROPRIETARY DESIGN, USE, MANUFACTURING AND REPRODUCTION RIGHTS THERETO. THESE CONTENTS SHALL NOT BE USED, DUPLICATED OR DISCLOSED TO ANY OUTSIDE PARTY, IN WHOLE OR IN PART, WITHOUT WRITTEN PERMISSION OF MINI-CIRCUITS.

# Evaluation Board and Circuit

TB-HFCU-243+

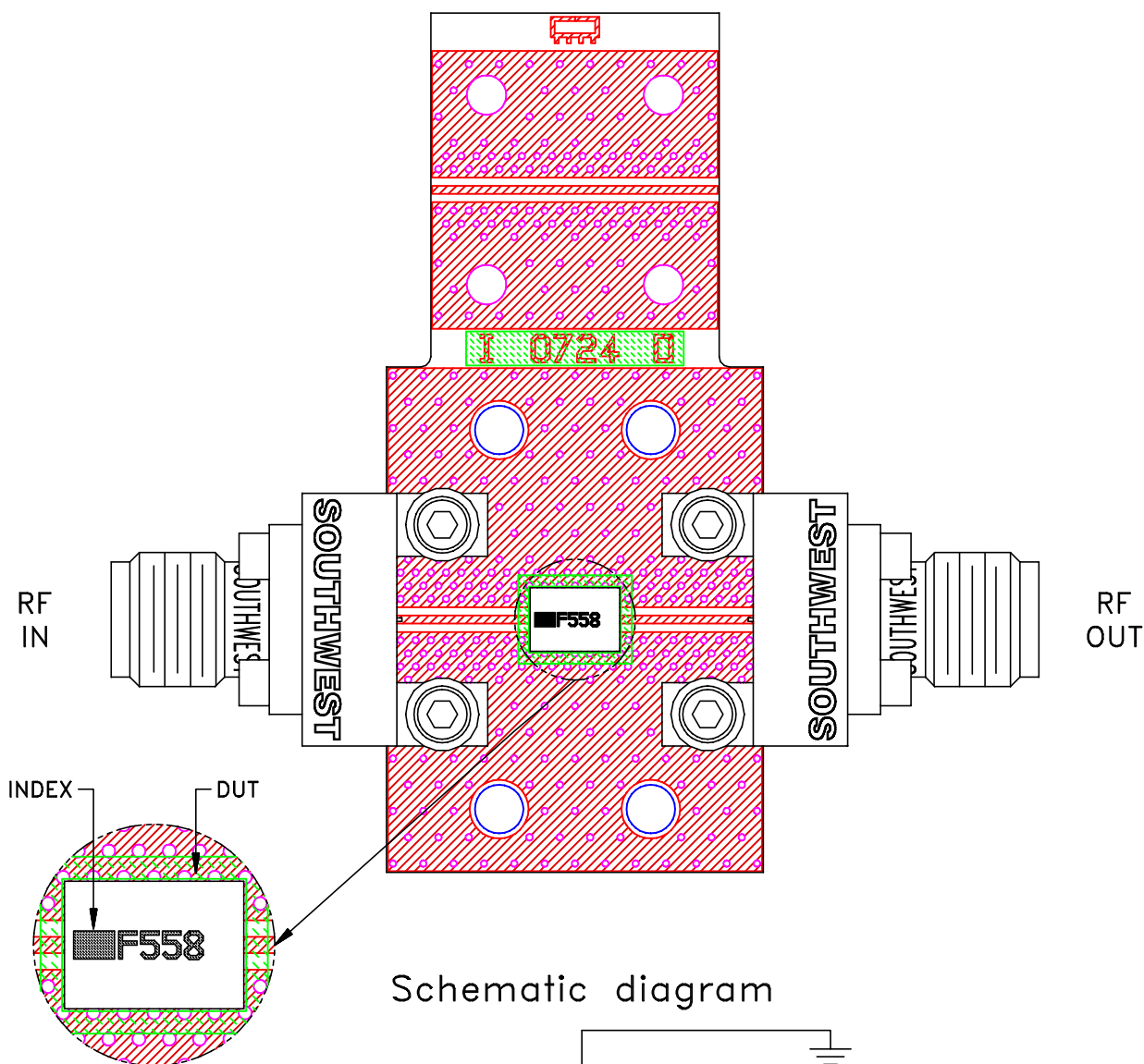

Schematic diagram

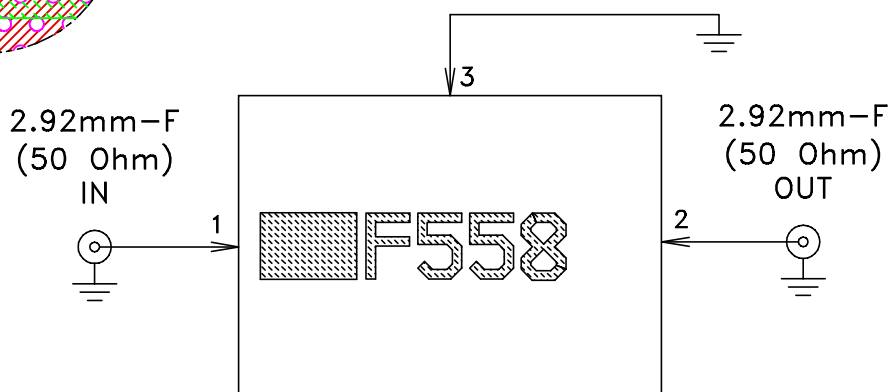

## Notes:

1. PCB Material: ROGERS (R04835 Lo Pro) OR Equivalent, Dielectric Constant= $3.48 \pm 0.05$   
Dielectric Thickness:  $.0073 \pm 0.0007$
2. 50 Ohm 2.92mm Female Connectors.

 **Mini-Circuits®**

All Mini-Circuits products are manufactured under exacting quality assurance and control standards, and are capable of meeting published specifications after being subjected to any or all of the following physical and environmental test.

Specification	Test/Inspection Condition	Reference/Spec
Operating Temperature	-55° to 125° C Ambient Environment	Individual Model Data Sheet
Storage Temperature	-55° to 125° C Ambient Environment	Individual Model Data Sheet
Humidity	90 to 95% RH, 240 hours, 50°C	MIL-STD-202, Method 103, Condition A, Except 50°C and end-point electrical test done within 12 hours
Solder Reflow Heat	Sn-Pb Eutectic Process 225°C peak Pb-Free Process 245° - 250°C peak	J-STD-020C, Table 4-1, 4-2 and 5-2, Figure 5-1
Solderability	10X Magnification	J-STD-002, Test B,B1, 95% Coverage
Thermal Shock	-55° to +125°C, 15 min dwell,250 cycles	MIL-STD-202, Method 107
Bend Test	1mm, deflection for 5 seconds Span of bending: 2.75"	--
High Temp Storage	125°C to 1000 Hrs	---