



LTCC SURFACE MOUNT

# High Pass Filter

## HFCG-650+

50Ω 730 to 6500 MHz

### THE BIG DEAL

- Insertion Loss, 0.7 dB Typ.
- Stop Band Rejection, 47 dB Typ.
- Pass Band Return Loss, 11 dB Typ.
- 0805 Surface Mount Footprint
- Power Handling: 2 W



Generic photo used for illustration purposes only

### APPLICATIONS

- Test & Measurement Equipment
- Radar, EW, and ECM Defense System
- 5G MIMO and Back Haul Radio
- 5G Sub 6 GHz and WiFi 6E

### FUNCTIONAL DIAGRAM

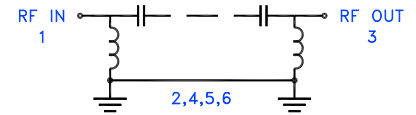

### PRODUCT OVERVIEW

Mini-Circuits' HFCG-650+ is a miniature low temperature co-fired ceramic (LTCC) high pass filter with a 730 to 6500 MHz passband that supports a variety of applications. This model provides 0.7 dB typical insertion loss over a wide band due to its rugged monolithic construction. Housed in a tiny 0805 ceramic form factor which is ideal for dense signal chain PCB layouts where it complements MMIC size and performance. The LTCC fabrication process assures minimal RF performance variation while delivering a product that is well suited for environmental extremes of high humidity and temperature.

### KEY FEATURES

Features	Advantages
Wide passband, 5.77 GHz	This filter has a very wide passband from, 730 to 6500 MHz.
LTCC Construction	The use of LTCC technology allows for repeatable performance in a rugged ceramic package, well suited for tough environments such as high humidity and temperature extremes. See Mini-Circuits Environmental Rating ENV06T11 for more information.
Small Size, 0805	0805 package allows for space to be saved in dense circuit board layouts, while also minimizing the effects of parasitics
Rugged Power Handling, 2 W	Handles up to 2 Watts in a small 0805 package.

REV. OR  
ECO-019931  
HFCG-650+  
EDU4565  
URJ  
231213





### ELECTRICAL SPECIFICATIONS<sup>1,2,3</sup> AT +25°C

Parameter		F#	Frequency (MHz)	Min.	Typ.	Max.	Units
Passband	Insertion Loss	F3-F4	730 - 1800	—	3.1	—	dB
		F4-F5	1800 - 5000	—	0.7	1.3	
		F5-F6	5000 - 6500	—	0.8	1.5	
	Return Loss	F3-F4	730 - 1800	—	7	—	dB
		F4-F5	1800 - 5000	—	11	—	
		F5-F6	5000 - 6500	—	11	—	
Stopband	Rejection	DC-F1	DC - 390	39	47	—	dB
		F1-F2	390 - 490	20	35	—	
	Freq. Cut-Off <sup>4</sup>	Fc	650	—	3	—	

1. Tested on Evaluation Board P/N TB-HFCG-650+.
2. Bi-directional RF1 and RF2 ports can be interchanged.
3. This component should not be used as a DC-block. In applications where DC voltage and/or current is present at either the input or output ports, external DC blocking capacitors are required.
4. Typical variation ±5%.

### ABSOLUTE MAXIMUM RATINGS<sup>5</sup>

Parameter	Ratings
Operating Temperature	-55°C to +125°C
Storage Temperature	-55°C to +125°C
Input Power <sup>6</sup>	2 W @ +25°C

5. Permanent damage may occur if any of these limits are exceeded.
6. Power rating applies only to signals within the passband. Power rating above +25°C operating temperature decreases linearly to 0.5 W at +125°C.

### TYPICAL FREQUENCY RESPONSE AT +25°C

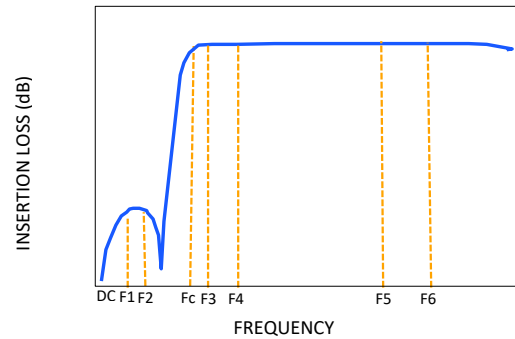



LTCC SURFACE MOUNT

# High Pass Filter

## HFCG-650+

Mini-Circuits

50Ω 730 to 6500 MHz

### TYPICAL PERFORMANCE GRAPHS

HFCG-650+  
INSERTION LOSS

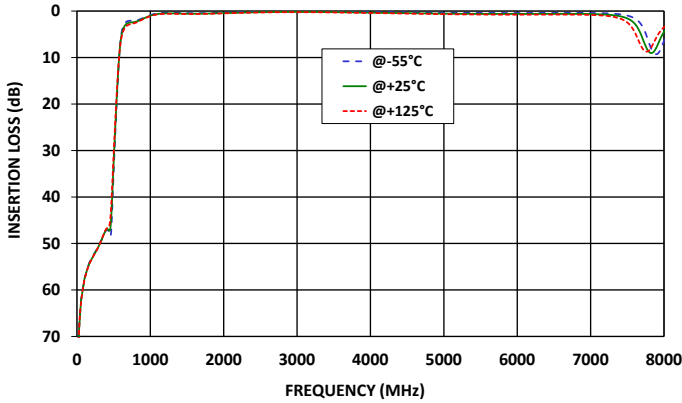

HFCG-650+  
INSERTION LOSS (Zoomed)

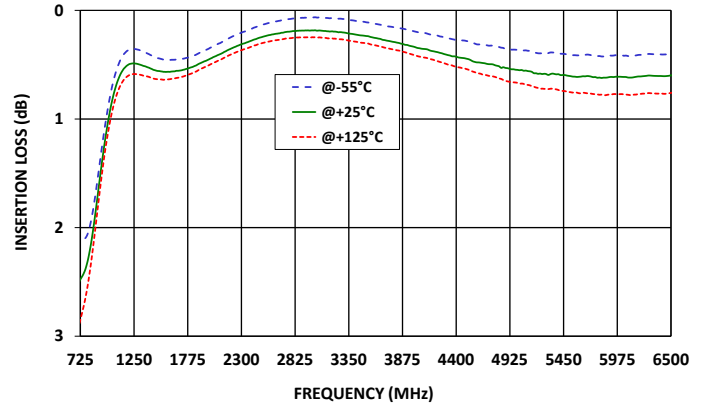

HFCG-650+  
RETURN LOSS

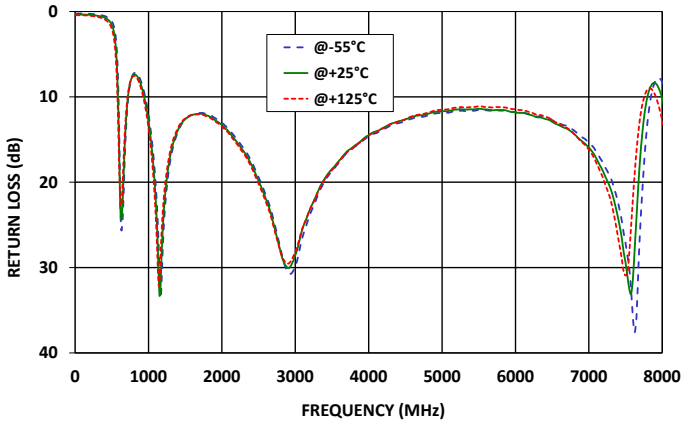

HFCG-650+  
RETURN LOSS (Zoomed)

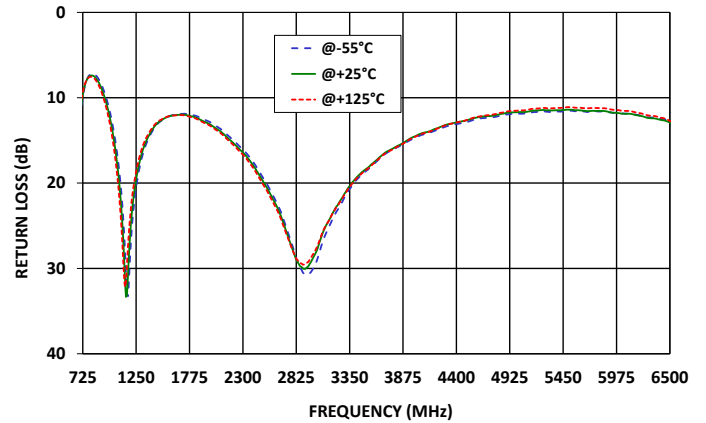

HFCG-650+  
GROUP DELAY

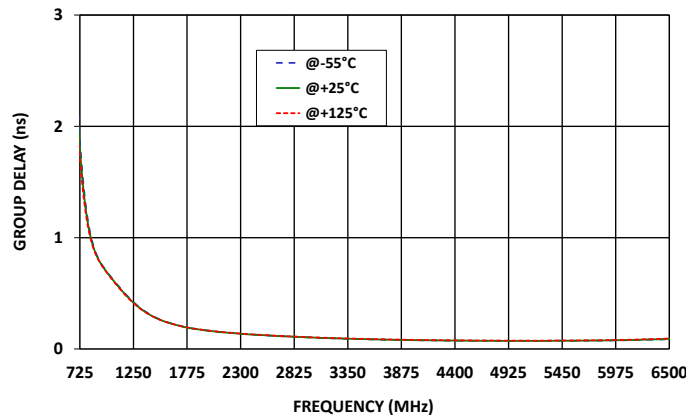

Mini-Circuits



### FUNCTIONAL DIAGRAM

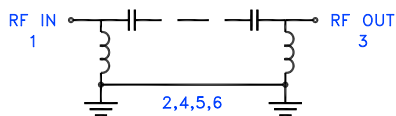
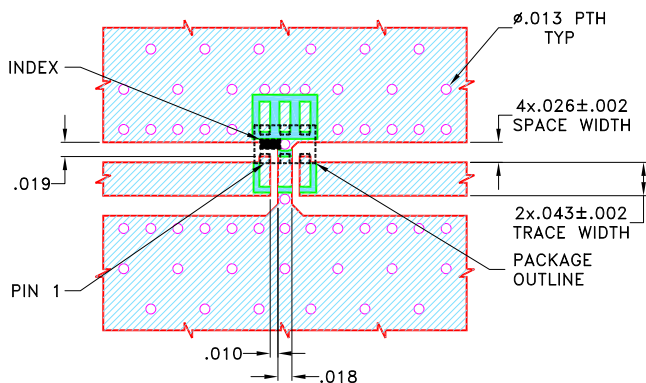

Figure 1. HFCG-650+ Functional Diagram

### PAD DESCRIPTION

Function	Pad Number	Description
RF1 <sup>2</sup>	1	Connects to RF Input Port
RF2 <sup>2</sup>	3	Connects to RF Output Port
GROUND	2,4,5,6	Connects to Ground on PCB, (See drawing PL-633)

### SUGGESTED PCB LAYOUT (PL-633)



NOTES:

1. COPLANAR WAVEGUIDE PARAMETERS ARE SHOWN FOR ROGERS (R04350B) WITH DIELECTRIC THICKNESS .020±.0015. COPPER: 1/2 Oz. EACH SIDE. FOR OTHER MATERIALS TRACE WIDTH AND GAP MAY NEED TO BE MODIFIED.
  2. BOTTOM SIDE OF THE PCB IS CONTINUOUS GROUND PLANE.
- DENOTES PCB COPPER PATTERN WITH SMOBC (SOLDER MASK OVER BARE COPPER)  
 ▨ DENOTES PCB COPPER PATTERN FREE OF SOLDERMASK

Figure 2. Suggested PCB Layout PL-633

### CASE STYLE DRAWING

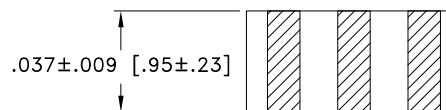
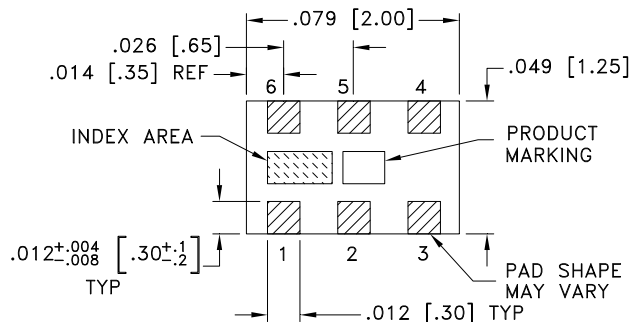

Weight: .008 grams.

Dimensions are in inches (mm). Tolerances: 2Pl. ± .01; 3 Pl. ± .005

### PRODUCT MARKING\*: XY

\*Marking may contain other features or characters for internal lot control.



LTCC SURFACE MOUNT

# High Pass Filter

## HFCG-650+

50Ω 730 to 6500MHz

Mini-Circuits

ADDITIONAL DETAILED INFORMATION IS AVAILABLE ON OUR DASH BOARD.

[CLICK HERE](#)

Performance Data and Graphs	Data
	Graphs
	S-Parameter (S2P Files) Data Set (.zip file) De-embedded to device pads
Case Style	GE0805C-9 Lead Finish: Tin over Nickel Plating.
RoHS Status	Compliant
Tape and Reel	F114
Suggested Layout for PCB Design	PL-633
Evaluation Board	TB-HFCG-650+
	Gerber File
Environmental Rating	ENV06T11

### NOTES

- A. Performance and quality attributes and conditions not expressly stated in this specification document are intended to be excluded and do not form a part of this specification document.
- B. Electrical specifications and performance data contained in this specification document are based on Mini-Circuits' applicable established test performance criteria and measurement instructions.
- C. The parts covered by this specification document are subject to Mini-Circuits' standard limited warranty and terms and conditions (collectively, "Standard Terms"); Purchasers of this part are entitled to the rights and benefits contained therein. For a full statement of the standard terms and the exclusive rights and remedies thereunder, please visit Mini-Circuits' website at [www.minicircuits.com/terms/viewterm.html](http://www.minicircuits.com/terms/viewterm.html)



*Typical Performance Data*

FREQ. (MHz)	INSERTION LOSS			INPUT RETURN LOSS			OUTPUT RETURN LOSS		
	(dB)			(dB)			(dB)		
	@-55°C	@+25°C	@+125°C	@-55°C	@+25°C	@+125°C	@-55°C	@+25°C	@+125°C
10	73.54	89.79	74.14	0.24	0.36	0.43	0.24	0.36	0.43
20	71.00	73.22	72.35	0.24	0.36	0.43	0.24	0.36	0.43
30	67.93	68.39	68.60	0.23	0.35	0.43	0.23	0.35	0.43
40	65.62	66.05	65.23	0.23	0.35	0.43	0.23	0.35	0.43
50	63.52	63.59	63.66	0.23	0.35	0.43	0.23	0.35	0.43
60	61.93	61.73	62.27	0.23	0.35	0.43	0.23	0.35	0.43
70	60.58	60.97	60.80	0.23	0.35	0.43	0.23	0.35	0.43
80	59.79	59.68	59.79	0.23	0.35	0.43	0.23	0.35	0.43
90	58.75	58.99	58.80	0.23	0.35	0.44	0.23	0.35	0.44
100	57.91	57.82	57.98	0.23	0.35	0.44	0.23	0.35	0.44
150	54.96	55.11	55.26	0.24	0.37	0.46	0.24	0.37	0.46
200	53.24	53.35	53.47	0.27	0.39	0.49	0.27	0.39	0.49
250	51.80	51.94	51.94	0.31	0.43	0.54	0.31	0.43	0.54
300	50.40	50.47	50.52	0.36	0.49	0.62	0.36	0.49	0.62
350	48.70	48.66	48.56	0.42	0.57	0.73	0.42	0.57	0.73
390	47.32	47.27	47.11	0.50	0.68	0.87	0.50	0.68	0.87
430	47.34	47.04	46.44	0.63	0.85	1.09	0.63	0.85	1.09
490	38.56	36.37	34.25	1.03	1.40	1.80	1.03	1.40	1.80
580	8.93	8.85	8.85	6.77	8.80	10.89	6.77	8.80	10.89
600	5.49	5.89	6.29	13.70	16.21	17.93	13.70	16.21	17.93
650	2.71	3.21	3.70	23.93	21.77	19.48	23.93	21.77	19.48
700	2.12	2.55	2.97	12.74	11.99	11.30	12.74	11.99	11.30
730	2.09	2.47	2.83	9.59	9.34	9.08	9.59	9.34	9.08
800	2.05	2.29	2.51	7.26	7.42	7.55	7.26	7.42	7.55
880	1.64	1.81	1.94	7.80	8.17	8.51	7.80	8.17	8.51
900	1.51	1.66	1.78	8.24	8.66	9.05	8.24	8.66	9.05
950	1.17	1.30	1.41	9.80	10.35	10.91	9.80	10.35	10.91
1000	0.87	1.00	1.10	12.10	12.84	13.60	12.10	12.84	13.60
1150	0.40	0.54	0.64	30.58	33.30	31.48	30.58	33.30	31.48
1200	0.36	0.50	0.60	26.63	24.57	22.74	26.63	24.57	22.74
1300	0.36	0.50	0.59	17.31	16.74	16.19	17.31	16.74	16.19
1400	0.41	0.53	0.61	14.11	13.91	13.67	14.11	13.91	13.67
1500	0.44	0.56	0.63	12.67	12.62	12.54	12.67	12.62	12.54
1600	0.46	0.57	0.63	12.07	12.10	12.10	12.07	12.10	12.10
1700	0.45	0.55	0.62	11.89	11.97	12.04	11.89	11.97	12.04
1800	0.43	0.53	0.59	12.02	12.19	12.30	12.02	12.19	12.30
1900	0.39	0.49	0.54	12.45	12.69	12.84	12.45	12.69	12.84
2000	0.34	0.44	0.50	13.03	13.30	13.48	13.03	13.30	13.48
2100	0.30	0.40	0.45	13.85	14.15	14.34	13.85	14.15	14.34
2200	0.25	0.35	0.40	14.92	15.24	15.47	14.92	15.24	15.47
2300	0.21	0.31	0.37	16.06	16.43	16.68	16.06	16.43	16.68
2400	0.17	0.28	0.33	17.52	17.91	18.21	17.52	17.91	18.21
2600	0.11	0.22	0.28	21.55	21.98	22.34	21.55	21.98	22.34
2800	0.08	0.19	0.25	27.84	28.18	28.19	27.84	28.18	28.19
3000	0.06	0.18	0.25	29.89	28.55	28.16	29.89	28.55	28.16
3200	0.07	0.20	0.26	23.83	23.17	23.24	23.83	23.17	23.24
3400	0.09	0.22	0.29	19.89	19.59	19.70	19.89	19.59	19.70
3600	0.12	0.25	0.32	17.63	17.45	17.55	17.63	17.45	17.55
3800	0.16	0.29	0.36	15.92	15.79	15.86	15.92	15.79	15.86
4000	0.20	0.34	0.41	14.68	14.49	14.55	14.68	14.49	14.55
4200	0.23	0.38	0.47	13.81	13.62	13.66	13.81	13.62	13.66
4400	0.27	0.43	0.52	13.10	12.90	12.90	13.10	12.90	12.90
4600	0.31	0.48	0.57	12.53	12.32	12.25	12.53	12.32	12.25
4800	0.33	0.51	0.62	12.20	12.00	11.87	12.20	12.00	11.87
5000	0.36	0.55	0.67	11.88	11.70	11.51	11.88	11.70	11.51
5200	0.40	0.58	0.71	11.65	11.49	11.26	11.65	11.49	11.26
5400	0.40	0.59	0.73	11.62	11.46	11.19	11.62	11.46	11.19
5600	0.41	0.61	0.76	11.57	11.46	11.18	11.57	11.46	11.18
6000	0.41	0.61	0.77	11.80	11.80	11.47	11.80	11.80	11.47
6500	0.40	0.60	0.76	12.73	12.92	12.72	12.73	12.92	12.72

## Typical Performance Data

FREQ.  (MHz)	GROUP DELAY		
	(nsec)		
	@-55°C	@+25°C	@+125°C
730	1.81	1.74	1.66
750	1.58	1.52	1.47
800	1.18	1.15	1.12
850	0.95	0.94	0.93
900	0.82	0.82	0.81
950	0.74	0.74	0.74
1000	0.68	0.68	0.67
1050	0.62	0.62	0.61
1100	0.57	0.56	0.56
1150	0.52	0.51	0.51
1200	0.47	0.46	0.46
1250	0.42	0.42	0.41
1300	0.38	0.38	0.37
1350	0.35	0.34	0.34
1400	0.32	0.31	0.31
1450	0.29	0.29	0.29
1500	0.27	0.27	0.27
1600	0.23	0.23	0.23
1700	0.21	0.21	0.21
1800	0.19	0.19	0.19
1900	0.17	0.17	0.18
2000	0.16	0.16	0.16
2100	0.15	0.15	0.15
2200	0.14	0.14	0.15
2300	0.14	0.14	0.14
2400	0.13	0.13	0.13
2500	0.13	0.13	0.13
2800	0.11	0.11	0.11
3100	0.10	0.10	0.10
3400	0.09	0.09	0.09
3700	0.08	0.08	0.09
4000	0.08	0.08	0.08
4300	0.08	0.08	0.08
4600	0.07	0.07	0.08
4900	0.07	0.07	0.07
5000	0.07	0.07	0.07
5200	0.07	0.07	0.07
5400	0.07	0.07	0.08
6000	0.08	0.08	0.08
6500	0.09	0.09	0.09

## Typical Performance Curves

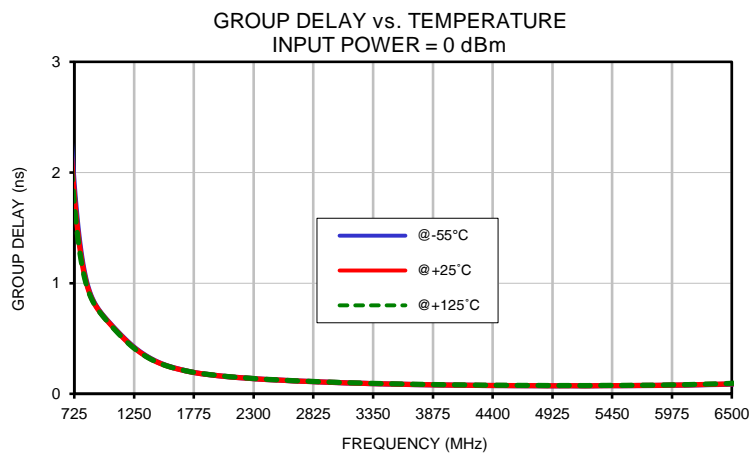
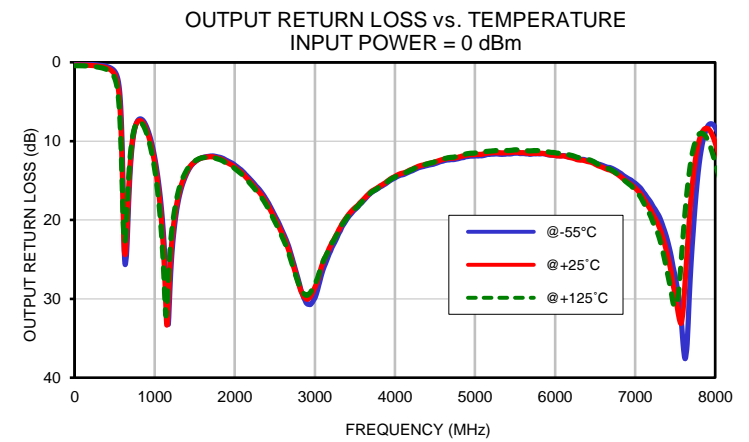
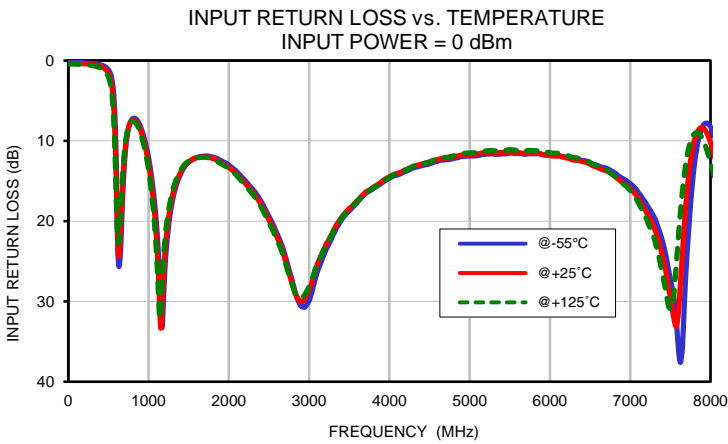
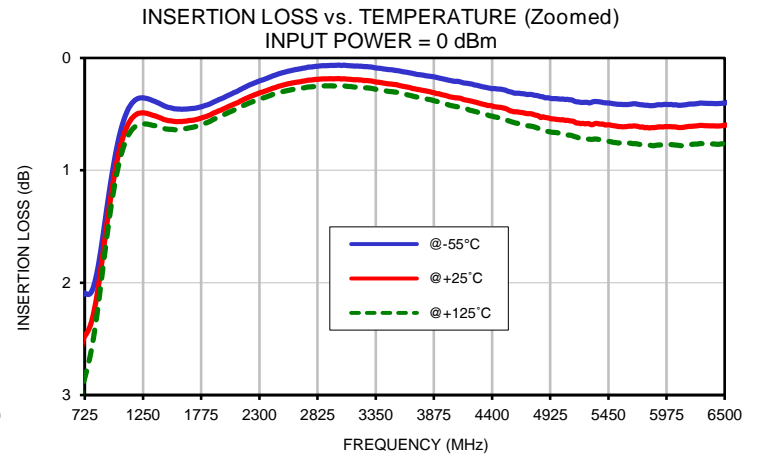
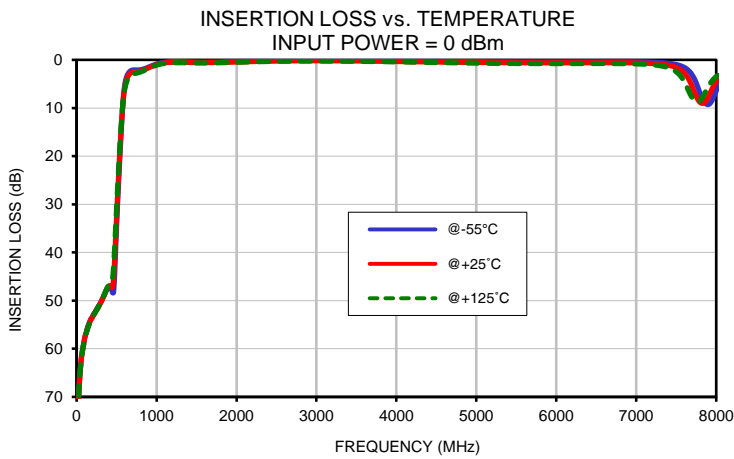



### Outline Dimensions

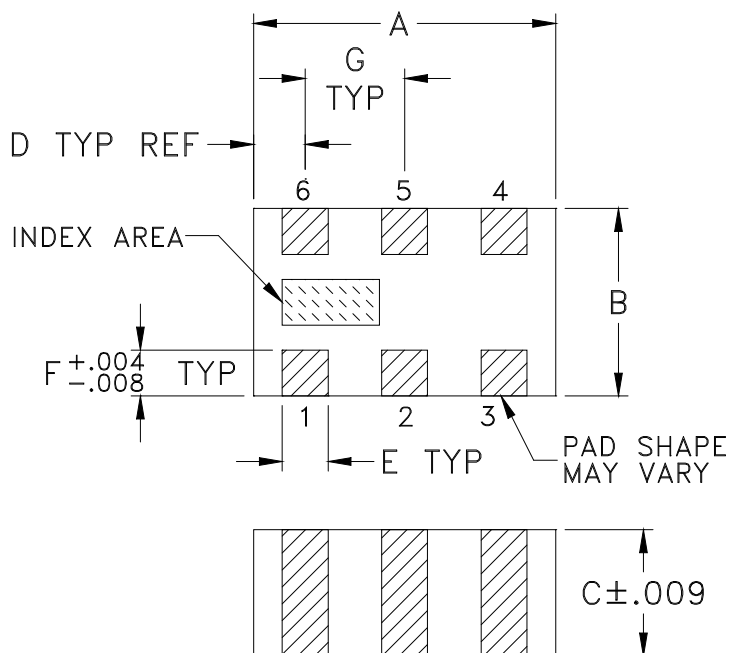

### PCB Land Pattern

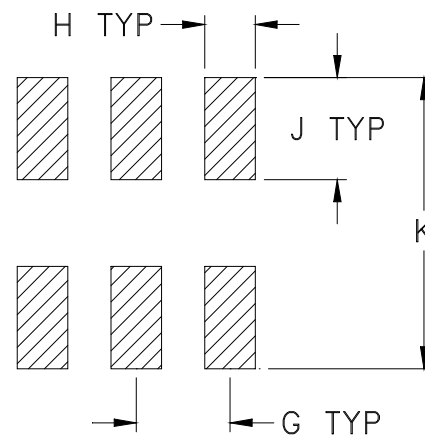

Suggested Layout,  
Tolerance to be within  $\pm 0.002$

CASE #	A	B	C	D	E	F	G	H	J	K	WT.GRAM
GE0805C-9	.079 (2.00)	.049 (1.25)	.037 (0.95)	.014 (0.35)	.012 (0.30)	.012 (0.30)	.026 (0.65)	.014 (0.35)	.039 (1.00)	.110 (2.80)	.008

Dimensions are in inches (mm). Tolerances: 2Pl.  $\pm .01$ ; 3 Pl.  $\pm .005$

### Notes:

- Open style, ceramic base.
- Termination finish: For RoHS Case Styles: Tin plate over Nickel plate. All models, (+) suffix.  
For RoHS-5 Case Styles: Tin-Lead plate over Nickel plate. All models, no (+) suffix.



P.O. Box 350166, Brooklyn, New York 11235-0003 (718) 934-4500 Fax (718) 332-4661 For detailed performance specs & shopping online see Mini-Circuits web site



The Design Engineers Search Engine Provides ACTUAL Data Instantly From MINI-CIRCUITS At: [www.minicircuits.com](http://www.minicircuits.com)

RF/IF MICROWAVE COMPONENTS

# Tape & Reel Packaging TR-F114

## DEVICE ORIENTATION IN T&R

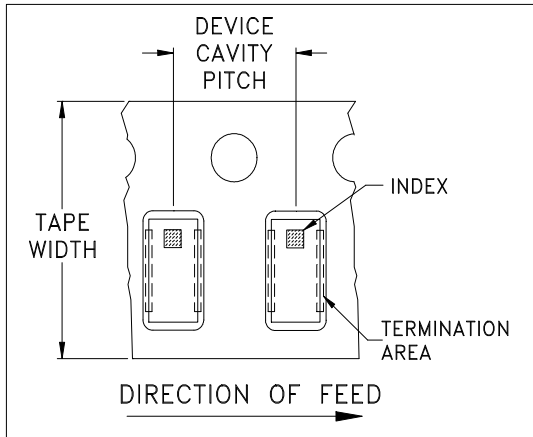

ILLUSTRATION 1

Applicable Case Styles	
GE0805C	JC0603C
GE0805C-1	JC0603C-4
GE0805C-1AP	JC0603C-6
GE0805C-7	
GE0805C-9	
GE0805C-10	
GE0805C-11	
GE0805C-12	

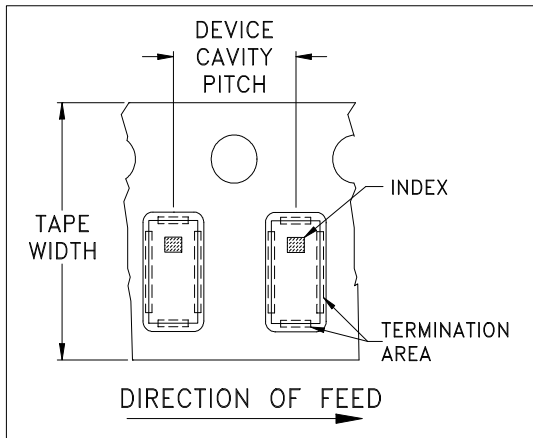

ILLUSTRATION 2

Applicable Case Styles	
GE0805C-2	JC0603C-1
GE0805C-3	JC0603C-2
GE0805C-4	JC0603C-3
GE0805C-5	JC0603C-5
GE0805C-6	JC0603C-7
GE0805C-8	JV1210C-1
GE0805C-15	

Tape Width, mm	Device Cavity Pitch, mm	Reel Size, inches	Devices per Reel	
8	4	7	Small quantity standards (see note)	20
				50
				100
				200
				500
				1000
			Standard	4000

Note: Please Consult individual model data sheet to determine device per reel availability.

Mini-Circuits carrier tape materials provide protection from ESD (Electro-Static Discharge) during handling and transportation. Tapes are static dissipative and comply with industry standards EIA-481/EIA-541.

Go to: [www.minicircuits.com/pages/pdfs/tape.pdf](http://www.minicircuits.com/pages/pdfs/tape.pdf)



INTERNET <http://www.minicircuits.com>

P.O. Box 350166, Brooklyn, New York 11235-0003 (718) 934-4500 Fax (718) 332-4661

Distribution Centers NORTH AMERICA 800-654-7949 • 417-335-5935 • Fax 417-335-5945 • EUROPE 44-1252-832600 • Fax 44-1252-837010

Mini-Circuits ISO 9001 & ISO 14001 Certified

THIRD ANGLE PROJECTION

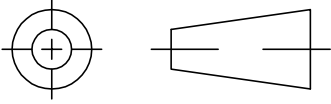

REVISIONS

REV OR	ECN No.	DESCRIPTION	DATE	DR	AUTH
	M174039	NEW RELEASE	MAY 19	DDR	VC

SUGGESTED MOUNTING CONFIGURATION FOR  
GE0805C-9 CASE STYLE "06FL02" PIN CODE

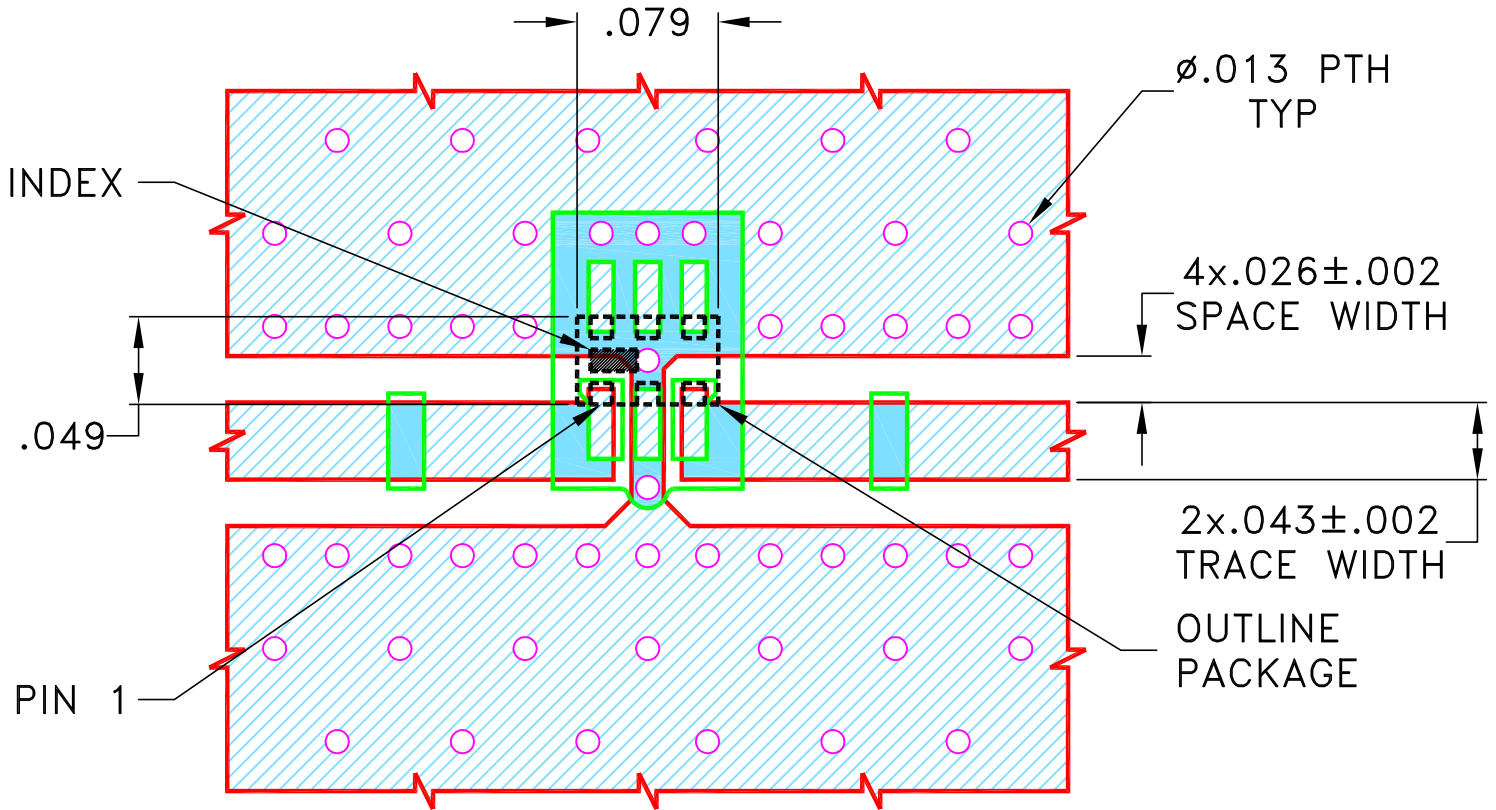

NOTES:

1. TRACE WIDTH IS SHOWN FOR ROGERS (R04350B) WITH DIELECTRIC THICKNESS .020"±.0015". COPPER: 1/2 Oz. EACH SIDE.  
FOR OTHER MATERIALS TRACE WIDTH MAY NEED TO BE MODIFIED.
2. BOTTOM SIDE OF THE PCB IS CONTINUOUS GROUND PLANE.



DENOTES PCB COPPER LAYOUT WITH SMOBC  
(SOLDER MASK OVER BARE COPPER)



DENOTES COPPER LAND PATTERN FREE OF SOLDERMASK

UNLESS OTHERWISE SPECIFIED	INITIALS	DATE
DIMENSIONS ARE IN INCHES	DRAWN: DDR	08 MAY 19
TOLERANCES ON:	CHECKED: RV	08 MAY 19
2 PL DECIMALS ±	APPROVED: RKS	08 MAY 19
3 PL DECIMALS ± .005"		
ANGLES ±		
FRACTIONS ±		



**Mini-Circuits®** 13 Neptune Avenue  
Brooklyn NY 11235

PL, 06FL02, GE0805C-9  
TB-1104+, 50 OHM

Mini-Circuits®  
THIS DOCUMENT AND ITS CONTENTS ARE THE PROPERTY OF MINI-CIRCUITS. EXCEPT FOR USE EXPRESSLY GRANTED, IN WRITING, TO ITS VENDORS, VENDEE AND THE UNITED STATES GOVERNMENT, MINI-CIRCUITS RESERVES ALL PROPRIETARY DESIGN, USE, MANUFACTURING AND REPRODUCTION RIGHTS THERETO. THESE CONTENTS SHALL NOT BE USED, DUPLICATED OR DISCLOSED TO ANY OUTSIDE PARTY, IN WHOLE OR IN PART, WITHOUT WRITTEN PERMISSION OF MINI-CIRCUITS.

ASHEETA1.DWG REV:A DATE:01/12/95

SIZE A	CODE IDENT 15542	DRAWING NO: 98-PL-633	REV: OR
FILE: 98PL633	SCALE: 9:1	SHEET: 1 OF 1	

# Evaluation Board and Circuit

TB-HFCG-650+

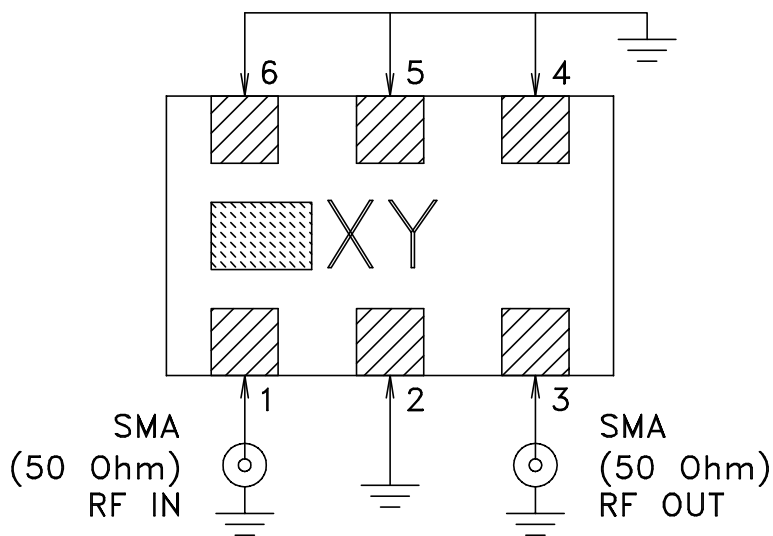
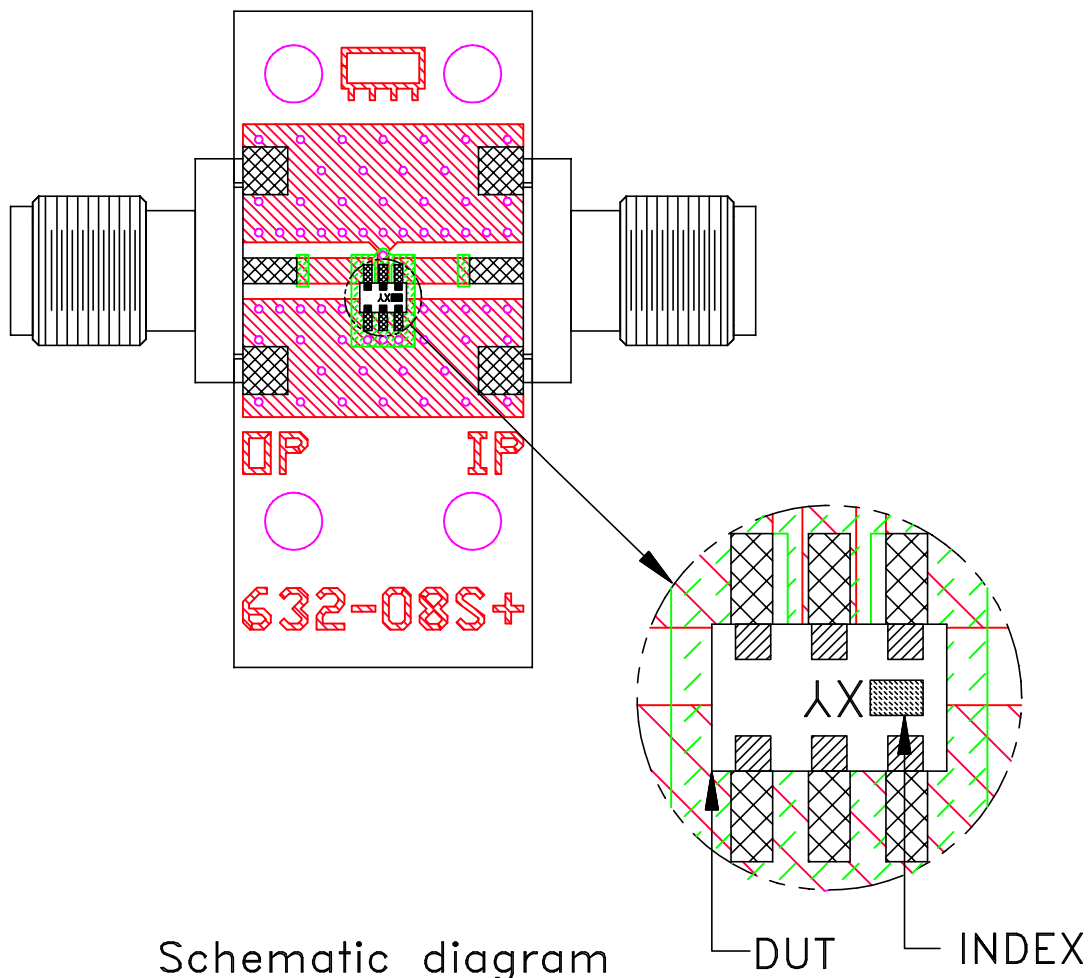

**Notes:**

1. PCB Material: ROGERS (R04350B) OR Equivalent, Dielectric Constant= $3.48 \pm 0.05$   
Dielectric Thickness:  $.020 \pm .0015$  inch
2. 50 Ohm SMA Female Connectors.

 **Mini-Circuits®**



All Mini-Circuits products are manufactured under exacting quality assurance and control standards, and are capable of meeting published specifications after being subjected to any or all of the following physical and environmental test.

Specification	Test/Inspection Condition	Reference/Spec
Operating Temperature	-55° to 125° C Ambient Environment	Individual Model Data Sheet
Storage Temperature	-55° to 125° C Ambient Environment	Individual Model Data Sheet
Humidity	90 to 95% RH, 240 hours, 50°C	MIL-STD-202, Method 103, Condition A, Except 50°C and end-point electrical test done within 12 hours
Solder Reflow Heat	Sn-Pb Eutetic Process: 225°C peak Pb-Free Process 245° - 250°C peak	J-STD-020, Table 4-1, 4-2 and 5-2, Figure 5-1
Solderability	10X Magnification	J-STD-002, Test B,B1, 95% Coverage
Thermal Shock	-40° to +125°C, 15 min dwell, 100 cycles	MIL-STD-202, Method 107
Bend Test	1mm, deflection for 5 seconds Span of bending: 2.75"	--
High Temp Storage	125°C to 1000 Hrs	---