

Miniature Plastic Fixed Attenuator

50Ω 0.5W 7dB DC to 8000 MHz

GAT-7+



Generic photo used for illustration purposes only

CASE STYLE: FG873

+RoHS Compliant

The +Suffix identifies RoHS Compliance. See our web site for RoHS Compliance methodologies and qualifications

Available Tape and Reel at no extra cost

Reel Size	Devices/Reel
7"	20, 50, 100, 200, 500, 1000
13"	2000, 3000, 4000

Maximum Ratings

Operating Temperature	-45°C to 85°C
Storage Temperature	-55°C to 100°C

Permanent damage may occur if any of these limits are exceeded.

Pin Connections

INPUT	1
OUTPUT	3
GROUND	2,4

Product Marking

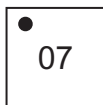

Outline Drawing

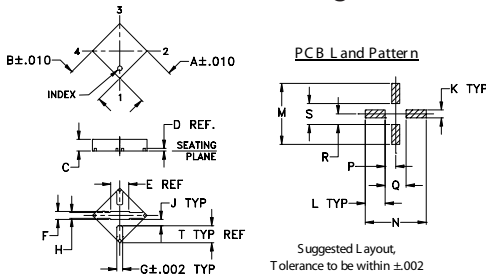

Outline Dimensions (inch/mm)

A	B	C	D	E	F	G	H	J		
0.118	0.118	0.035	0.008	0.07	0.024	0.017	0.018	0.021		
3.00	3.00	0.89	0.20	1.78	0.61	0.43	0.46	0.53		
K	L	M	N	P	Q	R	S	T	wt	
0.024	0.061	0.186	0.186	0.032	0.064	0.032	0.064	0.05	grams	
0.61	1.55	4.72	4.72	0.81	1.63	0.81	1.63	1.27	0.02	

Demo Board MCL P/N: TB-154 Suggested PCB Layout (PL-126)

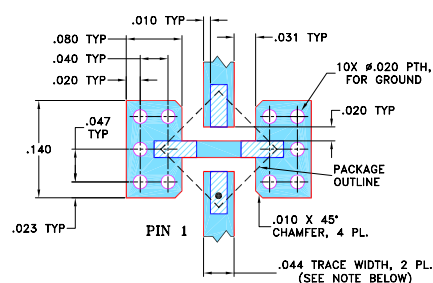

Features

- miniature package MCLP™ 3x3 mm
- specified to 8000 MHz, useable to 10000 MHz
- excellent VSWR, 1:15:1 typ.

Applications

- cellular
- PCS
- communications
- radar
- defense

Electrical Specifications at 25°C

FREQ. RANGE (MHz)	ATTENUATION (dB) Flatness	VSWR (:1)			MAX. INPUT POWER ¹ (W)	
		DC-1 GHz	1-5 GHz	5-8 GHz		
f_L - f_U	Nom.	Typ. Max.	Typ. Max.	Typ.		
DC-8000	7±0.3	0.1	0.2	0.3	1.05 1.2 1.15 1.3 1.35	0.5

1. RF power at 25°C case temperature: ½Watt. Derate linearly to 0.2 Watt at 85°C.
2. Flatness= variation over band divided by 2

Typical Performance Data

Frequency (MHz)	Attenuation (dB)	VSWR (:1)
100.00	6.91	1.02
500.00	6.98	1.03
1000.00	7.03	1.04
2000.00	7.11	1.05
3000.00	7.15	1.08
4000.00	7.33	1.08
5000.00	7.41	1.08
6000.00	7.49	1.11
7000.00	7.87	1.18
8000.00	7.96	1.32

GAT-7+ ATTENUATION

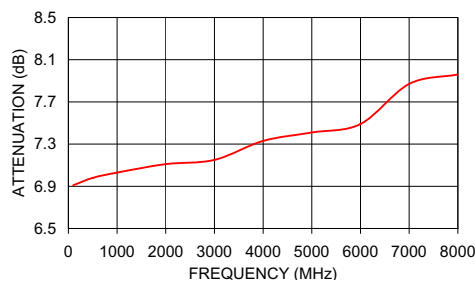

GAT-7+ VSWR

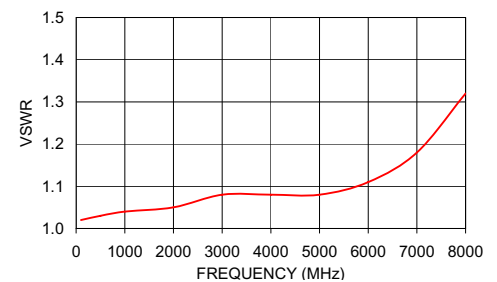

Notes

- A. Performance and quality attributes and conditions not expressly stated in this specification document are intended to be excluded and do not form a part of this specification document.
- B. Electrical specifications and performance data contained in this specification document are based on Mini-Circuit's applicable established test performance criteria and measurement instructions.
- C. The parts covered by this specification document are subject to Mini-Circuits standard limited warranty and terms and conditions (collectively, "Standard Terms"); Purchasers of this part are entitled to the rights and benefits contained therein. For a full statement of the Standard Terms and the exclusive rights and remedies thereunder, please visit Mini-Circuits' website at www.minicircuits.com/MCLStore/terms.jsp



Typical Performance Data

FREQUENCY (MHz)	ATTENUATION (dB)	RETURN LOSS (dB)
100.00	6.91	40.09
500.00	6.98	36.61
1000.00	7.03	34.15
2000.00	7.11	32.26
3000.00	7.15	28.30
4000.00	7.33	28.30
5000.00	7.41	28.30
6000.00	7.49	25.66
7000.00	7.87	21.66
8000.00	7.96	17.21

REV. X1
GAT-7+
061107
Page 1 of 1



IF/RF MICROWAVE COMPONENTS • ISO 9001 ISO 14001 AS 9100 CERTIFIED RoHS compliant
P.O. Box 350166, Brooklyn, New York 11235-0003 (718) 934-4500 Fax (718) 332-4661



2 The Design Engineers Search Engine finds the model you need, Instantly • For detailed performance specs & shopping online see



Typical Performance Curves

Attenuation

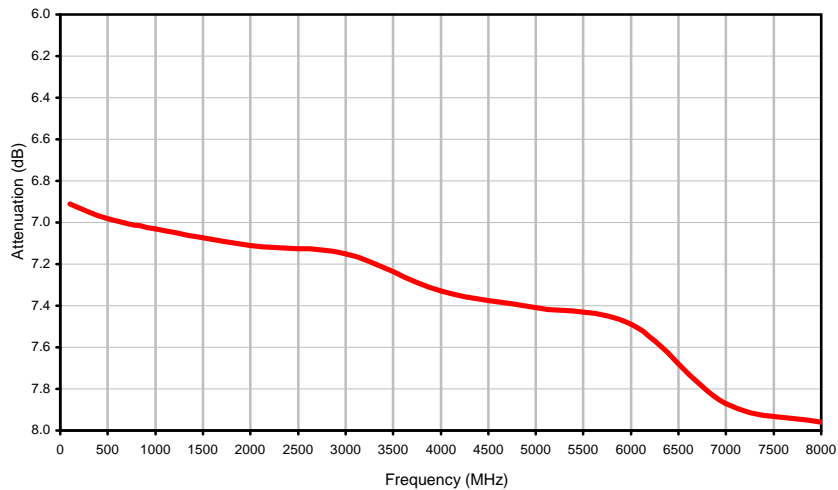

Return Loss

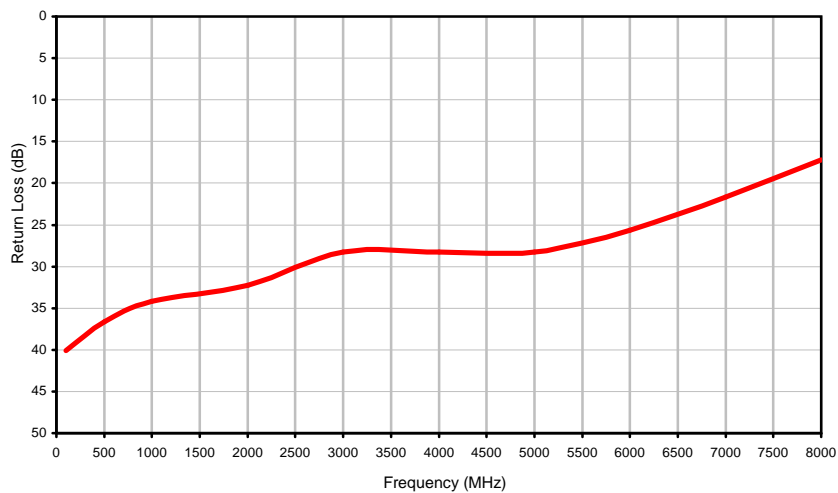

Outline Dimensions

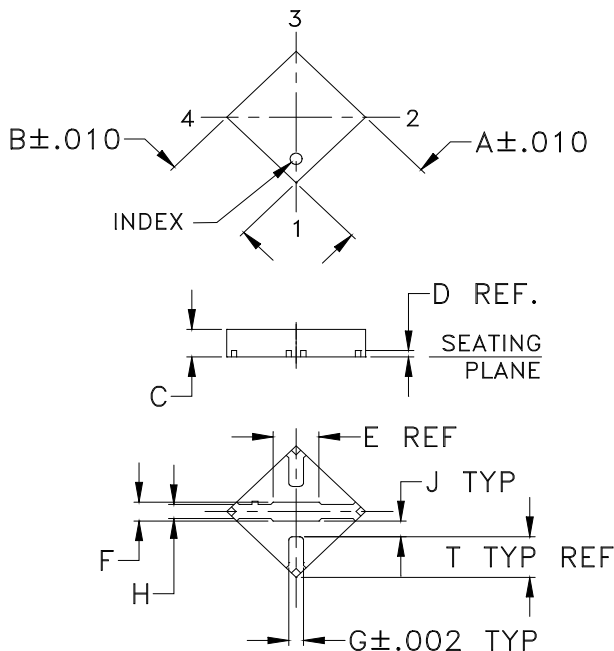

PCB Land Pattern

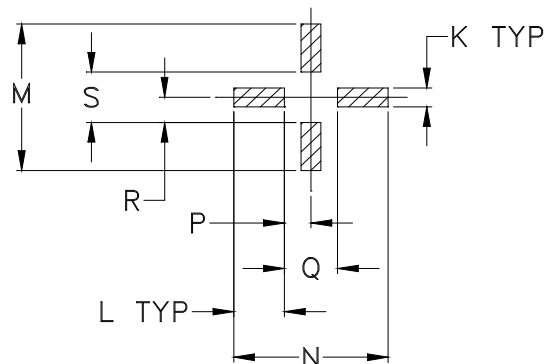

Suggested Layout,
Tolerance to be within $\pm .002$

CASE #	A	B	C	D	E	F	G	H	J	K	L	M	N	P
FG873	.118 (3.00)	.118 (3.00)	.035 (0.89)	.008 (0.20)	.07 (1.78)	.024 (0.60)	.017 (0.43)	.018 (0.46)	.021 (0.52)	.024 (0.61)	.061 (1.55)	.186 (4.72)	.186 (4.72)	.032 (0.81)

CASE #	Q	R	S	T	WT. GRAM
FG873	.064 (1.63)	.032 (0.81)	.064 (1.63)	.050 (1.27)	.02

Dimensions are in inches (mm). Tolerances: 2 Pl. $\pm .01$; 3Pl. $\pm .004$

Notes:

- Case material: Plastic.
- Termination finish:
For RoHS Case Styles: Tin-Silver alloy plate over Nickel barrier or Matte-Tin per Data Sheet.
All models, (+) suffix.
For RoHS-5 Case Styles: Tin-Lead plate. All models, no (+) suffix.



P.O. Box 350166, Brooklyn, New York 11235-0003 (718) 934-4500 Fax (718) 332-4661 For detailed performance specs & shopping online see Mini-Circuits web site



The Design Engineers Search Engine Provides ACTUAL Data Instantly From MINI-CIRCUITS At: www.minicircuits.com

RF/IF MICROWAVE COMPONENTS

Tape & Reel Packaging TR-F68

DEVICE ORIENTATION IN T&R

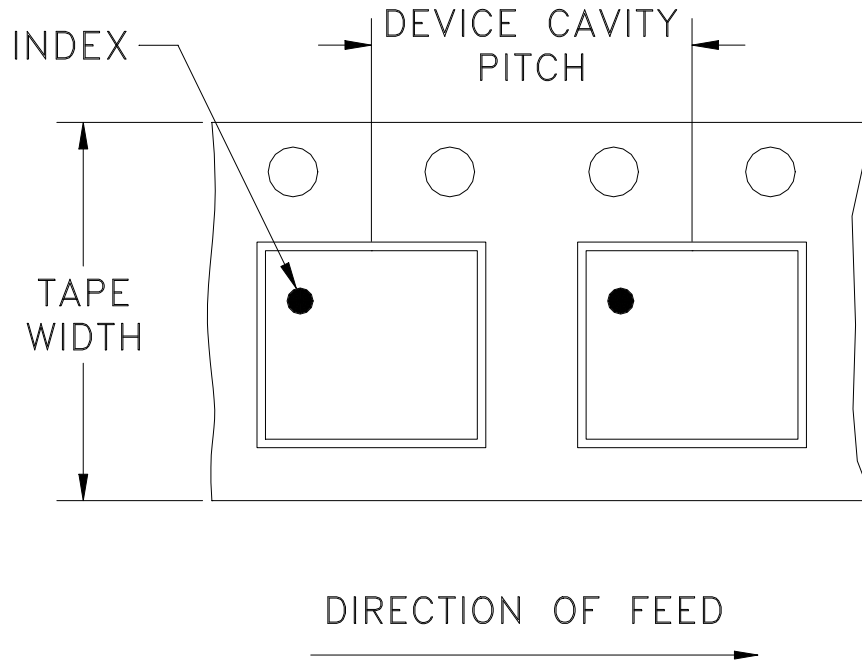

Tape Width, mm	Device Cavity Pitch, mm	Reel Size, inches	Devices per Reel see note	
12	8	7	Small quantity standard	20
				50
				100
				200
				500
		7	Standard	1000
		13	Standard	2000
				3000
4000				

Mini-Circuits carrier tape materials provide protection from ESD (Electro-Static Discharge) during handling and transportation. Tapes are static dissipative and comply with industry standards EIA-481/EIA-541.

Go to: www.minicircuits.com/pages/pdfs/tape.pdf



INTERNET <http://www.minicircuits.com>

P.O. Box 350166, Brooklyn, New York 11235-0003 (718) 934-4500 Fax (718) 332-4661

Distribution Centers NORTH AMERICA 800-654-7949 • 417-335-5935 • Fax 417-335-5945 • EUROPE 44-1252-832600 • Fax 44-1252-837010

Mini-Circuits ISO 9001 & ISO 14001 Certified

THIRD ANGLE PROJECTION

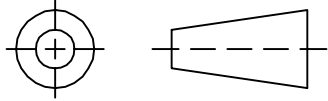

REVISIONS

REV	ECN No.	DESCRIPTION	DATE	DR	AUTH
OR	M85378	NEW RELEASE	02/12/03	MMG	MM
A	M102713	ADDED "... WITH SMOBC"	10/27/06	MMG	MM
B	M108435	REMOVED "CB" PIN CONN AND "LEE"	11/14/06	PW	IG

SUGGESTED MOUNTING CONFIGURATION
FOR FG873 CASE STYLE, "hl" PIN CONNECTION

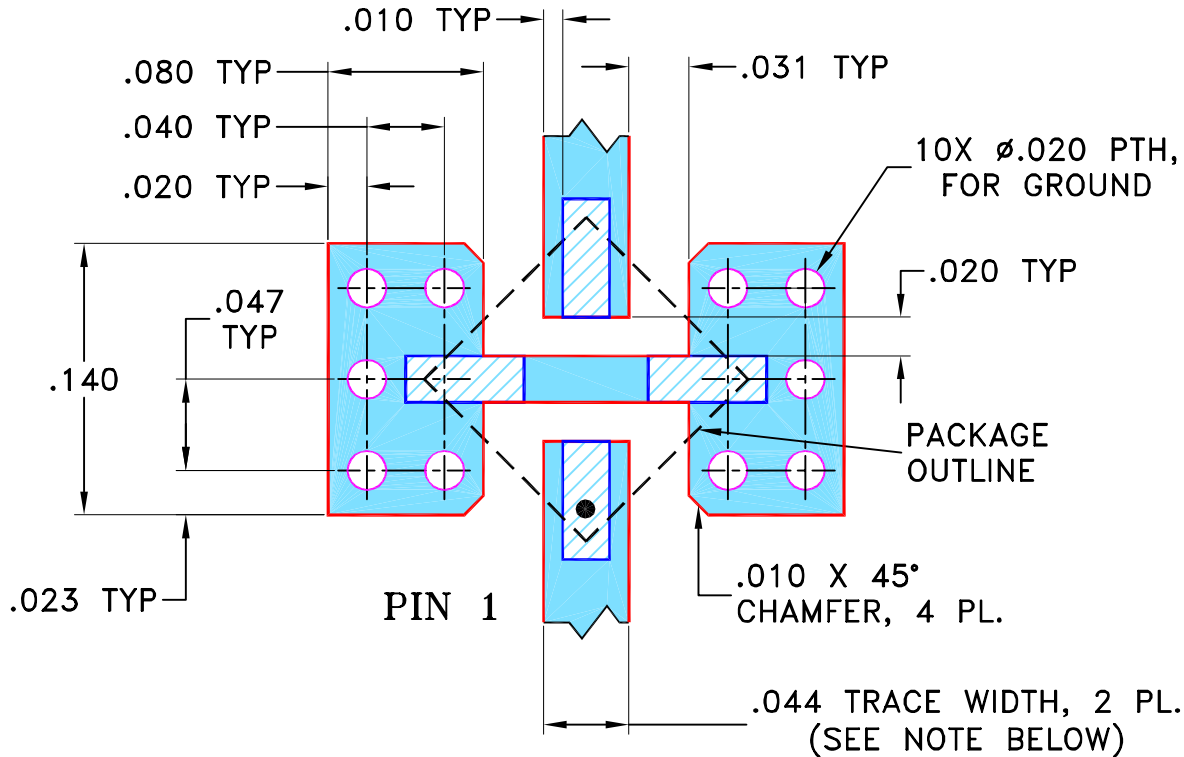

NOTES:

1. TRACE WIDTH IS SHOWN FOR ROGERS RO4350B WITH DIELECTRIC THICKNESS .020" ± .0015"; COPPER: 1/2 OZ. EACH SIDE. FOR OTHER MATERIALS TRACE WIDTH MAY NEED TO BE MODIFIED.
2. BOTTOM SIDE OF THE PCB IS CONTINUOUS GROUND PLANE.



DENOTES PCB COPPER LAYOUT WITH SMOBC (SOLDER MASK OVER BARE COPPER)

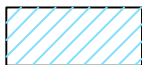

DENOTES COPPER LAND PATTERN FREE OF SOLDER MASK

UNLESS OTHERWISE SPECIFIED	INITIALS	DATE
DIMENSIONS ARE IN INCHES TOLERANCES ON: 2 PL DECIMALS ± 3 PL DECIMALS ± .005 ANGLES ± FRACTIONS ±	DRAWN	MMG 02/06/03
	CHECKED	AV 02/10/03
	APPROVED	MM 02/12/03



Mini-Circuits®

13 Neptune Avenue
Brooklyn NY 11235

PL, hl, FG873, GAT, TB-154

Mini-Circuits®
THIS DOCUMENT AND ITS CONTENTS ARE THE PROPERTY OF MINI-CIRCUITS. EXCEPT FOR USE EXPRESSLY GRANTED, IN WRITING, TO ITS VENDORS, VENDEE AND THE UNITED STATES GOVERNMENT, MINI-CIRCUITS RESERVES ALL PROPRIETARY DESIGN, USE, MANUFACTURING AND REPRODUCTION RIGHTS THERETO. THESE CONTENTS SHALL NOT BE USED, DUPLICATED OR DISCLOSED TO ANY OUTSIDE PARTY, IN WHOLE OR IN PART, WITHOUT WRITTEN PERMISSION OF MINI-CIRCUITS.

SIZE A	CODE IDENT 15542	DRAWING NO: 98-PL-126	REV: B
FILE: 98PL126	SCALE: 10:1	SHEET: 1 OF 1	

Characterization Test Board

For Pins Connections refer to Data Sheet of the DUT

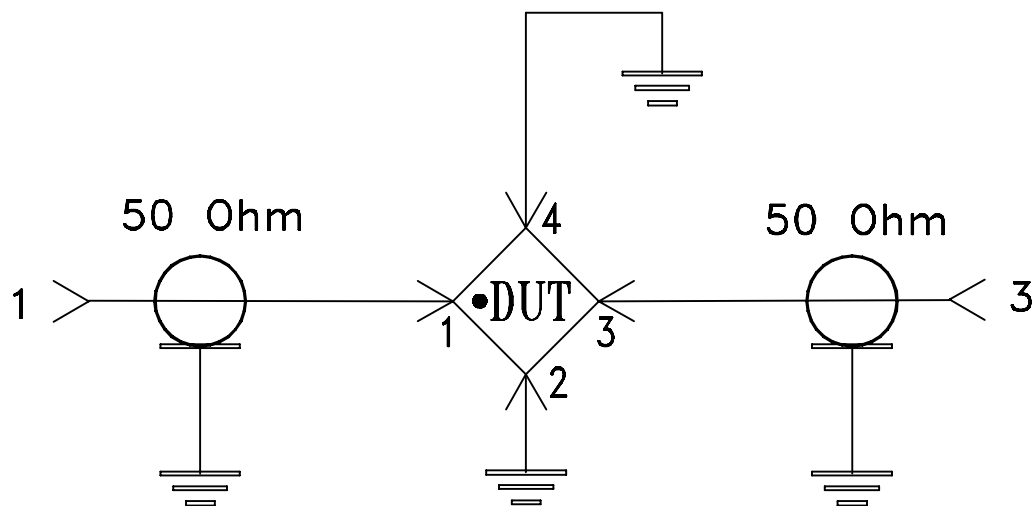
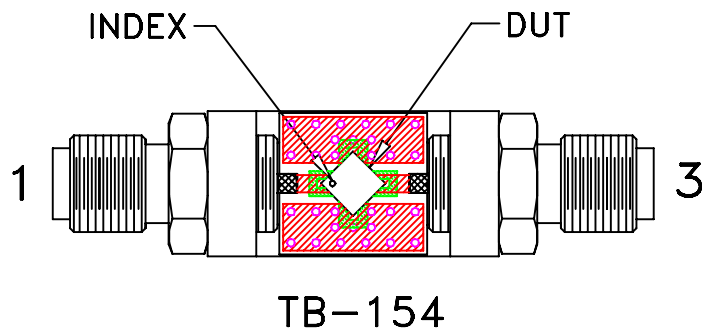

Schematic Diagram

Notes:

1. SMA Female connectors.
2. PCB Material: Rogers R04350 or equivalent,
Dielectric Constant=3.5, Thickness=.020 inch.

 Mini-Circuits®

All Mini-Circuits products are manufactured under exacting quality assurance and control standards, and are capable of meeting published specifications after being subjected to any or all of the following physical and environmental test.

Specification	Test/Inspection Condition	Reference/Spec
Operating Temperature	-45° to 85°C or -40° to 85°C Ambient Environment	Individual Model Data Sheet
Storage Temperature	-55° to 100° C Ambient Environment	Individual Model Data Sheet
Thermal Shock	-55° to 100°C, 100 cycles	MIL-STD-202, Method 107, Condition A-3, except +100°C
Mechanical Shock	1.5Kg, 0.5 ms, 5 shock pulses, Y1 direction only	MIL-STD-883, Method 2002, Condition B, except Y1 direction only
Vibration (Variable Frequency)	50g peak	MIL-STD-883, Method 2007, Condition B
Autoclave	15 psig, 100% RH, 121°C, 96 hours	JESD22-A102, Condition C
HAST	130°C, 85% RH, 96 hours	JESD22-A110
Solderability	10X Magnification	J-STD-002, Para 4.2.5, Test S, 95% Coverage
Solder Reflow Heat	Sn-Pb Eutetic Process: 240°C peak Pb-Free Process: 260°C peak	J-STD-020, Table 4-1, 4-2 and 5-2; Figure 5-1
Moisture Sensitivity: Level 1	Bake at 125°C for 24 hours Soak at 85°C/85% RH for 168 hours, Reflow 3 cycles at 260°C peak	J-STD-020
Marking Resistance to Solvents	Isopropyl alcohol + mineral spirits at 25°C; terpene defluxer at 25°C; distilled water + proylene glycol monomethyl ether +	MIL-STD-202, Method 215

All Mini-Circuits products are manufactured under exacting quality assurance and control standards, and are capable of meeting published specifications after being subjected to any or all of the following physical and environmental test.

Specification	Test/Inspection Condition	Reference/Spec
	monoethanolamine at 63°C to 70°C	