

# Miniature Plastic Fixed Attenuator

50Ω 0.5W 5dB DC to 8000 MHz

## GAT-5+



CASE STYLE: FG873

### Maximum Ratings

Operating Temperature	-45°C to 85°C
Storage Temperature	-55°C to 100°C

Permanent damage may occur if any of these limits are exceeded.

### Pin Connections

INPUT	1
OUTPUT	3
GROUND	2,4

### Product Marking

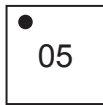

### Outline Drawing

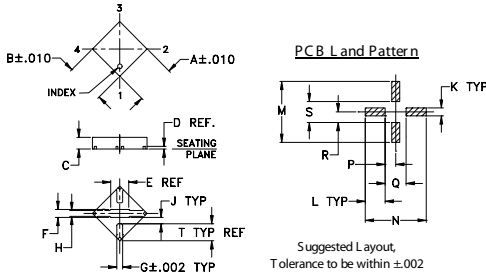

### Outline Dimensions (inch/mm)

A	B	C	D	E	F	G	H	J		
0.118	0.118	0.035	0.008	0.07	0.024	0.017	0.018	0.021		
3.00	3.00	0.89	0.20	1.78	0.61	0.43	0.46	0.53		
K	L	M	N	P	Q	R	S	T	wt	
0.024	0.061	0.186	0.186	0.032	0.064	0.032	0.064	0.05	grams	
0.61	1.55	4.72	4.72	0.81	1.63	0.81	1.63	1.27	0.02	

### Demo Board MCL P/N: TB-154 Suggested PCB Layout (PL-126)

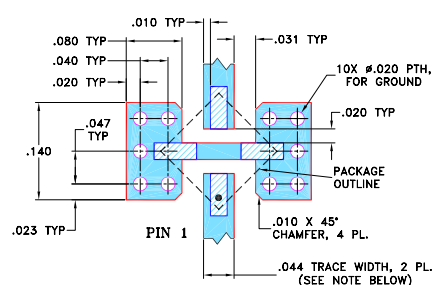

### Features

- miniature package MCLP™ 3x3 mm
- specified to 8000 MHz, useable to 10000 MHz
- excellent VSWR, 1:15:1 typ.

### Applications

- cellular
- PCS
- communications
- radar
- defense

**+RoHS Compliant**  
The +Suffix identifies RoHS Compliance. See our web site for RoHS Compliance methodologies and qualifications

Available Tape and Reel at no extra cost	
Reel Size	Devices/Reel
7"	20, 50, 100, 200, 500, 1000
13"	2000, 4000

### Electrical Specifications at 25°C

FREQ. RANGE (MHz)	ATTENUATION (dB) Flatness					VSWR (:1)					MAX. INPUT POWER <sup>1</sup> (W)	
	Nom.	DC-1	1-5	5-8	Typ.	Typ.	Max.	Typ.	Max.	Typ.		
		GHz	GHz	GHz								
f <sub>L</sub> -f <sub>U</sub>												
DC-8000	5±0.3	0.1	0.2	0.2		1.05	1.2	1.15	1.3	1.35		0.5

1. RF power at 25°C case temperature: ½Watt. Derate linearly to 0.2 Watt at 85°C.
2. Flatness= variation over band divided by 2

### Typical Performance Data

Frequency (MHz)	Attenuation (dB)	VSWR (:1)
100.00	4.93	1.03
500.00	4.99	1.04
900.00	5.05	1.04
1500.00	5.08	1.05
3000.00	5.12	1.09
4000.00	5.32	1.09
5000.00	5.34	1.05
6000.00	5.39	1.08
7000.00	5.71	1.16
8000.00	5.81	1.32

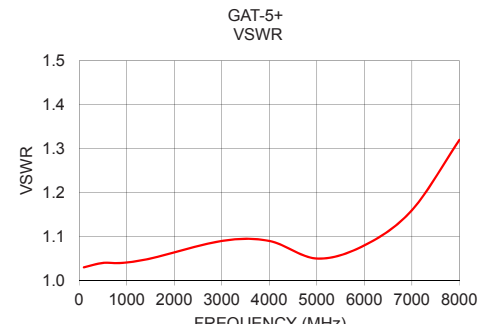
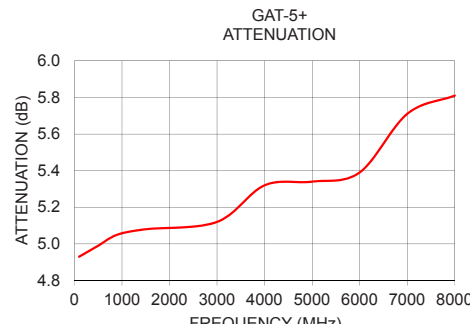

### Notes

- A. Performance and quality attributes and conditions not expressly stated in this specification document are intended to be excluded and do not form a part of this specification document.
- B. Electrical specifications and performance data contained in this specification document are based on Mini-Circuit's applicable established test performance criteria and measurement instructions.
- C. The parts covered by this specification document are subject to Mini-Circuits standard limited warranty and terms and conditions (collectively, "Standard Terms"); Purchasers of this part are entitled to the rights and benefits contained therein. For a full statement of the Standard Terms and the exclusive rights and remedies thereunder, please visit Mini-Circuits' website at [www.minicircuits.com/MCLStore/terms.jsp](http://www.minicircuits.com/MCLStore/terms.jsp)

## Typical Performance Data

FREQUENCY (MHz)	ATTENUATION (dB)	RETURN LOSS (dB)
100.00	4.93	36.61
500.00	4.99	34.15
900.00	5.05	34.15
1500.00	5.08	32.26
3000.00	5.12	27.32
4000.00	5.32	27.32
5000.00	5.34	32.26
6000.00	5.39	28.30
7000.00	5.71	22.61
8000.00	5.81	17.21

REV. X1  
GAT-5+  
061107  
Page 1 of 1



IF/RF MICROWAVE COMPONENTS • ISO 9001 ISO 14001 AS 9100 CERTIFIED RoHS compliant  
P.O. Box 350166, Brooklyn, New York 11235-0003 (718) 934-4500 Fax (718) 332-4661



The Design Engineers Search Engine finds the model you need, Instantly • For detailed performance specs & shopping online see



## Typical Performance Curves

### Attenuation

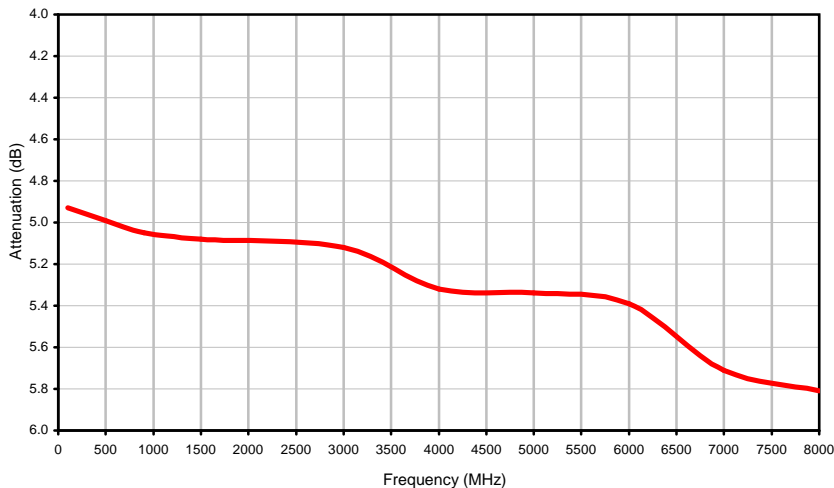

### Return Loss

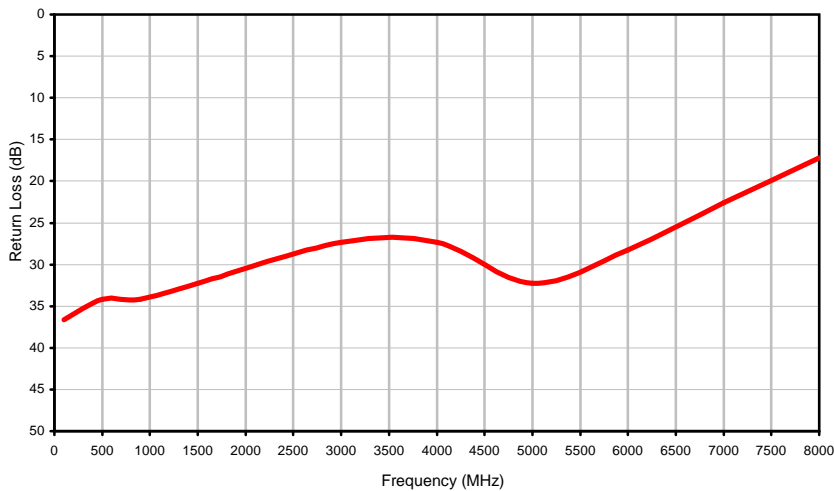

### Outline Dimensions

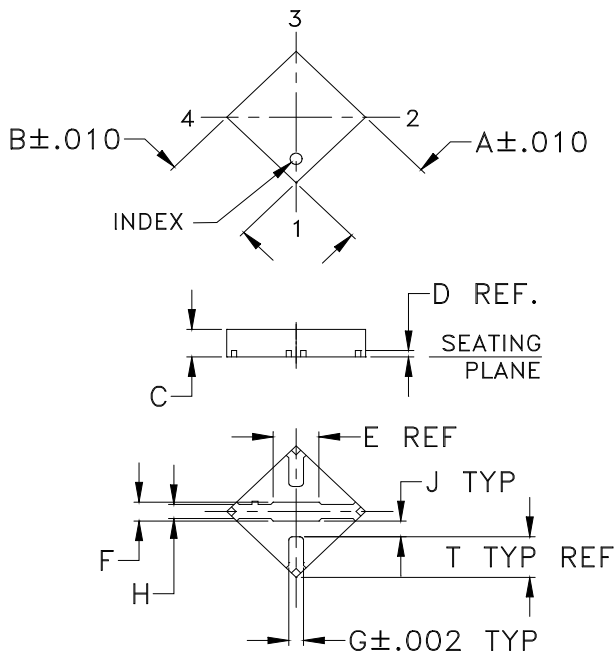

### PCB Land Pattern

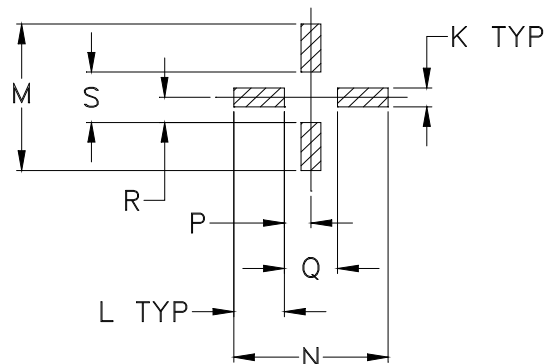

Suggested Layout,  
Tolerance to be within  $\pm .002$

CASE #	A	B	C	D	E	F	G	H	J	K	L	M	N	P
FG873	.118 (3.00)	.118 (3.00)	.035 (0.89)	.008 (0.20)	.07 (1.78)	.024 (0.60)	.017 (0.43)	.018 (0.46)	.021 (0.52)	.024 (0.61)	.061 (1.55)	.186 (4.72)	.186 (4.72)	.032 (0.81)

CASE #	Q	R	S	T	WT. GRAM
FG873	.064 (1.63)	.032 (0.81)	.064 (1.63)	.050 (1.27)	.02

Dimensions are in inches (mm). Tolerances: 2 Pl.  $\pm .01$ ; 3Pl.  $\pm .004$

#### Notes:

- Case material: Plastic.
- Termination finish:  
For RoHS Case Styles: Tin-Silver alloy plate over Nickel barrier or Matte-Tin per Data Sheet.  
All models, (+) suffix.  
For RoHS-5 Case Styles: Tin-Lead plate. All models, no (+) suffix.



P.O. Box 350166, Brooklyn, New York 11235-0003 (718) 934-4500 Fax (718) 332-4661 For detailed performance specs & shopping online see Mini-Circuits web site



The Design Engineers Search Engine Provides ACTUAL Data Instantly From MINI-CIRCUITS At: [www.minicircuits.com](http://www.minicircuits.com)

RF/IF MICROWAVE COMPONENTS

# Tape & Reel Packaging TR-F68

## DEVICE ORIENTATION IN T&R

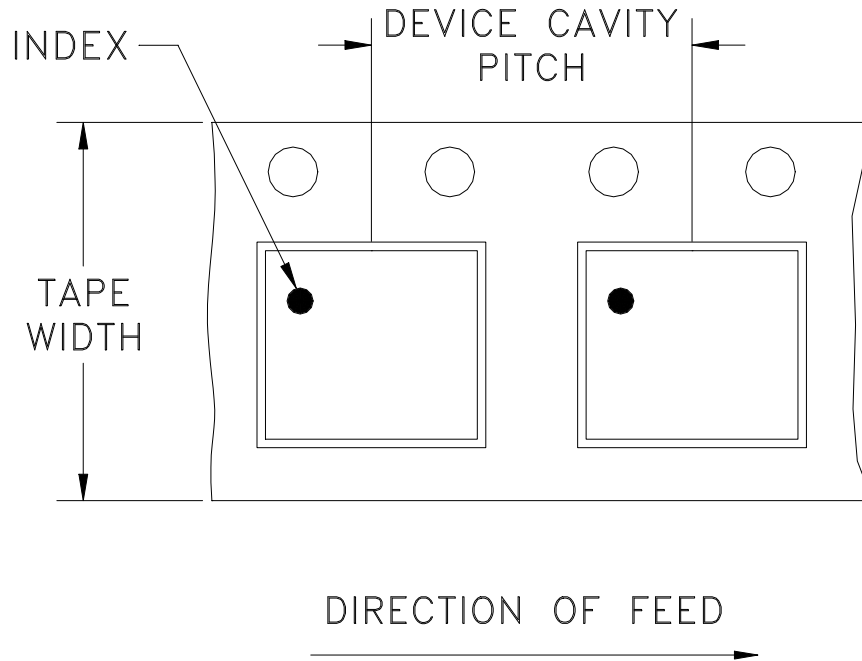

Tape Width, mm	Device Cavity Pitch, mm	Reel Size, inches	Devices per Reel see note	
12	8	7	Small quantity standard	20
				50
				100
				200
				500
		7	Standard	1000
		13	Standard	2000
				3000
				4000

Mini-Circuits carrier tape materials provide protection from ESD (Electro-Static Discharge) during handling and transportation. Tapes are static dissipative and comply with industry standards EIA-481/EIA-541.

Go to: [www.minicircuits.com/pages/pdfs/tape.pdf](http://www.minicircuits.com/pages/pdfs/tape.pdf)



INTERNET <http://www.minicircuits.com>

P.O. Box 350166, Brooklyn, New York 11235-0003 (718) 934-4500 Fax (718) 332-4661

Distribution Centers NORTH AMERICA 800-654-7949 • 417-335-5935 • Fax 417-335-5945 • EUROPE 44-1252-832600 • Fax 44-1252-837010

Mini-Circuits ISO 9001 & ISO 14001 Certified

THIRD ANGLE PROJECTION

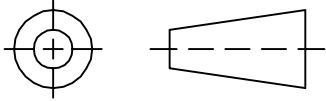

REVISIONS

REV	ECN No.	DESCRIPTION	DATE	DR	AUTH
OR	M85378	NEW RELEASE	02/12/03	MMG	MM
A	M102713	ADDED "... WITH SMOBC"	10/27/06	MMG	MM
B	M108435	REMOVED "CB" PIN CONN AND "LEE"	11/14/06	PW	IG

SUGGESTED MOUNTING CONFIGURATION  
FOR FG873 CASE STYLE, "hl" PIN CONNECTION

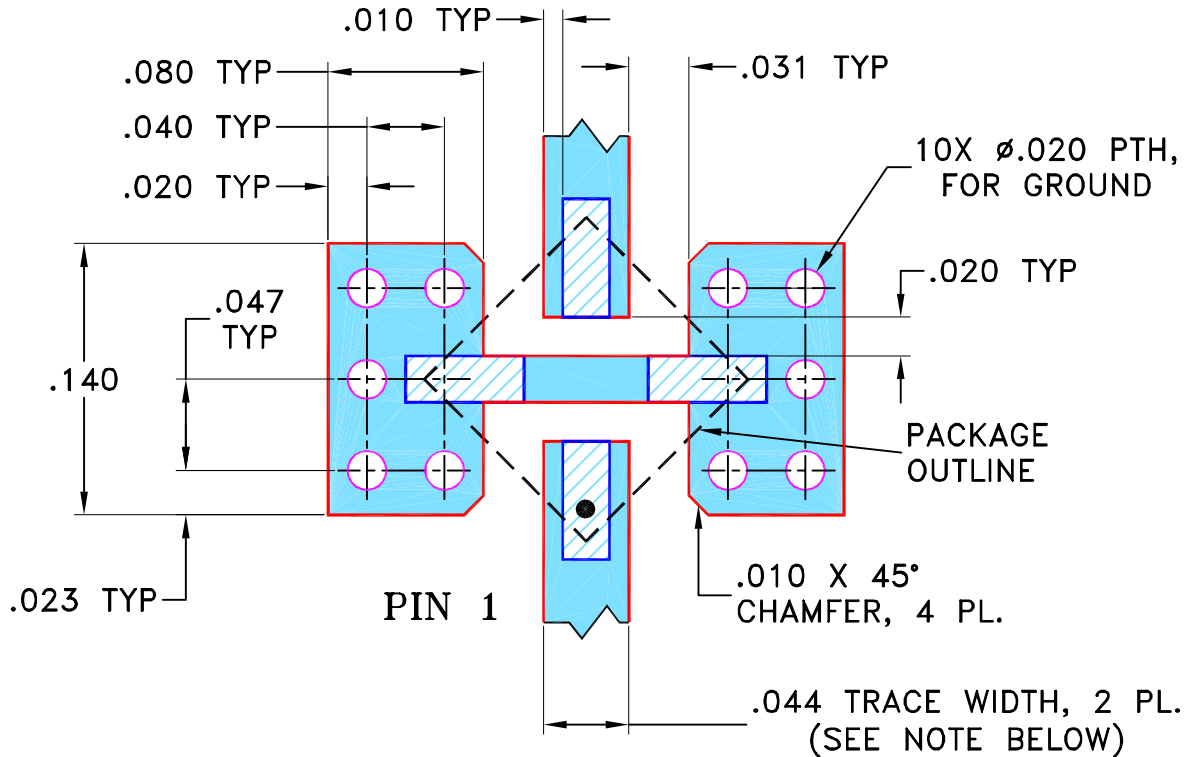

NOTES:

1. TRACE WIDTH IS SHOWN FOR ROGERS RO4350B WITH DIELECTRIC THICKNESS .020" ± .0015"; COPPER: 1/2 OZ. EACH SIDE. FOR OTHER MATERIALS TRACE WIDTH MAY NEED TO BE MODIFIED.
2. BOTTOM SIDE OF THE PCB IS CONTINUOUS GROUND PLANE.



DENOTES PCB COPPER LAYOUT WITH SMOBC (SOLDER MASK OVER BARE COPPER)

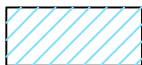

DENOTES COPPER LAND PATTERN FREE OF SOLDER MASK

UNLESS OTHERWISE SPECIFIED	INITIALS	DATE
DIMENSIONS ARE IN INCHES	DRAWN MMG	02/06/03
TOLERANCES ON:	CHECKED AV	02/10/03
2 PL DECIMALS ±	APPROVED MM	02/12/03
3 PL DECIMALS ± .005		
ANGLES ±		
FRACTIONS ±		



Mini-Circuits®

13 Neptune Avenue  
Brooklyn NY 11235

PL, hl, FG873, GAT, TB-154

Mini-Circuits®  
THIS DOCUMENT AND ITS CONTENTS ARE THE PROPERTY OF MINI-CIRCUITS. EXCEPT FOR USE EXPRESSLY GRANTED, IN WRITING, TO ITS VENDORS, VENDEE AND THE UNITED STATES GOVERNMENT, MINI-CIRCUITS RESERVES ALL PROPRIETARY DESIGN, USE, MANUFACTURING AND REPRODUCTION RIGHTS THERETO. THESE CONTENTS SHALL NOT BE USED, DUPLICATED OR DISCLOSED TO ANY OUTSIDE PARTY, IN WHOLE OR IN PART, WITHOUT WRITTEN PERMISSION OF MINI-CIRCUITS.

SIZE	CODE IDENT	DRAWING NO:	REV:
A	15542	98-PL-126	B
FILE:	98PL126	SCALE: 10:1	SHEET: 1 OF 1

# Characterization Test Board

For Pins Connections refer to Data Sheet of the DUT

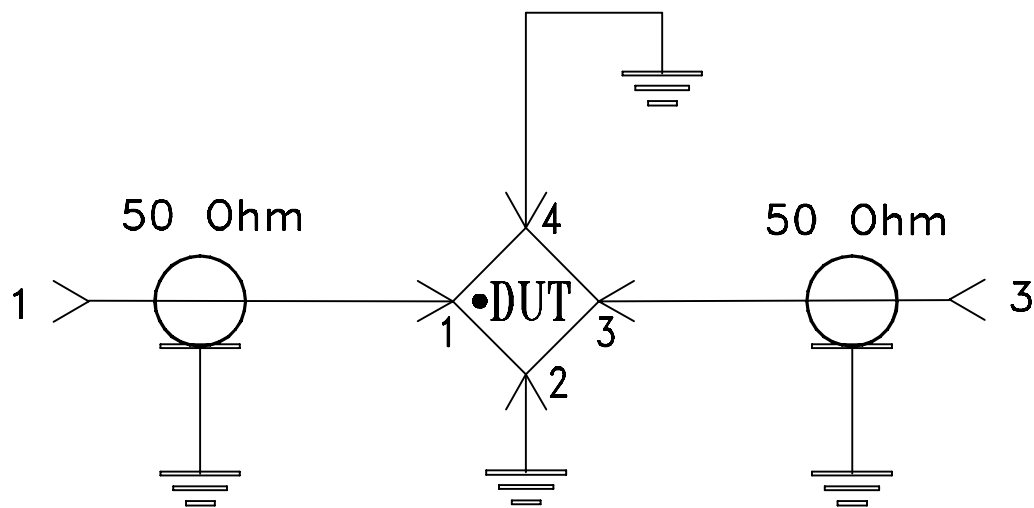
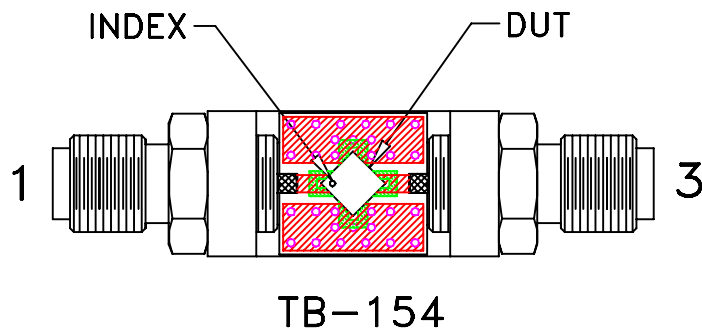

Schematic Diagram

## Notes:

1. SMA Female connectors.
2. PCB Material: Rogers R04350 or equivalent,  
Dielectric Constant=3.5, Thickness=.020 inch.

 Mini-Circuits®

All Mini-Circuits products are manufactured under exacting quality assurance and control standards, and are capable of meeting published specifications after being subjected to any or all of the following physical and environmental test.

Specification	Test/Inspection Condition	Reference/Spec
Operating Temperature	-45° to 85°C or -40° to 85°C Ambient Environment	Individual Model Data Sheet
Storage Temperature	-55° to 100° C Ambient Environment	Individual Model Data Sheet
Thermal Shock	-55° to 100°C, 100 cycles	MIL-STD-202, Method 107, Condition A-3, except +100°C
Mechanical Shock	1.5Kg, 0.5 ms, 5 shock pulses, Y1 direction only	MIL-STD-883, Method 2002, Condition B, except Y1 direction only
Vibration (Variable Frequency)	50g peak	MIL-STD-883, Method 2007, Condition B
Autoclave	15 psig, 100% RH, 121°C, 96 hours	JESD22-A102, Condition C
HAST	130°C, 85% RH, 96 hours	JESD22-A110
Solderability	10X Magnification	J-STD-002, Para 4.2.5, Test S, 95% Coverage
Solder Reflow Heat	Sn-Pb Eutetic Process: 240°C peak Pb-Free Process: 260°C peak	J-STD-020, Table 4-1, 4-2 and 5-2; Figure 5-1
Moisture Sensitivity: Level 1	Bake at 125°C for 24 hours Soak at 85°C/85% RH for 168 hours, Reflow 3 cycles at 260°C peak	J-STD-020
Marking Resistance to Solvents	Isopropyl alcohol + mineral spirits at 25°C; terpene defluxer at 25°C; distilled water + proylene glycol monomethyl ether +	MIL-STD-202, Method 215



All Mini-Circuits products are manufactured under exacting quality assurance and control standards, and are capable of meeting published specifications after being subjected to any or all of the following physical and environmental test.

<b>Specification</b>	<b>Test/Inspection Condition</b>	<b>Reference/Spec</b>
	monoethanolamine at 63°C to 70°C	