

Surface Mount

Monolithic Amplifier

DC-2 GHz

Features

- InGaP HBT microwave amplifier
- Miniature SOT-89 package
- Internally Matched to 50 Ohms
- Frequency range, DC to 2 GHz
- Output power, 15.5 dBm typ.
- Excellent package for heat dissipation, exposed metal bottom
- Low thermal resistance for high reliability
- Aqueous washable
- Protected by US Patent 6,943,629

Applications

- Cellular
- PCS
- Communication receivers & transmitters

General Description

Gali₅₂₊ (RoHS compliant) is a wideband amplifier offering high dynamic range. Lead finish is SnAgNi. It has repeatable performance from lot to lot, and is enclosed in a SOT-89 package. It uses patented Transient Protected Darlington configuration and is fabricated using InGaP HBT technology. Expected MTTF is 14,000 years at 85°C case temperature. Gali₅₂₊ is designed to be rugged for ESD and supply switch-on transients.



Generic photo used for illustration purposes only

Gali₅₂₊

CASE STYLE: DF782

+RoHS Compliant

The +Suffix identifies RoHS Compliance. See our web site for RoHS Compliance methodologies and qualifications

simplified schematic and pin description



Function	Pin Number	Description
RF IN	1	RF input pin. This pin requires the use of an external DC blocking capacitor chosen for the frequency of operation.
RF-OUT and DC-IN	3	RF output and bias pin. DC voltage is present on this pin; therefore a DC blocking capacitor is necessary for proper operation. An RF choke is needed to feed DC bias without loss of RF signal due to the bias connection, as shown in "Recommended Application Circuit".
GND	2,4	Connections to ground. Use via holes as shown in "Suggested Layout for PCB Design" to reduce ground path inductance for best performance.

Notes

- Performance and quality attributes and conditions not expressly stated in this specification document are intended to be excluded and do not form a part of this specification document.
- Electrical specifications and performance data contained in this specification document are based on Mini-Circuit's applicable established test performance criteria and measurement instructions.
- The parts covered by this specification document are subject to Mini-Circuits standard limited warranty and terms and conditions (collectively, "Standard Terms"); Purchasers of this part are entitled to the rights and benefits contained therein. For a full statement of the Standard Terms and the exclusive rights and remedies thereunder, please visit Mini-Circuits' website at www.minicircuits.com/MCLStore/terms.jsp



Electrical Specifications at 25°C and 50mA, unless noted

Parameter		Min.	Typ.	Max.	Units
Frequency Range*		DC		2	GHz
Gain	f=0.1 GHz	—	22.9	—	dB
	f=1 GHz	—	20.8	—	
	f=2 GHz	16	17.8	—	
	f=3 GHz	—	15.9	—	
	f=4 GHz	—	14.4	—	
Input Return Loss	f= DC to 2 GHz		16.5		dB
Output Return Loss	f= DC to 2 GHz		15.5		dB
Output Power @ 1 dB compression	f=1 GHz	13.5	15.5	—	dBm
Output IP3	f=1 GHz		32		dBm
Noise Figure	f=1 GHz		2.7		dB
Recommended Device Operating Current			50		mA
Device Operating Voltage		4.0	4.4	4.8	V
Device Voltage Variation vs. Temperature at 50 mA			-3.2		mV/°C
Device Voltage Variation vs. Current at 25°C			3.5		mV/mA
Thermal Resistance, junction-to-case ¹			85		°C/W

*Guaranteed specification DC-2 GHz. Low frequency cut off determined by external coupling capacitors.

Absolute Maximum Ratings

Parameter	Ratings
Operating Temperature*	-45°C to 85°C
Storage Temperature	-65°C to 150°C
Operating Current	65mA
Input Power	13dBm

Note: Permanent damage may occur if any of these limits are exceeded. These ratings are not intended for continuous normal operation.
¹Case is defined as ground leads.
 *Based on typical case temperature rise 3°C above ambient.

Notes

- A. Performance and quality attributes and conditions not expressly stated in this specification document are intended to be excluded and do not form a part of this specification document.
- B. Electrical specifications and performance data contained in this specification document are based on Mini-Circuit's applicable established test performance criteria and measurement instructions.
- C. The parts covered by this specification document are subject to Mini-Circuits standard limited warranty and terms and conditions (collectively, "Standard Terms"); Purchasers of this part are entitled to the rights and benefits contained therein. For a full statement of the Standard Terms and the exclusive rights and remedies thereunder, please visit Mini-Circuits' website at www.minicircuits.com/MCLStore/terms.jsp



Product Marking

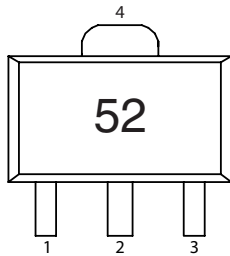

Markings in addition to model number designation may appear for internal quality control purposes.

Additional Detailed Technical Information

Additional information is available on our web site. To access this information enter the model number on our web site home page.

Performance data, graphs, s-parameter data set (.zip file)

Case Style: DF782

Plastic package, exposed paddle, lead finish: Matte-Tin

Tape & Reel: F55

7" reels with 20, 50, 100, 200, 500, 1K devices.

Suggested Layout for PCB Design: PL-019

Evaluation Board: TB-409-52+

Environmental Ratings: ENV08T2

Recommended Application Circuit

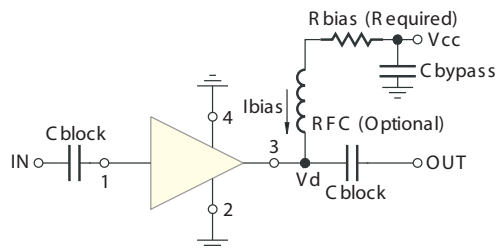

Test Board includes case, connectors, and components (in bold) soldered to PCB

R BIAS	
Vcc	"1%" Res. Values (ohms) for Optimum Biasing
7	51.1
8	69.8
9	88.7
10	110
11	130
12	150
13	169
14	191
15	210
16	232
17	261
18	280
19	301
20	316

Notes

- A. Performance and quality attributes and conditions not expressly stated in this specification document are intended to be excluded and do not form a part of this specification document.
- B. Electrical specifications and performance data contained in this specification document are based on Mini-Circuit's applicable established test performance criteria and measurement instructions.
- C. The parts covered by this specification document are subject to Mini-Circuits standard limited warranty and terms and conditions (collectively, "Standard Terms"); Purchasers of this part are entitled to the rights and benefits contained therein. For a full statement of the Standard Terms and the exclusive rights and remedies thereunder, please visit Mini-Circuits' website at www.minicircuits.com/MCLStore/terms.jsp



ESD Rating

Human Body Model (HBM): Class 1B (500v to < 1000v) in accordance with ANSI/ESD STM 5.1 - 2001

Machine Model (MM): Class M1 (< 100v) in accordance with ANSI/ESD STM 5.2 - 1999

MSL Rating

Moisture Sensitivity: MSL1 in accordance with IPC/JEDECJ-STD-020C

No.	Test Required	Condition	Standard	Quantity
1	Visual Inspection	Low Power Microscope Magnification 40x	MIP-IN-0003 (MCT spec)	45 units
2	Electrical Test	Room Temperature	SCD (MCL spec)	45 units
3	SAM Analysis	Less than 10% growth in term of delamination	J-Std-020C (Jedec Standard)	45 units
4	Moisture Sensitivity Level 1	Bake at 125°C for 24 hours Soak at 85°C/85%RH for 168 hours Reflow 3 cycles at 260°C peak	J-Std-020C (Jedec Standard)	45 units

MSL Test Flow Chart



Notes

- A. Performance and quality attributes and conditions not expressly stated in this specification document are intended to be excluded and do not form a part of this specification document.
- B. Electrical specifications and performance data contained in this specification document are based on Mini-Circuit's applicable established test performance criteria and measurement instructions.
- C. The parts covered by this specification document are subject to Mini-Circuits standard limited warranty and terms and conditions (collectively, "Standard Terms"); Purchasers of this part are entitled to the rights and benefits contained therein. For a full statement of the Standard Terms and the exclusive rights and remedies thereunder, please visit Mini-Circuits' website at www.minicircuits.com/MCLStore/terms.jsp



Typical Performance Data

**NOTE: Use PDF Bookmarks to view DATA at required conditions
or to view GRAPHS.**

Definitions:

Input Return Loss = -S11 (dB)

Gain(Power Gain) = S21 (dB)

Reverse Isolation = -S12 (dB)

Output Return Loss = -S22 (dB)

TEST CONDITIONS: Icc = 50mA, Vd = 4.40V @Temperature = +25degC

FREQ	Gain	Isolation	Input Return Loss	Output Return Loss	Stability		FREQ	IP3 Output	1dB Comp. Output	Noise Figure
(MHz)	(dB)	(dB)	(dB)	(dB)	K	Delta	(MHz)	(dBm)	(dBm)	(dB)
50	22.67	26.03	33.68	18.97	1.07	0.68	50	30.15	15.98	2.79
100	22.63	25.65	31.79	18.92	1.05	0.71	100	30.31	16.16	3.17
200	22.54	25.88	31.39	18.75	1.07	0.68	150	30.57	16.11	2.92
400	22.33	25.78	31.56	18.36	1.07	0.67	200	30.43	16.03	2.78
600	22.02	25.72	31.15	17.87	1.08	0.66	250	29.80	15.99	2.91
800	21.69	25.63	32.46	17.68	1.09	0.64	300	30.49	15.95	3.15
1000	21.30	25.55	32.99	17.49	1.11	0.61	350	30.58	16.20	2.92
1200	20.92	25.50	32.57	17.43	1.13	0.59	400	29.90	16.05	2.89
1400	20.54	25.41	30.47	17.36	1.14	0.57	450	30.15	15.93	2.92
1600	20.13	25.34	28.25	17.45	1.16	0.55	500	29.89	16.01	3.05
1800	19.73	25.26	26.11	17.49	1.19	0.52	550	30.14	15.79	3.06
2000	19.33	25.18	24.08	17.55	1.21	0.50	600	29.93	15.88	2.89
2200	18.94	25.09	22.53	17.73	1.23	0.48	650	30.10	15.96	2.90
2400	18.57	25.01	21.25	17.87	1.25	0.47	700	30.37	15.86	3.02
2600	18.23	24.96	20.00	17.99	1.28	0.45	750	30.08	15.84	3.02
2800	17.90	24.84	19.08	18.11	1.29	0.44	800	30.70	15.93	2.92
3000	17.59	24.80	18.19	18.14	1.31	0.42	850	30.14	15.82	2.88
3200	17.29	24.75	17.45	18.52	1.34	0.41	900	30.88	15.95	3.01
3400	17.04	24.66	16.81	18.61	1.35	0.40	950	30.29	15.88	3.13
3600	16.79	24.61	16.19	18.89	1.37	0.39	1000	30.76	15.91	2.92
3800	16.55	24.57	15.78	19.37	1.39	0.38	1050	30.51	15.90	2.83
4000	16.34	24.56	15.46	19.92	1.42	0.37	1100	30.58	15.55	2.98
4200	16.16	24.50	15.18	20.39	1.43	0.37	1150	30.67	15.68	3.03
4400	16.01	24.52	14.96	21.03	1.45	0.36	1200	30.59	15.24	2.97
4600	15.84	24.47	14.94	21.67	1.47	0.36	1250	30.83	15.48	2.86
4800	15.73	24.44	14.83	22.20	1.48	0.35	1300	30.51	15.30	3.01
5000	15.64	24.44	14.71	22.85	1.49	0.35	1350	30.74	15.35	3.07
5500	15.45	24.44	14.81	23.84	1.52	0.35	1400	30.09	15.23	3.05
6000	15.25	24.42	14.54	21.29	1.55	0.34	1450	30.51	15.48	3.06
6500	14.87	24.45	13.33	17.43	1.59	0.34	1500	30.10	15.26	3.10
7000	14.10	24.21	11.73	13.88	1.62	0.35	1550	30.45	15.43	3.10
7500	12.85	23.83	10.29	11.77	1.70	0.35	1600	30.31	15.36	3.11
8000	11.19	23.21	9.19	10.51	1.81	0.34	1650	30.86	15.51	3.05
9000	7.61	20.92	7.40	8.76	1.88	0.36	1700	31.15	15.35	3.06
10000	4.61	18.01	6.34	8.13	1.75	0.36	1750	31.10	15.41	3.11
11000	2.73	14.67	6.47	8.92	1.51	0.34	1800	31.06	15.27	3.06
12000	1.78	10.99	7.99	11.22	1.29	0.36	1850	30.99	15.43	2.98
13000	0.98	7.11	9.88	14.58	1.11	0.49	1900	30.73	15.32	3.04
14000	-0.54	4.74	7.03	8.85	1.02	0.66	1950	30.97	15.53	3.03
15000	-3.72	5.45	3.72	4.08	1.02	0.73	2000	30.55	15.33	2.94

REV. X1
GALI-52+
120123
Page 1 of 11



IF/RF MICROWAVE COMPONENTS • ISO 9001 ISO 14001 AS 9100 CERTIFIED • RoHS compliant
P.O. Box 350166, Brooklyn, New York 11235-0003 (718) 934-4500 Fax (718) 332-4661



The Design Engineers Search Engine finds the model you need, Instantly • For detailed performance specs & shopping online see



Typical Performance Data

Definitions:

Input Return Loss = -S11 (dB)

Gain(Power Gain) = S21 (dB)

Reverse Isolation = -S12 (dB)

Output Return Loss = -S22 (dB)

TEST CONDITIONS: Icc = 40mA, Vd = 4.36V @Temperature = +25degC

FREQ	Gain	Isolation	Input Return Loss	Output Return Loss	Stability		FREQ	IP3 Output	1dB Comp. Output	Noise Figure
					K	Delta				
(MHz)	(dB)	(dB)	(dB)	(dB)	K	Delta	(MHz)	(dBm)	(dBm)	(dB)
50	22.26	25.77	38.60	22.90	1.08	0.67	50	26.66	13.24	2.73
100	22.27	25.36	40.05	22.66	1.06	0.70	100	26.78	13.42	3.05
200	22.16	25.40	39.86	22.57	1.07	0.69	150	27.01	13.31	2.83
400	21.95	25.40	35.44	21.58	1.07	0.67	200	26.87	13.16	2.80
600	21.68	25.37	33.06	20.46	1.08	0.65	250	26.38	13.19	2.83
800	21.36	25.29	31.25	19.86	1.09	0.63	300	26.91	13.23	3.05
1000	21.01	25.21	29.78	19.33	1.11	0.61	350	26.98	13.39	2.86
1200	20.61	25.12	28.14	19.10	1.12	0.59	400	26.36	13.37	2.86
1400	20.25	25.09	25.95	18.77	1.14	0.57	450	26.60	13.14	2.86
1600	19.86	25.05	24.19	18.69	1.16	0.54	500	26.41	13.36	2.93
1800	19.48	24.96	22.50	18.52	1.18	0.52	550	26.62	13.02	2.99
2000	19.08	24.84	21.31	18.48	1.20	0.51	600	26.44	13.17	2.86
2200	18.72	24.86	20.06	18.47	1.23	0.48	650	26.57	13.30	2.82
2400	18.34	24.75	19.08	18.51	1.24	0.47	700	26.88	13.20	2.92
2600	17.99	24.69	18.31	18.48	1.27	0.45	750	26.56	13.07	2.95
2800	17.69	24.63	17.40	18.49	1.28	0.43	800	27.24	13.28	2.90
3000	17.38	24.56	16.66	18.46	1.30	0.42	850	26.57	13.20	2.83
3200	17.08	24.54	16.18	18.74	1.33	0.41	900	27.33	13.44	2.92
3400	16.83	24.49	15.54	18.74	1.35	0.40	950	26.74	13.28	3.04
3600	16.59	24.43	15.06	18.99	1.36	0.39	1000	27.21	13.32	2.87
3800	16.37	24.40	14.61	19.42	1.38	0.38	1050	26.96	13.25	2.79
4000	16.14	24.42	14.42	19.94	1.41	0.37	1100	27.05	12.91	2.92
4200	15.95	24.41	14.24	20.42	1.43	0.36	1150	27.21	13.22	2.97
4400	15.82	24.37	14.01	21.11	1.45	0.36	1200	27.06	12.57	2.94
4600	15.65	24.34	14.00	21.93	1.47	0.35	1250	27.39	12.86	2.82
4800	15.53	24.34	13.90	22.55	1.48	0.35	1300	27.03	12.70	2.94
5000	15.44	24.33	13.78	23.38	1.49	0.35	1350	27.36	12.87	2.99
5500	15.23	24.38	13.89	25.70	1.54	0.34	1400	26.76	12.67	3.00
6000	15.02	24.35	13.69	23.35	1.56	0.34	1450	27.21	12.93	3.02
6500	14.65	24.33	12.57	18.61	1.59	0.34	1500	26.76	12.64	3.02
7000	13.87	24.13	11.18	14.67	1.64	0.34	1550	27.14	12.98	3.04
7500	12.60	23.76	9.93	12.40	1.73	0.34	1600	26.97	12.66	3.04
8000	10.97	23.11	8.96	11.00	1.83	0.34	1650	27.47	12.93	3.00
9000	7.43	20.89	7.30	9.14	1.91	0.35	1700	27.59	12.67	2.99
10000	4.45	18.03	6.27	8.47	1.78	0.35	1750	27.72	12.93	3.01
11000	2.59	14.72	6.40	9.23	1.53	0.33	1800	27.80	12.77	2.99
12000	1.65	11.07	7.87	11.49	1.31	0.34	1850	27.70	12.82	2.94
13000	0.87	7.17	9.72	14.79	1.12	0.47	1900	27.52	12.80	2.98
14000	-0.62	4.77	6.95	8.92	1.02	0.65	1950	27.74	12.87	2.95
15000	-3.79	5.45	3.70	4.11	1.02	0.72	2000	27.43	12.78	2.88

REV. X1
GALI-52+
120123
Page 2 of 11



IF/RF MICROWAVE COMPONENTS • ISO 9001 ISO 14001 AS 9100 CERTIFIED • RoHS compliant
P.O. Box 350166, Brooklyn, New York 11235-0003 (718) 934-4500 Fax (718) 332-4661



The Design Engineers Search Engine finds the model you need, Instantly • For detailed performance specs & shopping online see



Typical Performance Data

Definitions:

Input Return Loss = -S11 (dB)

Gain(Power Gain) = S21 (dB)

Reverse Isolation = -S12 (dB)

Output Return Loss = -S22 (dB)

TEST CONDITIONS: Icc = 60mA, Vd = 4.43V @Temperature = +25degC

FREQ	Gain	Isolation	Input Return Loss	Output Return Loss	Stability		FREQ	IP3 Output	1dB Comp. Output	Noise Figure
					K	Delta				
(MHz)	(dB)	(dB)	(dB)	(dB)	K	Delta	(MHz)	(dBm)	(dBm)	(dB)
50	22.90	26.34	27.49	17.06	1.07	0.68	50	32.76	17.65	2.85
100	22.86	26.07	26.39	17.15	1.06	0.70	100	32.97	17.72	3.23
200	22.76	26.04	26.53	17.00	1.06	0.69	150	33.18	17.65	2.97
400	22.54	26.02	26.79	16.76	1.07	0.68	200	33.03	17.62	2.83
600	22.22	26.00	26.83	16.51	1.08	0.65	250	32.32	17.63	2.92
800	21.88	25.91	28.02	16.40	1.10	0.63	300	33.11	17.56	3.21
1000	21.50	25.84	29.30	16.37	1.11	0.61	350	33.15	17.77	2.98
1200	21.11	25.73	31.05	16.38	1.13	0.59	400	32.41	17.63	2.91
1400	20.71	25.63	31.49	16.51	1.15	0.57	450	32.64	17.55	2.97
1600	20.29	25.57	30.54	16.59	1.17	0.54	500	32.40	17.58	3.11
1800	19.88	25.44	28.59	16.73	1.19	0.53	550	32.64	17.47	3.13
2000	19.49	25.36	26.09	16.85	1.21	0.50	600	32.37	17.43	2.94
2200	19.10	25.28	24.49	17.12	1.23	0.48	650	32.58	17.46	2.93
2400	18.72	25.17	22.79	17.30	1.26	0.47	700	32.81	17.46	3.10
2600	18.38	25.09	21.48	17.50	1.28	0.45	750	32.59	17.45	3.08
2800	18.04	25.01	20.43	17.65	1.30	0.44	800	33.17	17.43	2.97
3000	17.73	24.91	19.41	17.76	1.32	0.42	850	32.68	17.41	2.91
3200	17.44	24.87	18.53	18.14	1.34	0.41	900	33.31	17.36	3.05
3400	17.17	24.78	17.76	18.29	1.36	0.40	950	32.73	17.38	3.22
3600	16.93	24.74	17.15	18.59	1.38	0.39	1000	33.19	17.42	2.96
3800	16.69	24.69	16.61	19.03	1.40	0.38	1050	32.88	17.36	2.89
4000	16.47	24.64	16.19	19.55	1.41	0.37	1100	33.00	17.27	3.05
4200	16.30	24.60	15.94	20.00	1.43	0.37	1150	32.99	17.27	3.12
4400	16.15	24.57	15.74	20.59	1.45	0.36	1200	33.01	17.10	3.01
4600	15.99	24.53	15.70	21.08	1.46	0.36	1250	33.22	17.11	2.89
4800	15.87	24.50	15.50	21.48	1.47	0.36	1300	32.75	17.15	3.06
5000	15.79	24.49	15.41	21.99	1.48	0.35	1350	32.93	17.13	3.14
5500	15.61	24.50	15.53	22.42	1.52	0.35	1400	32.36	17.05	3.10
6000	15.43	24.44	15.26	20.08	1.53	0.35	1450	32.73	17.09	3.12
6500	15.07	24.47	13.92	16.62	1.56	0.35	1500	32.21	17.01	3.17
7000	14.32	24.24	12.13	13.32	1.59	0.36	1550	32.66	17.16	3.17
7500	13.07	23.87	10.55	11.34	1.67	0.36	1600	32.54	17.03	3.15
8000	11.41	23.23	9.36	10.12	1.77	0.35	1650	33.08	17.08	3.09
9000	7.78	20.93	7.48	8.48	1.84	0.36	1700	33.46	17.09	3.11
10000	4.76	18.00	6.39	7.89	1.72	0.37	1750	33.25	17.02	3.17
11000	2.85	14.62	6.52	8.69	1.48	0.35	1800	33.23	16.98	3.11
12000	1.90	10.93	8.09	11.01	1.27	0.37	1850	32.93	17.08	3.04
13000	1.07	7.07	10.00	14.40	1.10	0.49	1900	32.69	17.03	3.09
14000	-0.48	4.73	7.09	8.77	1.01	0.66	1950	32.74	17.16	3.11
15000	-3.67	5.45	3.74	4.08	1.02	0.73	2000	32.60	17.03	2.99

REV. X1
GALI-52+
120123
Page 3 of 11



IF/RF MICROWAVE COMPONENTS • ISO 9001 ISO 14001 AS 9100 CERTIFIED • RoHS compliant
P.O. Box 350166, Brooklyn, New York 11235-0003 (718) 934-4500 Fax (718) 332-4661



The Design Engineers Search Engine finds the model you need, Instantly • For detailed performance specs & shopping online see



Typical Performance Data

Definitions:

Input Return Loss = -S11 (dB)

Gain(Power Gain) = S21 (dB)

Reverse Isolation = -S12 (dB)

Output Return Loss = -S22 (dB)

TEST CONDITIONS: Icc = 50mA, Vd = 4.63V @Temperature = -45degC

FREQ	Gain	Isolation	Input Return Loss	Output Return Loss	Stability		FREQ	IP3 Output	1dB Comp. Output	Noise Figure
					K	Delta				
(MHz)	(dB)	(dB)	(dB)	(dB)	K	Delta	(MHz)	(dBm)	(dBm)	(dB)
50	22.82	26.04	33.37	18.45	1.06	0.69	50	30.65	16.05	2.41
100	22.79	25.91	34.55	19.19	1.06	0.70	100	30.75	16.08	2.77
200	22.71	25.88	35.75	19.12	1.06	0.70	150	30.93	15.93	2.50
400	22.50	25.87	28.82	17.41	1.07	0.68	200	30.77	15.87	2.37
600	22.20	25.81	29.23	17.36	1.08	0.66	250	30.32	15.90	2.45
800	21.88	25.69	30.62	17.16	1.09	0.65	300	30.94	15.94	2.69
1000	21.51	25.66	31.17	17.20	1.10	0.62	350	31.10	16.20	2.49
1200	21.14	25.56	32.85	16.77	1.12	0.60	400	30.50	16.05	2.44
1400	20.77	25.48	32.19	16.66	1.13	0.58	450	30.79	15.95	2.45
1600	20.36	25.40	30.53	16.84	1.15	0.56	500	30.56	16.07	2.60
1800	19.97	25.29	28.51	17.14	1.17	0.54	550	30.81	15.78	2.60
2000	19.60	25.15	25.57	17.22	1.19	0.52	600	30.57	15.97	2.42
2200	19.21	25.17	24.03	17.17	1.22	0.50	650	30.79	15.92	2.42
2400	18.84	25.05	22.63	17.20	1.23	0.48	700	31.07	15.95	2.54
2600	18.51	24.94	21.35	17.29	1.25	0.47	750	30.77	15.81	2.55
2800	18.18	24.89	20.25	17.62	1.27	0.45	800	31.41	15.90	2.46
3000	17.88	24.76	19.37	17.63	1.29	0.44	850	30.80	15.88	2.43
3200	17.61	24.70	18.72	18.01	1.30	0.43	900	31.59	16.05	2.53
3400	17.35	24.59	18.15	18.03	1.32	0.42	950	30.99	15.87	2.57
3600	17.12	24.57	17.47	18.27	1.34	0.41	1000	31.51	15.95	2.45
3800	16.89	24.52	17.01	18.58	1.35	0.40	1050	31.21	15.94	2.38
4000	16.69	24.49	16.70	18.81	1.37	0.39	1100	31.33	15.55	2.49
4200	16.53	24.41	16.87	18.82	1.38	0.39	1150	31.41	15.73	2.55
4400	16.39	24.41	16.57	19.23	1.40	0.38	1200	31.34	15.28	2.48
4600	16.23	24.38	16.38	19.65	1.42	0.38	1250	31.69	15.47	2.37
4800	16.13	24.34	16.04	20.40	1.42	0.37	1300	31.25	15.31	2.53
5000	16.06	24.33	15.97	21.29	1.43	0.37	1350	31.60	15.41	2.58
5500	15.95	24.30	15.66	22.80	1.45	0.37	1400	30.99	15.32	2.54
6000	15.84	24.22	15.55	19.58	1.44	0.38	1450	31.39	15.48	2.57
6500	15.63	24.19	14.45	15.88	1.45	0.38	1500	30.93	15.31	2.59
7000	15.03	23.95	12.64	12.65	1.46	0.39	1550	31.33	15.50	2.60
7500	13.86	23.66	10.39	10.71	1.51	0.39	1600	31.19	15.34	2.59
8000	12.32	23.03	9.13	9.88	1.59	0.39	1650	31.74	15.51	2.53
9000	8.72	20.80	7.44	8.03	1.66	0.40	1700	31.87	15.32	2.54
10000	5.50	18.10	6.03	7.19	1.56	0.41	1750	32.04	15.46	2.59
11000	3.58	14.67	6.21	8.09	1.35	0.38	1800	31.90	15.29	2.53
12000	2.71	10.88	8.02	10.51	1.18	0.40	1850	31.91	15.47	2.47
13000	1.64	7.18	8.74	12.31	1.03	0.53	1900	31.64	15.40	2.51
14000	0.38	4.37	7.73	9.62	0.96	0.70	1950	32.06	15.61	2.52
15000	-3.03	5.07	3.42	3.59	0.96	0.81	2000	31.54	15.39	2.43

REV. X1

GALI-52+

120123

Page 4 of 11



IF/RF MICROWAVE COMPONENTS • ISO 9001 ISO 14001 AS 9100 CERTIFIED • RoHS compliant

P.O. Box 350166, Brooklyn, New York 11235-0003 (718) 934-4500 Fax (718) 332-4661



The Design Engineers Search Engine finds the model you need, Instantly • For detailed performance specs & shopping online see



Typical Performance Data

Definitions:

Input Return Loss = -S11 (dB)

Gain(Power Gain) = S21 (dB)

Reverse Isolation = -S12 (dB)

Output Return Loss = -S22 (dB)

TEST CONDITIONS: Icc = 40mA, Vd = 4.59V @Temperature = -45degC

FREQ	Gain	Isolation	Input Return Loss	Output Return Loss	Stability		FREQ	IP3 Output	1dB Comp. Output	Noise Figure
					K	Delta				
(MHz)	(dB)	(dB)	(dB)	(dB)	K	Delta	(MHz)	(dBm)	(dBm)	(dB)
50	22.48	25.47	40.91	21.62	1.05	0.71	50	27.02	13.27	2.38
100	22.49	25.57	38.40	22.70	1.06	0.70	100	27.12	13.37	2.64
200	22.38	25.56	35.80	22.60	1.06	0.69	150	27.24	13.14	2.45
400	22.16	25.52	35.55	19.83	1.07	0.68	200	27.11	13.09	2.38
600	21.91	25.46	34.17	19.47	1.08	0.66	250	26.75	13.20	2.41
800	21.60	25.40	33.44	18.99	1.09	0.64	300	27.26	13.23	2.62
1000	21.26	25.33	30.87	18.91	1.10	0.62	350	27.43	13.49	2.45
1200	20.87	25.28	30.95	18.23	1.12	0.60	400	26.87	13.38	2.43
1400	20.52	25.19	29.14	17.81	1.13	0.58	450	27.16	13.23	2.45
1600	20.12	25.09	26.92	17.93	1.15	0.56	500	26.95	13.35	2.52
1800	19.75	25.01	24.73	18.14	1.16	0.54	550	27.20	13.17	2.55
2000	19.38	24.95	22.81	18.22	1.19	0.52	600	27.00	13.22	2.42
2200	19.01	24.88	21.62	18.00	1.20	0.50	650	27.16	13.20	2.41
2400	18.64	24.81	20.51	17.99	1.23	0.48	700	27.47	13.23	2.47
2600	18.30	24.75	19.51	17.89	1.25	0.46	750	27.14	13.13	2.50
2800	18.00	24.65	18.68	18.09	1.26	0.45	800	27.79	13.24	2.45
3000	17.70	24.61	17.76	18.01	1.28	0.43	850	27.12	13.06	2.39
3200	17.42	24.55	17.37	18.31	1.30	0.42	900	27.91	13.35	2.45
3400	17.17	24.46	16.89	18.31	1.32	0.41	950	27.30	13.14	2.52
3600	16.95	24.43	16.25	18.51	1.33	0.40	1000	27.83	13.21	2.41
3800	16.73	24.39	15.88	18.84	1.35	0.40	1050	27.56	13.22	2.35
4000	16.52	24.37	15.72	19.09	1.37	0.39	1100	27.67	12.90	2.43
4200	16.34	24.33	15.79	19.13	1.39	0.38	1150	27.81	13.18	2.48
4400	16.22	24.33	15.58	19.54	1.40	0.38	1200	27.64	12.66	2.46
4600	16.06	24.24	15.35	20.09	1.41	0.37	1250	27.97	12.93	2.34
4800	15.96	24.24	15.06	20.90	1.42	0.37	1300	27.65	12.74	2.47
5000	15.89	24.21	15.02	21.99	1.43	0.37	1350	28.01	12.81	2.52
5500	15.75	24.25	14.73	24.47	1.46	0.37	1400	27.42	12.68	2.51
6000	15.64	24.15	14.59	21.03	1.46	0.37	1450	27.86	12.86	2.53
6500	15.43	24.11	13.62	16.86	1.46	0.38	1500	27.40	12.71	2.55
7000	14.82	23.87	12.07	13.33	1.47	0.39	1550	27.85	12.98	2.54
7500	13.65	23.56	10.03	11.27	1.53	0.39	1600	27.63	12.61	2.55
8000	12.09	22.95	8.89	10.39	1.61	0.38	1650	28.11	12.92	2.52
9000	8.54	20.78	7.33	8.38	1.68	0.39	1700	28.18	12.75	2.51
10000	5.35	18.11	5.97	7.49	1.59	0.40	1750	28.32	12.90	2.54
11000	3.45	14.72	6.15	8.39	1.37	0.37	1800	28.20	12.77	2.49
12000	2.59	10.95	7.89	10.78	1.19	0.39	1850	28.37	12.82	2.42
13000	1.54	7.23	8.62	12.53	1.04	0.52	1900	28.07	12.73	2.48
14000	0.30	4.40	7.65	9.71	0.96	0.69	1950	28.55	12.86	2.45
15000	-3.10	5.08	3.40	3.62	0.96	0.80	2000	27.99	12.77	2.38

REV. X1

GALI-52+

120123

Page 5 of 11



IF/RF MICROWAVE COMPONENTS • ISO 9001 ISO 14001 AS 9100 CERTIFIED • RoHS compliant

P.O. Box 350166, Brooklyn, New York 11235-0003 (718) 934-4500 Fax (718) 332-4661



The Design Engineers Search Engine finds the model you need, Instantly • For detailed performance specs & shopping online see



Typical Performance Data

Definitions:

Input Return Loss = -S11 (dB)

Gain(Power Gain) = S21 (dB)

Reverse Isolation = -S12 (dB)

Output Return Loss = -S22 (dB)

TEST CONDITIONS: Icc = 60mA, Vd = 4.66V @Temperature = -45degC

FREQ	Gain	Isolation	Input Return Loss	Output Return Loss	Stability		FREQ	IP3 Output	1dB Comp. Output	Noise Figure
					K	Delta				
(MHz)	(dB)	(dB)	(dB)	(dB)	K	Delta	(MHz)	(dBm)	(dBm)	(dB)
50	23.02	26.37	28.31	17.03	1.07	0.69	50	33.45	17.84	2.46
100	22.99	26.06	28.21	17.49	1.05	0.71	100	33.51	17.91	2.82
200	22.90	26.14	29.07	17.66	1.06	0.69	150	33.72	17.86	2.55
400	22.68	26.10	25.67	16.25	1.07	0.68	200	33.57	17.80	2.40
600	22.38	26.05	26.05	16.13	1.08	0.66	250	32.94	17.82	2.48
800	22.06	25.96	27.18	16.04	1.09	0.64	300	33.76	17.80	2.74
1000	21.68	25.82	28.02	16.09	1.10	0.63	350	33.87	18.02	2.53
1200	21.30	25.79	29.81	15.94	1.12	0.60	400	33.25	17.89	2.46
1400	20.91	25.68	30.30	15.85	1.13	0.58	450	33.53	17.84	2.50
1600	20.51	25.57	30.97	16.13	1.15	0.56	500	33.25	17.84	2.64
1800	20.11	25.47	30.55	16.42	1.17	0.54	550	33.51	17.66	2.65
2000	19.74	25.33	27.38	16.59	1.19	0.52	600	33.31	17.72	2.46
2200	19.34	25.27	25.95	16.52	1.21	0.50	650	33.47	17.68	2.46
2400	18.97	25.14	24.25	16.67	1.23	0.49	700	33.78	17.75	2.60
2600	18.64	25.11	22.76	16.87	1.25	0.47	750	33.59	17.65	2.59
2800	18.32	24.98	21.60	17.15	1.27	0.45	800	34.13	17.70	2.47
3000	18.00	24.90	20.54	17.22	1.29	0.44	850	33.59	17.67	2.43
3200	17.73	24.85	19.81	17.65	1.31	0.43	900	34.37	17.63	2.57
3400	17.48	24.74	19.17	17.69	1.32	0.42	950	33.72	17.66	2.63
3600	17.24	24.67	18.39	17.93	1.34	0.41	1000	34.25	17.69	2.45
3800	17.02	24.60	17.94	18.20	1.35	0.40	1050	33.90	17.69	2.41
4000	16.82	24.55	17.59	18.45	1.37	0.39	1100	34.10	17.45	2.54
4200	16.65	24.53	17.64	18.46	1.39	0.39	1150	34.13	17.54	2.60
4400	16.51	24.49	17.40	18.80	1.40	0.38	1200	33.97	17.26	2.53
4600	16.36	24.42	17.24	19.14	1.41	0.38	1250	34.27	17.41	2.40
4800	16.26	24.39	16.83	19.87	1.42	0.38	1300	33.98	17.38	2.57
5000	16.20	24.36	16.71	20.53	1.42	0.38	1350	34.20	17.42	2.62
5500	16.09	24.34	16.39	21.64	1.44	0.38	1400	33.53	17.29	2.59
6000	16.00	24.25	16.19	18.73	1.43	0.38	1450	33.95	17.38	2.60
6500	15.82	24.20	15.22	15.21	1.43	0.39	1500	33.47	17.26	2.64
7000	15.24	23.99	13.06	12.15	1.44	0.40	1550	33.89	17.41	2.66
7500	14.08	23.67	10.78	10.26	1.49	0.40	1600	33.80	17.26	2.63
8000	12.54	23.06	9.29	9.50	1.56	0.40	1650	34.33	17.36	2.56
9000	8.91	20.83	7.53	7.75	1.63	0.41	1700	34.64	17.31	2.58
10000	5.65	18.08	6.08	6.96	1.53	0.42	1750	34.64	17.27	2.64
11000	3.71	14.63	6.27	7.85	1.33	0.39	1800	34.59	17.20	2.57
12000	2.82	10.83	8.13	10.29	1.16	0.42	1850	34.37	17.34	2.50
13000	1.74	7.12	8.85	12.16	1.02	0.54	1900	34.24	17.26	2.55
14000	0.45	4.36	7.81	9.56	0.96	0.71	1950	34.35	17.45	2.57
15000	-2.97	5.05	3.45	3.57	0.96	0.81	2000	34.10	17.28	2.48

REV. X1

GALI-52+

120123

Page 6 of 11



IF/RF MICROWAVE COMPONENTS • ISO 9001 ISO 14001 AS 9100 CERTIFIED • RoHS compliant

P.O. Box 350166, Brooklyn, New York 11235-0003 (718) 934-4500 Fax (718) 332-4661



The Design Engineers Search Engine finds the model you need, Instantly • For detailed performance specs & shopping online see



Typical Performance Data

Definitions:

Input Return Loss = -S11 (dB)

Gain(Power Gain) = S21 (dB)

Reverse Isolation = -S12 (dB)

Output Return Loss = -S22 (dB)

TEST CONDITIONS: Icc = 50mA, Vd = 4.21V @Temperature = +85degC

FREQ	Gain	Isolation	Input Return Loss	Output Return Loss	Stability		FREQ	IP3 Output	1dB Comp. Output	Noise Figure
					K	Delta				
(MHz)	(dB)	(dB)	(dB)	(dB)	K	Delta	(MHz)	(dBm)	(dBm)	(dB)
50	22.47	25.69	36.32	19.88	1.06	0.69	50	29.87	15.98	3.19
100	22.45	25.61	32.41	19.42	1.06	0.70	100	30.00	16.07	3.49
200	22.36	25.65	30.09	18.44	1.07	0.69	150	30.36	15.96	3.30
400	22.11	25.59	33.24	19.15	1.07	0.67	200	30.19	15.91	3.17
600	21.82	25.58	33.81	18.74	1.09	0.65	250	29.50	15.93	3.29
800	21.47	25.54	34.63	18.75	1.10	0.63	300	30.22	15.95	3.48
1000	21.10	25.42	33.50	18.68	1.11	0.61	350	30.19	16.09	3.34
1200	20.69	25.34	31.14	18.55	1.13	0.58	400	29.45	15.92	3.31
1400	20.30	25.28	28.39	18.38	1.15	0.56	450	29.68	15.83	3.33
1600	19.89	25.20	26.28	18.22	1.17	0.54	500	29.42	15.91	3.46
1800	19.49	25.13	24.11	18.06	1.19	0.52	550	29.65	15.67	3.50
2000	19.09	25.03	22.42	17.95	1.21	0.50	600	29.40	15.68	3.30
2200	18.68	24.97	21.04	18.09	1.24	0.47	650	29.57	15.73	3.32
2400	18.30	24.87	19.93	18.12	1.26	0.46	700	29.81	15.74	3.45
2600	17.93	24.78	19.01	18.17	1.28	0.44	750	29.52	15.72	3.45
2800	17.58	24.74	18.21	18.31	1.31	0.42	800	30.14	15.74	3.36
3000	17.27	24.68	17.32	18.33	1.33	0.41	850	29.56	15.73	3.32
3200	16.96	24.61	16.61	18.77	1.35	0.40	900	30.18	15.84	3.44
3400	16.68	24.56	15.95	19.01	1.38	0.39	950	29.66	15.72	3.52
3600	16.42	24.51	15.23	19.55	1.40	0.38	1000	30.02	15.73	3.36
3800	16.17	24.48	14.76	20.22	1.42	0.37	1050	29.78	15.75	3.28
4000	15.95	24.45	14.44	20.98	1.44	0.36	1100	29.87	15.47	3.42
4200	15.75	24.45	14.25	21.75	1.47	0.35	1150	29.99	15.61	3.51
4400	15.57	24.44	14.12	22.49	1.49	0.35	1200	29.87	15.10	3.43
4600	15.41	24.40	14.08	23.05	1.51	0.34	1250	30.11	15.35	3.31
4800	15.28	24.37	14.13	23.15	1.52	0.34	1300	29.79	15.12	3.48
5000	15.15	24.39	14.19	23.36	1.55	0.33	1350	29.99	15.28	3.53
5500	14.88	24.40	14.37	23.36	1.59	0.32	1400	29.44	15.21	3.51
6000	14.58	24.38	14.09	21.67	1.63	0.32	1450	29.78	15.31	3.54
6500	14.09	24.35	12.95	18.37	1.69	0.32	1500	29.36	15.19	3.59
7000	13.18	24.16	11.52	14.73	1.76	0.32	1550	29.73	15.39	3.57
7500	11.87	23.79	10.54	12.45	1.88	0.31	1600	29.66	15.18	3.56
8000	10.22	23.08	9.48	11.07	1.99	0.31	1650	30.14	15.41	3.51
9000	6.68	20.88	7.36	9.07	2.05	0.33	1700	30.41	15.22	3.52
10000	3.90	17.94	6.60	8.68	1.89	0.32	1750	30.36	15.30	3.56
11000	2.14	14.63	6.88	9.45	1.63	0.30	1800	30.33	15.18	3.53
12000	1.03	11.16	8.02	10.90	1.38	0.32	1850	30.15	15.34	3.46
13000	0.37	7.23	10.71	14.88	1.18	0.43	1900	29.88	15.31	3.51
14000	-0.95	4.80	7.39	9.38	1.06	0.62	1950	30.02	15.40	3.51
15000	-4.19	5.74	3.77	4.25	1.06	0.69	2000	29.69	15.28	3.41

REV. X1
GALI-52+
120123
Page 7 of 11



IF/RF MICROWAVE COMPONENTS • ISO 9001 ISO 14001 AS 9100 CERTIFIED • RoHS compliant
P.O. Box 350166, Brooklyn, New York 11235-0003 (718) 934-4500 Fax (718) 332-4661



The Design Engineers Search Engine finds the model you need, Instantly • For detailed performance specs & shopping online see



Typical Performance Data

Definitions:

Input Return Loss = -S11 (dB)

Gain(Power Gain) = S21 (dB)

Reverse Isolation = -S12 (dB)

Output Return Loss = -S22 (dB)

TEST CONDITIONS: Icc = 40mA, Vd = 4.17V @Temperature = +85degC

FREQ	Gain	Isolation	Input Return Loss	Output Return Loss	Stability		FREQ	IP3 Output	1dB Comp. Output	Noise Figure
					K	Delta				
(MHz)	(dB)	(dB)	(dB)	(dB)	K	Delta	(MHz)	(dBm)	(dBm)	(dB)
50	22.03	25.25	33.40	25.00	1.07	0.69	50	26.66	13.42	3.14
100	22.05	25.12	35.84	23.83	1.06	0.70	100	26.83	13.47	3.41
200	21.93	25.27	40.61	22.79	1.07	0.68	150	27.14	13.44	3.27
400	21.70	25.20	31.96	23.03	1.08	0.67	200	26.94	13.36	3.16
600	21.45	25.14	29.76	21.84	1.08	0.65	250	26.37	13.48	3.24
800	21.12	25.13	27.73	21.25	1.10	0.63	300	26.95	13.43	3.41
1000	20.76	25.04	26.16	20.70	1.11	0.61	350	26.97	13.66	3.27
1200	20.36	24.99	25.16	20.30	1.13	0.58	400	26.29	13.37	3.30
1400	20.00	24.93	23.64	19.83	1.15	0.56	450	26.50	13.37	3.31
1600	19.60	24.85	22.43	19.53	1.17	0.54	500	26.28	13.42	3.38
1800	19.21	24.77	21.01	19.18	1.18	0.52	550	26.46	13.05	3.44
2000	18.81	24.69	19.94	18.92	1.20	0.50	600	26.28	13.27	3.27
2200	18.43	24.68	18.75	18.82	1.23	0.47	650	26.40	13.32	3.30
2400	18.04	24.56	17.98	18.73	1.25	0.46	700	26.69	13.28	3.38
2600	17.68	24.57	17.32	18.60	1.28	0.44	750	26.36	13.19	3.40
2800	17.37	24.49	16.51	18.58	1.30	0.42	800	27.01	13.28	3.33
3000	17.05	24.41	15.88	18.55	1.32	0.41	850	26.37	13.27	3.30
3200	16.74	24.40	15.35	18.86	1.35	0.39	900	27.10	13.45	3.38
3400	16.47	24.37	14.72	18.97	1.37	0.38	950	26.52	13.30	3.45
3600	16.21	24.35	14.15	19.44	1.39	0.37	1000	26.95	13.26	3.33
3800	15.97	24.30	13.70	20.05	1.41	0.36	1050	26.72	13.25	3.25
4000	15.73	24.28	13.49	20.72	1.44	0.36	1100	26.79	12.94	3.35
4200	15.53	24.28	13.35	21.47	1.46	0.35	1150	26.96	13.20	3.44
4400	15.38	24.30	13.20	22.31	1.49	0.34	1200	26.78	12.52	3.40
4600	15.20	24.24	13.23	23.15	1.50	0.34	1250	27.12	12.94	3.27
4800	15.06	24.23	13.27	23.50	1.52	0.33	1300	26.74	12.72	3.40
5000	14.96	24.27	13.25	23.95	1.54	0.33	1350	27.07	12.84	3.47
5500	14.67	24.28	13.47	25.04	1.59	0.32	1400	26.47	12.68	3.46
6000	14.36	24.33	13.28	23.96	1.65	0.31	1450	26.88	12.98	3.52
6500	13.85	24.29	12.27	19.78	1.70	0.31	1500	26.47	12.72	3.52
7000	12.95	24.04	11.03	15.61	1.77	0.31	1550	26.87	12.95	3.51
7500	11.65	23.65	10.20	13.12	1.89	0.31	1600	26.75	12.71	3.53
8000	10.00	22.97	9.28	11.60	2.01	0.30	1650	27.29	12.90	3.49
9000	6.52	20.83	7.27	9.47	2.08	0.32	1700	27.41	12.80	3.48
10000	3.76	17.95	6.55	9.06	1.92	0.31	1750	27.51	12.96	3.49
11000	2.01	14.68	6.80	9.78	1.65	0.29	1800	27.37	12.77	3.47
12000	0.91	11.25	7.93	11.15	1.41	0.31	1850	27.46	12.89	3.45
13000	0.27	7.30	10.56	14.98	1.19	0.42	1900	27.14	12.84	3.48
14000	-1.04	4.82	7.33	9.47	1.06	0.62	1950	27.53	12.89	3.43
15000	-4.25	5.75	3.76	4.28	1.07	0.68	2000	26.94	12.89	3.35

REV. X1
GALI-52+
120123
Page 8 of 11



IF/RF MICROWAVE COMPONENTS • ISO 9001 ISO 14001 AS 9100 CERTIFIED • RoHS compliant
P.O. Box 350166, Brooklyn, New York 11235-0003 (718) 934-4500 Fax (718) 332-4661



The Design Engineers Search Engine finds the model you need, Instantly • For detailed performance specs & shopping online see



Typical Performance Data

Definitions:

Input Return Loss = -S11 (dB)

Gain(Power Gain) = S21 (dB)

Reverse Isolation = -S12 (dB)

Output Return Loss = -S22 (dB)

TEST CONDITIONS: Icc = 60mA, Vd = 4.24V @Temperature = +85degC

FREQ	Gain	Isolation	Input Return Loss	Output Return Loss	Stability		FREQ	IP3 Output	1dB Comp. Output	Noise Figure
					K	Delta				
(MHz)	(dB)	(dB)	(dB)	(dB)	K	Delta	(MHz)	(dBm)	(dBm)	(dB)
50	22.75	25.94	27.88	17.53	1.06	0.70	50	32.35	17.43	3.26
100	22.70	26.12	26.35	17.38	1.07	0.68	100	32.57	17.44	3.56
200	22.59	25.98	25.14	16.80	1.07	0.68	150	33.00	17.41	3.38
400	22.36	25.95	27.60	17.25	1.08	0.67	200	32.75	17.42	3.21
600	22.03	25.84	28.75	17.22	1.09	0.65	250	31.91	17.38	3.34
800	21.69	25.79	30.74	17.20	1.10	0.63	300	32.80	17.32	3.55
1000	21.31	25.70	33.44	17.38	1.12	0.60	350	32.73	17.50	3.40
1200	20.91	25.59	34.23	17.34	1.13	0.58	400	32.02	17.40	3.33
1400	20.49	25.51	31.78	17.32	1.15	0.56	450	32.14	17.22	3.36
1600	20.07	25.46	29.19	17.26	1.18	0.54	500	31.85	17.32	3.53
1800	19.64	25.31	26.53	17.30	1.20	0.52	550	32.07	17.17	3.54
2000	19.25	25.23	24.39	17.30	1.22	0.50	600	31.80	17.16	3.34
2200	18.84	25.14	22.82	17.46	1.24	0.48	650	31.99	17.15	3.36
2400	18.45	25.04	21.42	17.63	1.27	0.46	700	32.09	17.15	3.53
2600	18.09	24.96	20.37	17.70	1.29	0.44	750	31.94	17.14	3.53
2800	17.74	24.88	19.41	17.86	1.31	0.43	800	32.44	17.14	3.40
3000	17.41	24.78	18.39	18.01	1.33	0.41	850	31.90	17.12	3.35
3200	17.11	24.76	17.59	18.46	1.36	0.40	900	32.48	17.00	3.52
3400	16.82	24.66	16.82	18.75	1.38	0.39	950	31.91	17.10	3.58
3600	16.56	24.58	16.06	19.31	1.39	0.38	1000	32.24	17.11	3.39
3800	16.30	24.57	15.51	20.03	1.42	0.37	1050	31.92	17.04	3.33
4000	16.09	24.56	15.16	20.77	1.45	0.36	1100	32.11	16.97	3.50
4200	15.89	24.50	14.92	21.46	1.47	0.36	1150	32.04	16.95	3.58
4400	15.72	24.50	14.79	22.10	1.49	0.35	1200	31.99	16.78	3.47
4600	15.56	24.48	14.76	22.49	1.51	0.34	1250	32.14	16.79	3.34
4800	15.42	24.45	14.77	22.49	1.52	0.34	1300	31.75	16.89	3.54
5000	15.30	24.45	14.82	22.45	1.54	0.34	1350	31.83	16.81	3.59
5500	15.03	24.46	15.02	22.07	1.58	0.33	1400	31.34	16.78	3.57
6000	14.75	24.44	14.71	20.38	1.62	0.32	1450	31.60	16.81	3.58
6500	14.27	24.43	13.44	17.51	1.67	0.32	1500	31.20	16.74	3.62
7000	13.38	24.20	11.85	14.17	1.74	0.32	1550	31.53	16.78	3.65
7500	12.05	23.82	10.76	12.02	1.85	0.32	1600	31.54	16.78	3.62
8000	10.40	23.14	9.63	10.71	1.96	0.32	1650	32.11	16.76	3.54
9000	6.82	20.91	7.42	8.80	2.02	0.33	1700	32.25	16.72	3.60
10000	4.01	17.93	6.64	8.43	1.86	0.33	1750	31.99	16.68	3.65
11000	2.24	14.58	6.92	9.22	1.60	0.31	1800	31.95	16.67	3.61
12000	1.12	11.10	8.10	10.70	1.37	0.33	1850	31.59	16.71	3.51
13000	0.46	7.17	10.83	14.75	1.17	0.44	1900	31.43	16.70	3.59
14000	-0.89	4.77	7.45	9.31	1.06	0.63	1950	31.35	16.75	3.59
15000	-4.14	5.73	3.79	4.24	1.06	0.69	2000	31.26	16.62	3.48

REV. X1
GALI-52+
120123
Page 9 of 11



IF/RF MICROWAVE COMPONENTS • ISO 9001 ISO 14001 AS 9100 CERTIFIED • RoHS compliant
P.O. Box 350166, Brooklyn, New York 11235-0003 (718) 934-4500 Fax (718) 332-4661



The Design Engineers Search Engine finds the model you need, Instantly • For detailed performance specs & shopping online see



Typical Performance Curves

GAIN vs. TEMPERATURE

INPUT POWER = -25dBm, CURRENT = 50mA

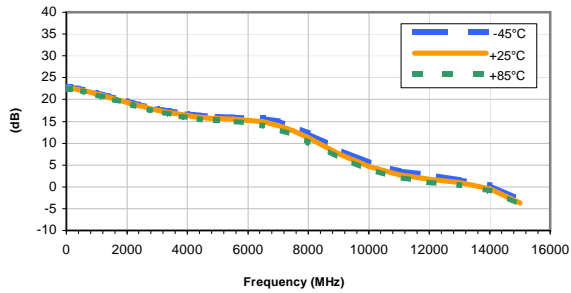

GAIN vs. CURRENT

INPUT POWER = -25dBm, Temperature = +25°C

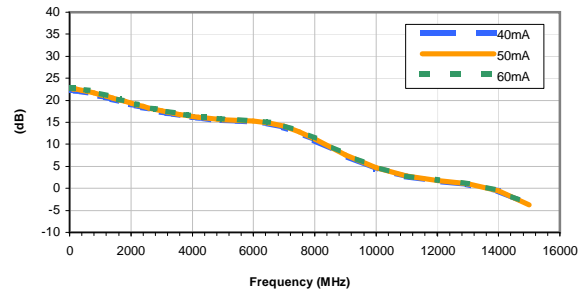

ISOLATION vs. TEMPERATURE

INPUT POWER = -25dBm, CURRENT = 50mA

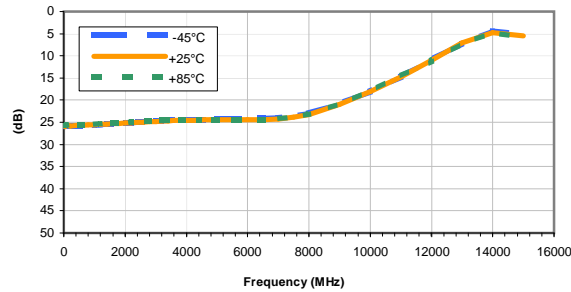

ISOLATION vs. CURRENT

INPUT POWER = -25dBm, Temperature = +25°C

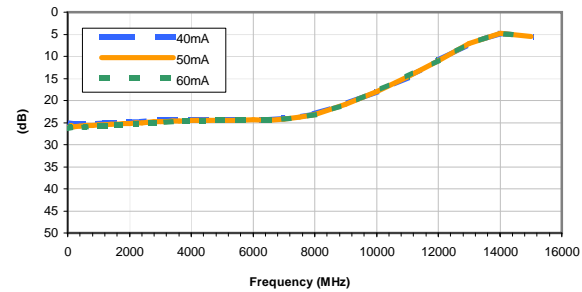

INPUT RETURN LOSS vs. TEMPERATURE

INPUT POWER = -25dBm, CURRENT = 50mA

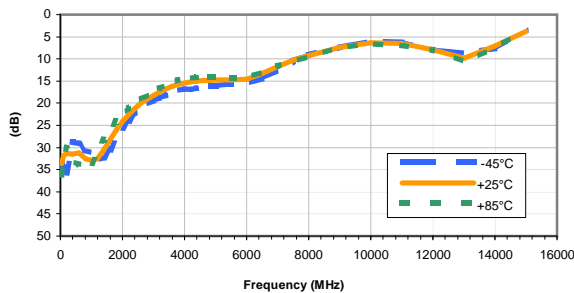

INPUT RETURN LOSS vs. CURRENT

INPUT POWER = -25dBm, Temperature = +25°C

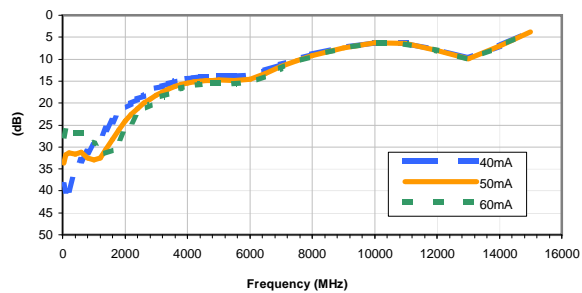

OUTPUT RETURN LOSS vs. TEMPERATURE

INPUT POWER = -25dBm, CURRENT = 50mA

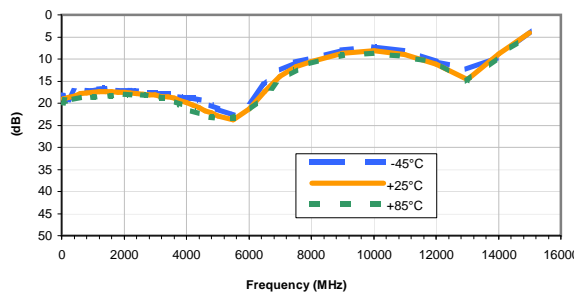

OUTPUT RETURN LOSS vs. CURRENT

INPUT POWER = -25dBm, Temperature = +25°C

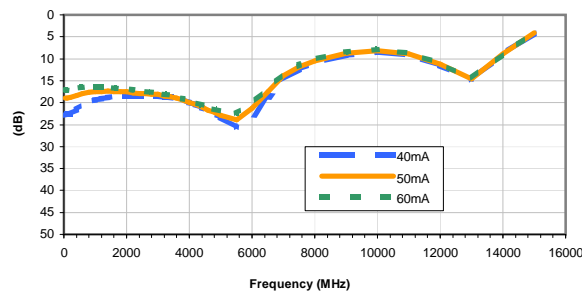

IF/RF MICROWAVE COMPONENTS • ISO 9001 ISO 14001 AS 9100 CERTIFIED • RoHS compliant
 P.O. Box 350166, Brooklyn, New York 11235-0003 (718) 934-4500 Fax (718) 332-4661



The Design Engineers Search Engine finds the model you need, Instantly • For detailed performance specs & shopping online see



Typical Performance Curves

OUTPUT IP3 vs. TEMPERATURE

INPUT POWER = -25dBm, CURRENT = 50mA

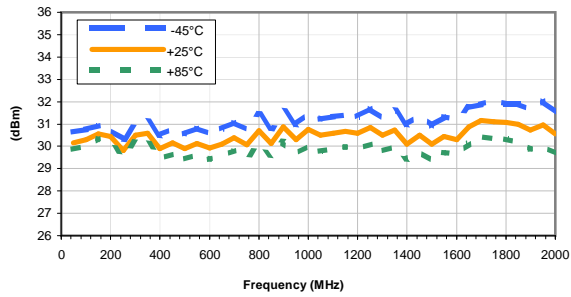

OUTPUT IP3 vs. CURRENT

INPUT POWER = -25dBm, Temperature = +25°C

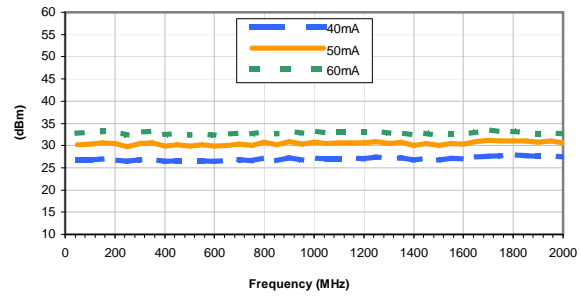

OUTPUT POWER at 1dB Compression vs. TEMPERATURE

CURRENT = 50mA

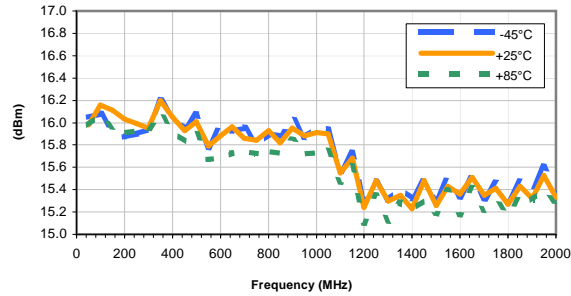

OUTPUT POWER at 1dB Compression vs. CURRENT

Temperature = +25°C

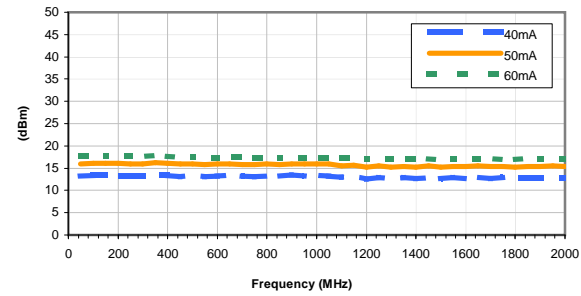

Noise Figure vs. TEMPERATURE

CURRENT = 50mA

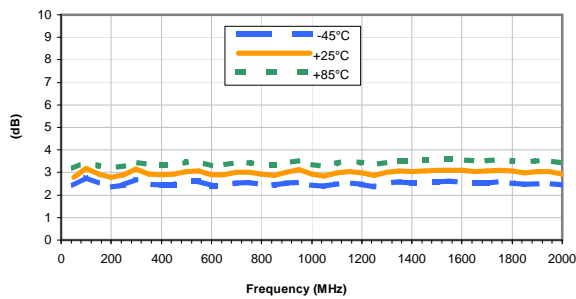

Noise Figure vs. CURRENT

Temperature = +25°C

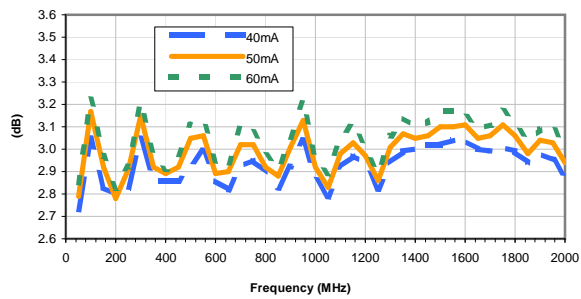

Typical Performance Curves

GAIN vs. TEMPERATURE

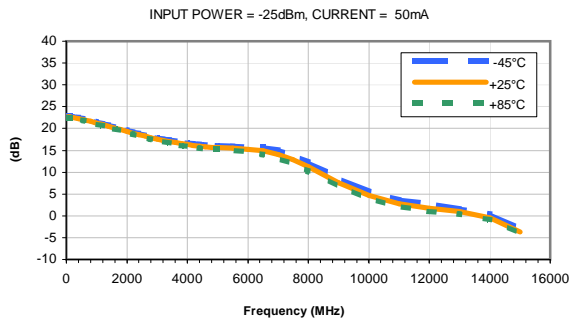

GAIN vs. CURRENT

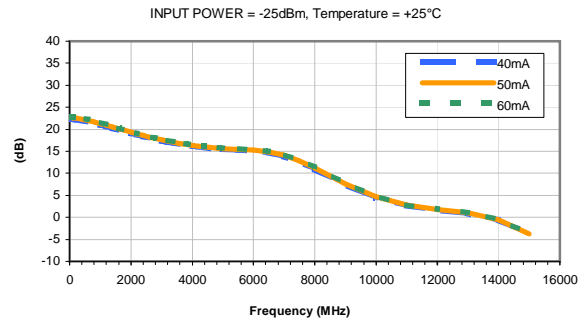

ISOLATION vs. TEMPERATURE

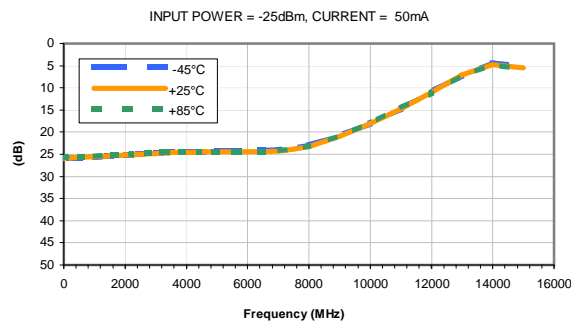

ISOLATION vs. CURRENT

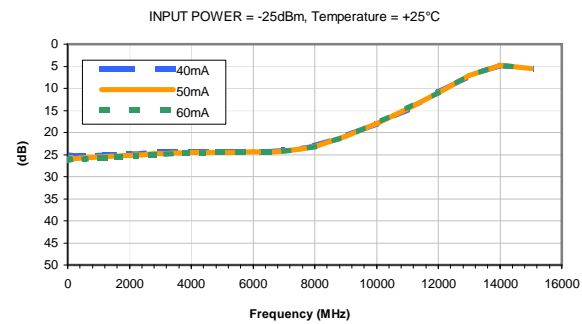

INPUT RETURN LOSS vs. TEMPERATURE

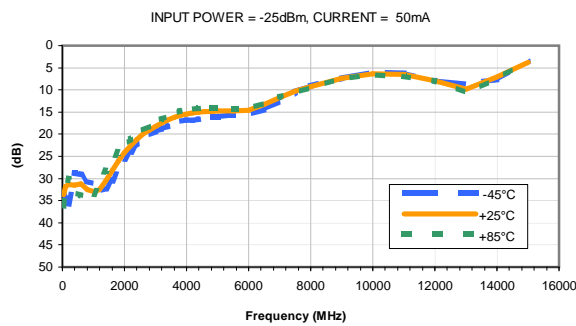

INPUT RETURN LOSS vs. CURRENT

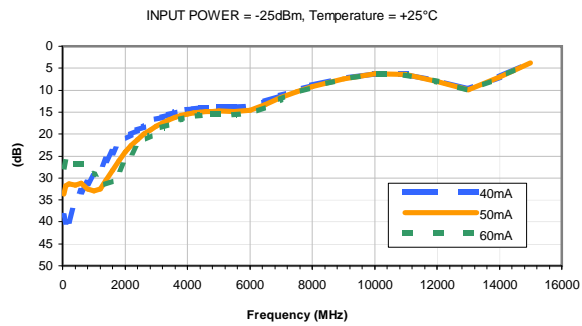

OUTPUT RETURN LOSS vs. TEMPERATURE

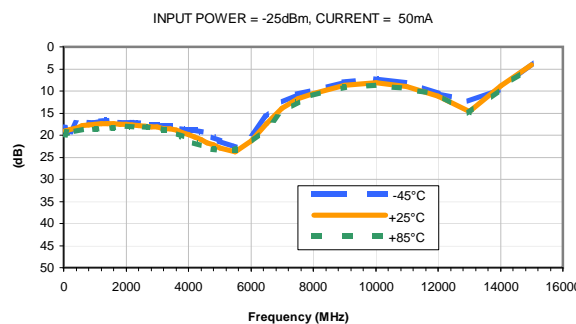

OUTPUT RETURN LOSS vs. CURRENT

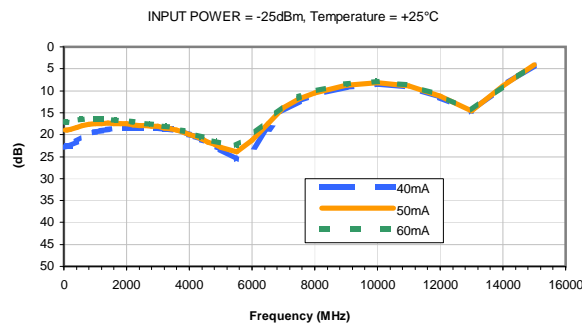

IF/RF MICROWAVE COMPONENTS • ISO 9001 ISO 14001 AS 9100 CERTIFIED • RoHS compliant
P.O. Box 350166, Brooklyn, New York 11235-0003 (718) 934-4500 Fax (718) 332-4661



The Design Engineers Search Engine finds the model you need, Instantly • For detailed performance specs & shopping online see



Typical Performance Curves

OUTPUT IP3 vs. TEMPERATURE

INPUT POWER = -25dBm, CURRENT = 50mA

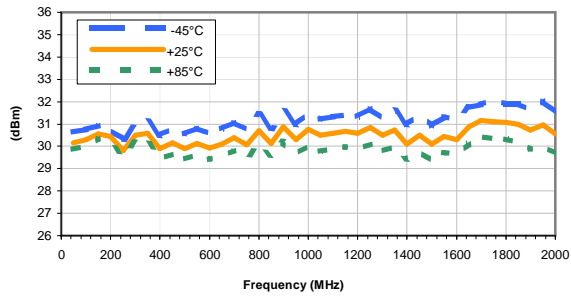

OUTPUT IP3 vs. CURRENT

INPUT POWER = -25dBm, Temperature = +25°C

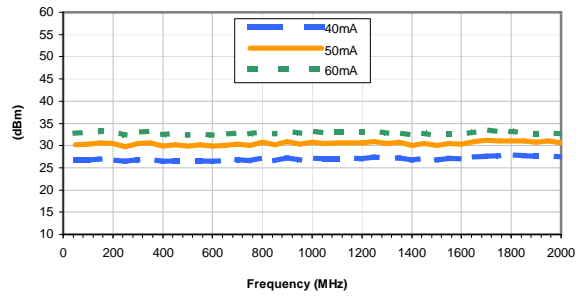

OUTPUT POWER at 1dB Compression vs. TEMPERATURE

CURRENT = 50mA

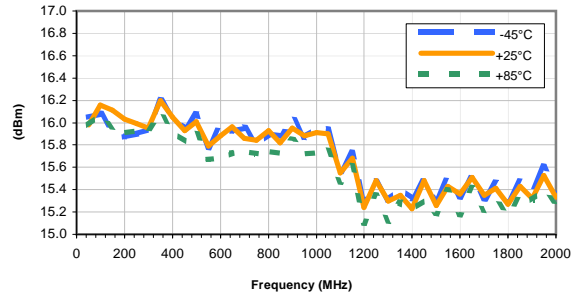

OUTPUT POWER at 1dB Compression vs. CURRENT

Temperature = +25°C

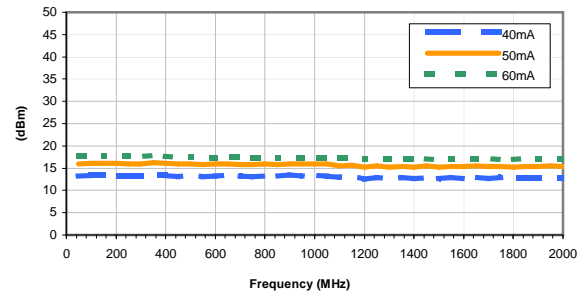

Noise Figure vs. TEMPERATURE

CURRENT = 50mA

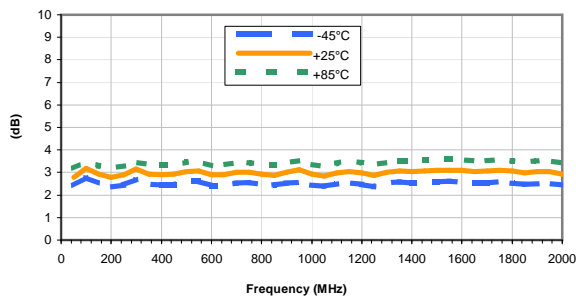

Noise Figure vs. CURRENT

Temperature = +25°C

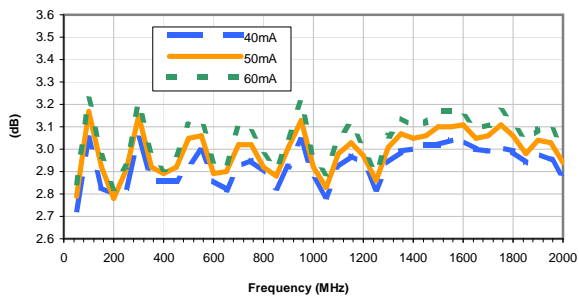

Outline Dimensions



PCB Land Pattern



Suggested Layout,
Tolerance to be within $\pm .002$

CASE #	A	B	C	D	E	F	G	H	J	K	L	M
DF782	.102 (2.59)	.090 (2.29)	.181 (4.60)	.173 (4.39)	.063 (1.60)	.167 (4.24)	.155 (3.94)	.059 (1.50)	.118 (3.00)	.015 (0.38)	.041 (1.04)	.016 (0.41)

CASE #	N	P	Q	WT. GRAM
DF782	.019 (0.48)	.065 (1.65)	.062 (1.57)	.2

Dimensions are in inches (mm). Tolerances: 2 Pl. $\pm .01$; 3Pl. $\pm .005$

Notes:

- Case material: Plastic.
- Termination finish:
 For RoHS Case Styles: Tin-Silver alloy plate over Nickel barrier or Matte-Tin.
 All models, (+) suffix. See model Data sheet.
 For RoHS-5 Case Styles: Tin-Lead plate. All models, no (+) suffix.



INTERNET <http://www.minicircuits.com>

P.O. Box 350166, Brooklyn, New York 11235-0003 (718) 934-4500 Fax (718) 332-4661

Distribution Centers NORTH AMERICA 800-654-7949 • 417-335-5935 • Fax 417-335-5945 • EUROPE 44-1252-832600 • Fax 44-1252-837010

Mini-Circuits ISO 9001 & ISO 14001 Certified

Tape & Reel Packaging TR-F55

DEVICE ORIENTATION IN T&R



Tape Width, mm	Device Cavity Pitch, mm	Reel Size, inches	Devices per Reel	
12	8	7	Small quantity standard (see note)	20
				50
				100
				200
				500
			Standard	1000

Note: Please consult individual model data sheet to determine device per reel availability.

Mini-Circuits carrier tape materials provide protection from ESD (Electro-Static Discharge) during handling and transportation. Tapes are static dissipative and comply with industry standards EIA-481/EIA-541.

Go to: www.minicircuits.com/pages/pdfs/tape.pdf



INTERNET <http://www.minicircuits.com>

P.O. Box 350166, Brooklyn, New York 11235-0003 (718) 934-4500 Fax (718) 332-4661

Distribution Centers NORTH AMERICA 800-654-7949 • 417-335-5935 • Fax 417-335-5945 • EUROPE 44-1252-832600 • Fax 44-1252-837010

Mini-Circuits ISO 9001 & ISO 14001 Certified

THIRD ANGLE PROJECTION



REVISIONS

REV	ECN No.	DESCRIPTION	DATE	DR	AUTH
A	M76190	CHANGED DISCRIPTION	04/01	GF	CT
B	M82575	UPDATED DRAWING	08/05/02	AV	LC
C	M102713	ADDED NOTE 2 & "...WITH SMOBC"	01/17/06	MMG	IL
D	M108434	UPDATED DRAWING PER TB-409+	11/14/06	PW	IG

SUGGESTED MOUNTING CONFIGURATION
FOR DF782 CASE STYLE, "mz" PIN CONNECTION



- NOTES:** 1. TRACE WIDTH IS SHOWN FOR ROGERS R04350B WITH DIELECTRIC THICKNESS .030" ± .002"; COPPER: 1/2 OZ. EACH SIDE. FOR OTHER MATERIALS TRACE WIDTH MAY NEED TO BE MODIFIED.
2. BOTTOM SIDE OF THE PCB IS CONTINUOUS GROUND PLANE.



DENOTES PCB COPPER LAYOUT WITH SMOBC (SOLDER MASK OVER BARE COPPER)



DENOTES COPPER LAND PATTERN FREE OF SOLDER MASK

UNLESS OTHERWISE SPECIFIED

INITIALS

DATE

DIMENSIONS ARE IN INCHES

DRAWN

AV

01/15/01

TOLERANCES ON:

CHECKED

YB

01/23/01

2 PL DECIMALS ± .005

APPROVED

DB

01/23/01

3 PL DECIMALS ±

ANGLES ±

FRACTIONS ±

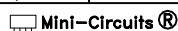

THIS DOCUMENT AND ITS CONTENTS ARE THE PROPERTY OF MINI-CIRCUITS. EXCEPT FOR USE EXPRESSLY GRANTED, IN WRITING, TO ITS VENDORS, VENDEE AND THE UNITED STATES GOVERNMENT, MINI-CIRCUITS RESERVES ALL PROPRIETARY DESIGN, USE, MANUFACTURING AND REPRODUCTION RIGHTS THERETO. THESE CONTENTS SHALL NOT BE USED, DUPLICATED OR DISCLOSED TO ANY OUTSIDE PARTY, IN WHOLE OR IN PART, WITHOUT WRITTEN PERMISSION OF MINI-CIRCUITS.



Mini-Circuits®

13 Neptune Avenue
Brooklyn NY 11235

PL, mz, DF782, GALI, TB-409-XXX+

SIZE

CODE IDENT

DRAWING NO:

REV:

A

15542

98-PL-019

D

FILE:

98PL019

SCALE:

10:1

SHEET:

1 OF 1

Evaluation Board and Circuit

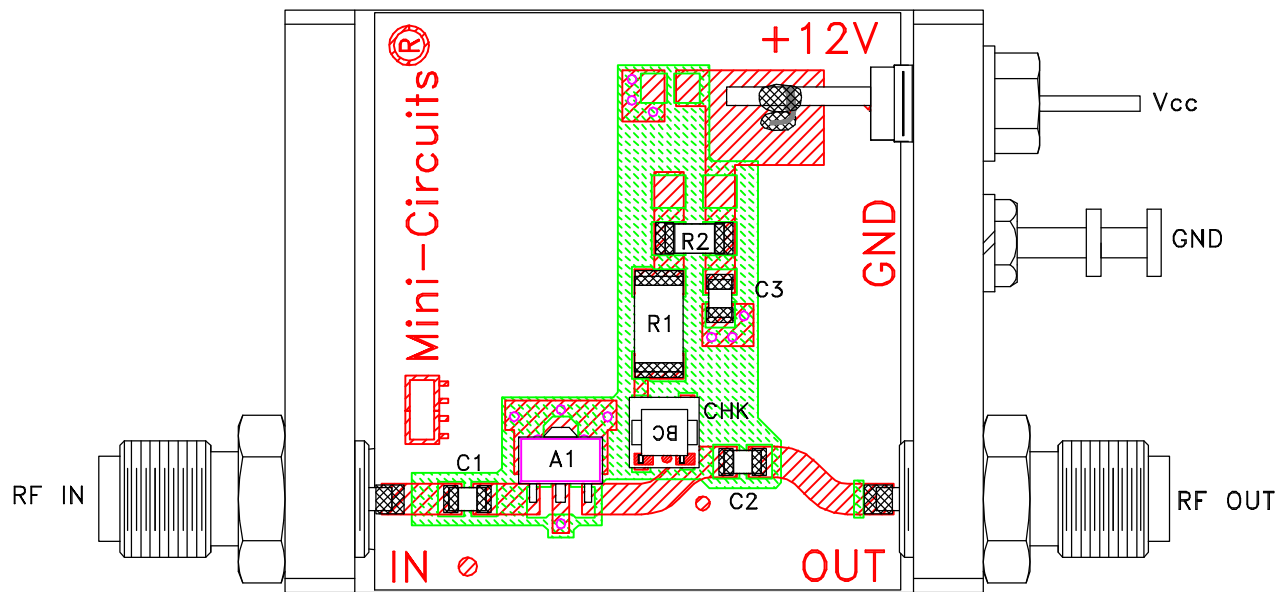

TB-409-52+

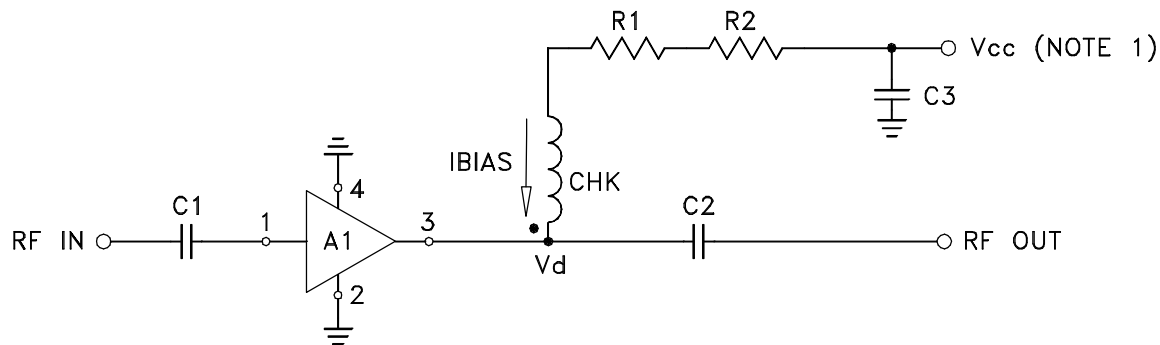

COMPONENT	VALUE
A1	Gali-52(+)
C1 (NOTE 4)	2400 pF
C2 (NOTE 4)	2400 pF
C3 (bypass)	0.1 uF
R1	143 Ohms, 0.75W
R2	8.25 Ohms, 0.25W
CHK	Mini-Circuits TCCH-80+

Schematic Diagram

NOTE:

1. Vcc voltage: $+12 \pm 0.2V$.
2. SMA Female connectors.
3. PCB material: Rogers R04350 or equivalent, dielectric constant=3.5, dielectric thickness=.030 inch.
4. Capacitors, C1 & C2 should be free of resonance up to the highest frequency specified.

 **Mini-Circuits®**

All Mini-Circuits products are manufactured under exacting quality assurance and control standards, and are capable of meeting published specifications after being subjected to any or all of the following physical and environmental test.

Specification	Test/Inspection Condition	Reference/Spec
Operating Temperature	-45° to 85°C or -40° to 85°C Ambient Environment	Individual Model Data Sheet
Storage Temperature	-65° to 150° C Ambient Environment	Individual Model Data Sheet
Thermal Shock	-55° to 100°C, 100 cycles	MIL-STD-202, Method 107, Condition A-3, except +100°C
Mechanical Shock	1.5Kg, 0.5 ms, 5 shock pulses, Y1 direction only	MIL-STD-883, Method 2002, Condition B, except Y1 direction only
Vibration (Variable Frequency)	50g peak	MIL-STD-883, Method 2007, Condition B
Autoclave	15 psig, 100% RH, 121°C, 96 hours	JESD22-A102, Condition C
HAST	130°C, 85% RH, 96 hours	JESD22-A110
Solderability	10X Magnification	J-STD-002, Para 4.2.5, Test S, 95% Coverage
Solder Reflow Heat	Sn-Pb Eutetic Process: 240°C peak Pb-Free Process: 260°C peak	J-STD-020, Table 4-1, 4-2 and 5-2; Figure 5-1
Moisture Sensitivity: Level 1	Bake at 125°C for 24 hours Soak at 85°C/85% RH for 168 hours, Reflow 3 cycles at 260°C peak	J-STD-020
Marking Resistance to Solvents	Isopropyl alcohol + mineral spirits at 25°C; terpene defluxer at 25°C; distilled water + proylene glycol monomethyl ether +	MIL-STD-202, Method 215



All Mini-Circuits products are manufactured under exacting quality assurance and control standards, and are capable of meeting published specifications after being subjected to any or all of the following physical and environmental test.

Specification	Test/Inspection Condition	Reference/Spec
	monoethanolamine at 63°C to 70°C	