



COAXIAL

Fixed Attenuator

FW-A-SERIES

Mini-Circuits

50Ω Up to 2W DC to 12000 MHz

THE BIG DEAL

- Wideband coverage, DC to 12000 MHz
- Up to 2 Watt rating
- Rugged unibody construction
- Off-the-shelf availability
- Very low cost

APPLICATIONS

- Impedance matching
- Signal level adjustment



Generic photo used for illustration purposes only

Model No.	FW-A-SERIES
Case Style	FF704
Connectors	SMA

+RoHS Compliant

The +Suffix identifies RoHS Compliance. See our web site for RoHS Compliance methodologies and qualifications

PRODUCT OVERVIEW

Mini-Circuits' FW-A series are fixed attenuators from DC to 12000 MHz frequency range with excellent flatness in attenuation. FW-A series is available with nominal attenuation of 1 to 20 dB. This attenuator series support testing and measurement application. Precise performance, excellent VSWR and rugged unibody construction makes the model ideal solution for systems requiring precise attenuation across very wide frequency range.

KEY FEATURES

Feature	Advantages
Rugged construction	Excellent durability for a long lifetime of use
Up to 2 Watt rating	Good power handling
Excellent VSWR	Well-matched for 50 Ω systems
Flat attenuation	Good performance over the band.





COAXIAL

Fixed Attenuator

FW-9A+

MAXIMUM RATINGS

Operating Temperature	-40°C to 85°C
Storage Temperature	-55°C to 100°C

Permanent damage may occur if any of these limits are exceeded.

OUTLINE DRAWING

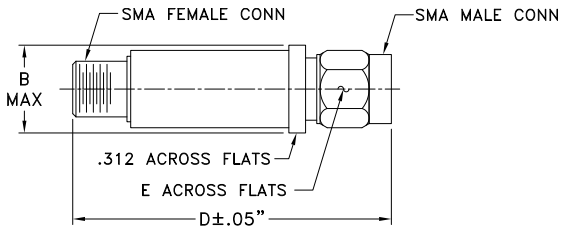

OUTLINE DIMENSIONS (Inch/mm)

B	D	E	wt
.410	1.43	.312	grams
10.41	36.32	7.92	10.0

Note: Please refer to case style drawing for details

ELECTRICAL SCHEMATIC

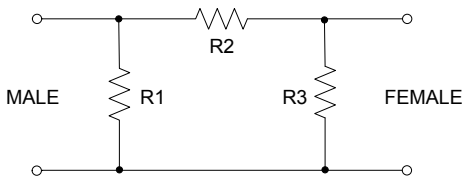

ELECTRICAL SPECIFICATIONS AT 25°C

Parameter	Condition (MHz)	Min.	Typ.	Max.	Unit
Frequency Range		DC	-	12000	MHz
Attenuation ¹	10	-	9	-	dB
	DC - 3000	8.7	9.1	9.6	
	3000 - 8000	8.9	9.4	9.9	
VSWR	DC - 3000	-	1.10	1.40	:1
	3000 - 8000	-	1.15	1.50	
	8000 - 12000	-	1.20	-	
Input Power ²	DC - 12000	-	-	1.1	W

1. Attenuation varies by 0.3 dB max. over temperature.
 2. RF power at 25°C is 1.1W; Derate linearly to 0.8W at 85°C

TYPICAL PERFORMANCE DATA

Frequency (MHz)	Attenuation (dB)	VSWR (:1)
10	8.94	1.09
100	8.95	1.10
500	8.99	1.10
1000	9.04	1.10
2000	9.11	1.10
3000	9.17	1.10
5000	9.30	1.11
6000	9.37	1.11
8000	9.50	1.08
9000	9.56	1.05
9500	9.58	1.04
10000	9.59	1.05
10500	9.61	1.06
11000	9.62	1.08
12000	9.64	1.13

FW-9A+ ATTENUATION

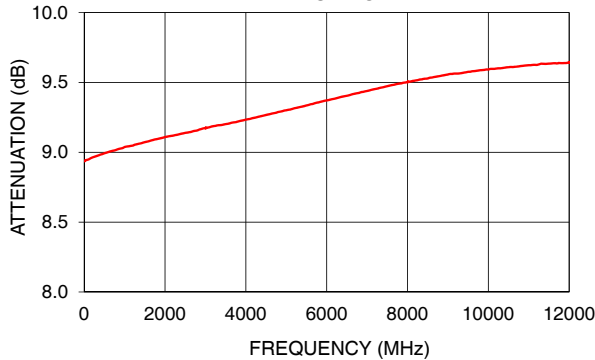

FW-9A+ VSWR

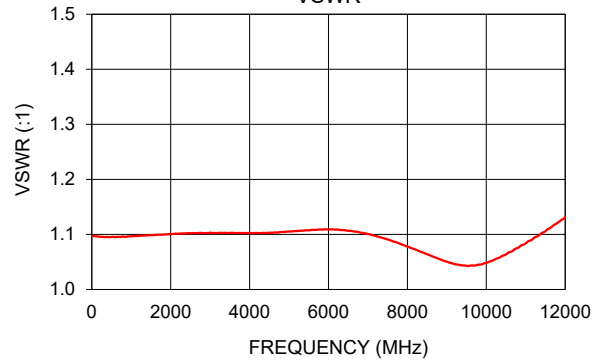

NOTES

- A. Performance and quality attributes and conditions not expressly stated in this specification document are intended to be excluded and do not form a part of this specification document.
- B. Electrical specifications and performance data contained in this specification document are based on Mini-Circuit's applicable established test performance criteria and measurement instructions.
- C. The parts covered by this specification document are subject to Mini-Circuits standard limited warranty and terms and conditions (collectively, "Standard Terms"); Purchasers of this part are entitled to the rights and benefits contained therein. For a full statement of the standard. Terms and the exclusive rights and remedies thereunder, please visit Mini-Circuits' website at www.minicircuits.com/MCLStore/terms.jsp



Coaxial Fixed Attenuator

FW-9A+

Typical Performance Data

FREQ.	ATTENUATION	VSWR
(MHz)	(dB)	(:1)
10	8.94	1.10
20	8.94	1.10
100	8.95	1.10
200	8.96	1.10
300	8.97	1.10
400	8.98	1.10
500	8.99	1.10
600	9.00	1.10
700	9.01	1.10
800	9.02	1.10
900	9.03	1.10
1000	9.04	1.10
1200	9.05	1.10
1400	9.06	1.10
1600	9.08	1.10
1800	9.09	1.10
2000	9.11	1.10
2200	9.12	1.10
2400	9.13	1.10
2600	9.14	1.10
2800	9.16	1.10
3000	9.17	1.10
3200	9.19	1.10
3400	9.20	1.10
3600	9.21	1.10
3800	9.22	1.10
4000	9.23	1.10
4200	9.25	1.10
4400	9.26	1.10
4600	9.27	1.10
4800	9.29	1.10
5000	9.30	1.11
5200	9.32	1.11
5400	9.33	1.11
5600	9.34	1.11
5800	9.36	1.11
6000	9.37	1.11
6200	9.38	1.11
6400	9.40	1.11
6600	9.41	1.11
6800	9.42	1.10
7000	9.44	1.10
7200	9.45	1.10
7400	9.47	1.09
7600	9.48	1.09
7800	9.49	1.08
8000	9.50	1.08
8200	9.51	1.07
8400	9.53	1.07
8600	9.53	1.06
8800	9.55	1.06
9000	9.56	1.05
9200	9.56	1.05
9400	9.57	1.04
9600	9.58	1.04
10000	9.59	1.05
11000	9.62	1.08
11500	9.63	1.11
12000	9.64	1.13

Typical Performance Curves

ATTENUATION

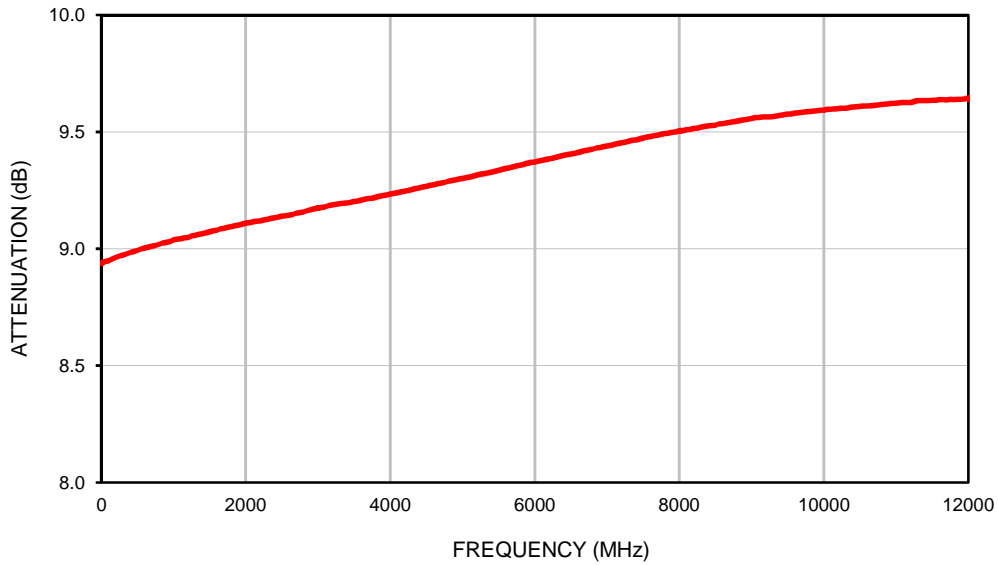

VSWR

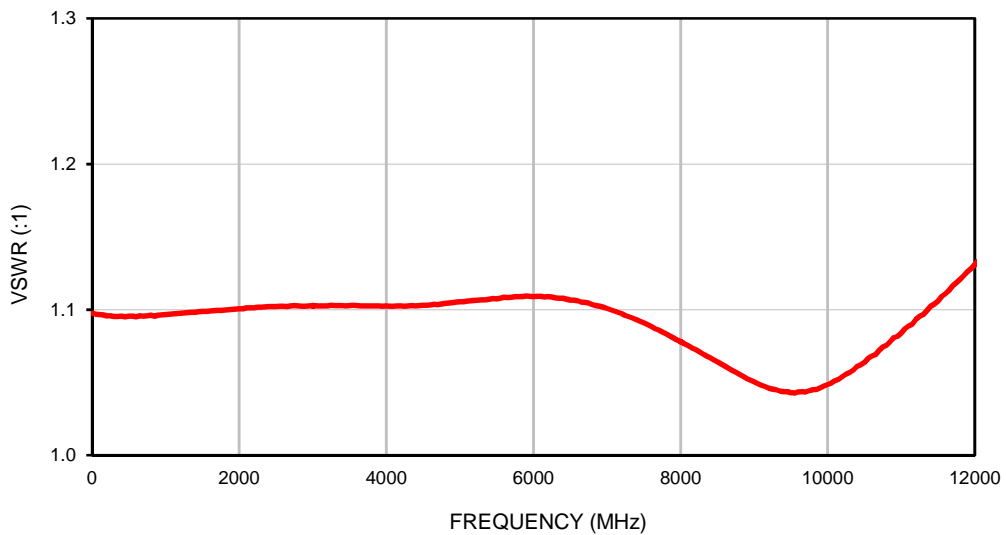

Case Style

FF

FF704

Outline Dimensions

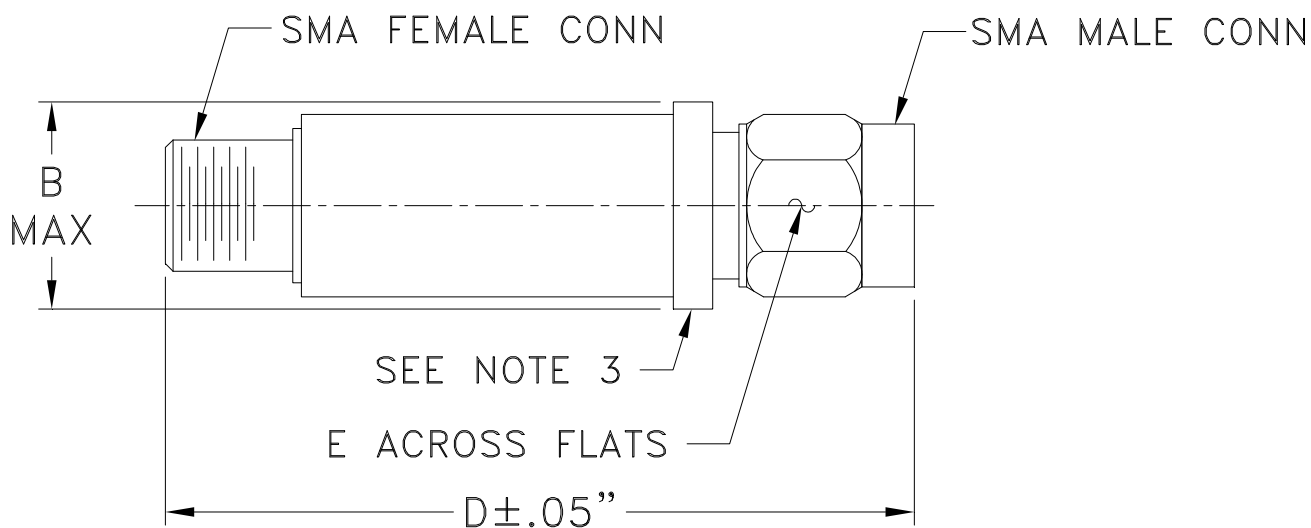

CASE #.	A	B	C	D	E	WT GRAMS
FF704	--	.410 (10.41)	--	1.43 (36.32)	.312 (7.92)	10.0

Dimensions are in inches (mm). Tolerances: 2Pl. ± .04; 3Pl. ± .030

Notes:

1. Case material: Stainless steel.
2. Case finish: Gold plated.
3. Round Flange may have .312 Across Flats in some models.

Mini-Circuits[®]
ISO 9001 ISO 14001 CERTIFIED

ALL NEW
minicircuits.com

P.O. Box 350166, Brooklyn, New York 11235-0003 (718) 934-4500 Fax (718) 332-4661 For detailed performance specs & shopping online see Mini-Circuits web site



The Design Engineers Search Engine Provides ACTUAL Data Instantly From MINI-CIRCUITS At: www.minicircuits.com

RF/IF MICROWAVE COMPONENTS

All Mini-Circuits products are manufactured under exacting quality assurance and control standards, and are capable of meeting published specifications after being subjected to any or all of the following physical and environmental test.

Specification	Test/Inspection Condition	Reference/Spec
Operating Temperature	-40° to 85° C Ambient Environment	Individual Model Data Sheet
Storage Temperature	-55° to 100° C Ambient Environment	Individual Model Data Sheet
Thermal Shock	-55° to 100°C, 5cycles	MIL-STD-202, Method 107, Condition A, except +100°C
Vibration (High Frequency)	20g peak, 10-2000 Hz, 12 times in each of three perpendicular directions (total 36)	MIL-STD-202, Method 204, Condition D
Mechanical Shock	75g, 6ms , Half Sine, 3 shocks each direction 3 axes (total 18)	MIL-STD-202, Method 213, Condition B