



COAXIAL

# Fixed Attenuator

## FW-A-SERIES

Mini-Circuits

50Ω Up to 2W DC to 12000 MHz

### THE BIG DEAL

- Wideband coverage, DC to 12000 MHz
- Up to 2 Watt rating
- Rugged unibody construction
- Off-the-shelf availability
- Very low cost

### APPLICATIONS

- Impedance matching
- Signal level adjustment



Generic photo used for illustration purposes only

Model No.	FW-A-SERIES
Case Style	FF704
Connectors	SMA

#### +RoHS Compliant

The +Suffix identifies RoHS Compliance. See our web site for RoHS Compliance methodologies and qualifications

### PRODUCT OVERVIEW

Mini-Circuits' FW-A series are fixed attenuators from DC to 12000 MHz frequency range with excellent flatness in attenuation. FW-A series is available with nominal attenuation of 1 to 20 dB. This attenuator series support testing and measurement application. Precise performance, excellent VSWR and rugged unibody construction makes the model ideal solution for systems requiring precise attenuation across very wide frequency range.

### KEY FEATURES

Feature	Advantages
Rugged construction	Excellent durability for a long lifetime of use
Up to 2 Watt rating	Good power handling
Excellent VSWR	Well-matched for 50 Ω systems
Flat attenuation	Good performance over the band.





COAXIAL

# Fixed Attenuator

FW-10A+

## MAXIMUM RATINGS

Operating Temperature	-40°C to 85°C
Storage Temperature	-55°C to 100°C

Permanent damage may occur if any of these limits are exceeded.

## OUTLINE DRAWING

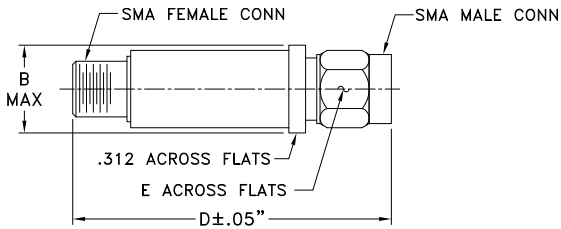

## OUTLINE DIMENSIONS (Inch/mm)

B	D	E	wt
.410	1.43	.312	grams
10.41	36.32	7.92	10.0

Note: Please refer to case style drawing for details

## ELECTRICAL SCHEMATIC

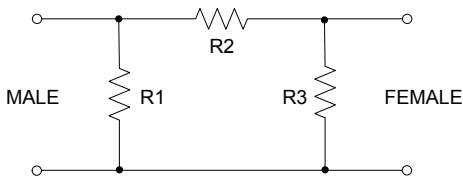

## ELECTRICAL SPECIFICATIONS AT 25°C

Parameter	Condition (MHz)	Min.	Typ.	Max.	Unit
Frequency Range		DC	-	12000	MHz
Attenuation <sup>1</sup>	10	-	10	-	dB
	DC - 3000	9.7	10.1	10.5	
	3000 - 8000	9.8	10.3	11.0	
VSWR	8000 - 12000	10.1	10.7	11.2	:1
	DC - 3000	-	1.10	1.45	
	3000 - 8000	-	1.15	1.55	
Input Power <sup>2</sup>	8000 - 12000	-	1.20	-	W
	DC - 12000	-	-	1.7	

- Attenuation varies by 0.3 dB max. over temperature.
- RF power at 25°C is 1.7W; Derate linearly to 1.0W at 85°C

## TYPICAL PERFORMANCE DATA

Frequency (MHz)	Attenuation (dB)	VSWR (:1)
10	9.94	1.12
100	9.95	1.13
500	10.00	1.12
1000	10.03	1.12
2000	10.10	1.12
3000	10.16	1.11
5000	10.29	1.12
6000	10.37	1.11
8000	10.51	1.07
9000	10.57	1.10
9500	10.60	1.12
10000	10.62	1.13
10500	10.63	1.14
11000	10.64	1.13
12000	10.65	1.08

FW-10A+ ATTENUATION

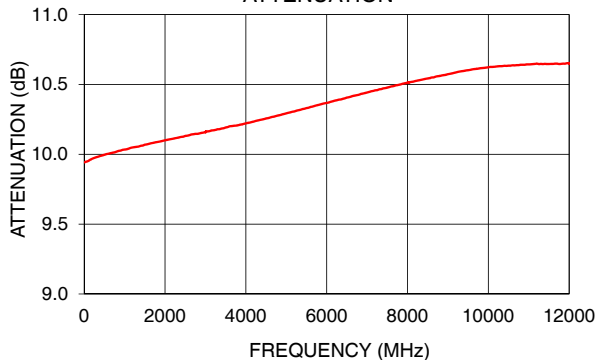

FW-10A+ VSWR

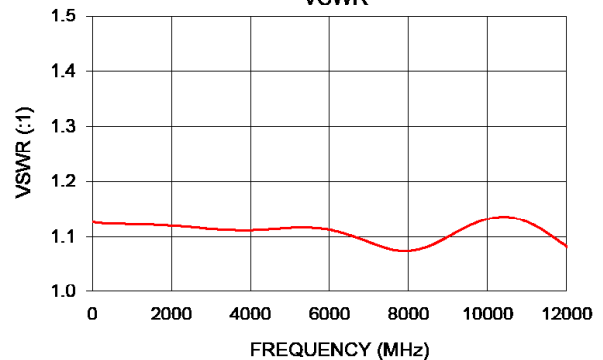

### NOTES

- Performance and quality attributes and conditions not expressly stated in this specification document are intended to be excluded and do not form a part of this specification document.
- Electrical specifications and performance data contained in this specification document are based on Mini-Circuit's applicable established test performance criteria and measurement instructions.
- The parts covered by this specification document are subject to Mini-Circuits standard limited warranty and terms and conditions (collectively, "Standard Terms"); Purchasers of this part are entitled to the rights and benefits contained therein. For a full statement of the standard. Terms and the exclusive rights and remedies thereunder, please visit Mini-Circuits' website at [www.minicircuits.com/MCLStore/terms.jsp](http://www.minicircuits.com/MCLStore/terms.jsp)



# Coaxial Fixed Attenuator

# FW-10A+

## Typical Performance Data

FREQ.	ATTENUATION	VSWR
(MHz)	(dB)	(:1)
10	9.94	1.13
20	9.94	1.13
50	9.95	1.13
100	9.95	1.13
200	9.97	1.12
300	9.98	1.12
400	9.99	1.12
500	10.00	1.12
600	10.00	1.12
700	10.01	1.12
800	10.02	1.12
900	10.03	1.12
1000	10.03	1.12
1200	10.05	1.12
1400	10.06	1.12
1600	10.07	1.12
1800	10.09	1.12
2000	10.10	1.12
2200	10.11	1.12
2400	10.12	1.12
2600	10.14	1.12
2800	10.15	1.12
3000	10.16	1.11
3200	10.17	1.11
3400	10.18	1.11
3600	10.20	1.11
3800	10.21	1.11
4000	10.22	1.11
4200	10.23	1.11
4400	10.25	1.11
4600	10.26	1.11
4800	10.28	1.11
5000	10.29	1.12
5200	10.31	1.12
5400	10.32	1.12
5600	10.34	1.12
5800	10.35	1.11
6000	10.37	1.11
6200	10.38	1.11
6400	10.40	1.11
6600	10.41	1.10
6800	10.43	1.10
7000	10.44	1.09
7200	10.46	1.09
7400	10.47	1.08
7600	10.49	1.08
7800	10.50	1.07
8000	10.51	1.07
8200	10.52	1.08
8400	10.54	1.08
8600	10.55	1.09
8800	10.56	1.09
9000	10.57	1.10
9200	10.59	1.11
9400	10.60	1.12
9600	10.61	1.12
10000	10.62	1.13
11000	10.64	1.13
11500	10.65	1.11
12000	10.65	1.08



## Typical Performance Curves

### ATTENUATION

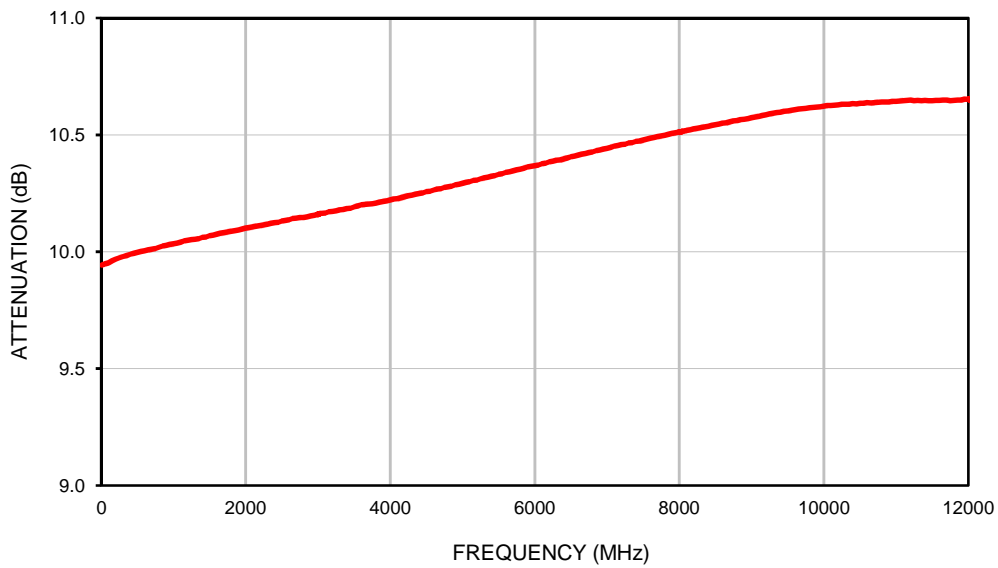

### VSWR

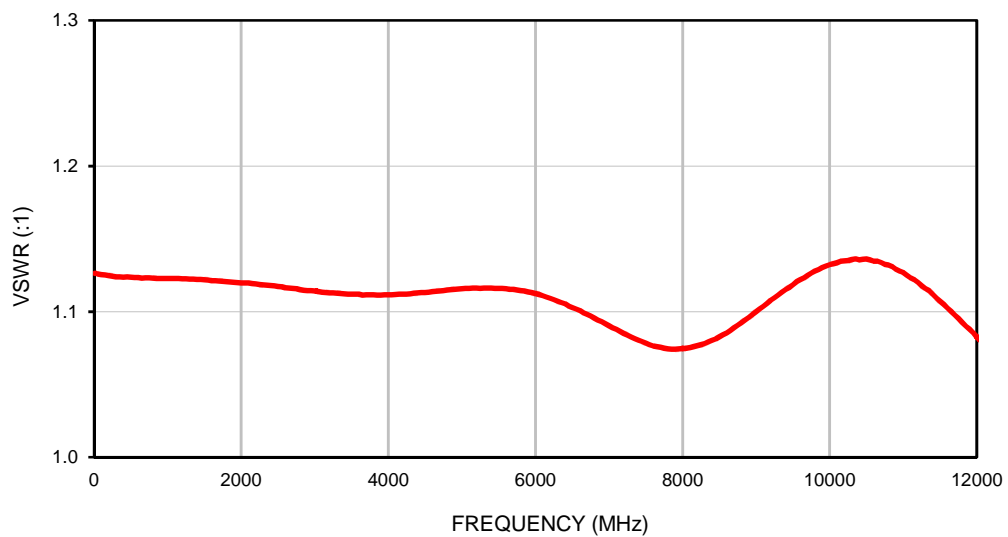

# Case Style

# FF

## FF704

### Outline Dimensions

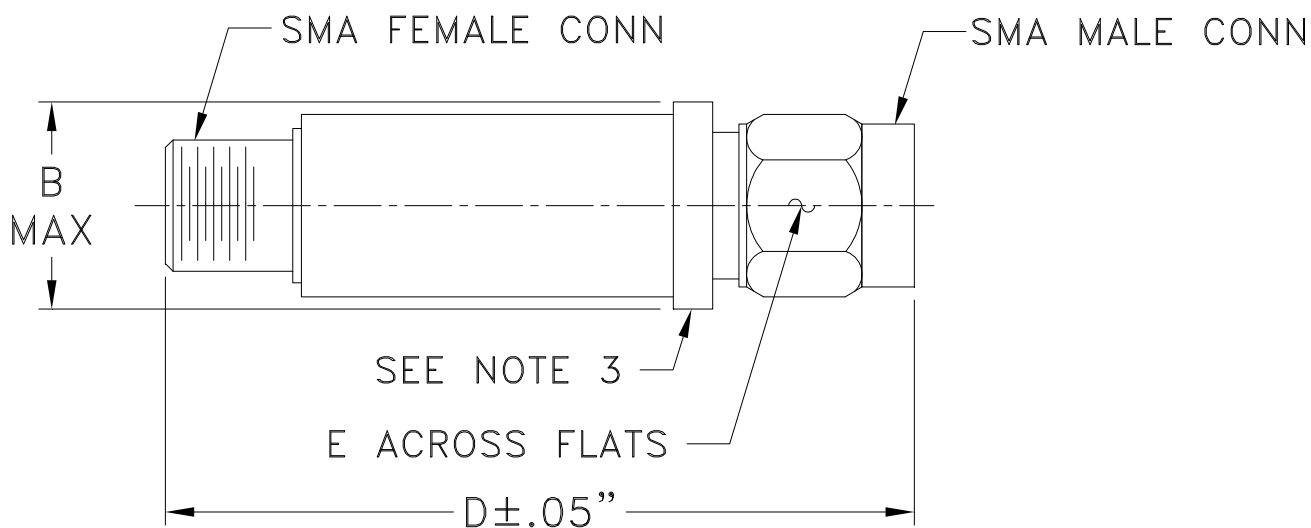

CASE #.	A	B	C	D	E	WT GRAMS
FF704	--	.410 (10.41)	--	1.43 (36.32)	.312 (7.92)	10.0

Dimensions are in inches (mm). Tolerances: 2Pl. ± .04; 3Pl. ± .030

#### Notes:

1. Case material: Stainless steel.
2. Case finish: Gold plated.
3. Round Flange may have .312 Across Flats in some models.

**Mini-Circuits®**  
ISO 9001 ISO 14001 CERTIFIED

ALL NEW  
minicircuits.com

P.O. Box 350166, Brooklyn, New York 11235-0003 (718) 934-4500 Fax (718) 332-4661 For detailed performance specs & shopping online see Mini-Circuits web site



The Design Engineers Search Engine Provides ACTUAL Data Instantly From MINI-CIRCUITS At: [www.minicircuits.com](http://www.minicircuits.com)

RF/IF MICROWAVE COMPONENTS

All Mini-Circuits products are manufactured under exacting quality assurance and control standards, and are capable of meeting published specifications after being subjected to any or all of the following physical and environmental test.

<b>Specification</b>	<b>Test/Inspection Condition</b>	<b>Reference/Spec</b>
Operating Temperature	-40° to 85° C Ambient Environment	Individual Model Data Sheet
Storage Temperature	-55° to 100° C Ambient Environment	Individual Model Data Sheet
Thermal Shock	-55° to 100°C, 5cycles	MIL-STD-202, Method 107, Condition A, except +100°C
Vibration (High Frequency)	20g peak, 10-2000 Hz, 12 times in each of three perpendicular directions (total 36)	MIL-STD-202, Method 204, Condition D
Mechanical Shock	75g, 6ms , Half Sine, 3 shocks each direction 3 axes (total 18)	MIL-STD-202, Method 213, Condition B