



MICROWAVE

Gain Equalizer

EQY-4-283+

50Ω 4dB DC to 28 GHz

THE BIG DEAL

- 4.3 dB Slope from DC to 28 GHz , can work up to 30 GHz
- Small Package 2 x 2 mm MCLP
- Excellent Return Loss, 20 dB typ.
- Patent pending

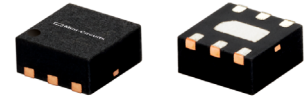

Generic photo used for illustration purposes only

CASE STYLE: MC1630-1

APPLICATIONS

- Cellular Infrastructure
- 5G
- Wideband Communications
- Test Instrumentation
- Defense

+RoHS Compliant

The +Suffix identifies RoHS Compliance. See our website for methodologies and qualifications

PRODUCT OVERVIEW

EQY-4-283+ is an absorptive Gain Equalizer fabricated using highly repetitive GaAs IPD MMIC process incorporating resistors, capacitors and inductors having negative insertion loss slope. EQY-4-283+ has a nominal attenuation slope of 4.3 dB and is packaged in tiny 2 x 2 mm, 6-Lead MCLP™ package.

KEY FEATURES

Feature	Advantages
Negative Insertion Loss Slope vs. Frequency	Useful for compensating negative gain slope of amplifiers, receivers, transmitters to achieve flat gain versus frequency.
Wide range of values 3,4,5,6 dB	Enables circuit designer to change nominal insertion loss values without board redesign making the EQY series ideal for select at test application.
Wideband operation, DC to 28 GHz	Supports a wide array of applications including wireless cellular, microwave communications, satellite, defense and aerospace, medical broadband and optic applications.
Excellent Power Handling Capability up to +30 dBm	Enables its use at the output of a variety of amplifiers
Small Size and simple to use (2 mm x 2 mm)	As a single chip solution, the EQY series occupies less board space than a lumped or distributed element approach, minimizes component count and ensures repeatable performance over wide frequency range.

*GaAs IPD (Gallium Arsenide Integrated Passive Device)

REV. A
ECO-014607
EQY-4-283+
MCL NY
220817





MICROWAVE

Gain Equalizer

EQY-4-283+

50Ω 4dB DC to 28 GHz

ELECTRICAL SPECIFICATIONS¹ AT 25°C, 50Ω, UNLESS OTHERWISE NOTED.

Parameter	Condition (GHz)	Min.	Typ.	Max.	Units
Frequency Range		DC		28	GHz
Insertion Loss	0.01	4.6	4.9	5.2	dB
	10	3.7	4.0	4.3	
	20	1.3	1.8	2.3	
	28	0.3	0.6	1.2	
	30	—	0.5	—	
VSWR	0.01 -10	—	1.14	—	:1
	10 - 20	—	1.11	—	
	20 -28	—	1.18	—	
	28 - 30	—	1.21	—	

1. Measured on Mini-Circuits Characterization Test Board TB-EQY-4-283+. See Characterization Test Circuit (Fig. 1)

MAXIMUM RATINGS²

Parameter	Ratings
Operating Case Temperature	-55°C to 105°C
Storage Temperature	-65°C to 150°C
RF Input Power ³	+30 dBm

2. Permanent damage may occur if any of these limits are exceeded.

3. Derates linearly to 26 dBm at 105°C





MICROWAVE

Gain Equalizer

EQY-4-283+

Mini-Circuits

50Ω 4dB DC to 28 GHz

SIMPLIFIED SCHEMATIC & PAD DESCRIPTION

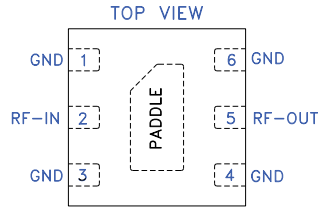
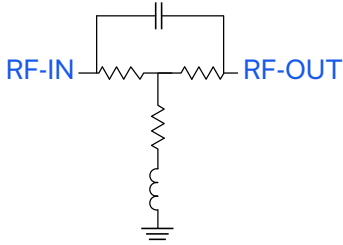

Function	Pad Number	Description
RF-IN	2	RF-Input pad
RF-OUT	5	RF-Output pad
GND	1,3,4,6 & Paddle	Ground

CHARACTERIZATION TEST CIRCUIT

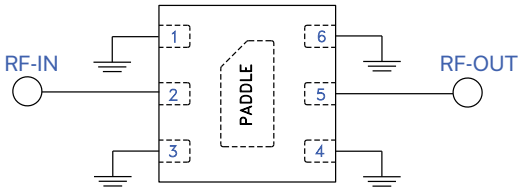

Fig 1. Block Diagram of Test Circuit used for characterization. Test Board TB-EQY-4-283+
Conditions: Attenuation & Return Loss Pin=0 dBm

PRODUCT MARKING



Marking may contain other features or characters for internal lot control



MICROWAVE

Gain Equalizer

EQY-4-283+

Mini-Circuits

50Ω 4dB DC to 28 GHz

ADDITIONAL DETAILED TECHNICAL INFORMATION IS AVAILABLE ON OUR DASH BOARD. TO ACCESS [CLICK HERE](#)

Performance Data	Data Table
	Swept Graphs
Case Style	MC1630-1 Plastic package, Lead finish: Matte-tin
Tape & Reel Standard quantities available on reel	F66 7" reels with 20, 50, 100, 200, 500,1K or 2K devices
Suggested Layout for PCB Design	PL-663
Evaluation Board	TB-EQY-4-283+ & TB-EQY-4-283C+
Environmental Ratings	ENV08T1

ESD RATING

Human Body Model (HBM): Class 2 ee with ANSI/ESD STM 5.1 - 2001 Machine.

MSL RATING

Moisture Sensitivity: MSL1 in accordance with IPC/JEDEC J-STD-020D.

MSL TEST FLOW CHART

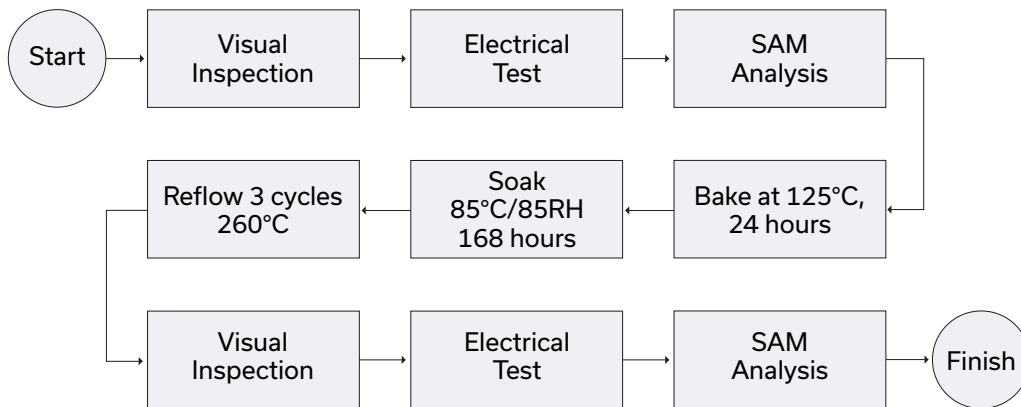

- NOTES**
- A. Performance and quality attributes and conditions not expressly stated in this specification document are intended to be excluded and do not form a part of this specification document.
 - B. Electrical specifications and performance data contained in this specification document are based on Mini-Circuit's applicable established test performance criteria and measurement instructions.
 - C. The parts covered by this specification document are subject to Mini-Circuits standard limited warranty and terms and conditions (collectively, "Standard Terms"); Purchasers of this part are entitled to the rights and benefits contained therein. For a full statement of the standard terms and the exclusive rights and remedies thereunder, please visit Mini-Circuits' website at www.minicircuits.com/terms/viewterm.html



Typical Performance Data

FREQ. (MHz)	INSERTION LOSS			INPUT VSWR			OUTPUT VSWR		
	(dB)			(:1)			(:1)		
	@-55°C	@25°C	@+105°C	@-55°C	@25°C	@+105°C	@-55°C	@25°C	@+105°C
10	4.81	4.91	4.92	1.18	1.20	1.20	1.19	1.20	1.21
100	4.81	4.92	4.92	1.11	1.13	1.14	1.13	1.14	1.14
500	4.82	4.93	4.93	1.11	1.13	1.13	1.12	1.13	1.13
1000	4.82	4.93	4.92	1.12	1.13	1.13	1.12	1.13	1.13
2000	4.83	4.95	4.92	1.15	1.15	1.16	1.14	1.15	1.16
3000	4.77	4.88	4.85	1.18	1.18	1.19	1.17	1.18	1.19
4000	4.71	4.82	4.78	1.22	1.20	1.21	1.21	1.21	1.22
5000	4.63	4.74	4.70	1.22	1.19	1.20	1.23	1.22	1.22
6000	4.54	4.65	4.61	1.22	1.19	1.20	1.24	1.23	1.23
7000	4.43	4.56	4.52	1.24	1.22	1.23	1.26	1.26	1.27
8000	4.29	4.42	4.37	1.28	1.26	1.26	1.29	1.30	1.30
9000	4.10	4.22	4.15	1.28	1.24	1.23	1.29	1.28	1.26
10000	3.87	3.99	3.91	1.17	1.13	1.11	1.19	1.16	1.15
11000	3.68	3.81	3.75	1.08	1.06	1.05	1.12	1.09	1.09
12000	3.54	3.67	3.62	1.21	1.17	1.16	1.22	1.20	1.18
13000	3.35	3.49	3.42	1.25	1.21	1.19	1.26	1.24	1.22
14000	3.11	3.25	3.15	1.18	1.13	1.09	1.21	1.20	1.17
15000	2.88	2.99	2.90	1.07	1.04	1.06	1.19	1.17	1.16
16000	2.66	2.77	2.70	1.14	1.13	1.13	1.24	1.21	1.20
17000	2.41	2.55	2.48	1.16	1.16	1.15	1.22	1.23	1.20
18000	2.14	2.28	2.21	1.12	1.11	1.09	1.13	1.15	1.13
19000	1.87	2.01	1.93	1.05	1.03	1.05	1.04	1.04	1.04
20000	1.64	1.80	1.74	1.14	1.17	1.18	1.14	1.15	1.16
21000	1.53	1.63	1.56	1.35	1.27	1.22	1.34	1.25	1.20
22000	1.37	1.46	1.39	1.33	1.28	1.21	1.32	1.26	1.20
23000	1.12	1.28	1.20	1.20	1.24	1.21	1.18	1.23	1.20
24000	0.93	1.09	1.04	1.26	1.23	1.22	1.20	1.22	1.21
25000	0.82	0.95	0.92	1.36	1.26	1.28	1.31	1.25	1.26
26000	0.66	0.83	0.83	1.26	1.27	1.31	1.28	1.27	1.30
27000	0.52	0.70	0.69	1.19	1.21	1.22	1.23	1.23	1.23
28000	0.46	0.59	0.55	1.16	1.10	1.06	1.21	1.15	1.13
29000	0.38	0.51	0.45	1.04	1.06	1.06	1.12	1.07	1.06
30000	0.32	0.49	0.43	1.08	1.15	1.17	1.04	1.10	1.11
31000	0.40	0.56	0.53	1.37	1.37	1.40	1.39	1.35	1.39
32000	0.51	0.64	0.65	1.71	1.60	1.62	1.74	1.59	1.63
33000	0.32	0.60	0.54	1.62	1.58	1.58	1.61	1.60	1.61
34000	0.18	0.42	0.26	1.29	1.27	1.21	1.32	1.36	1.31
35000	0.19	0.36	0.24	1.02	1.08	1.19	1.18	1.22	1.27
36000	0.38	0.57	0.53	1.36	1.42	1.49	1.45	1.45	1.48
37000	0.61	0.77	0.74	1.61	1.55	1.50	1.61	1.50	1.43
38000	0.55	0.78	0.70	1.43	1.39	1.31	1.34	1.29	1.19
39000	0.43	0.70	0.62	1.24	1.21	1.22	1.10	1.06	1.10
40000	0.51	0.82	0.68	1.26	1.28	1.31	1.15	1.22	1.27

Typical Performance Curves

INSERTION LOSS vs. TEMPERATURE
INPUT POWER = -5 dBm

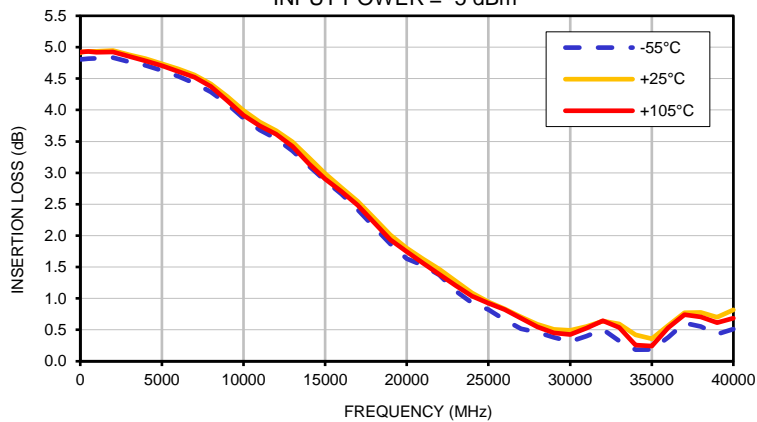

INPUT VSWR vs. TEMPERATURE
INPUT POWER = -5 dBm

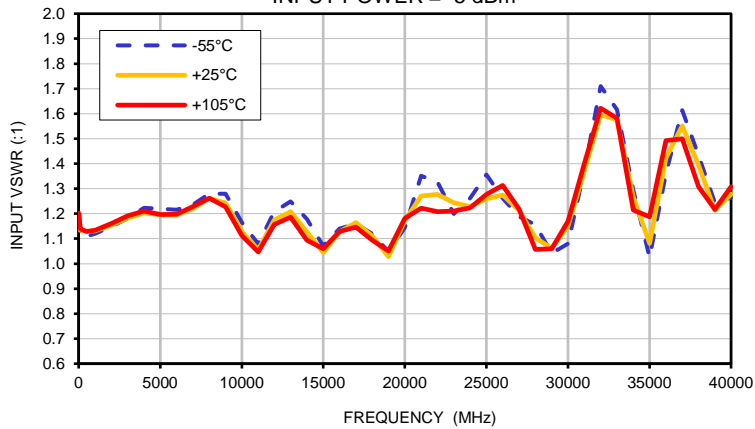

OUTPUT VSWR vs. TEMPERATURE
INPUT POWER = -5 dBm

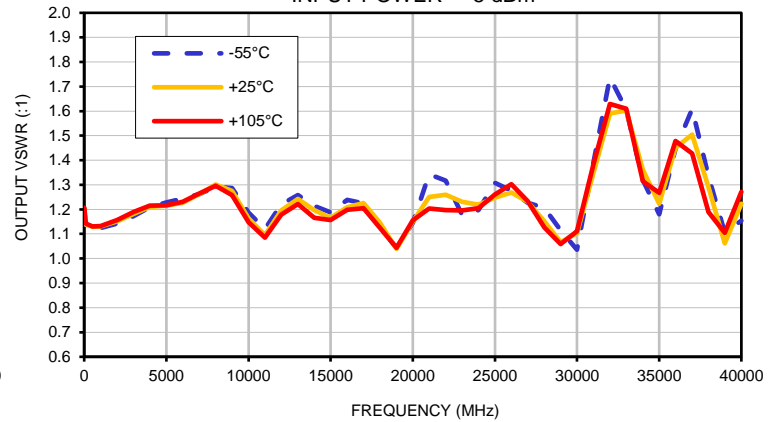

Outline Dimensions

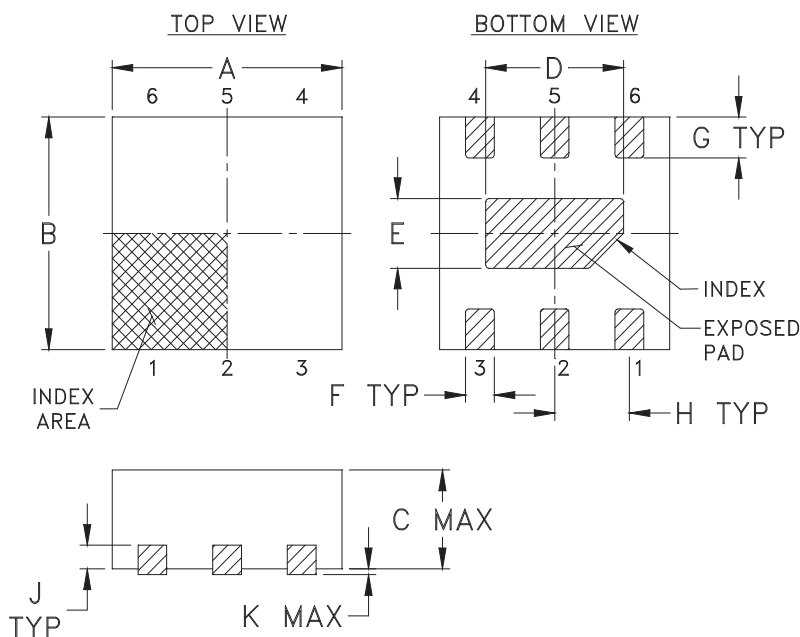

PCB Land Pattern

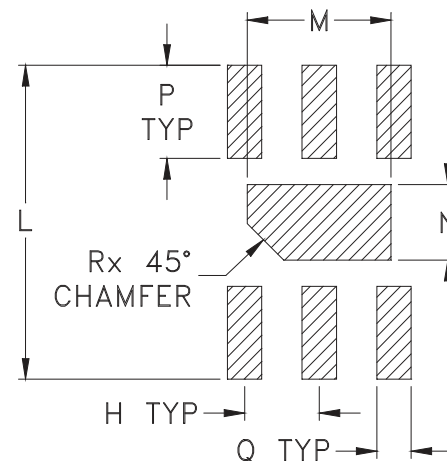

Suggested Layout,
Tolerance to be within $\pm .002$

CASE #.	A	B	C	D	E	F	G	H	J	K	L	M	N	P
MC1630-1	.079 (2.00)	.079 (2.00)	.039 (1.00)	.047 (1.20)	.024 (.60)	.010 (.25)	.014 (.35)	.026 (.65)	.008 (.20)	.002 (.05)	.106 (2.70)	.049 (1.25)	.026 (.65)	.031 (.80)

CASE #.	Q	R	WT, GRAM
MC1630-1	.012 (.30)	.012 (.30)	.006

Dimensions are in inches (mm). Tolerances: 2 Pl. $\pm .01$; 3 Pl. $\pm .005$

Notes:

- Case material: Plastic.
- Termination finish:
For RoHS Case Styles: Tin-Silver over Nickel plated or Matte-Tin plated (See Data sheet).
All models, (+) suffix.
- Lead #1 identifier shall be located in the cross-hatched area shown.
Identifier may be either a molded or marked feature.



P.O. Box 350166, Brooklyn, New York 11235-0003 (718) 934-4500 Fax (718) 332-4661 For detailed performance specs & shopping online see Mini-Circuits web site



The Design Engineers Search Engine Provides ACTUAL Data Instantly From MINI-CIRCUITS At: www.minicircuits.com

RF/IF MICROWAVE COMPONENTS

Tape & Reel Packaging TR-F66

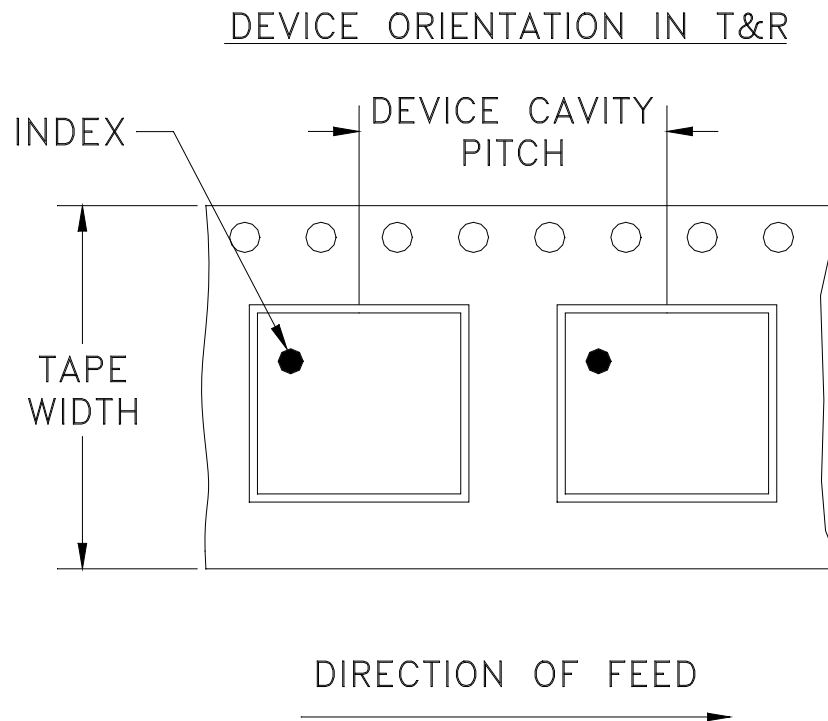

Tape Width, mm	Device Cavity Pitch, mm	Reel Size, inches	Devices per Reel see note	
8	4	7	Small quantity standard	20
				50
				100
				200
				500
		7	Standard	1000, 2000, 3000

Note: Please consult individual model data sheet to determine device per reel availability.

Mini-Circuits carrier tape materials provide protection from ESD (Electro-Static Discharge) during handling and transportation. Tapes are static dissipative and comply with industry standards EIA-481/EIA-541.

Go to: www.minicircuits.com/pages/pdfs/tape.pdf

Mini-Circuits®

INTERNET <http://www.minicircuits.com>

P.O. Box 350166, Brooklyn, New York 11235-0003 (718) 934-4500 Fax (718) 332-4661

Distribution Centers NORTH AMERICA 800-654-7949 • 417-335-5935 • Fax 417-335-5945 • EUROPE 44-1252-832600 • Fax 44-1252-837010

Mini-Circuits ISO 9001 & ISO 14001 Certified

THIRD ANGLE PROJECTION

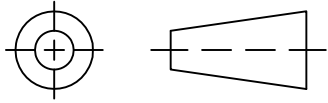

REVISIONS

REV	ECN No.	DESCRIPTION	DATE	DR	AUTH
OR	ECO-001053	NEW RELEASE	12/18/19	GF	IL

SUGGESTED MOUNTING CONFIGURATION
FOR MC1630-1 CASE STYLE,

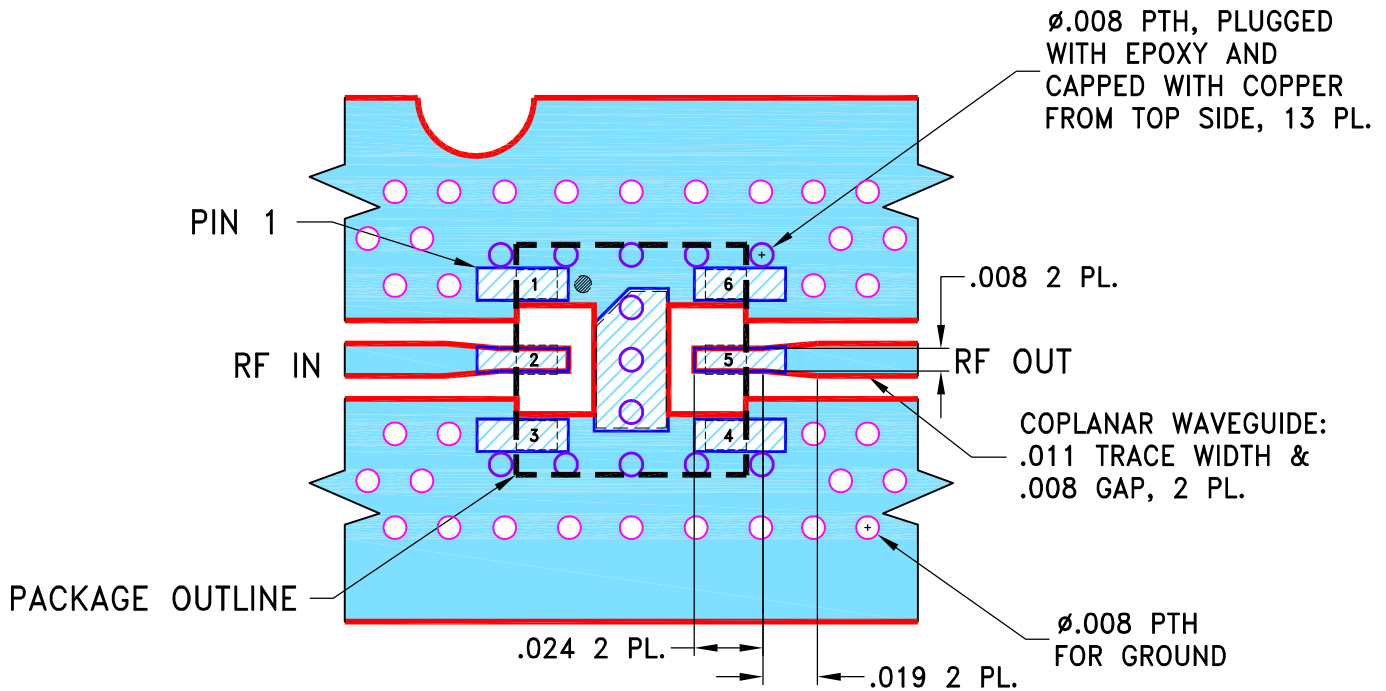

NOTES:

1. TRACE WIDTH & GAP PARAMETERS ARE SHOWN FOR ROGERS R04350B WITH DIELECTRIC THICKNESS $.0066 \pm .001$. COPPER: 1/2 OZ. EACH SIDE. FOR OTHER MATERIALS TRACE WIDTH & GAP MAY NEED TO BE MODIFIED.
2. UNIT FOOT PRINT IS OPTIMIZED FOR PERFORMANCE AND IS DIFFERENT FROM CASE STYLE MC1630-1 RECOMMENDATIONS.
3. BOTTOM SIDE OF THE PCB IS CONTINUOUS GROUND PLANE.



DENOTES PCB COPPER LAYOUT WITH SMOBC (SOLDER MASK OVER BARE COPPER).



DENOTES COPPER LAND PATTERN FREE OF SOLDER MASK.

UNLESS OTHERWISE SPECIFIED	INITIALS	DATE
DIMENSIONS ARE IN INCHES TOLERANCES ON: 2 PL DECIMALS ± 3 PL DECIMALS ± .005 ANGLES ± FRACTIONS ±	DRAWN	GF 12/16/19
	CHECKED	IL 12/18/19
	APPROVED	IL 12/18/19



Mini-Circuits®

13 Neptune Avenue
Brooklyn NY 11235

PL, MC1630-1, TB-EQY-X-453+
TB-EQY-X-453C+

SIZE A	CODE IDENT 15542	DRAWING NO: 98-PL-663	REV: OR
FILE: 98PL663	SCALE: 15:1	SHEET: 1 OF 1	

Mini-Circuits®
THIS DOCUMENT AND ITS CONTENTS ARE THE PROPERTY OF MINI-CIRCUITS. EXCEPT FOR USE EXPRESSLY GRANTED, IN WRITING, TO ITS VENDORS, VENDEE AND THE UNITED STATES GOVERNMENT, MINI-CIRCUITS RESERVES ALL PROPRIETARY DESIGN, USE, MANUFACTURING AND REPRODUCTION RIGHTS THERETO. THESE CONTENTS SHALL NOT BE USED, DUPLICATED OR DISCLOSED TO ANY OUTSIDE PARTY, IN WHOLE OR IN PART, WITHOUT WRITTEN PERMISSION OF MINI-CIRCUITS.

Evaluation Board and Circuit

SEE DETAIL "A"

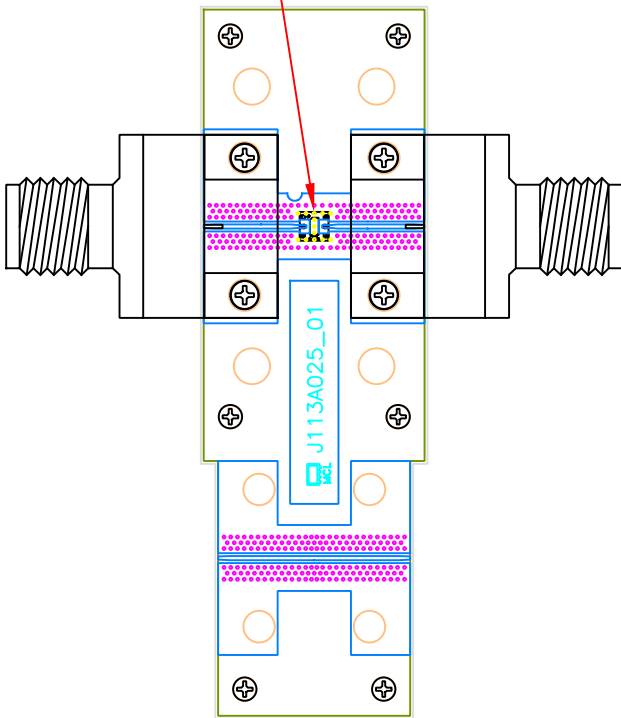

INDEX — DUT

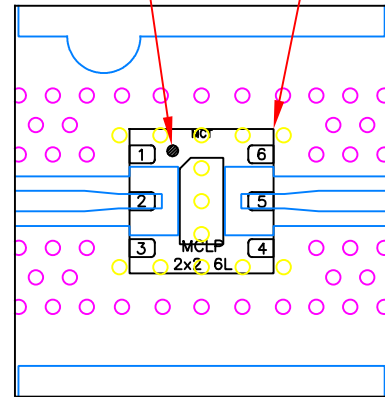

DETAIL "A"
(SCALE 5:1)

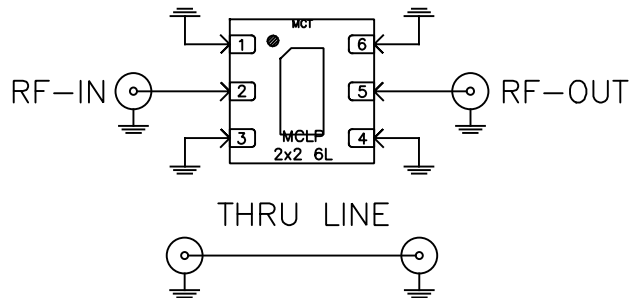

SCHEMATIC DIAGRAM
(SCALE 5:1)

Function	Pad
RF-IN	2
RF-OUT	5
GND	1,3,4,6

Notes:

1. 2.4mm Female Connectors.
2. PCB Material: Roger R04350B or equivalent,
Dielectric constant=3.5, Thickness=0.0066 inch

 Mini-Circuits®

All Mini-Circuits products are manufactured under exacting quality assurance and control standards, and are capable of meeting published specifications after being subjected to any or all of the following physical and environmental test.

Specification	Test/Inspection Condition	Reference/Spec
Operating Temperature	-40° to 85° C or -45° to 85° C or -55° to 105° C or -40° to 105° C or -40° to 95° C Ambient Environment	Individual Model Data Sheet
Storage Temperature	-55° to 100° C or -65° to 150° Ambient Environment	Individual Model Data Sheet
HTOL	1000 hours at 125°C	MIL-STD-883, Method 1005, Condition B
Thermal Shock	-55° to 100°C, 100 cycles	MIL-STD-202, Method 107, Condition A-3, except +100°C
Mechanical Shock	1.5Kg, 0.5 ms, 5 shock pulses, Y1 direction only	MIL-STD-883, Method 2002, Condition B, except Y1 direction only
Vibration (Variable Frequency)	50g peak	MIL-STD-883, Method 2007, Condition B
Autoclave	15 psig, 100% RH, 121°C, 96 hours	JESD22-A102, Condition C
HAST	130°C, 85% RH, 96 hours	JESD22-A110
Solderability	10X Magnification	J-STD-002, Para 4.2.5, Test S, 95% Coverage
Solder Reflow Heat	Sn-Pb Eutetic Process: 240°C peak Pb-Free Process: 260°C peak	J-STD-020, Table 4-1, 4-2 and 5-2; Figure 5-1
Moisture Sensitivity: Level 1	Bake at 125°C for 24 hours Soak at 85°C/85% RH for 168 hours, Reflow 3 cycles at 260°C peak	J-STD-020

All Mini-Circuits products are manufactured under exacting quality assurance and control standards, and are capable of meeting published specifications after being subjected to any or all of the following physical and environmental test.

Specification	Test/Inspection Condition	Reference/Spec
Marking Resistance to Solvents	Isopropyl alcohol + mineral spirits at 25°C; terpene defluxer at 25°C; distilled water + proylene glycol monomethyl ether + monoethanolamine at 63°C to 70°C	MIL-STD-202, Method 215