

Surface Mount

Diplexer

DPLX-6588A0+

75Ω DC to 1000 MHz
(DC-65, 88-1000 MHz)

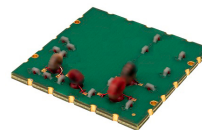

CASE STYLE: NU1620

The Big Deal

- Low insertion loss
- High rejection, 50dB typ.
- 75Ω Impedance
- Used in DOCSIS 3.0 standard

Product Overview

DPLX-6588A0+ has lowpass port at DC-65 MHz and highpass port at 88-1000 MHz. Good return loss combined with high out of channel rejection makes it a ideal component in cable TV and multiband radio systems.

Key Features

Feature	Advantages
Low passband insertion loss	Low passband insertion loss ensures low signal loss through both the channels.
Good stopband rejection	Co-channel rejection of 50dB ensures unwanted spurious are eliminated.
Good return loss at DC-65 and 88-1000 MHz	This makes signal transmission with very less reflection and well-matched with the adjacent component used in the system.

Notes

- A. Performance and quality attributes and conditions not expressly stated in this specification document are intended to be excluded and do not form a part of this specification document.
B. Electrical specifications and performance data contained in this specification document are based on Mini-Circuit's applicable established test performance criteria and measurement instructions.
C. The parts covered by this specification document are subject to Mini-Circuits standard limited warranty and terms and conditions (collectively, "Standard Terms"); Purchasers of this part are entitled to the rights and benefits contained therein. For a full statement of the Standard Terms and the exclusive rights and remedies thereunder, please visit Mini-Circuits' website at www.minicircuits.com/MCLStore/terms.jsp



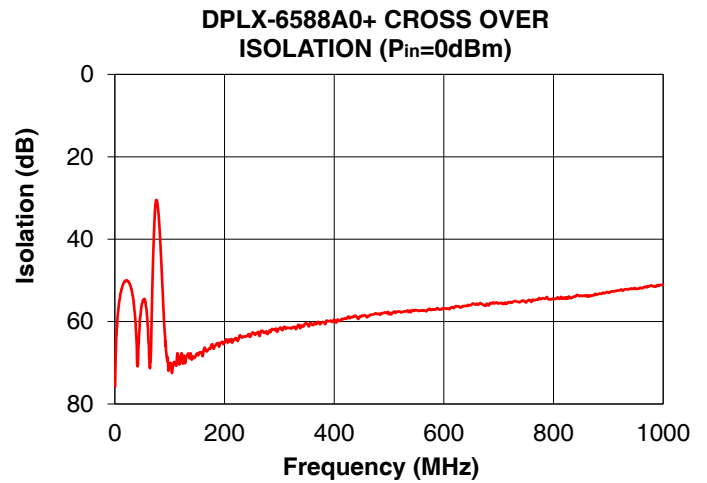
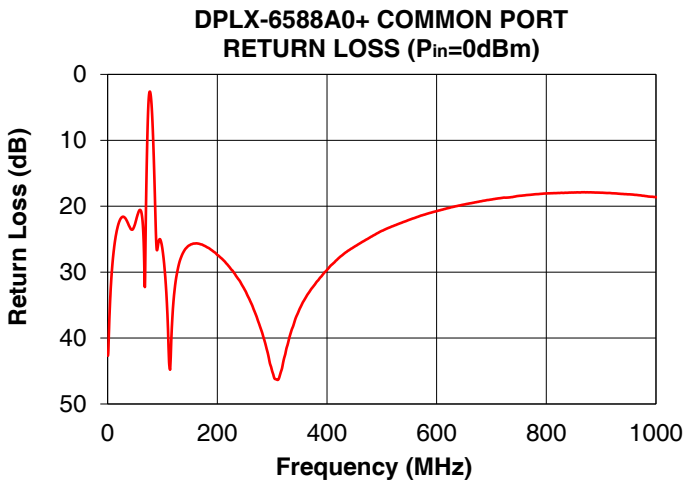
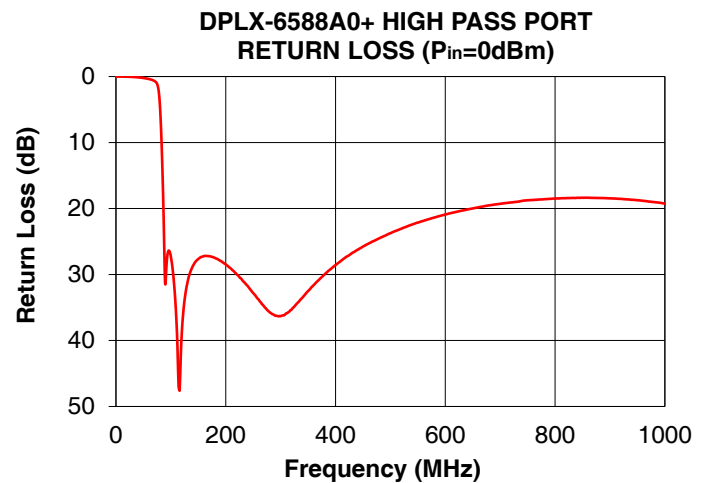
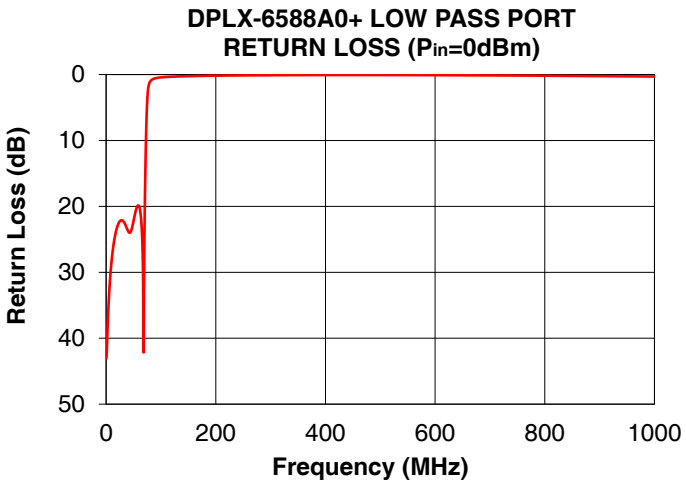
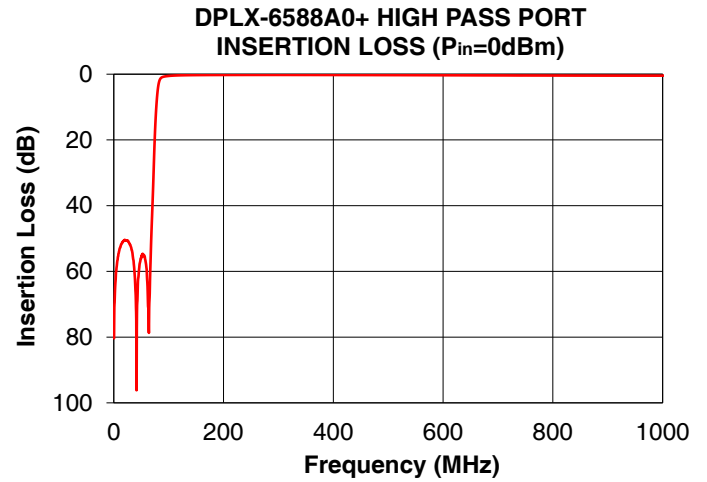
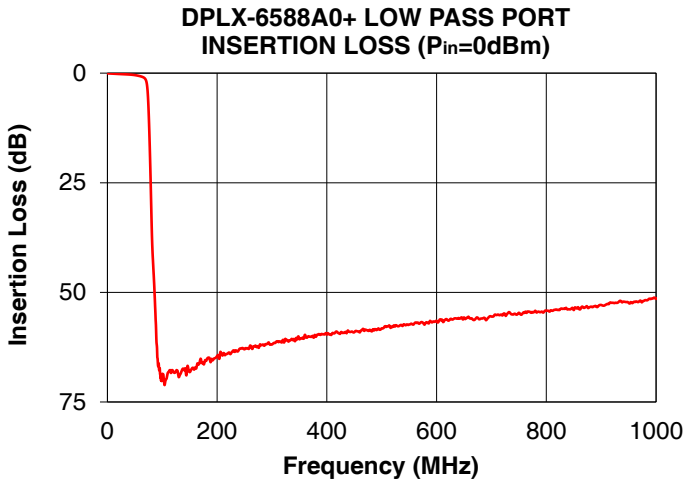

Notes

- A. Performance and quality attributes and conditions not expressly stated in this specification document are intended to be excluded and do not form a part of this specification document.
- B. Electrical specifications and performance data contained in this specification document are based on Mini-Circuit's applicable established test performance criteria and measurement instructions.
- C. The parts covered by this specification document are subject to Mini-Circuits standard limited warranty and terms and conditions (collectively, "Standard Terms"); Purchasers of this part are entitled to the rights and benefits contained therein. For a full statement of the Standard Terms and the exclusive rights and remedies thereunder, please visit Mini-Circuits' website at www.minicircuits.com/MCLStore/terms.jsp



Typical Performance Data

FREQUENCY (MHz)	INSERTION LOSS (dB)		Cross over isolation (dB) (between LPF and HPF)	RETURN LOSS (dB)		
	Lowpass port	Highpass port		Common port	Lowpass port	Highpass port
1.0	0.04	71.03	71.48	42.33	42.25	0.00
3.0	0.07	63.36	63.30	37.27	37.73	0.00
5.0	0.08	58.92	58.74	33.46	33.98	0.00
10.0	0.11	53.68	53.21	27.59	28.22	0.00
20.0	0.18	50.37	50.13	22.60	23.16	0.02
30.0	0.24	51.84	52.17	21.65	22.16	0.05
40.0	0.31	67.38	66.29	23.12	23.75	0.12
50.0	0.44	56.02	55.51	22.67	22.19	0.22
60.0	0.70	59.55	61.10	20.61	19.99	0.37
65.0	0.91	68.75	69.82	24.07	23.49	0.49
70.5	1.68	39.87	41.59	17.05	20.04	0.69
71.0	1.89	37.59	39.65	14.77	17.21	0.72
71.5	2.16	35.28	37.86	12.68	14.70	0.75
72.0	2.51	32.79	36.23	10.77	12.44	0.78
73.0	3.62	27.55	33.45	7.49	8.60	0.86
73.5	4.43	24.97	32.41	6.16	7.04	0.91
74.0	5.45	22.48	31.59	5.06	5.71	0.97
75.0	8.15	18.04	30.61	3.52	3.77	1.13
76.0	11.63	14.35	30.48	2.77	2.59	1.39
77.0	15.75	11.30	30.89	2.60	1.91	1.77
78.0	20.38	8.74	31.73	2.86	1.51	2.34
78.5	22.88	7.64	32.29	3.14	1.37	2.72
79.0	25.48	6.64	32.93	3.51	1.26	3.17
79.5	28.18	5.74	33.66	3.98	1.17	3.71
80.0	30.89	4.95	34.46	4.55	1.09	4.33
81.0	36.07	3.66	36.40	5.98	0.97	5.85
82.0	39.93	2.73	38.62	7.80	0.88	7.72
83.0	42.58	2.08	41.02	9.96	0.80	9.94
84.0	45.01	1.64	43.77	12.42	0.74	12.48
85.0	47.41	1.35	46.48	15.16	0.70	15.33
86.0	50.24	1.16	49.39	18.12	0.66	18.53
87.0	53.18	1.02	52.28	21.23	0.62	22.17
88.0	56.33	0.93	55.14	24.16	0.59	26.26
89.0	59.50	0.86	57.96	26.14	0.57	30.19
90.0	61.95	0.80	60.58	26.68	0.55	31.51
100.0	68.58	0.53	70.90	26.59	0.42	27.30
120.0	68.04	0.35	68.49	34.46	0.32	38.72
150.0	68.20	0.28	67.72	25.89	0.24	27.65
200.0	64.53	0.24	65.23	27.39	0.16	28.47
220.0	63.86	0.23	63.99	29.02	0.15	29.98
250.0	62.99	0.23	62.77	32.68	0.12	32.82
280.0	62.05	0.23	62.69	38.76	0.10	35.72
300.0	61.90	0.23	61.71	45.02	0.09	36.31
350.0	60.70	0.23	60.51	35.60	0.08	32.50
400.0	59.63	0.25	59.47	29.67	0.07	28.57
450.0	59.10	0.26	58.54	26.15	0.06	25.77
500.0	58.18	0.28	58.24	23.74	0.07	23.75
550.0	57.34	0.30	57.27	22.06	0.07	22.13
600.0	56.48	0.32	56.77	20.74	0.08	20.89
650.0	55.72	0.35	56.00	19.74	0.10	19.99
700.0	55.52	0.37	55.56	18.98	0.12	19.29
720.0	55.28	0.38	55.38	18.73	0.13	19.08
740.0	55.03	0.39	55.14	18.57	0.14	18.84
750.0	54.65	0.39	55.40	18.43	0.14	18.75
770.0	54.41	0.40	54.62	18.27	0.15	18.64
800.0	54.20	0.41	54.46	18.06	0.17	18.50
850.0	54.04	0.42	53.67	17.92	0.20	18.37
900.0	52.87	0.43	52.96	17.95	0.23	18.46
950.0	52.38	0.44	52.11	18.19	0.26	18.73
1000.0	51.48	0.44	51.07	18.62	0.29	19.26

Typical Performance Curves

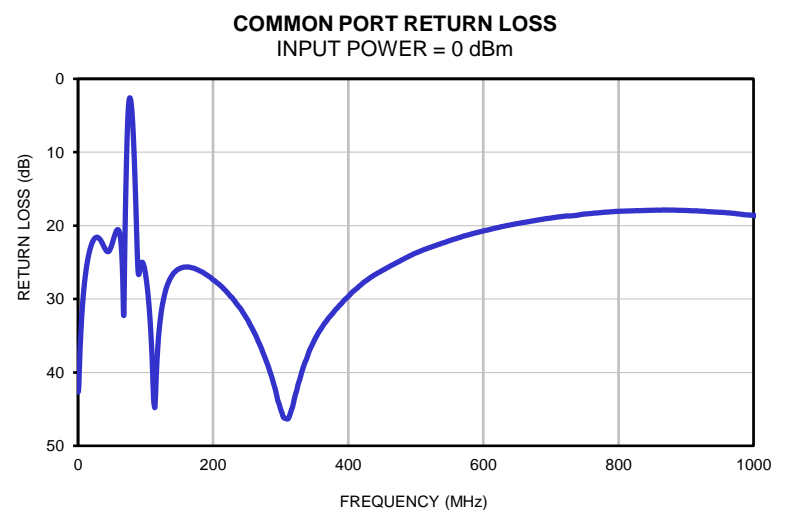
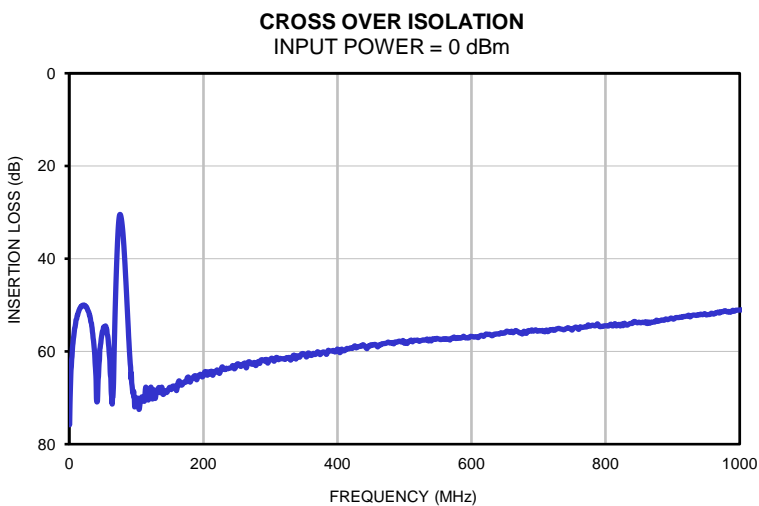
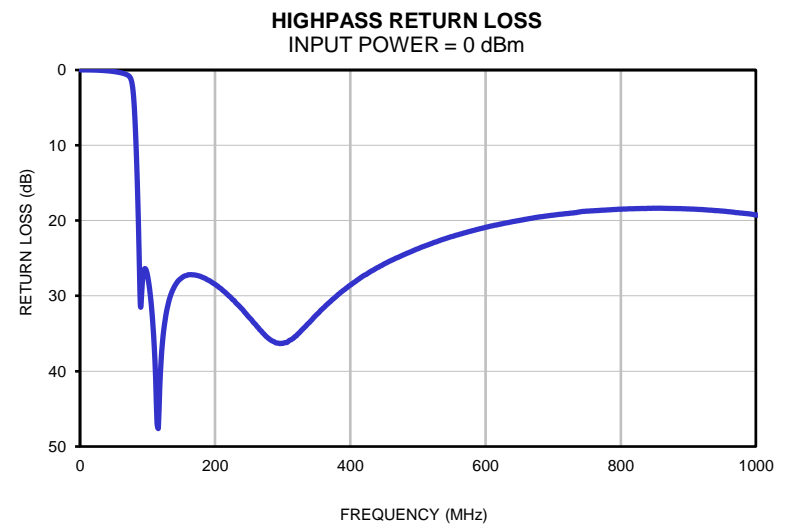
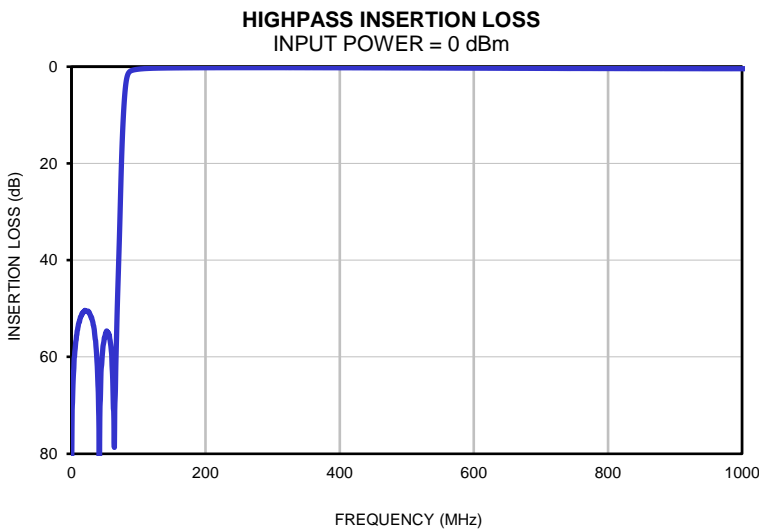
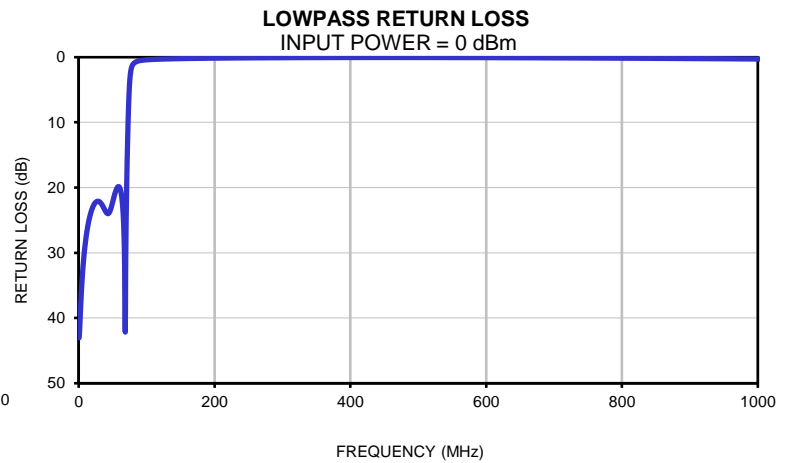
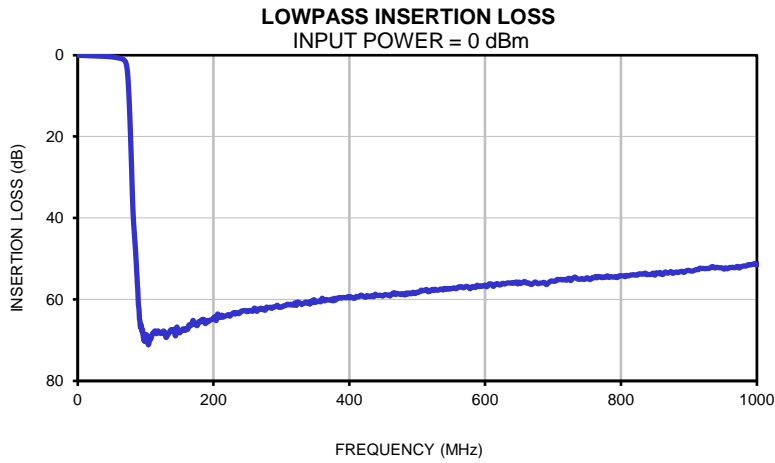

Outline Dimensions

NU1620

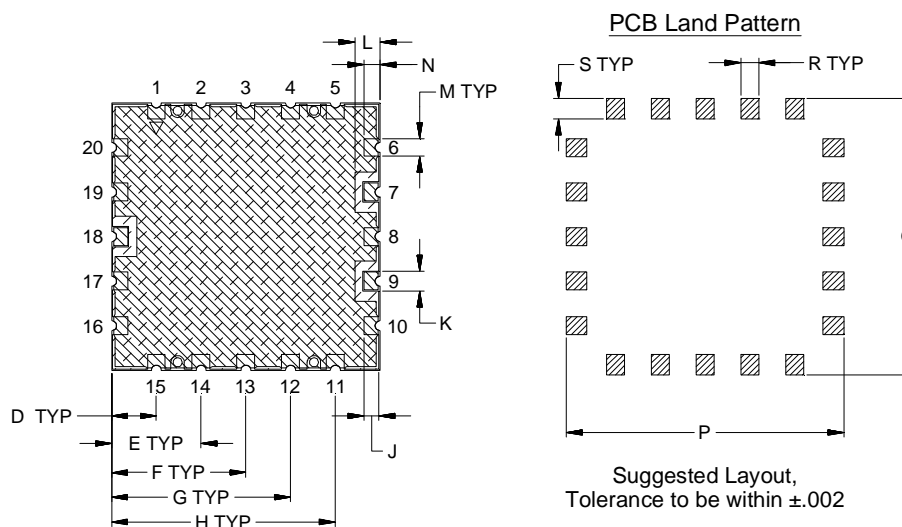
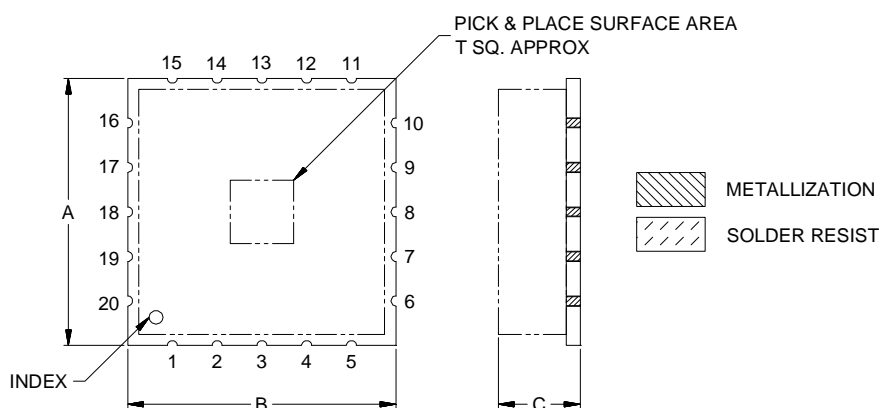

CASE#	A	B	C		D	E	F	G	H	J	K	L	M
			Max	Min									
NU1620	1.181 (30.00)	1.181 (30.00)	.280 (7.11)	.205 (5.21)	.197 (5.00)	.394 (10.00)	.591 (15.00)	.787 (20.00)	.984 (25.00)	.066 (1.68)	.089 (2.26)	.111 (2.82)	.079 (2.01)

CASE#	N	P	Q	R	S	T	WT.GRAMS
NU1620	.071 (1.80)	1.221 (31.01)	1.221 (31.01)	.079 (2.01)	.091 (2.31)	.280 (7.11)	3.6

Dimensions are in inches (mm). Tolerances: 2Pl. ± .03; 3Pl. ± .015

Notes:

1. Base: Printed wiring laminate.
2. Termination finish:
 - For RoHS Case Styles: 3-5 μ inch Gold over 120-240 μ inch Nickel plate.
 - For RoHS-5 Case Styles: Tin-Lead plate.



P.O. Box 350166, Brooklyn, New York 11235-0003 (718) 934-4500 Fax (718) 332-4661 For detailed performance specs & shopping online see Mini-Circuits web site



The Design Engineers Search Engine Provides ACTUAL Data Instantly From MINI-CIRCUITS At: www.minicircuits.com

RF/IF MICROWAVE COMPONENTS

Tape & Reel Packaging TR-F80

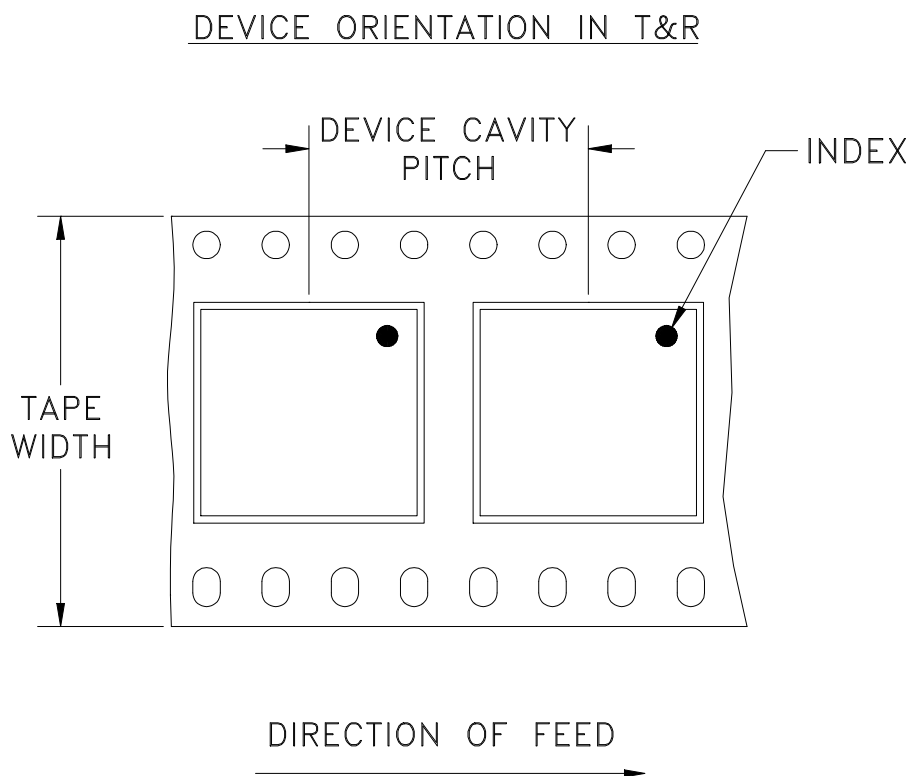

Tape Width, mm	Device Cavity Pitch, mm	Reel Size, inches	Devices per Reel
44	40	13	100

Mini-Circuits carrier tape materials provide protection from ESD (Electro-Static Discharge) during handling and transportation. Tapes are static dissipative and comply with industry standards EIA-481/EIA-541.

Go to: www.minicircuits.com/pages/pdfs/tape.pdf



INTERNET <http://www.minicircuits.com>

P.O. Box 350166, Brooklyn, New York 11235-0003 (718) 934-4500 Fax (718) 332-4661

Distribution Centers NORTH AMERICA 800-654-7949 • 417-335-5935 • Fax 417-335-5945 • EUROPE 44-1252-832600 • Fax 44-1252-837010

Mini-Circuits ISO 9001 & ISO 14001 Certified

THIRD ANGLE PROJECTION

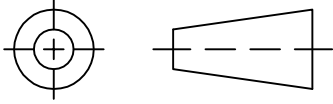

REVISIONS

REV	ECN No.	DESCRIPTION	DATE	DR	AUTH
OR	M147697	NEW RELEASE	SEP 14	DDR	MD

SUGGESTED MOUNTING CONFIGURATION FOR NU1620, NV1998, NZ2001, PA2002 CASE STYLE "20DP01" PIN CODE

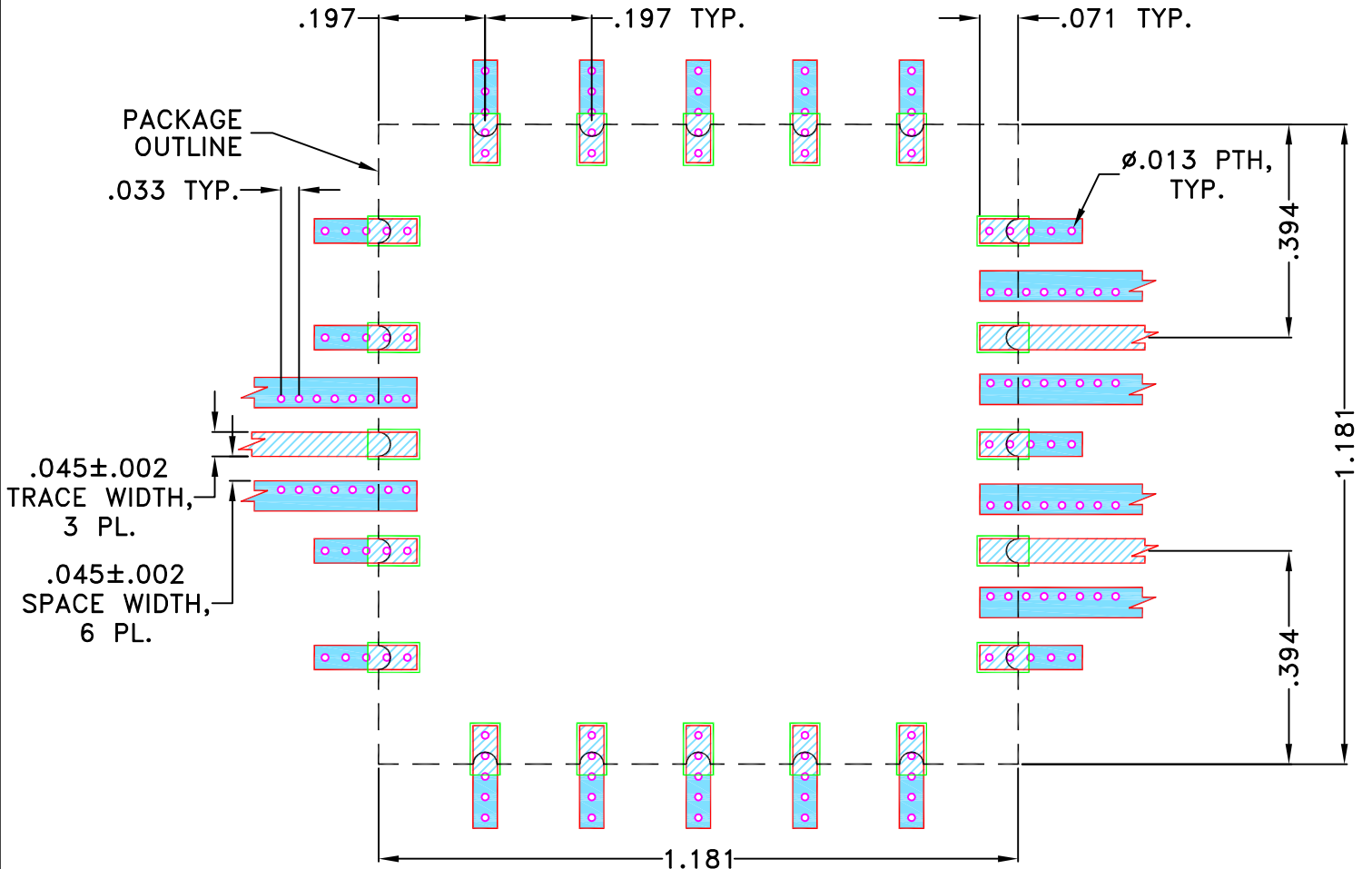

NOTES:

- TRACE WIDTH IS SHOWN FOR OAK-602 WITH DIELECTRIC THICKNESS .031"±.002". COPPER: 1/2 OZ. EACH SIDE. FOR OTHER MATERIALS TRACE WIDTH MAY NEED TO BE MODIFIED.
- BOTTOM SIDE OF THE PCB IS CONTINUOUS GROUND PLANE.



DENOTES PCB COPPER LAYOUT WITH SMOBC (SOLDER MASK OVER BARE COPPER)



DENOTES COPPER LAND PATTERN FREE OF SOLDERMASK

UNLESS OTHERWISE SPECIFIED	INITIALS	DATE
DIMENSIONS ARE IN INCHES	DRAWN DDR	09 SEP 14
TOLERANCES ON:	CHECKED MD	09 SEP 14
2 PL DECIMALS ±	APPROVED KR	09 SEP 14
3 PL DECIMALS ± .005"		
ANGLES ±		
FRACTIONS ±		



Mini-Circuits®

13 Neptune Avenue
Brooklyn NY 11235

PL, 20DP01, NU1620, NV1998, NZ2001, PA2002, TB-786+, 75 OHM

SIZE A	CODE IDENT 15542	DRAWING NO: 98-PL-435	REV: OR
FILE: 98PL435	SCALE: 3:1	SHEET: 1 OF 1	

Mini-Circuits®
THIS DOCUMENT AND ITS CONTENTS ARE THE PROPERTY OF MINI-CIRCUITS. EXCEPT FOR USE EXPRESSLY GRANTED, IN WRITING, TO ITS VENDORS, VENDEE AND THE UNITED STATES GOVERNMENT, MINI-CIRCUITS RESERVES ALL PROPRIETARY DESIGN, USE, MANUFACTURING AND REPRODUCTION RIGHTS THERETO. THESE CONTENTS SHALL NOT BE USED, DUPLICATED OR DISCLOSED TO ANY OUTSIDE PARTY, IN WHOLE OR IN PART, WITHOUT WRITTEN PERMISSION OF MINI-CIRCUITS.

Evaluation Board and Circuit

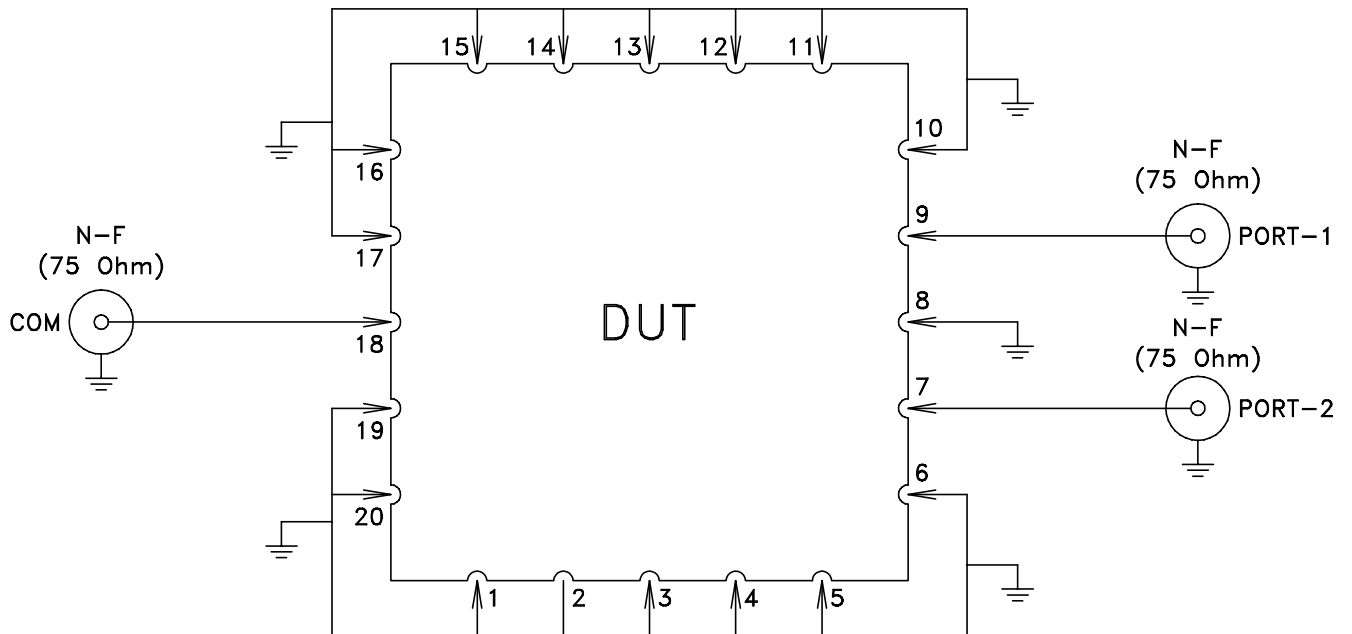
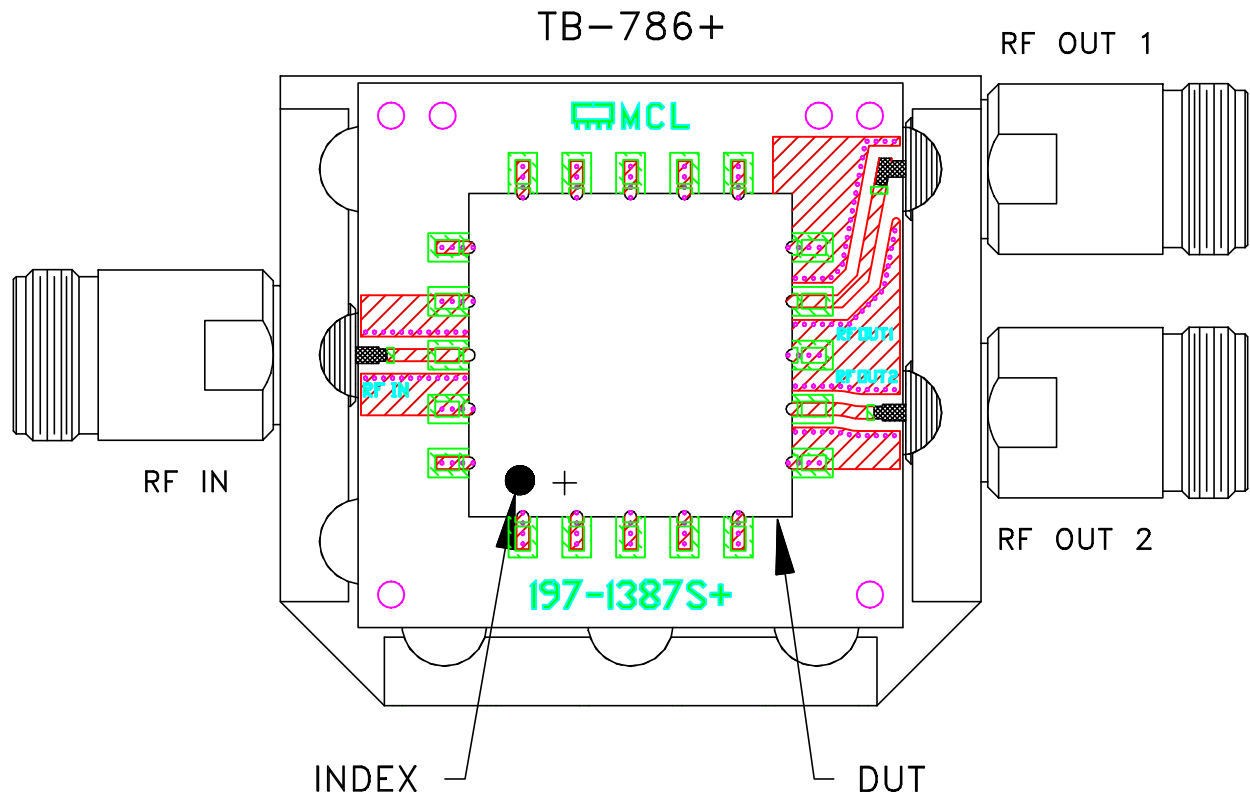

Schematic Diagram

Notes:

1. 75 Ohm N Female connectors.
2. PCB Material: OAK-602 OR Equivalent
Dielectric Constant=2.50±.04, Thickness=.031 inch.

 **Mini-Circuits®**

All Mini-Circuits products are manufactured under exacting quality assurance and control standards, and are capable of meeting published specifications after being subjected to any or all of the following physical and environmental test.

Specification	Test/Inspection Condition	Reference/Spec
Operating Temperature	-55° to 85°C Ambient Environment	Individual Model Data Sheet
Storage Temperature	-55° to 100° C Ambient Environment	Individual Model Data Sheet
HAST	130°C, 85% RH, 96 hours	JESD22-A110
Humidity	90 to 95% RH, 240 hours, 50°C	MIL-STD-202, Method 103, Condition A, Except 50°C and end-point electrical test done within 12 hours
Thermal Shock	-55° to 100°C, 100 cycles	MIL-STD-202, Method 107, Condition A-3, except +100°C
Solder Reflow Heat	Sn-Pb Eutectic Process: 225°C peak Pb-Free Process, 245°C peak	J-STD-020, Table 4-1, 4-2 and 5-2, Figure 5-1
Solderability	10X Magnification	J-STD-002, Para 4.2.5, Test S, 95% Coverage
Vibration (High Frequency)	20g peak, 20-2000 Hz, 4 times in each of three axes (total 12)	MIL-STD-883, Method 2007.3, Condition A
Mechanical Shock	50g, 11 ms, 1/2-sine, 18 shocks: 3 each direction, each of 3 axes	MIL-STD-202, Method 213, Condition A
Marking Resistance to Solvents	Isopropyl alcohol + mineral spirits at 25°C; terpene defluxer at 25°C; distilled water + proylene glycol monomethyl ether + monoethanolamine at 63°C to 70°C	MIL-STD-202, Method 215