

top hat[®]

Surface Mount Directional Coupler

DBTC-6-4-75LX+

75Ω, 6dB coupling, 5 to 1250 MHz

Features

- very flat coupling
- very broadband, multi octave
- temperature stable, LTCC base
- all welded construction
- leads attached for better solderability
- micro miniature coupler
- aqueous washable
- protected by US Patents 6,140,887 & 6,784,521



Generic photo used for illustration purposes only

CASE STYLE: AT1642

+RoHS Compliant

The +Suffix identifies RoHS Compliance. See our web site for RoHS Compliance methodologies and qualifications

Available Tape and Reel at no extra cost

Reel Size	Devices/Reel
7"	20, 50, 100, 200, 500
13"	1000, 2000

Applications

- CATV

Electrical Specifications at 25°C

Parameter	Condition (MHz)	Min.	Typ.	Max.	Unit
Frequency Range		5		1250	MHz
Mainline Loss ¹	5-50		2.2	3.1	dB
	50-500		2.2	2.6	
	500-1000		2.3	2.8	
	1000-1250		2.3	2.9	
Nominal Coupling	5-1250		6.8±0.3		dB
Coupling Flatness(±)	5-1250			±0.8	dB
Directivity	5-50	13	15		dB
	50-500	13	17		
	500-1000	10	16		
	1000-1250	7	12		
VSWR ²	5-1000		1.4		dB
Input Power	5-50			0.5	W
	50-500			1.0	
	500-1000			1.0	
	1000-1250			1.0	

1. Includes theoretical coupled power loss of 1.02 dB at 6 dB coupling.

2. For coupled port VSWR above 500 MHz, 1.6:1 typ.

Maximum Ratings

Parameter	Ratings
Operating Temperature	-40°C to 85°C
Storage Temperature	-55°C to 100°C

Permanent damage may occur if any of these limits are exceeded.

Pin Connections

Function	Pin Number
INPUT	3
OUTPUT	4
COUPLED	1
GROUND	2
ISOLATE (DO NOT USE)	6

Product Marking

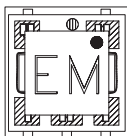

Electrical Schematic

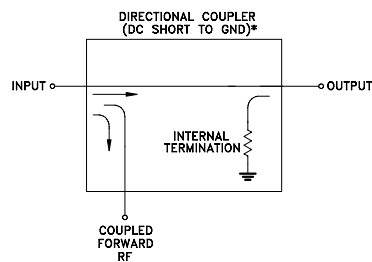

* ELECTRICAL SCHEMATIC IS FOR DIRECTIONAL COUPLER WITH INTERNAL TRANSFORMER(S) THAT ROUTES DC FROM RF PORTS TO GROUND.

REV. A
M151107
ED-10488C/1
DBTC-6-4-75LX+
WP/CP/AM
190827
Page 1 of 2

DBTC-6-4-75LX+

Outline Drawing

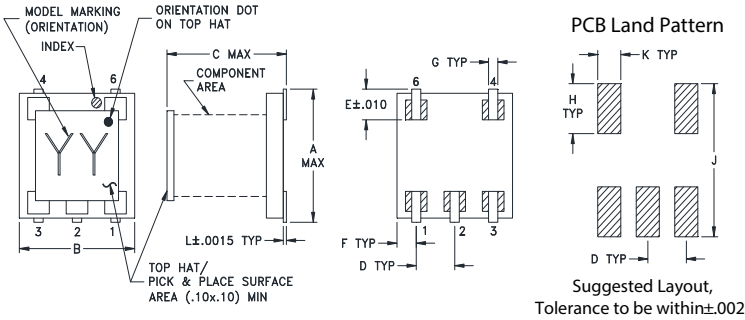

Outline Dimensions (inch/mm)

A	B	C	D	E	F
.166	.150	.155	.050	.037	.025
4.22	3.81	3.94	1.27	0.94	0.64
G	H	J	K	L	wt
.012	.060	.184	.030	.004	grams
0.30	1.52	4.67	0.76	0.10	0.10

Demo Board MCL P/N: TB-279 Suggested PCB Layout (PL-151)

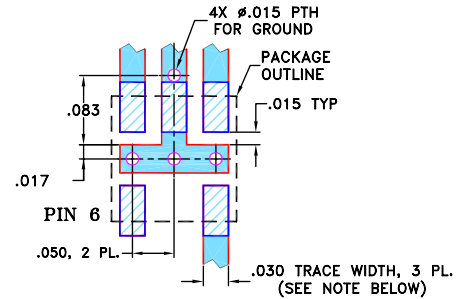

- NOTES: 1. TRACE WIDTH IS SHOWN FOR ROGERS RO4350B WITH DIELECTRIC THICKNESS 0.030 ± 0.002 ”; COPPER: 1/2 OZ. EACH SIDE. FOR OTHER MATERIALS TRACE WIDTH MAY NEED TO BE MODIFIED.
2. BOTTOM SIDE OF THE PCB IS CONTINUOUS GROUND PLANE.

- DENOTES PCB COPPER LAYOUT WITH SMOBC (SOLDER MASK OVER BARE COPPER)
 DENOTES COPPER LAND PATTERN FREE OF SOLDER MASK

Typical Performance Data

Frequency (MHz)	Mainline Loss (dB) In-Out	Coupling (dB) In-Cpl	Directivity (dB)	Return Loss (dB)		
				In	Out	Cpl
5.00	2.41	6.80	14.87	13.53	18.73	13.56
10.00	2.23	6.72	15.49	14.64	24.15	14.72
100.00	2.21	6.78	15.54	15.55	30.88	15.56
400.00	2.24	6.94	16.04	16.09	18.42	14.47
600.00	2.26	7.01	15.94	16.32	16.33	13.60
800.00	2.28	7.16	15.12	17.08	15.48	13.11
1000.00	2.32	7.36	13.45	18.22	15.61	12.36
1050.00	2.34	7.44	12.88	18.62	15.75	12.10
1100.00	2.40	7.51	12.50	18.66	15.58	12.04
1250.00	2.46	7.75	11.03	19.78	14.75	11.49

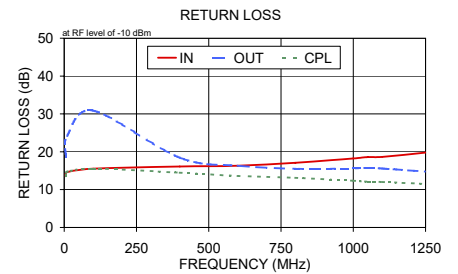
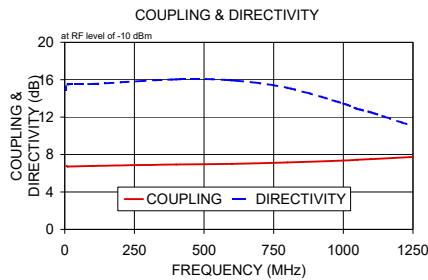
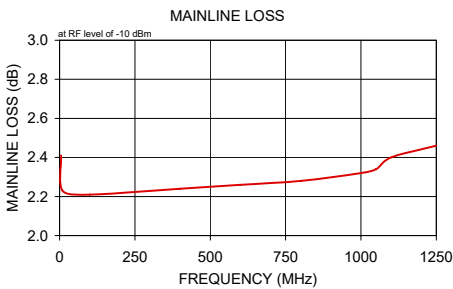

Additional Notes

- A. Performance and quality attributes and conditions not expressly stated in this specification document are intended to be excluded and do not form a part of this specification document.
B. Electrical specifications and performance data contained in this specification document are based on Mini-Circuits' applicable established test performance criteria and measurement instructions.
C. The parts covered by this specification document are subject to Mini-Circuits standard limited warranty and terms and conditions (collectively, "Standard Terms"); Purchasers of this part are entitled to the rights and benefits contained therein. For a full statement of the Standard Terms and the exclusive rights and remedies thereunder, please visit Mini-Circuits' website at www.minicircuits.com/MCLStore/terms.jsp

Directional Coupler

DBTC-6-4-75LX+

Typical Performance Data

TEST CONDITIONS: INPUT POWER =0 dBm @Temperature = +25°C

FREQUENCY (MHz)	INSERTION LOSS (dB)	COUPLING LOSS (dB)	DIRECTIVITY (dB)	RETURN LOSS (dB)		
				IN	OUT	CPL
5.0	2.21	6.64	15.67	14.34	22.00	14.51
10.0	2.16	6.62	15.84	14.75	27.64	14.93
15.0	2.11	6.61	16.01	15.16	33.28	15.36
20.0	2.12	6.61	15.99	15.18	38.17	15.37
25.0	2.12	6.62	15.98	15.21	43.05	15.38
50.0	2.16	6.66	15.89	15.20	42.39	15.33
75.0	2.17	6.68	15.86	15.26	36.01	15.34
100.0	2.18	6.69	15.87	15.34	32.72	15.41
150.0	2.20	6.72	15.96	15.50	28.64	15.44
200.0	2.20	6.75	15.96	15.68	25.96	15.24
250.0	2.20	6.77	15.92	15.86	23.98	15.20
300.0	2.19	6.80	15.95	16.03	22.45	15.30
350.0	2.19	6.82	16.18	16.22	21.23	15.01
400.0	2.19	6.84	16.29	16.43	20.23	14.67
450.0	2.19	6.88	16.12	16.65	19.45	14.77
475.0	2.19	6.89	16.08	16.77	19.12	14.83
500.0	2.19	6.90	16.17	16.91	18.81	14.73
550.0	2.20	6.93	16.37	17.20	18.32	14.32
600.0	2.21	6.96	16.40	17.59	17.94	14.26
650.0	2.22	6.99	16.22	18.05	17.68	14.41
700.0	2.24	7.02	16.06	18.56	17.52	14.21
750.0	2.26	7.04	16.04	19.16	17.45	14.10
800.0	2.26	7.07	15.98	19.84	17.44	14.25
850.0	2.28	7.10	15.60	20.62	17.51	14.13
900.0	2.30	7.14	15.08	21.47	17.64	13.96
950.0	2.32	7.18	14.43	22.39	17.79	14.00
1000.0	2.33	7.23	13.61	23.35	17.98	13.77
1050.0	2.35	7.30	12.60	24.34	18.18	13.43
1100.0	2.36	7.38	11.80	25.21	18.38	13.27
1150.0	2.37	7.47	11.10	25.89	18.61	12.90
1200.0	2.38	7.59	10.19	26.28	18.78	12.43
1250.0	2.40	7.71	9.32	26.23	18.95	12.12
1300.0	2.42	7.82	8.67	25.98	19.13	11.71
1350.0	2.45	7.93	8.06	25.49	19.21	11.19
1400.0	2.48	8.01	7.56	25.08	19.28	10.82
1450.0	2.51	8.11	7.04	24.50	19.31	10.47
1500.0	2.58	8.21	6.69	24.04	19.26	10.00
1600.0	2.78	8.34	6.62	23.48	18.93	9.37
1700.0	3.06	8.50	6.42	23.33	18.37	8.73
1800.0	3.45	8.60	6.85	23.61	17.54	8.26
1900.0	3.79	8.84	6.34	24.33	16.48	7.94
2000.0	4.06	9.11	5.68	25.54	15.30	7.74
2100.0	4.24	9.54	4.39	27.73	14.00	7.72
2200.0	4.29	10.09	2.69	31.77	12.63	7.82
2300.0	4.46	10.48	1.47	42.06	11.63	7.85
2400.0	4.76	10.72	0.67	37.34	10.93	7.93
2500.0	5.46	10.67	0.72	27.56	10.40	7.98
2750.0	8.51	10.76	2.10	18.07	9.20	8.27
3000.0	11.79	12.55	0.45	14.07	8.77	8.21
3250.0	13.02	14.88	4.85	11.77	8.01	8.16
3500.0	15.94	16.35	6.90	10.37	7.16	8.11
3750.0	27.10	18.19	6.03	8.93	6.28	8.07
4000.0	31.38	21.71	8.27	7.86	5.69	7.91



REV. OR
DBTC-6-4-75LX+
5/25/2012
Page 1 of 3

P.O. Box 350166, Brooklyn, New York 11235-0003 (718) 934-4500 • Fax (718) 332-4661 For detailed performance specs & shopping online see Mini-Circuits web site
The Design Engineers Search Engine Provides ACTUAL Data Instantly From MINI-CIRCUITS At: www.minicircuits.com



IF/RF MICROWAVE COMPONENTS

Directional Coupler

DBTC-6-4-75LX+

Typical Performance Data

TEST CONDITIONS: INPUT POWER =0 dBm @Temperature = -40°C

FREQUENCY (MHz)	INSERTION LOSS (dB)	COUPLING LOSS (dB)	DIRECTIVITY (dB)	RETURN LOSS (dB)		
				IN	OUT	CPL
5.0	2.48	6.81	14.87	13.00	17.05	13.13
10.0	2.29	6.74	15.58	14.05	21.11	14.21
15.0	2.10	6.66	16.28	15.10	25.16	15.28
20.0	2.07	6.65	16.38	15.39	27.63	15.56
25.0	2.05	6.64	16.48	15.67	30.10	15.83
50.0	2.02	6.62	16.50	16.49	35.55	16.61
75.0	2.03	6.61	16.49	16.59	33.84	16.71
100.0	2.03	6.62	16.48	16.16	31.22	16.29
150.0	2.03	6.63	16.59	16.24	28.39	16.09
200.0	2.04	6.64	16.57	16.38	27.00	15.93
250.0	2.05	6.65	16.48	15.99	25.49	15.25
300.0	2.05	6.66	16.47	16.29	23.77	15.39
350.0	2.05	6.66	16.65	15.92	22.03	14.66
400.0	2.05	6.67	16.72	16.05	20.59	14.22
450.0	2.05	6.68	16.50	16.09	19.49	14.21
475.0	2.06	6.68	16.40	16.05	19.05	14.14
500.0	2.06	6.69	16.49	16.18	18.62	14.01
550.0	2.06	6.69	16.67	16.45	17.92	13.70
600.0	2.07	6.70	16.72	16.79	17.29	13.59
650.0	2.09	6.71	16.49	17.45	16.79	13.89
700.0	2.10	6.71	16.26	18.15	16.45	13.88
750.0	2.11	6.71	16.16	19.24	16.35	14.05
800.0	2.12	6.71	16.01	20.16	16.43	14.41
850.0	2.12	6.71	15.58	21.94	16.69	14.59
900.0	2.13	6.73	14.94	23.64	17.07	14.52
950.0	2.15	6.76	14.12	25.12	17.41	14.50
1000.0	2.16	6.78	13.27	25.43	17.82	14.10
1050.0	2.16	6.84	12.15	24.23	18.20	13.47
1100.0	2.16	6.91	11.27	22.87	18.60	12.91
1150.0	2.16	6.99	10.54	21.75	19.06	12.02
1200.0	2.16	7.11	9.65	20.84	19.49	11.36
1250.0	2.17	7.24	8.80	19.76	19.85	10.75
1300.0	2.18	7.35	8.13	19.47	20.05	10.08
1350.0	2.19	7.46	7.54	19.31	19.98	9.62
1400.0	2.18	7.55	7.08	19.47	19.75	9.33
1450.0	2.19	7.65	6.60	19.91	19.43	9.07
1500.0	2.23	7.75	6.26	21.11	19.06	8.86
1600.0	2.39	7.86	6.34	24.00	18.21	8.87
1700.0	2.64	7.97	6.28	31.42	17.53	8.98
1800.0	2.98	8.02	6.75	29.91	17.14	8.74
1900.0	3.29	8.16	6.23	22.80	16.84	8.39
2000.0	3.52	8.40	5.35	19.45	16.39	7.40
2100.0	3.64	8.76	3.99	17.52	15.46	6.48
2200.0	3.69	9.35	2.14	16.80	14.12	5.65
2300.0	3.85	9.74	0.94	17.43	12.90	5.18
2400.0	4.14	9.99	0.24	19.10	11.70	5.07
2500.0	4.81	9.96	0.49	23.94	10.52	5.56
2750.0	7.97	10.26	2.04	14.63	8.29	9.07
3000.0	11.35	12.49	1.40	8.18	8.23	8.98
3250.0	12.62	14.85	5.86	7.99	8.90	4.96
3500.0	16.31	16.54	7.36	13.71	9.42	3.71
3750.0	27.01	19.05	6.32	7.07	6.14	5.70
4000.0	26.58	21.70	8.22	1.66	4.17	11.73



REV. OR
DBTC-6-4-75LX+
5/25/2012
Page 2 of 3



Directional Coupler

DBTC-6-4-75LX+

Typical Performance Data

TEST CONDITIONS: INPUT POWER =0 dBm @Temperature = +85°C

FREQUENCY (MHz)	INSERTION LOSS (dB)	COUPLING LOSS (dB)	DIRECTIVITY (dB)	RETURN LOSS (dB)		
				IN	OUT	CPL
5.0	2.35	6.73	15.28	13.87	20.73	13.98
10.0	2.29	6.71	15.46	14.28	25.87	14.39
15.0	2.24	6.70	15.64	14.69	31.00	14.80
20.0	2.25	6.71	15.60	14.62	32.90	14.73
25.0	2.26	6.72	15.56	14.56	34.79	14.65
50.0	2.31	6.76	15.46	14.17	33.63	14.19
75.0	2.34	6.79	15.43	14.21	31.78	14.14
100.0	2.34	6.81	15.47	14.68	30.11	14.56
150.0	2.35	6.85	15.57	15.08	27.49	15.03
200.0	2.34	6.88	15.57	15.05	25.27	14.72
250.0	2.34	6.92	15.57	15.85	23.58	15.27
300.0	2.33	6.95	15.60	16.11	22.36	15.60
350.0	2.31	6.98	15.85	16.44	21.46	15.41
400.0	2.31	7.02	15.95	16.94	20.80	15.35
450.0	2.30	7.06	15.83	17.29	20.28	15.47
475.0	2.30	7.08	15.78	17.47	20.08	15.52
500.0	2.30	7.10	15.88	17.71	19.85	15.46
550.0	2.31	7.15	16.10	17.99	19.56	15.06
600.0	2.31	7.19	16.14	18.25	19.30	14.86
650.0	2.33	7.24	15.99	18.81	19.13	14.77
700.0	2.34	7.28	15.87	19.18	19.00	14.51
750.0	2.36	7.31	15.89	19.34	18.89	14.36
800.0	2.37	7.35	15.84	19.90	18.78	14.30
850.0	2.39	7.40	15.48	20.56	18.70	14.09
900.0	2.41	7.45	15.00	20.87	18.64	13.89
950.0	2.44	7.51	14.38	21.72	18.57	13.86
1000.0	2.46	7.58	13.62	22.94	18.52	13.64
1050.0	2.48	7.65	12.65	24.01	18.48	13.47
1100.0	2.51	7.74	11.89	25.27	18.42	13.46
1150.0	2.53	7.84	11.22	27.67	18.38	13.30
1200.0	2.55	7.96	10.30	30.41	18.36	13.18
1250.0	2.57	8.08	9.45	31.43	18.38	13.06
1300.0	2.61	8.21	8.79	32.83	18.46	12.76
1350.0	2.66	8.31	8.21	31.18	18.52	12.37
1400.0	2.69	8.39	7.69	28.69	18.65	11.92
1450.0	2.73	8.48	7.18	27.18	18.79	11.37
1500.0	2.81	8.59	6.83	25.19	18.99	10.78
1600.0	3.03	8.73	6.71	22.90	19.32	9.82
1700.0	3.32	8.93	6.47	21.60	19.37	8.85
1800.0	3.70	9.05	6.86	21.21	18.60	8.20
1900.0	4.04	9.32	6.36	21.60	16.98	7.86
2000.0	4.30	9.60	5.77	22.83	15.11	7.93
2100.0	4.48	10.06	4.48	24.85	13.34	8.34
2200.0	4.52	10.59	2.86	27.33	11.88	9.02
2300.0	4.68	10.98	1.65	27.84	11.05	9.48
2400.0	4.94	11.22	0.82	26.31	10.73	9.58
2500.0	5.58	11.16	0.79	23.69	10.77	9.20
2750.0	8.37	11.06	2.23	21.15	10.55	8.00
3000.0	11.26	12.46	0.26	18.87	9.20	8.09
3250.0	12.27	14.59	4.14	13.35	7.64	9.69
3500.0	14.52	16.08	6.34	10.50	7.34	10.29
3750.0	23.48	17.26	4.90	9.87	6.87	8.85
4000.0	43.80	20.61	7.07	10.43	5.68	7.56



REV. OR
DBTC-6-4-75LX+
5/25/2012
Page 3 of 3

P.O. Box 350166, Brooklyn, New York 11235-0003 (718) 934-4500 • Fax (718) 332-4661 For detailed performance specs & shopping online see Mini-Circuits web site
The Design Engineers Search Engine Provides ACTUAL Data Instantly From MINI-CIRCUITS At: www.minicircuits.com



IF/RF MICROWAVE COMPONENTS

Directional Coupler

DBTC-6-4-75LX+

Typical Performance Curves

Insertion Loss

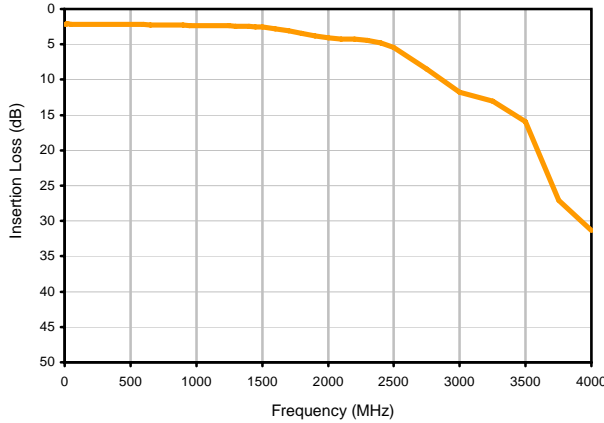

Insertion Loss vs. TEMPERATURE

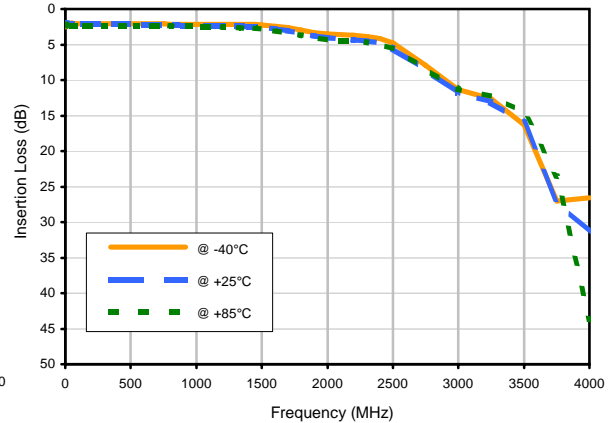

Coupling Loss vs. TEMPERATURE

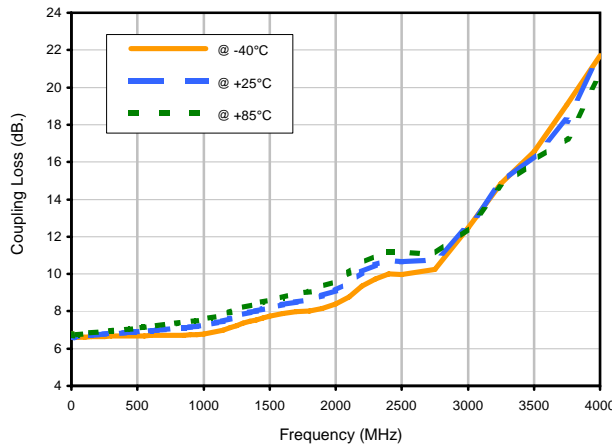

Directivity vs. TEMPERATURE

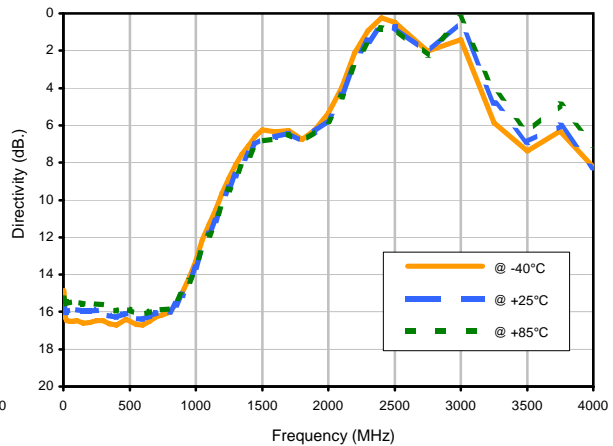

Directional Coupler

DBTC-6-4-75LX+

Typical Performance Curves

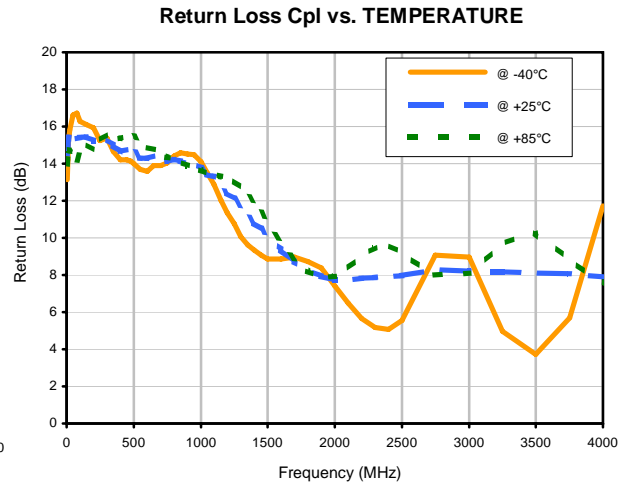
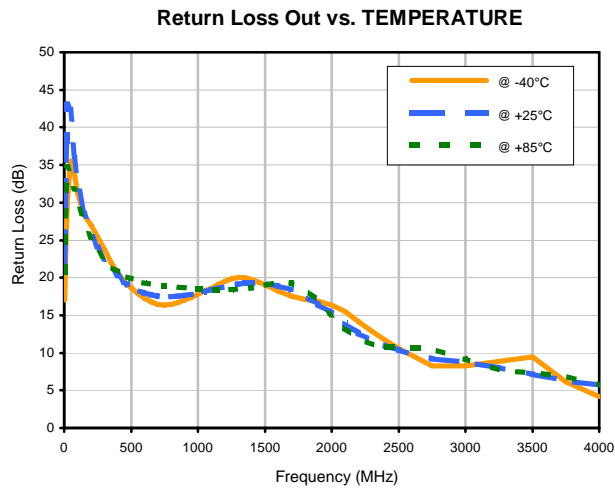
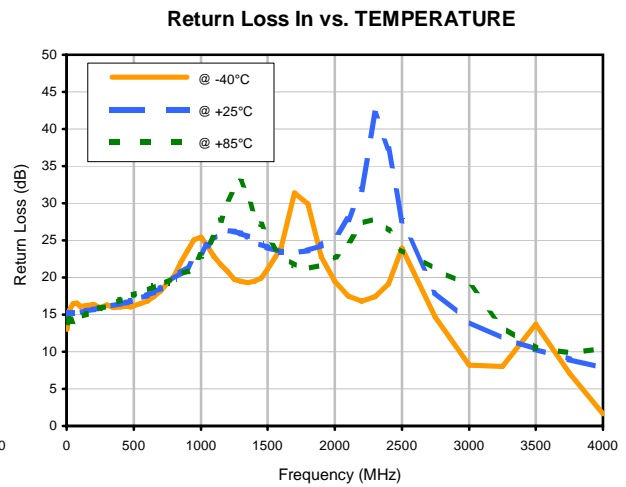
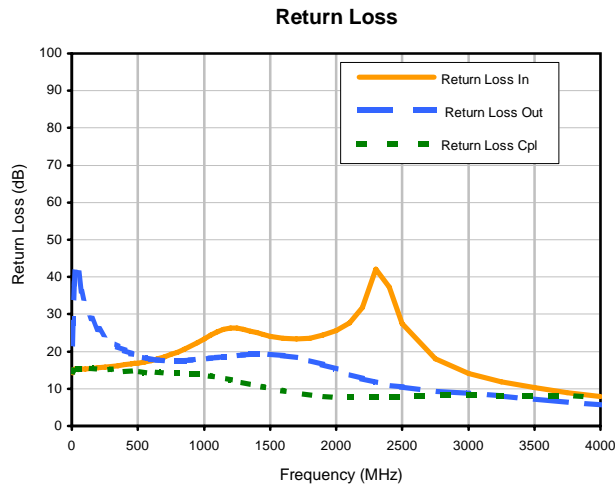

Outline Dimensions

AT1642

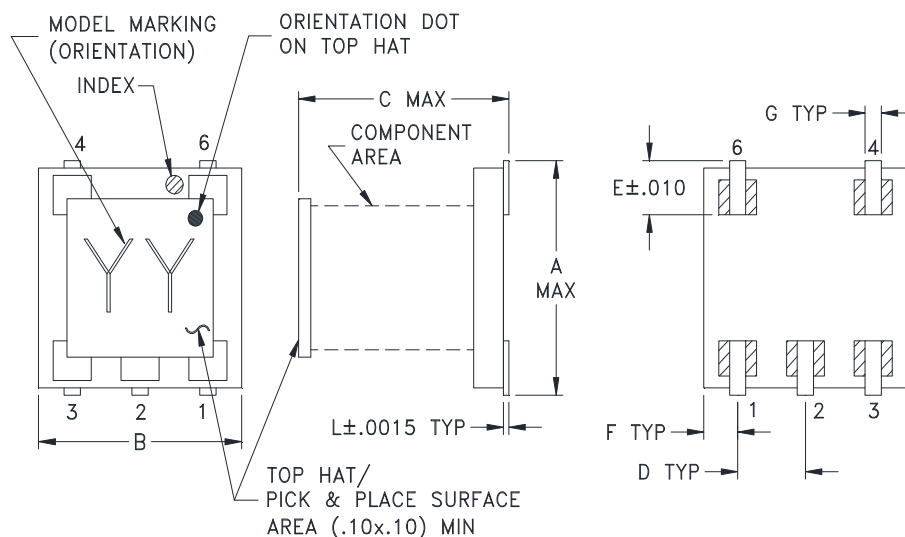

PCB Land Pattern

Suggested Layout,
Tolerance to be within ±.002

CASE #	A	B	C	D	E	F	G	H	J	K	L	WT. GRAMS
AT1642	.166 (4.22)	.150 (3.81)	.155 (3.94)	.050 (1.27)	.037 (0.94)	.025 (.64)	.012 (.30)	.060 (1.52)	.184 (4.67)	.030 (.76)	.004 (0.10)	.10

Dimensions are in inches (mm). Tolerances: 2 Pl. ± .01; 3 Pl. ± .005

Notes:

1. Open style, ceramic base.
2. Termination finish:
For RoHS Case Styles: Tin plate.
3. Top-hat total thickness: .013 inches MAX.
4. Orientation Dot on Top Hat & Marking on the Substrate both refers to Pin #6 of the Unit.



P.O. Box 350186, Brooklyn, New York 11235-0003 (718) 934-4500 Fax (718) 332-4661 For detailed performance specs & shopping online see Mini-Circuits web site



The Design Engineers Search Engine Provides ACTUAL Data Instantly From MINI-CIRCUITS At: www.minicircuits.com

RF/IF MICROWAVE COMPONENTS

Tape & Reel Packaging TR-F76

DEVICE ORIENTATION IN T&R

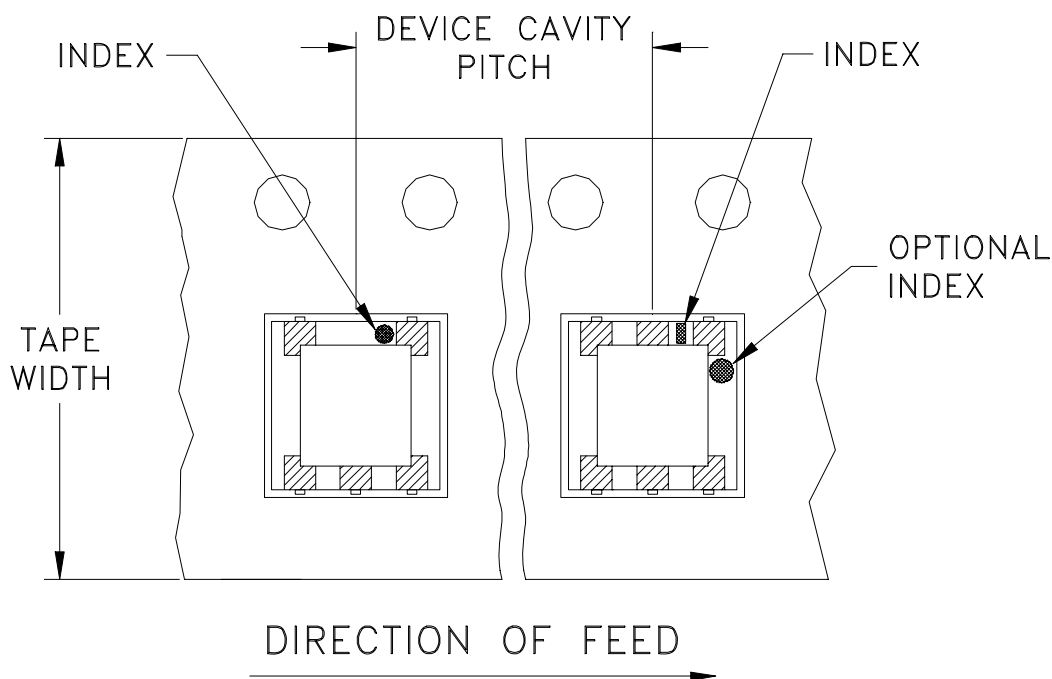

Tape Width, mm	Device Cavity Pitch, mm	Reel Size, inches	Devices per Reel
12	8	7	20
			50
			100
			200
			500
		13	1000
			2000

Note: Please consult individual model data sheet to determine device per reel availability.

Mini-Circuits carrier tape materials provide protection from ESD (Electro-Static Discharge) during handling and transportation. Tapes are static dissipative and comply with industry standards EIA-481/EIA-541.

Go to: www.minicircuits.com/pages/pdfs/tape.pdf

Mini-Circuits[®]

INTERNET <http://www.minicircuits.com>

P.O. Box 350166, Brooklyn, New York 11235-0003 (718) 934-4500 Fax (718) 332-4661

Distribution Centers NORTH AMERICA 800-654-7949 • 417-335-5935 • Fax 417-335-5945 • EUROPE 44-1252-832600 • Fax 44-1252-837010

Mini-Circuits ISO 9001 & ISO 14001 Certified

THIRD ANGLE PROJECTION

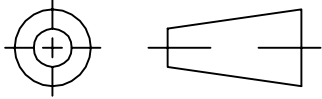

REVISIONS

REV	ECN No.	DESCRIPTION	DATE	DR	AUTH
OR	M90455	NEW RELEASE	01/16/04	AV	WP
A	M102713	ADDED "...WITH SMOBC"	01/17/06	MMG	IL

SUGGESTED MOUNTING CONFIGURATION FOR AT1029 CASE STYLE, "na" PIN CONNECTION

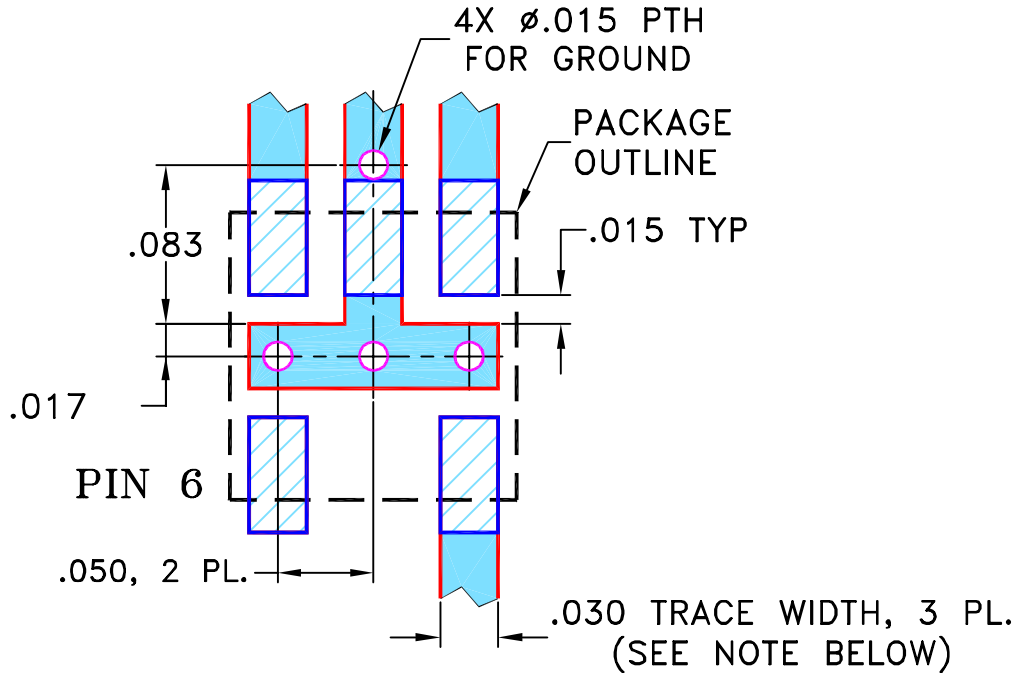

- NOTES: 1. TRACE WIDTH IS SHOWN FOR ROGERS R04350B WITH DIELECTRIC THICKNESS 0.030" ± 0.002"; COPPER: 1/2 OZ. EACH SIDE. FOR OTHER MATERIALS TRACE WIDTH MAY NEED TO BE MODIFIED.
 2. BOTTOM SIDE OF THE PCB IS CONTINUOUS GROUND PLANE.



DENOTES PCB COPPER LAYOUT WITH SMOBC (SOLDER MASK OVER BARE COPPER)



DENOTES COPPER LAND PATTERN FREE OF SOLDER MASK

UNLESS OTHERWISE SPECIFIED	INITIALS	DATE
DIMENSIONS ARE IN INCHES TOLERANCES ON: 2 PL DECIMALS ± 3 PL DECIMALS ± .005 ANGLES ± FRACTIONS ±	DRAWN	AV 01/07/04
	CHECKED	IL 01/16/04
	APPROVED	WP 01/16/04



Mini-Circuits® 13 Neptune Avenue
Brooklyn NY 11235

PL, na, 75, AT1029, DBTC, TB-279

Mini-Circuits®
 THIS DOCUMENT AND ITS CONTENTS ARE THE PROPERTY OF MINI-CIRCUITS. EXCEPT FOR USE EXPRESSLY GRANTED, IN WRITING, TO ITS VENDORS, VENDEE AND THE UNITED STATES GOVERNMENT, MINI-CIRCUITS RESERVES ALL PROPRIETARY DESIGN, USE, MANUFACTURING AND REPRODUCTION RIGHTS THERETO. THESE CONTENTS SHALL NOT BE USED, DUPLICATED OR DISCLOSED TO ANY OUTSIDE PARTY, IN WHOLE OR IN PART, WITHOUT WRITTEN PERMISSION OF MINI-CIRCUITS.

SIZE	CODE IDENT	DRAWING NO:	REV:
A	15542	98-PL-151	A
FILE:	98PL151	SCALE:	10:1
SHEET:	1	OF	1

Evaluation Board and Circuit

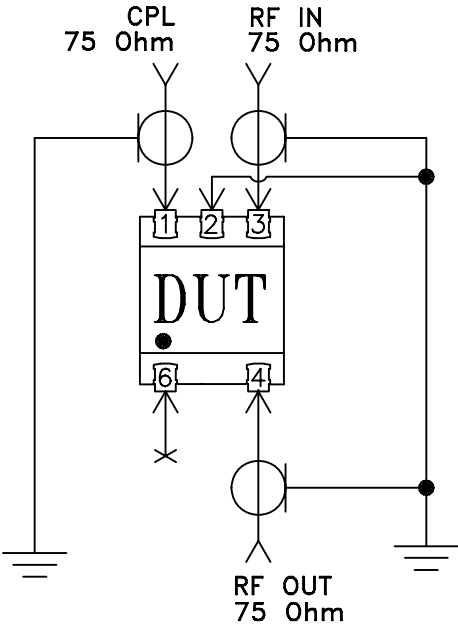
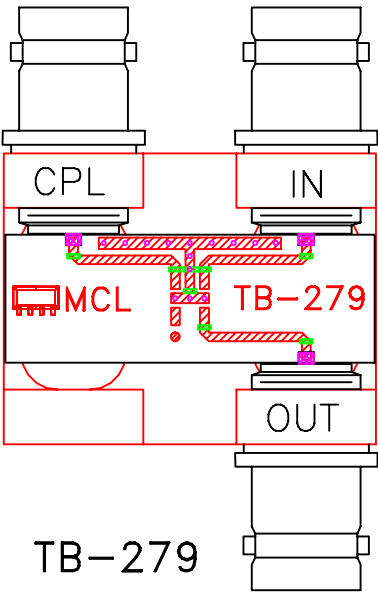

Schematic Diagram

Notes:

- 1. BNC Female connectors.
- 2. PCB Material: Rogers R04350 or equivalent,
Dielectric Constant=3.5, Thickness=.030 inch.

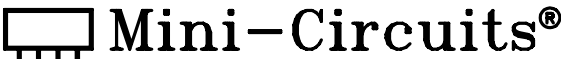



All Mini-Circuits products are manufactured under exacting quality assurance and control standards, and are capable of meeting published specifications after being subjected to any or all of the following physical and environmental test.

Specification	Test/Inspection Condition	Reference/Spec
Operating Temperature	-40° to 85°C Ambient Environment	Individual Model Data Sheet
Storage Temperature	-55° to 100° C Ambient Environment	Individual Model Data Sheet
Humidity	90 to 95% RH, 240 hours, 50°C	MIL-STD-202, Method 103, Condition A, Except 50°C and end-point electrical test done within 12 hours
Thermal Shock	-55° to 100°C, 100 cycles	MIL-STD-202, Method 107, Condition A-3, except +100°C
Solder Reflow Heat	Sn-Pb Eutetic Process: 225°C peak Pb-Free Process 245° - 250°C peak	J-STD-020, Table 4-1, 4-2 and 5-2, Figure 5-1
Solderability	10X Magnification	J-STD-002, 95% Coverage
Vibration (High Frequency)	20g peak, 10-2000 Hz, 12 times in each of three perpendicular directions (total 36)	MIL-STD-202, Method 204, Condition D
Mechanical Shock	50g, 11 ms, 1/2-sine, 18 shocks: 3 each direction, each of 3 axes	MIL-STD-202, Method 213, Condition A
Marking Resistance to Solvents	Isopropyl alcohol + mineral spirits at 25°C; terpene defluxer at 25°C; distilled water + proylene glycol monomethyl ether + monoethanolamine at 63°C to 70°C	MIL-STD-202, Method 215