

Surface Mount Directional Coupler

DBTC-10-4-75+

75Ω 10 dB 5 to 1000 MHz

Features

- very flat coupling
- very broadband, multi octave
- temperature stable, LTCC base
- all welded construction
- leads attached for better solderability
- micro miniature coupler
- aqueous washable
- protected by US Patents 6,140,887 & 6,784,521

Applications

- cable tv

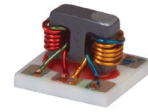

Generic photo used for illustration purposes only

CASE STYLE: AT790-1

+RoHS Compliant

The +Suffix identifies RoHS Compliance. See our web site for RoHS Compliance methodologies and qualifications

Available Tape and Reel at no extra cost	
Reel Size	Devices/Reel
7"	20, 50, 100, 200, 500
13"	1000, 2000

Electrical Specifications at 25°C

Parameter	Condition (MHz)	Min.	Typ.	Max.	Unit
Frequency Range		5		1000	MHz
Mainline Loss ¹	5-50	—	1.5	2.2	dB
	50-500	—	1.4	2.0	
	500-1000	—	1.5	2.0	
Nominal Coupling	5-1000	—	10.5±0.5	—	dB
Coupling Flatness(±)	5-1000	—	—	0.7	dB
Directivity	5-50	16	21	—	dB
	50-500	13	20	—	
	500-1000	—	16	—	
VSWR ²	5-1000	—	1.3	—	dB
Input Power	5-500	—	—	0.5	W
	500-1000	—	—	1.0	

1. Includes theoretical coupled power loss of 0.4 dB at 10 dB coupling.

2. For coupled port VSWR above 500 MHz, 1.6:1 typ.

Maximum Ratings

Parameter	Ratings
Operating Temperature	-40°C to 85°C
Storage Temperature	-55°C to 100°C

Permanent damage may occur if any of these limits are exceeded.

Pin Connections

Function	Pin Number
INPUT	3
OUTPUT	4
COUPLED	1
GROUND	2
ISOLATE (DO NOT USE)	6

Electrical Schematic

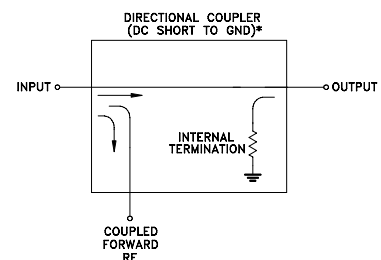

* ELECTRICAL SCHEMATIC IS FOR DIRECTIONAL COUPLER WITH INTERNAL TRANSFORMER(S) THAT ROUTES DC FROM RF PORTS TO GROUND.



Outline Drawing

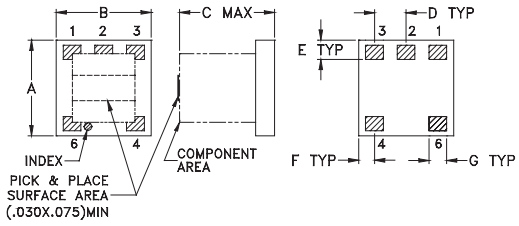

PCB Land Pattern

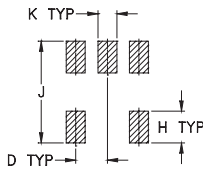

Suggested Layout,
Tolerance to be within ± 0.002

Demo Board MCL P/N: TB-279
Suggested PCB Layout (PL-151)

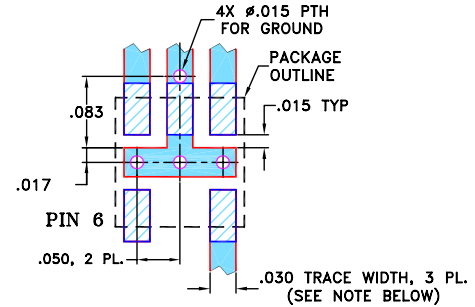

NOTES: 1. TRACE WIDTH IS SHOWN FOR ROGERS RO4350B WITH DIELECTRIC THICKNESS $0.030" \pm 0.002"$; COPPER: 1/2 OZ. EACH SIDE. FOR OTHER MATERIALS TRACE WIDTH MAY NEED TO BE MODIFIED.
2. BOTTOM SIDE OF THE PCB IS CONTINUOUS GROUND PLANE.

- DENOTES PCB COPPER LAYOUT WITH SMOBC (SOLDER MASK OVER BARE COPPER)
- DENOTES COPPER LAND PATTERN FREE OF SOLDER MASK

Outline Dimensions (inch/mm)

A	B	C	D	E	F	G	H	J	K	wt
.150	.150	.150	.050	.030	.025	.028	.050	.160	.030	grams
3.81	3.81	3.81	1.27	0.76	0.64	0.71	1.27	4.06	0.76	0.10

Typical Performance Data

Frequency (MHz)	Mainline Loss (dB) In-Out	Coupling (dB) In-Cpl	Directivity (dB)	Return Loss (dB)		
				In	Out	Cpl
5.00	1.53	10.44	21.95	12.96	18.66	14.22
7.00	1.45	10.32	21.83	13.63	20.55	15.21
10.00	1.39	10.24	21.71	14.11	22.29	15.95
30.00	1.37	10.21	21.54	14.66	25.03	16.80
50.00	1.38	10.21	21.49	14.79	25.45	16.88
70.00	1.38	10.22	21.42	14.86	25.51	16.83
100.00	1.39	10.24	21.31	14.98	25.34	16.64
500.00	1.33	10.35	19.83	16.88	19.74	11.59
700.00	1.34	10.46	19.25	18.06	18.15	9.84
1000.00	1.41	10.70	18.57	16.64	18.44	8.57

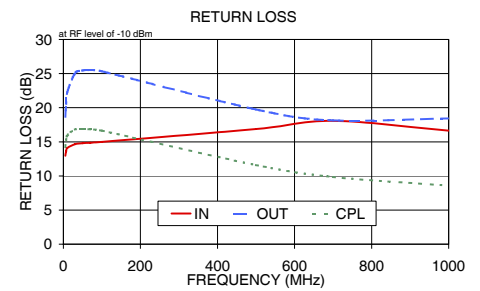
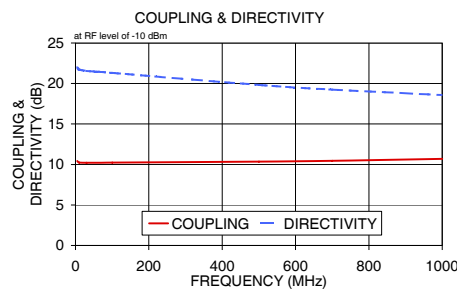
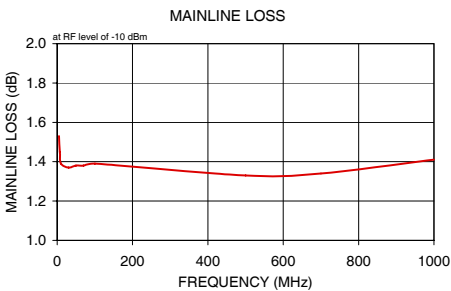

Additional Notes

- A. Performance and quality attributes and conditions not expressly stated in this specification document are intended to be excluded and do not form a part of this specification document.
- B. Electrical specifications and performance data contained in this specification document are based on Mini-Circuit's applicable established test performance criteria and measurement instructions.
- C. The parts covered by this specification document are subject to Mini-Circuits standard limited warranty and terms and conditions (collectively, "Standard Terms"); Purchasers of this part are entitled to the rights and benefits contained therein. For a full statement of the Standard Terms and the exclusive rights and remedies thereunder, please visit Mini-Circuits' website at www.minicircuits.com/MCLStore/terms.jsp

Directional Coupler

DBTC-10-4-75+

Typical Performance Data

TEST CONDITIONS: INPUT POWER =0 dBm @Temperature = +25°C

FREQUENCY (MHz)	INSERTION LOSS (dB)	COUPLING LOSS (dB)	DIRECTIVITY (dB)	RETURN LOSS		
				IN	(dB) OUT	CPL
5.0	1.53	10.24	20.26	16.21	22.03	16.09
10.0	1.51	10.24	20.48	16.48	23.17	16.36
15.0	1.49	10.23	20.70	16.75	24.29	16.63
20.0	1.50	10.24	20.70	16.76	24.36	16.64
25.0	1.50	10.25	20.69	16.77	24.43	16.64
50.0	1.52	10.27	20.64	16.81	24.47	16.64
75.0	1.52	10.29	20.61	16.90	24.55	16.66
100.0	1.53	10.31	20.64	17.00	24.61	16.68
150.0	1.53	10.32	20.57	17.16	24.44	16.53
200.0	1.52	10.34	20.46	17.25	24.02	16.30
250.0	1.51	10.36	20.37	17.34	23.50	15.98
300.0	1.51	10.38	20.24	17.48	22.86	15.61
350.0	1.50	10.40	20.07	17.56	22.23	15.21
400.0	1.50	10.42	19.96	17.58	21.64	14.81
450.0	1.49	10.45	19.73	17.66	21.13	14.41
475.0	1.49	10.46	19.73	17.76	20.92	14.21
500.0	1.49	10.48	19.44	17.82	20.71	14.03
550.0	1.49	10.51	19.26	17.92	20.38	13.68
600.0	1.49	10.54	19.18	18.08	20.17	13.39
650.0	1.50	10.58	18.96	18.40	20.04	13.13
700.0	1.50	10.61	18.82	18.77	20.02	12.90
750.0	1.49	10.64	18.78	19.03	20.03	12.68
800.0	1.49	10.68	18.82	19.44	20.18	12.48
850.0	1.48	10.72	18.97	20.08	20.45	12.33
900.0	1.48	10.75	18.90	20.71	20.79	12.20
950.0	1.48	10.81	18.42	21.22	21.18	12.05
1000.0	1.48	10.87	18.00	21.76	21.55	11.90
1050.0	1.48	10.92	17.57	22.33	22.01	11.72
1100.0	1.48	10.99	17.01	22.90	22.56	11.56
1150.0	1.48	11.06	16.28	23.36	23.12	11.39
1200.0	1.50	11.17	15.11	23.66	23.59	11.19
1250.0	1.51	11.25	14.06	23.79	23.96	10.94
1300.0	1.54	11.35	13.10	23.61	24.38	10.69
1350.0	1.57	11.43	12.12	23.35	24.55	10.43
1400.0	1.61	11.53	11.22	23.27	24.61	10.15
1450.0	1.65	11.61	10.68	22.96	24.41	9.82
1500.0	1.69	11.70	10.33	22.32	24.10	9.51
1600.0	1.82	11.90	9.45	21.61	22.91	8.94
1700.0	1.97	12.12	9.05	20.56	21.26	8.38
1800.0	2.18	12.36	9.23	19.85	19.51	7.90
1900.0	2.36	12.69	9.29	18.87	17.69	7.52
2000.0	2.49	13.04	9.82	18.26	16.15	7.19
2100.0	2.58	13.47	9.59	17.33	14.74	6.95
2200.0	2.59	13.92	9.21	16.47	13.30	6.81
2300.0	2.52	14.47	7.88	15.53	11.95	6.71
2400.0	2.58	14.97	6.56	14.87	10.94	6.65
2500.0	2.98	15.25	5.19	14.35	10.15	6.67
2750.0	4.47	15.73	4.30	13.82	8.70	6.78
3000.0	5.84	15.71	6.68	13.01	7.71	6.89
3250.0	5.29	15.46	9.29	12.77	7.54	6.71
3500.0	4.33	17.47	3.04	11.61	6.59	6.43
3750.0	6.56	18.26	0.25	10.96	6.27	6.26
4000.0	9.64	15.96	3.42	10.95	5.72	6.33



Directional Coupler

DBTC-10-4-75+

Typical Performance Data

TEST CONDITIONS: INPUT POWER =0 dBm @Temperature = -40°C

FREQUENCY (MHz)	INSERTION LOSS (dB)	COUPLING LOSS (dB)	DIRECTIVITY (dB)	RETURN LOSS (dB)		
				IN	OUT	CPL
5.0	1.76	10.39	18.53	13.90	16.35	13.58
10.0	1.55	10.23	19.07	15.74	20.04	15.24
15.0	1.33	10.07	19.62	17.57	23.73	16.90
20.0	1.32	10.06	19.72	17.95	25.14	17.26
25.0	1.30	10.05	19.82	18.34	26.55	17.62
50.0	1.29	10.06	20.06	19.30	28.78	18.53
75.0	1.29	10.07	20.09	19.53	29.36	18.77
100.0	1.29	10.09	20.12	18.95	29.40	18.31
150.0	1.30	10.09	20.09	18.48	28.43	17.31
200.0	1.31	10.11	20.10	18.97	27.14	17.39
250.0	1.31	10.12	19.98	18.09	25.95	16.43
300.0	1.31	10.14	19.93	17.93	24.57	15.61
350.0	1.31	10.16	19.81	17.73	23.31	15.28
400.0	1.31	10.18	19.76	17.11	22.07	14.45
450.0	1.31	10.20	19.63	17.01	21.01	13.92
475.0	1.30	10.20	19.63	16.96	20.59	13.73
500.0	1.31	10.23	19.42	16.84	20.16	13.50
550.0	1.31	10.26	19.35	16.89	19.50	12.98
600.0	1.32	10.27	19.37	17.08	19.08	12.70
650.0	1.32	10.30	19.26	17.33	18.82	12.46
700.0	1.32	10.31	19.29	17.85	18.77	12.33
750.0	1.31	10.34	19.31	18.45	18.85	12.27
800.0	1.31	10.35	19.46	19.55	19.20	12.27
850.0	1.30	10.36	19.70	20.77	19.75	12.39
900.0	1.30	10.38	19.67	22.24	20.42	12.47
950.0	1.29	10.41	19.14	23.92	21.22	12.59
1000.0	1.29	10.45	18.46	25.63	22.13	12.60
1050.0	1.27	10.50	17.75	26.07	23.36	12.43
1100.0	1.27	10.54	16.93	24.51	24.85	12.25
1150.0	1.27	10.60	16.06	22.79	26.51	11.76
1200.0	1.28	10.69	14.73	20.98	28.07	11.21
1250.0	1.29	10.76	13.61	20.05	28.99	10.65
1300.0	1.31	10.84	12.58	19.06	29.70	10.00
1350.0	1.33	10.93	11.55	17.98	29.21	9.41
1400.0	1.36	11.02	10.62	17.75	28.47	8.90
1450.0	1.38	11.09	10.10	17.90	27.41	8.49
1500.0	1.42	11.16	9.79	18.44	26.23	8.17
1600.0	1.52	11.35	8.99	18.56	23.51	7.78
1700.0	1.66	11.57	8.75	20.58	20.61	7.90
1800.0	1.88	11.79	9.15	22.21	18.40	8.17
1900.0	2.07	12.10	9.40	28.98	16.60	8.56
2000.0	2.21	12.41	10.23	27.54	15.57	8.42
2100.0	2.28	12.77	9.93	20.17	14.74	7.67
2200.0	2.26	13.23	9.24	16.15	13.58	6.63
2300.0	2.16	13.79	7.58	13.10	12.15	5.45
2400.0	2.21	14.27	6.12	11.30	10.97	4.65
2500.0	2.63	14.65	4.65	9.68	9.99	4.32
2750.0	4.21	15.32	4.00	9.44	8.06	5.51
3000.0	5.82	15.17	7.16	13.90	6.95	8.85
3250.0	5.17	14.90	9.85	17.59	6.93	7.24
3500.0	3.80	17.17	1.38	9.30	6.12	3.70
3750.0	5.97	17.85	0.94	5.87	6.17	2.96
4000.0	8.97	15.03	3.25	5.70	5.92	4.83



Directional Coupler

DBTC-10-4-75+

Typical Performance Data

TEST CONDITIONS: INPUT POWER =0 dBm @Temperature = +85°C

FREQUENCY (MHz)	INSERTION LOSS (dB)	COUPLING LOSS (dB)	DIRECTIVITY (dB)	RETURN LOSS		
				IN	(dB) OUT	CPL
5.0	1.87	10.47	19.79	14.68	18.96	14.83
10.0	1.85	10.46	19.96	14.92	19.73	15.06
15.0	1.83	10.46	20.14	15.16	20.50	15.29
20.0	1.83	10.47	20.11	15.10	20.55	15.24
25.0	1.83	10.48	20.08	15.05	20.60	15.20
50.0	1.84	10.51	20.03	14.77	20.69	14.89
75.0	1.85	10.53	20.01	14.83	20.75	14.84
100.0	1.84	10.54	20.03	15.28	20.79	15.12
150.0	1.83	10.56	19.94	15.83	20.89	15.63
200.0	1.82	10.59	19.76	15.76	21.00	15.34
250.0	1.80	10.61	19.68	16.46	21.04	15.50
300.0	1.79	10.64	19.47	16.78	21.07	15.59
350.0	1.78	10.67	19.25	16.94	21.02	15.25
400.0	1.76	10.71	19.03	17.44	20.92	15.14
450.0	1.76	10.76	18.74	17.71	20.87	15.04
475.0	1.75	10.77	18.66	17.84	20.89	14.86
500.0	1.75	10.81	18.36	17.94	20.81	14.69
550.0	1.74	10.86	18.11	18.22	20.75	14.45
600.0	1.74	10.91	17.96	18.33	20.74	14.20
650.0	1.73	10.97	17.71	18.50	20.68	13.84
700.0	1.73	11.03	17.52	18.74	20.56	13.53
750.0	1.73	11.09	17.42	18.65	20.41	13.16
800.0	1.72	11.14	17.42	18.68	20.27	12.71
850.0	1.72	11.20	17.51	19.11	20.26	12.40
900.0	1.72	11.26	17.42	19.33	20.27	12.19
950.0	1.72	11.34	17.09	19.60	20.28	11.90
1000.0	1.72	11.43	16.79	19.90	20.26	11.69
1050.0	1.73	11.50	16.68	20.38	20.38	11.51
1100.0	1.73	11.59	16.31	21.35	20.66	11.33
1150.0	1.75	11.68	15.75	22.44	21.10	11.26
1200.0	1.77	11.79	14.85	23.74	21.60	11.26
1250.0	1.79	11.89	13.95	25.41	22.12	11.20
1300.0	1.84	11.98	13.10	26.96	22.85	11.17
1350.0	1.88	12.08	12.21	27.91	23.49	11.13
1400.0	1.92	12.17	11.37	28.15	24.21	11.00
1450.0	1.98	12.25	10.87	26.50	24.88	10.76
1500.0	2.03	12.34	10.50	24.45	25.37	10.47
1600.0	2.18	12.54	9.51	21.53	24.83	9.79
1700.0	2.32	12.78	9.09	19.01	22.55	8.75
1800.0	2.50	12.99	9.10	17.72	20.17	7.90
1900.0	2.66	13.34	9.05	16.48	17.69	7.25
2000.0	2.75	13.68	9.45	16.17	15.70	6.82
2100.0	2.82	14.09	9.36	15.97	14.24	6.70
2200.0	2.83	14.50	9.24	16.04	12.97	6.91
2300.0	2.79	14.99	8.16	16.35	11.91	7.32
2400.0	2.86	15.44	7.05	17.28	11.39	7.56
2500.0	3.24	15.64	5.69	17.83	10.96	7.81
2750.0	4.59	16.00	4.57	16.39	10.05	7.15
3000.0	5.76	16.01	6.43	12.44	8.25	6.18
3250.0	5.13	15.61	9.34	11.43	7.49	6.22
3500.0	4.13	17.25	4.05	11.67	6.71	7.07
3750.0	6.05	18.31	0.39	12.66	6.87	7.24
4000.0	9.32	16.35	3.29	12.92	6.27	6.34



P.O. Box 350166, Brooklyn, New York 11235-0003 (718) 934-4500 • Fax (718) 332-4661 For detailed performance specs & shopping online see Mini-Circuits web site



The Design Engineers Search Engine Provides ACTUAL Data Instantly From MINI-CIRCUITS At: www.minicircuits.com

IF/RF MICROWAVE COMPONENTS

REV. OR
DBTC-10-4-75+
3/15/2013
Page 3 of 3

Directional Coupler

Typical Performance Curves

DBTC-10-4-75+

Insertion Loss

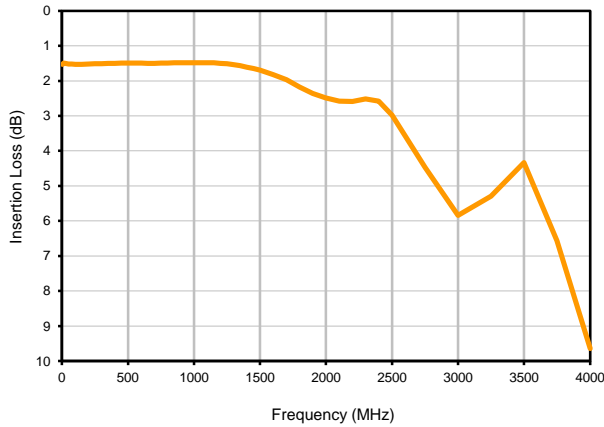

Insertion Loss vs. TEMPERATURE

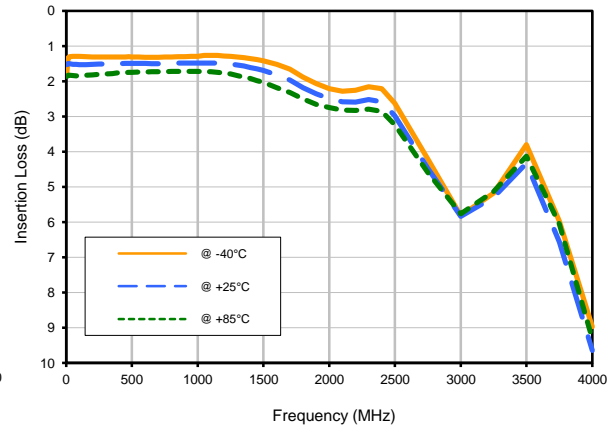

Coupling Loss vs. TEMPERATURE

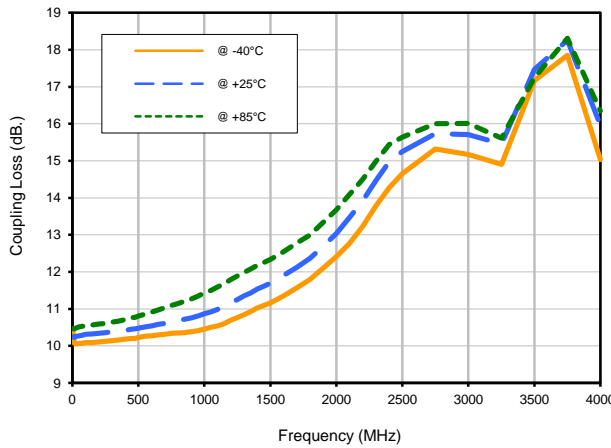

Directivity vs. TEMPERATURE

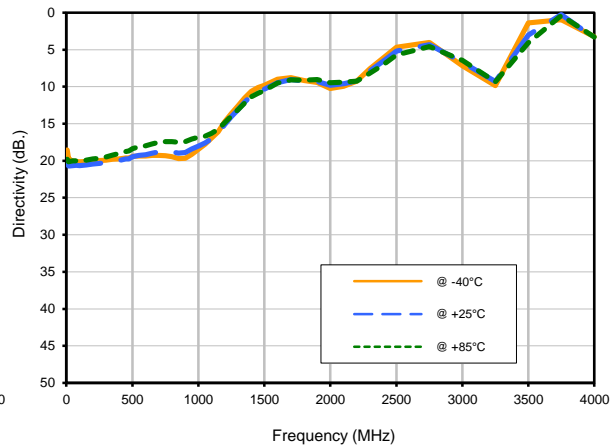

Directional Coupler

Typical Performance Curves

DBTC-10-4-75+

Return Loss

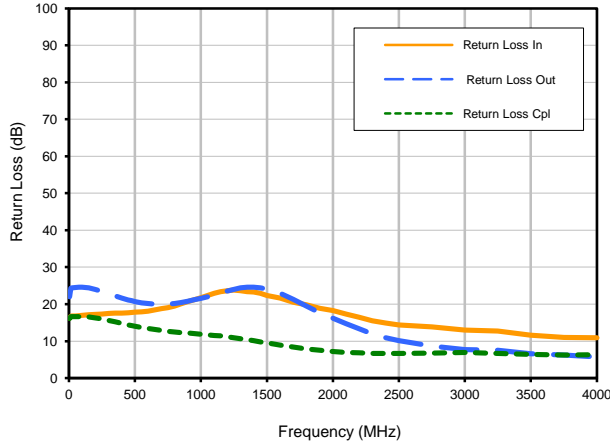

Return Loss In vs. TEMPERATURE

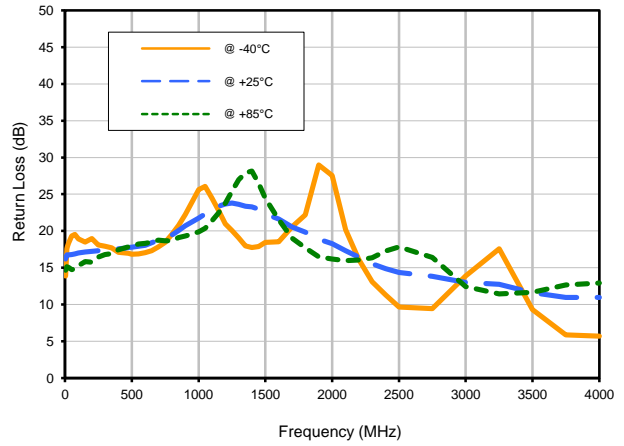

Return Loss Out vs. TEMPERATURE

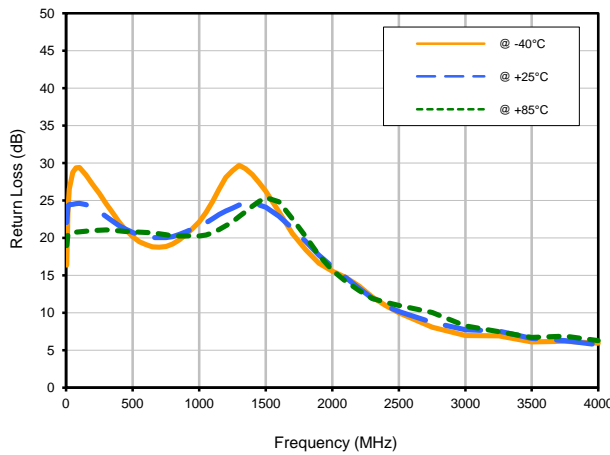

Return Loss Cpl vs. TEMPERATURE

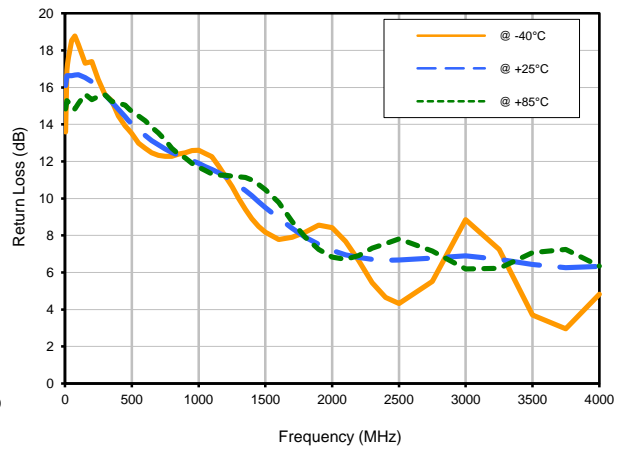

Outline Dimensions

AT790-1

PCB Land Pattern

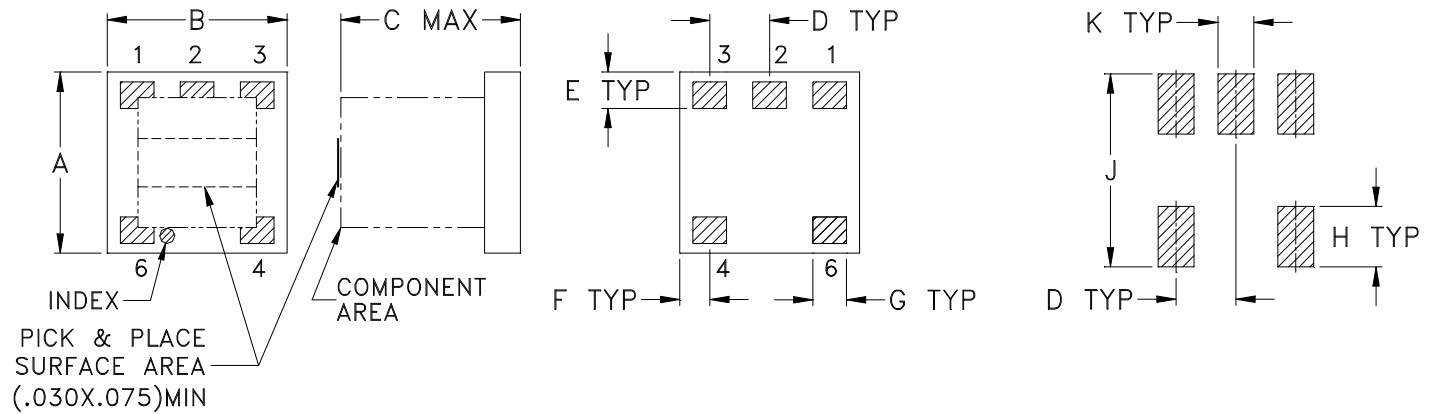

Suggested Layout,
Tolerance to be within $\pm .002$

CASE #	A	B	C	D	E	F	G	H	J	K	L	WT. GRAMS
AT790-1	.150 (3.81)	.150 (3.81)	.150 (3.81)	.050 (1.27)	.030 (0.76)	.025 (0.64)	.028 (0.71)	.050 (1.27)	.160 (4.06)	.030 (0.76)	-- --	.10

Dimensions are in inches (mm). Tolerances: 2 Pl. $\pm .01$; 3 Pl. $\pm .005$

Notes:

1. Open style, Ceramic base.
2. Termination finish: Silver palladium or gold over nickel based on stock availability



P.O. Box 350166, Brooklyn, New York 11235-0003 (718) 934-4500 Fax (718) 332-4661 For detailed performance specs & shopping online see Mini-Circuits web site



The Design Engineers Search Engine Provides ACTUAL Data Instantly From MINI-CIRCUITS At: www.minicircuits.com

RF/IF MICROWAVE COMPONENTS

Tape & Reel Packaging TR-F17

DEVICE ORIENTATION IN T&R

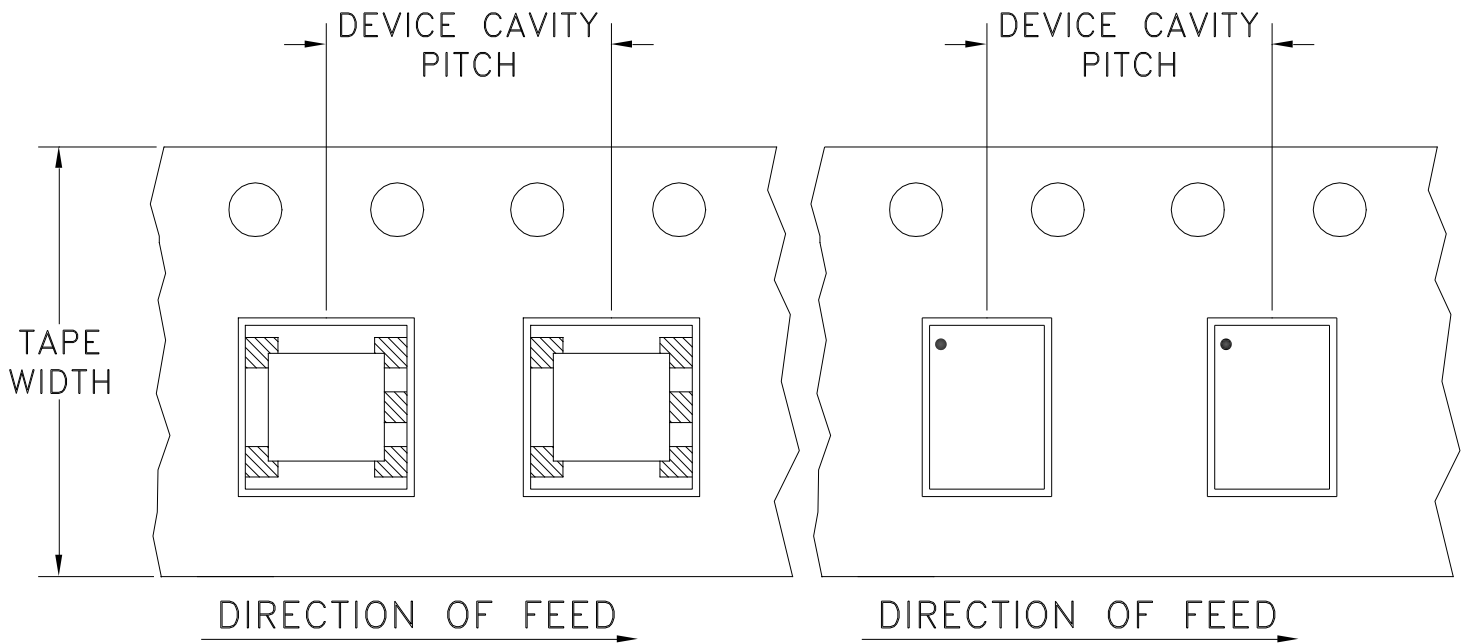

Tape Width, mm	Device Cavity Pitch, mm	Reel Size, inches	Devices per Reel	
12	8	7	Small quantity standards (see note)	20
				50
				100
				200
				500
		13	Standard	1000
2000				

Note: Please Consult individual model data sheet to determine device per reel availability.

Mini-Circuits carrier tape materials provide protection from ESD (Electro-Static Discharge) during handling and transportation. Tapes are static dissipative and comply with industry standards EIA-481/EIA-541.

Go to: www.minicircuits.com/pages/pdfs/tape.pdf



P.O. Box 350166, Brooklyn, New York 11235-0003 (718) 934-4500 Fax (718) 332-4661 For detailed performance specs & shopping online see Mini-Circuits web site



The Design Engineers Search Engine Provides ACTUAL Data Instantly From MINI-CIRCUITS At: www.minicircuits.com

RF/IF MICROWAVE COMPONENTS

THIRD ANGLE PROJECTION

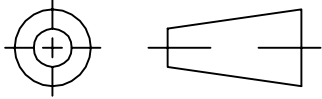

REVISIONS

REV	ECN No.	DESCRIPTION	DATE	DR	AUTH
OR	M90455	NEW RELEASE	01/16/04	AV	WP
A	M102713	ADDED "...WITH SMOBC"	01/17/06	MMG	IL

SUGGESTED MOUNTING CONFIGURATION FOR AT1029 CASE STYLE, "na" PIN CONNECTION

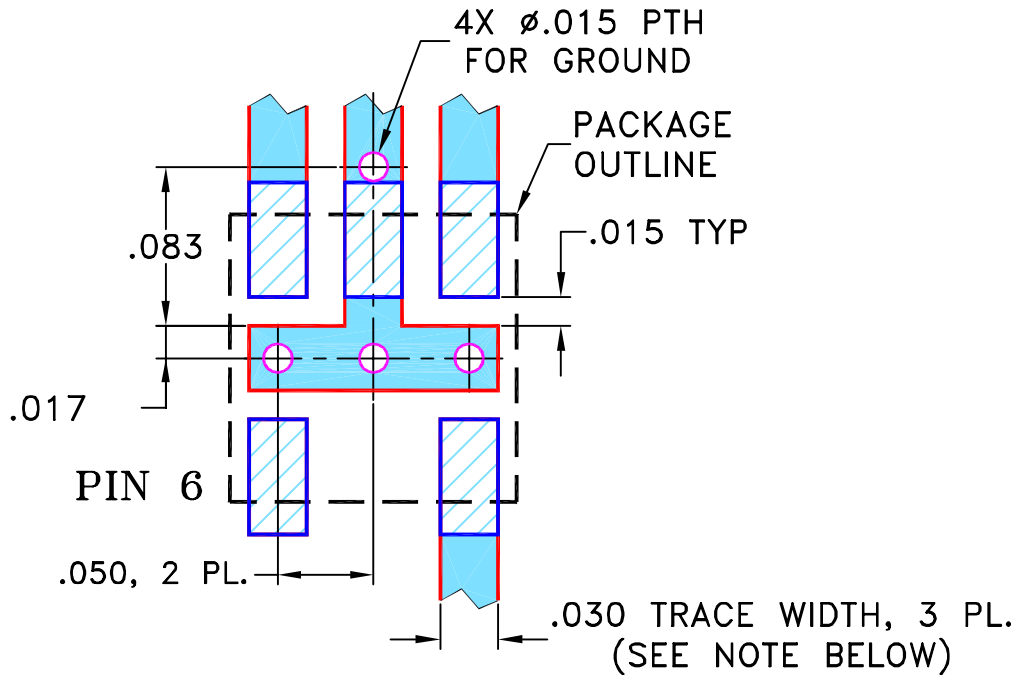

- NOTES: 1. TRACE WIDTH IS SHOWN FOR ROGERS R04350B WITH DIELECTRIC THICKNESS 0.030" ± 0.002"; COPPER: 1/2 OZ. EACH SIDE. FOR OTHER MATERIALS TRACE WIDTH MAY NEED TO BE MODIFIED.
 2. BOTTOM SIDE OF THE PCB IS CONTINUOUS GROUND PLANE.



DENOTES PCB COPPER LAYOUT WITH SMOBC (SOLDER MASK OVER BARE COPPER)



DENOTES COPPER LAND PATTERN FREE OF SOLDER MASK

UNLESS OTHERWISE SPECIFIED	INITIALS	DATE
DIMENSIONS ARE IN INCHES	DRAWN AV	01/07/04
TOLERANCES ON:	CHECKED IL	01/16/04
2 PL DECIMALS ±	APPROVED WP	01/16/04
3 PL DECIMALS ± .005		
ANGLES ±		
FRACTIONS ±		



Mini-Circuits® 13 Neptune Avenue
Brooklyn NY 11235

PL, na, 75, AT1029, DBTC, TB-279

SIZE A	CODE IDENT 15542	DRAWING NO: 98-PL-151	REV: A
FILE: 98PL151	SCALE: 10:1	SHEET: 1 OF 1	

Mini-Circuits®
 THIS DOCUMENT AND ITS CONTENTS ARE THE PROPERTY OF MINI-CIRCUITS. EXCEPT FOR USE EXPRESSLY GRANTED, IN WRITING, TO ITS VENDORS, VENDEE AND THE UNITED STATES GOVERNMENT, MINI-CIRCUITS RESERVES ALL PROPRIETARY DESIGN, USE, MANUFACTURING AND REPRODUCTION RIGHTS THERETO. THESE CONTENTS SHALL NOT BE USED, DUPLICATED OR DISCLOSED TO ANY OUTSIDE PARTY, IN WHOLE OR IN PART, WITHOUT WRITTEN PERMISSION OF MINI-CIRCUITS.

Evaluation Board and Circuit

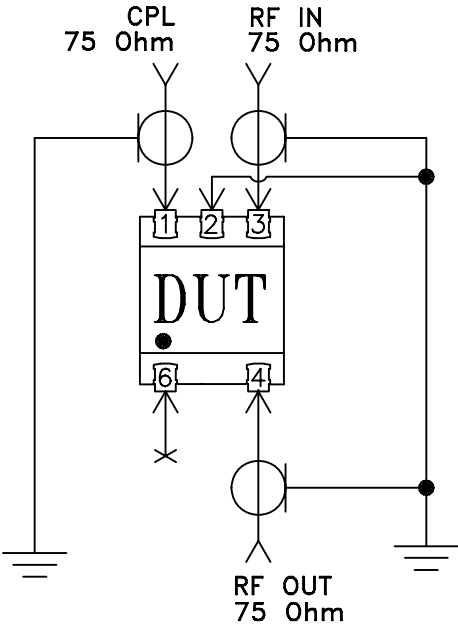
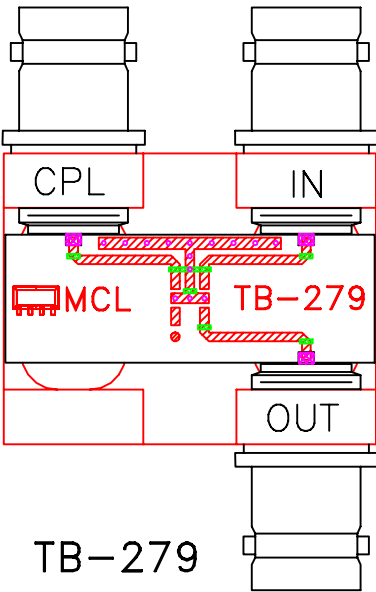

Schematic Diagram

Notes:

1. BNC Female connectors.
2. PCB Material: Rogers R04350 or equivalent,
Dielectric Constant=3.5, Thickness=.030 inch.

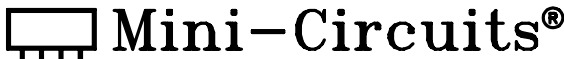



All Mini-Circuits products are manufactured under exacting quality assurance and control standards, and are capable of meeting published specifications after being subjected to any or all of the following physical and environmental test.

Specification	Test/Inspection Condition	Reference/Spec
Operating Temperature	-40° to 85°C Ambient Environment	Individual Model Data Sheet
Storage Temperature	-55° to 100° C Ambient Environment	Individual Model Data Sheet
Humidity	90 to 95% RH, 240 hours, 50°C	MIL-STD-202, Method 103, Condition A, Except 50°C and end-point electrical test done within 12 hours
Thermal Shock	-55° to 100°C, 100 cycles	MIL-STD-202, Method 107, Condition A-3, except +100°C
Solder Reflow Heat	Sn-Pb Eutetic Process: 225°C peak Pb-Free Process 245° - 250°C peak	J-STD-020, Table 4-1, 4-2 and 5-2, Figure 5-1
Solderability	10X Magnification	J-STD-002, 95% Coverage
Vibration (High Frequency)	20g peak, 10-2000 Hz, 12 times in each of three perpendicular directions (total 36)	MIL-STD-202, Method 204, Condition D
Mechanical Shock	50g, 11 ms, 1/2-sine, 18 shocks: 3 each direction, each of 3 axes	MIL-STD-202, Method 213, Condition A
Marking Resistance to Solvents	Isopropyl alcohol + mineral spirits at 25°C; terpene defluxer at 25°C; distilled water + proylene glycol monomethyl ether + monoethanolamine at 63°C to 70°C	MIL-STD-202, Method 215