

Digital Step Attenuator

50Ω DC-4000 MHz

31.5 dB, 0.5 dB Step

6 Bit, Parallel Control Interface, Dual Supply Voltage

Product Features

- Immune to latch up
- Excellent accuracy, 0.1 dB Typ
- Parallel control interface
- Fast switching control frequency, up to 1 MHz typ.
- Low Insertion Loss
- High IP3, +52 dBm Typ
- Very low DC power consumption
- Excellent return loss, 20 dB Typ
- Small size 4.0 x 4.0 mm

Typical Applications

- Base Station Infrastructure
- Portable Wireless
- CATV & DBS
- MMDS & Wireless LAN
- Wireless Local Loop
- UNII & Hiper LAN
- Power amplifier distortion canceling loops

General Description

The DAT-31R5A-PN-2+ is a 50Ω RF digital step attenuator that offers an attenuation range of 31.5 dB in 0.5 dB steps. The control is a 6-bit parallel interface, operating on dual supply voltage (positive & negative). The DAT-31R5A-PN-2+ is produced using a unique CMOS process on silicon, offering the performance of GaAs, with the advantages of conventional CMOS devices.



Generic photo used for illustration purposes only

DAT-31R5A-PN-2+

CASE STYLE: DG983-2

+RoHS Compliant

The +Suffix identifies RoHS Compliance. See our web site for RoHS Compliance methodologies and qualifications

Simplified Schematic

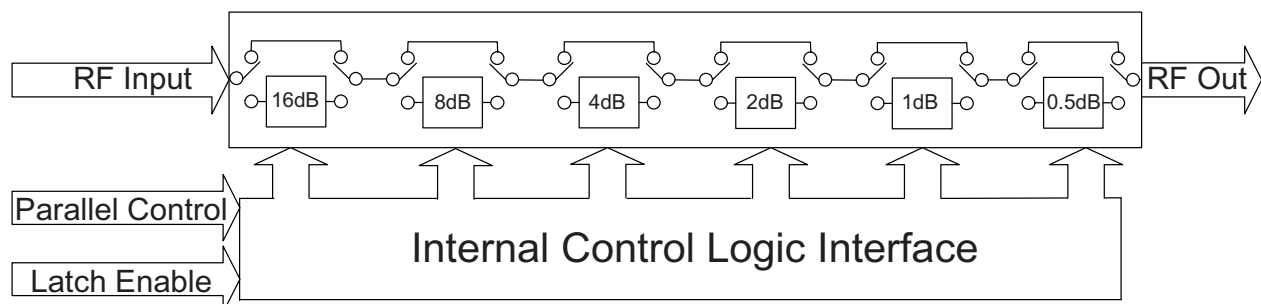

RF Electrical Specifications ^(Note 1), DC-4000 MHz, $T_{AMB}=25^{\circ}C$, $V_{DD}=+3V$, $V_{SS}=-3.2V$

Parameter	Freq. Range (GHz)	Min.	Typ.	Max.	Units
Accuracy @ 0.5 dB Attenuation Setting	DC-1	—	0.03	0.1	dB
	1-2.4	—	0.05	0.15	
	2.4-4	—	0.07	0.2	
Accuracy @ 1 dB Attenuation Setting	DC-1	—	0.02	0.1	dB
	1-2.4	—	0.05	0.15	
	2.4-4	—	0.1	0.25	
Accuracy @ 2 dB Attenuation Setting	DC-1	—	0.05	0.15	dB
	1-2.4	—	0.15	0.25	
	2.4-4	—	0.15	0.35	
Accuracy @ 4 dB Attenuation Setting	DC-1	—	0.07	0.2	dB
	1-2.4	—	0.15	0.25	
	2.4-4	—	0.23	0.5	
Accuracy @ 8 dB Attenuation Setting	DC-1	—	0.03	0.2	dB
	1-2.4	—	0.15	0.5	
	2.4-4	—	0.6	0.8	
Accuracy @ 16 dB Attenuation Setting	DC-1	—	0.1	0.3	dB
	1-2.4	—	0.15	0.7	
	2.4-4	—	1.1	1.45	
Insertion Loss ^(note 2) @ all attenuator set to 0dB	DC-1	—	1.3	1.9	dB
	1-2.4	—	1.6	2.4	
	2.4-4	—	2.1	3.0	
Input IP3 ^(note 3) (at Min. and Max. Attenuation)	DC-4	—	+52	—	dBm
Input Power @ 0.2dB Compression ^(note 3) (at Min. and Max. Attenuation)	DC-4	—	+24	—	dBm
Input Operating Power	10 kHz to 50 MHz	—	—	See Fig. 1	dBm
	>50 MHz	—	—	+24	
VSWR	DC-1	—	1.2	1.5	:1
	1-2.4	—	1.2	1.6	
	2.4-4	—	1.4	1.9	

Notes:

1. Tested on Evaluation Board TB-340, See Figure 3.
2. Insertion loss values are de-embedded from test board Loss (test board's Insertion Loss: 0.10dB @ 100MHz, 0.35dB @ 1000MHz, 0.60dB @ 2400MHz, 0.75dB @ 4000MHz).
3. Input IP3 and 1dB compression degrades below 1 MHz. Input power not to exceed max operating specification for continuous operation.

DC Electrical Specifications

Parameter	Min.	Typ.	Max.	Units
V_{DD} , Supply Voltage	2.7	3	3.6 ^(Note 4)	V
V_{SS} , Supply Voltage	-3.6	-3.3	-3.2	V
I_{DD} Supply Current	—	—	100	μA
I_{SS} Supply Current	—	16	40	μA
Control Input Low	-0.3	—	+0.6	V
Control Input High	1.17	—	3.6	V
Control Current	—	—	20 ^(Note 5)	μA

4. For operation above +3.6V, see Application Note AN-70-006
5. Except, 30 μA typ for C0.5, C16, PUP1 at +3.6V

Absolute Maximum Ratings ^(Note 6,7)

Parameter	Ratings
Operating Temperature	-40°C to 105°C
Storage Temperature	-65°C to 150°C
V_{DD}	-0.3V Min., 5.5V Max.
V_{SS}	-3.5V Min., 0.3V Max.
Voltage on any control input	-0.3V Min., 3.6V Max.
Input Power	+30dBm
Thermal Resistance	37°C/W

6. Permanent damage may occur if any of these limits are exceeded.
7. Operation between max operating and absolute max input power will result in reduced reliability.

Switching Specifications

Parameter	Min.	Typ.	Max.	Units
Switching Speed, 50% Control to 0.5dB of Attenuation Value	—	1.0	—	μSec
Switching Control Frequency	—	1.0	—	mHz

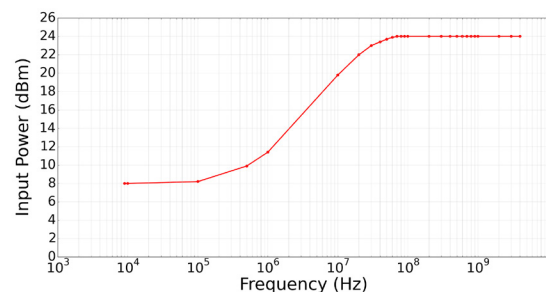

Figure 1. Max Input Operating Power vs Frequency

Pin Description

Function	Pin Number	Description
C16	1	Control for Attenuation bit, 16dB (Note 3,6)
RF in	2	RF in port (Note 1)
N/C	3	Not connected (Note 4)
GND	4	Ground connection
LE	5	Latch Enable Input (Note 2)
V _{DD}	6	Positive Supply Voltage
PUP1	7	Power-up selection (Note 6)
PUP2	8	Power-up selection
V _{DD}	9	Positive Supply Voltage
GND	10	Ground connection
GND	11	Ground connection
V _{SS}	12	Negative Supply Voltage
GND	13	Ground connection
RF out	14	RF out port (Note 1)
C8	15	Control for attenuation bit, 8 dB
C4	16	Control for attenuation bit, 4 dB
C2	17	Control for attenuation bit, 2 dB
GND	18	Ground Connection
C1	19	Control for attenuation bit, 1 dB
C0.5	20	Control for attenuation bit, 0.5 dB (Note 6)
GND	Paddle	Paddle ground (Note 5)

Notes:

- Both RF ports must be held at 0VDC or DC blocked with an external series capacitor.
- Latch Enable (LE) has an internal 2MΩ to internal positive supply voltage.
- Place a 10KΩ resistor in series, as close to pin as possible to avoid freq. resonance.
- Place a shunt 10KΩ resistor to GND
- The exposed solder pad on the bottom of the package (See Pin configuration) must be grounded for proper device operation.
- This pin has an internal 200 kΩ resistor to ground.

Pin Configuration (Top View)

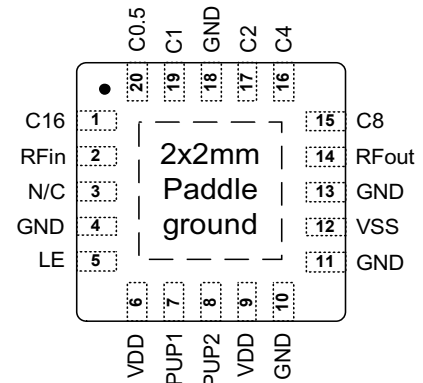

Device Marking

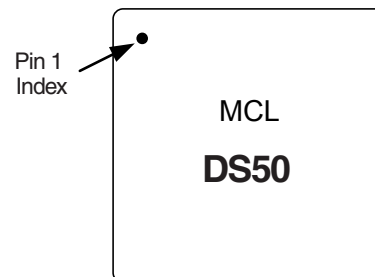

Simplified Schematic

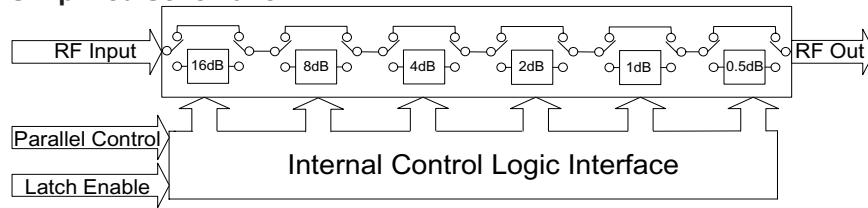

The DAT-31R5A-PN-2+ parallel interface consists of 6 control bits that select the desired attenuation state, as shown in Table 1: Truth Table

Table 1. Truth Table						
Attenuation State	C16	C8	C4	C2	C1	C0.5
Reference	0	0	0	0	0	0
0.5 (dB)	0	0	0	0	0	1
1 (dB)	0	0	0	0	1	0
2 (dB)	0	0	0	1	0	0
4 (dB)	0	0	1	0	0	0
8 (dB)	0	1	0	0	0	0
16 (dB)	1	0	0	0	0	0
31.5 (dB)	1	1	1	1	1	1

Note: Not all 64 possible combinations of C0.5 - C16 are shown in table

The parallel interface timing requirements are defined by Figure 2 (Parallel Interface Timing Diagram) and Table 2 (Parallel Interface AC Characteristics), and switching speed.

For latched parallel programming the Latch Enable (LE) should be held LOW while changing attenuation state control values, then pulse LE HIGH to LOW (per Figure 2) to latch new attenuation state into device.

For direct parallel programming, the Latch Enable (LE) line should be pulled HIGH. Changing attenuation state control values will change device state to new attenuation. Direct mode is ideal for manual control of the device (using hardware, switches, or jumpers).

Figure 2: Parallel Interface Timing Diagram

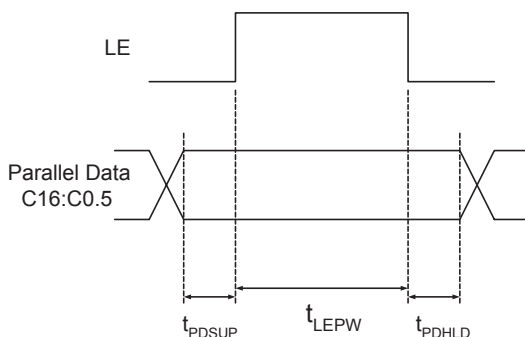

Table 2. Parallel Interface AC Characteristics				
Symbol	Parameter	Min.	Max.	Units
t_{LEPW}	LE minimum pulse width	10		ns
t_{PDSUP}	Data set-up time before clock rising edge of LE	10		ns
t_{PDHL}	Data hold time after clock falling edge of LE	10		ns

Power-up Control Settings

The DAT-31R5A-PN-2+ always assumes a specifiable attenuation setting on power-up, allowing a known attenuation state to be established before an initial parallel control word is provided.

When the attenuator powers up with LE=0, the control bits are automatically set to one of four possible values. These four values are selected by the two power-up control bits, PUP1 and PUP2, as shown in Table 3: (Power-Up Truth Table, Parallel Mode).

Table 3. Power-Up Truth Table, Parallel Mode			
Attenuation State	PUP1	PUP2	LE
Reference	0	0	0
8 (dB)	0	1	0
16 (dB)	1	0	0
31.5 (dB)	1	1	0
Defined by C0.5-C16 (See Table 1-Truth Table)	X (Note 1)	X (Note 1)	1

Note 1: PUP1 and PUP2 Connection may be 0, 1, GROUND, or not connect, without effect on attenuation state.

Power-Up with LE=1 provides normal parallel operation with C0.5-C16, and PUP1 and PUP2 are not active.

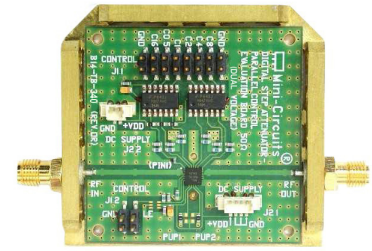

TB-340

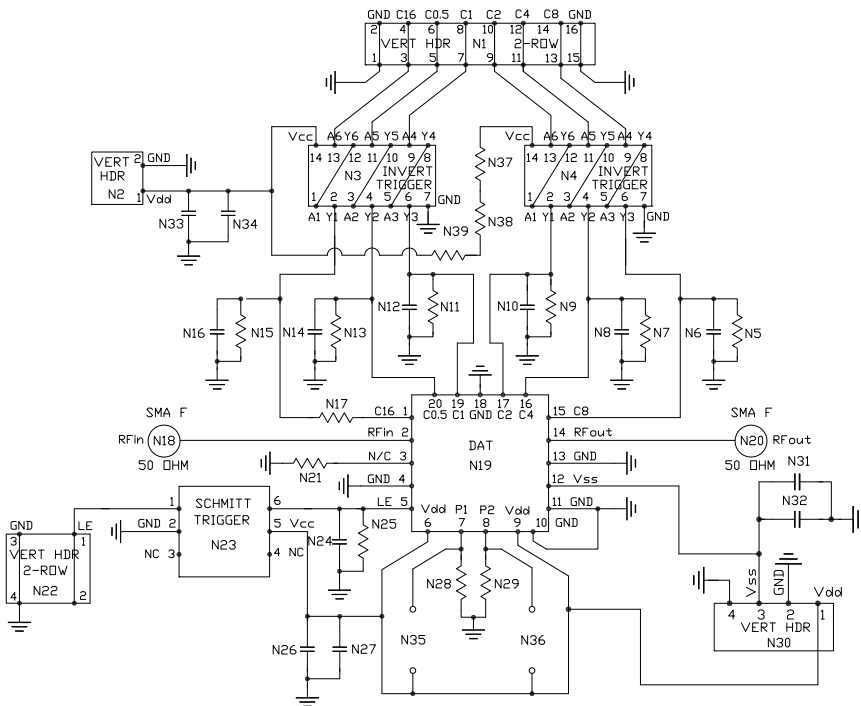

Bill of Materials (TB-340)	
N5, N7, N9, N11, N13, N15, N21 & N25	Resistor 0603 10 KOhm +/- 1%
N28 & N29	Resistor 0603 475 Ohm +/- 1%
N37 - N39	Resistor 0603 0 Ohm
N17	Resistor 0402 10 KOhm +/- 1%
N6, N8, N10, N12, N14, N16, N24, N26, N31 & N33	NPO Capacitor 0603 100pF +/- 5%
N27, N32 & N34	Tantalum Capacitor 0805 100nF +/- 10%
N3 & N4*	Hex Invert Trigger MSL1
N23*	Dual Schmitt Trigger Buffer SC-70 MSL1

Notes

- Both RF ports must be held at 0VDC or DC blocked with an external series capacitor.
- Test Board TB-340 is designed for operation for VDD=2.3 to 3.6V. For operation over 3.6V to 5.2V, See Application Note AN-70-006
- VDD=Vdd

Fig 3. Evaluation Board Schematic, TB-340, used for characterization (DUT not soldered on TB-340)

Test Equipment

For Insertion Loss, Isolation and Return Loss:

Agilent's E5071C Network Analyzer & E3631A Power Supply.

For Compression:

Agilent's N9020A Signal Analyzer, E8247C RF Generator, E3631A Power Supply & U2004A Power Sensor.

For Input IP3:

Agilent's N9020A Signal Analyzer, N5181A Signal Generators, E3631A Power Supply, U2004A Power Sensor.

For Spurs:

Agilent N5181A Signal Generator, E4440A Spectrum Analyzer.

For Switching Time:

Agilent's N5181A Signal Generator, 81110A Pulse Generator, 54832B Oscilloscope, E3631A Power Supply.

For Max Control Frequency:

Agilent's N5181A Signal Generator, N9020A Signal Analyzer, E3631A Power Supply, 81110A Pulse Generator.

Measurement Conditions

For Insertion Loss, Isolation and Return Loss:

VDD=+2.7/+3/+5.5V & Pin=0dBm

VSS=-3.2/-3.6V

For Compression: Pin=0/+24dBm. VDD=+3V, VSS=-3V

For Input IP3: Pin=+10dBm/tone.

Tone spacing: 0.1 MHz to 1 MHz RF Freq and 1 MHz to 4200 MHz RF Freq, VDD=+3V, VSS=-3V

For Spurs: RF IN at 1000MHz and -20dBm. VDD=+3V

For Switching Time:

RF Freq=501MHz/0dBm, Pulse for LE=1Hz/0/+3.4V, Delay=500ms, Width=500ms. VDD=+3V & VSS=-3V

For Max Control Frequency:

RF Freq=501MHz, 0dBm. VDD=+3V, VSS=-3V



Additional Detailed Technical Information	
<i>additional information is available on our dash board. To access this information click here</i>	
Performance Data	Data Table
	Swept Graphs
	S-Parameter (S2P Files) Data Set (.zip file)
Case Style	DG983-2 <i>Plastic package, exposed paddle, lead finish: NiPdAu</i>
Tape & Reel Standard quantities available on reel	F87 <i>7" reels with 20, 50, 100 or 200 devices</i> <i>13" reels with 3K devices</i>
Suggested Layout for PCB Design	PL-179
Evaluation Board	TB-340
Environmental Ratings	ENV33T1

ESD Rating

Human Body Model (HBM): Class 1C (1000 to <2000V) in accordance with MIL-STD-883 method 3015

MSL Rating

Moisture Sensitivity: MSL1 in accordance with IPC/JEDEC J-STD-020D

MSL Test Flow Chart

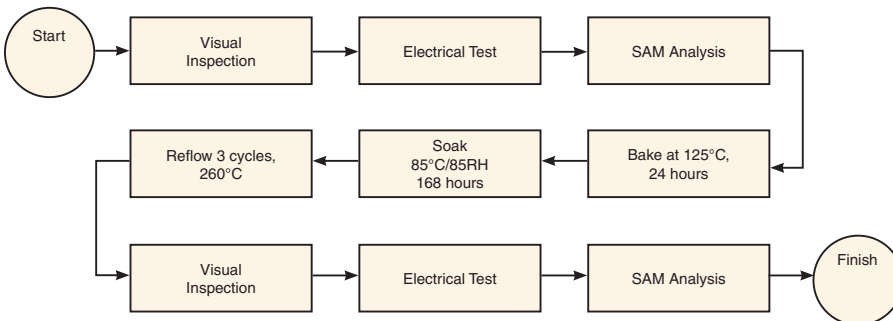

Additional Notes

- Performance and quality attributes and conditions not expressly stated in this specification document are intended to be excluded and do not form a part of this specification document.
- Electrical specifications and performance data contained in this specification document are based on Mini-Circuit's applicable established test performance criteria and measurement instructions.
- The parts covered by this specification document are subject to Mini-Circuits standard limited warranty and terms and conditions (collectively, "Standard Terms"); Purchasers of this part are entitled to the rights and benefits contained therein. For a full statement of the Standard Terms and the exclusive rights and remedies thereunder, please visit Mini-Circuits' website at www.minicircuits.com/MCLStore/terms.jsp

Digital Step Attenuator

DAT-31R5A-PN-2+

Typical Performance Data

TEST CONDITIONS: INPUT POWER=0 dBm, Vdd=+3V, Vss=-3.2V, TEMPERATURE=-40°C

FREQUENCY (MHz)	STEP ATTENUATION* AT TTL CONTROL STATE (dB)							
	000000 THRU LOSS	000001 0.5 dB	000010 1.0 dB	000100 2.0 dB	001000 4.0 dB	010000 8.0 dB	100000 16 dB	111111 31.5 dB
0.1	1.02	0.54	1.04	2.05	4.07	8.06	15.95	31.53
0.3	1.01	0.54	1.04	2.05	4.07	8.06	15.95	31.53
0.5	1.01	0.54	1.04	2.05	4.07	8.06	15.95	31.55
1	1.01	0.54	1.04	2.05	4.06	8.06	15.95	31.53
5	1.04	0.54	1.04	2.05	4.06	8.06	15.95	31.54
10	1.04	0.54	1.04	2.05	4.07	8.06	15.95	31.54
50	1.06	0.54	1.04	2.05	4.06	8.06	15.95	31.53
100	1.06	0.54	1.04	2.05	4.06	8.05	15.94	31.51
200	1.07	0.54	1.04	2.05	4.06	8.05	15.94	31.51
300	1.07	0.54	1.04	2.05	4.07	8.07	15.96	31.53
400	1.07	0.54	1.04	2.06	4.07	8.07	15.97	31.52
500	1.08	0.54	1.04	2.06	4.07	8.08	15.97	31.50
600	1.10	0.54	1.04	2.05	4.07	8.07	15.95	31.42
700	1.12	0.54	1.04	2.05	4.06	8.07	15.94	31.34
800	1.15	0.53	1.03	2.05	4.06	8.06	15.93	31.23
900	1.18	0.54	1.04	2.05	4.06	8.07	15.92	31.16
1000	1.20	0.53	1.03	2.05	4.06	8.07	15.93	31.14
1100	1.21	0.53	1.04	2.05	4.06	8.08	15.94	31.19
1200	1.23	0.53	1.03	2.05	4.06	8.08	15.96	31.32
1300	1.25	0.54	1.04	2.05	4.06	8.09	15.98	31.35
1400	1.27	0.54	1.04	2.05	4.07	8.11	16.02	31.47
1500	1.30	0.54	1.04	2.05	4.07	8.12	16.04	31.48
1600	1.32	0.54	1.05	2.05	4.07	8.13	16.07	31.50
1700	1.35	0.55	1.05	2.06	4.08	8.15	16.10	31.53
1800	1.36	0.55	1.06	2.07	4.09	8.17	16.12	31.50
1900	1.37	0.55	1.06	2.08	4.11	8.20	16.18	31.54
2000	1.38	0.56	1.07	2.09	4.13	8.24	16.23	31.57
2100	1.40	0.56	1.08	2.10	4.15	8.29	16.30	31.60
2200	1.42	0.57	1.09	2.12	4.17	8.34	16.36	31.54
2300	1.44	0.57	1.10	2.13	4.20	8.39	16.44	31.59
2400	1.45	0.58	1.11	2.15	4.23	8.45	16.53	31.71
2500	1.46	0.58	1.11	2.17	4.26	8.51	16.61	31.73
2600	1.48	0.58	1.12	2.18	4.28	8.57	16.69	31.71
2700	1.50	0.58	1.12	2.19	4.29	8.61	16.75	31.71
2800	1.52	0.58	1.11	2.19	4.29	8.63	16.78	31.57
2900	1.53	0.58	1.10	2.18	4.28	8.64	16.82	31.58
3000	1.53	0.57	1.09	2.16	4.26	8.64	16.82	31.47
3200	1.52	0.55	1.06	2.12	4.20	8.60	16.81	31.32
3400	1.55	0.54	1.03	2.08	4.15	8.55	16.74	30.70
3600	1.62	0.53	1.02	2.06	4.11	8.54	16.73	30.69
3800	1.70	0.53	1.02	2.05	4.10	8.55	16.75	30.42
4000	1.76	0.54	1.03	2.05	4.11	8.58	16.79	30.56
4200	1.77	0.54	1.04	2.07	4.13	8.65	16.94	30.90
4400	1.84	0.55	1.06	2.08	4.16	8.74	17.12	31.22
4600	1.89	0.57	1.08	2.12	4.22	8.91	17.49	31.88
4800	1.94	0.58	1.11	2.16	4.29	9.10	17.80	32.03
5000	1.97	0.59	1.11	2.20	4.38	9.33	18.25	32.07

* Step Attenuation above Thru Loss (TTL Logic 00000).

Digital Step Attenuator

DAT-31R5A-PN-2+

Typical Performance Data

TEST CONDITIONS: INPUT POWER=0 dBm, Vdd=+3V, Vss=-3.2V, TEMPERATURE=-40°C

FREQUENCY (MHz)	INPUT RETURN LOSS AT TTL CONTROL STATE							
	(dB)							
	000000 0 dB	000001 0.5 dB	000010 1.0 dB	000100 2.0 dB	001000 4.0 dB	010000 8.0 dB	100000 16 dB	111111 31.5 dB
0.1	18.70	20.45	22.20	20.39	21.81	26.16	38.97	30.72
0.3	18.80	20.55	22.31	20.47	21.89	26.27	38.82	30.69
0.5	18.80	20.56	22.31	20.48	21.90	26.27	38.72	30.70
1	18.94	20.69	22.48	20.59	22.01	26.36	38.57	30.65
5	18.96	20.72	22.49	20.62	22.04	26.39	38.60	30.67
10	18.94	20.70	22.47	20.61	22.01	26.36	38.83	30.73
50	18.79	20.48	22.20	20.36	21.70	25.77	41.37	31.90
100	18.66	20.29	21.89	20.09	21.28	24.94	48.61	34.24
200	18.49	20.08	21.64	19.98	21.22	24.98	42.33	32.95
300	18.80	20.50	22.19	20.52	21.99	26.46	37.70	30.23
400	18.73	20.46	22.19	20.52	22.06	26.69	37.35	30.37
500	18.07	19.69	21.29	19.80	21.27	25.47	39.41	32.49
600	17.94	19.49	21.01	19.53	20.86	24.68	43.99	35.00
700	17.92	19.43	20.87	19.38	20.62	24.32	46.66	36.16
800	17.63	19.05	20.41	19.00	20.20	23.67	42.47	36.79
900	17.38	18.71	19.95	18.67	19.83	23.21	38.20	33.50
1000	17.18	18.44	19.60	18.46	19.65	23.07	35.28	30.49
1100	17.06	18.27	19.37	18.32	19.51	22.96	33.39	28.73
1200	16.99	18.11	19.11	18.15	19.31	22.66	31.27	27.10
1300	16.84	17.87	18.76	17.97	19.15	22.46	28.95	25.13
1400	17.11	18.08	18.88	18.24	19.44	22.84	27.41	23.64
1500	17.22	18.11	18.83	18.36	19.64	23.14	26.57	22.85
1600	17.05	17.86	18.50	18.22	19.54	23.06	25.62	22.07
1700	16.78	17.51	18.07	18.00	19.38	22.83	24.38	21.12
1800	16.54	17.20	17.69	17.86	19.32	22.67	23.04	20.11
1900	16.46	17.08	17.51	17.88	19.43	22.55	21.73	19.13
2000	16.68	17.30	17.68	18.21	19.84	22.66	20.76	18.43
2100	16.95	17.57	17.92	18.58	20.26	22.67	19.97	17.87
2200	17.44	18.11	18.44	19.22	20.97	22.79	19.31	17.43
2300	18.14	18.92	19.26	20.16	22.03	23.02	18.77	17.10
2400	18.92	19.83	20.15	21.19	23.05	22.78	18.13	16.69
2500	20.05	21.17	21.46	22.64	24.27	22.24	17.42	16.19
2600	21.66	23.44	23.85	25.31	26.56	21.88	16.86	15.89
2700	23.19	26.74	28.39	30.19	30.56	21.69	16.55	15.82
2800	23.10	28.23	35.58	34.76	33.72	21.36	16.31	15.86
2900	22.00	26.36	32.67	30.42	30.45	20.85	16.11	15.89
3000	20.24	23.43	26.99	25.96	27.40	20.67	16.18	16.19
3200	17.62	19.74	21.82	21.32	23.25	20.50	16.63	17.23
3400	16.82	18.74	20.59	20.01	22.25	21.52	17.82	18.99
3600	17.70	19.78	21.80	20.74	23.30	23.76	19.45	21.01
3800	19.52	22.03	24.45	22.34	25.42	28.51	21.76	23.03
4000	23.23	25.84	27.13	24.79	27.87	34.56	23.01	21.36
4200	22.15	21.75	21.00	21.47	22.02	22.28	19.55	17.42
4400	18.02	17.21	16.55	17.36	17.27	16.71	15.33	13.97
4600	15.75	14.98	14.37	15.13	14.84	14.03	12.86	11.87
4800	14.99	14.07	13.38	14.03	13.42	12.20	11.03	10.36
5000	14.23	13.25	12.60	13.02	12.16	10.73	9.60	9.22

Digital Step Attenuator

DAT-31R5A-PN-2+

Typical Performance Data

TEST CONDITIONS: INPUT POWER=0 dBm, Vdd=+3V, Vss=-3.2V, TEMPERATURE=-40°C

FREQUENCY (MHz)	OUTPUT RETURN LOSS AT TTL CONTROL STATE							
	(dB)							
	000000 0 dB	000001 0.5 dB	000010 1.0 dB	000100 2.0 dB	001000 4.0 dB	010000 8.0 dB	100000 16 dB	111111 31.5 dB
0.1	18.39	19.16	19.48	25.13	30.34	39.65	34.63	30.00
0.3	18.47	19.24	19.56	25.21	30.48	39.92	34.75	29.93
0.5	18.52	19.29	19.62	25.30	30.56	39.93	34.84	29.97
1	18.64	19.41	19.73	25.45	30.77	40.43	35.11	29.87
5	18.77	19.53	19.84	25.61	30.97	40.70	35.17	29.91
10	18.77	19.54	19.84	25.61	30.97	40.60	35.01	29.94
50	18.79	19.54	19.82	25.50	30.55	39.10	34.12	30.58
100	18.72	19.42	19.68	25.06	29.51	36.03	32.19	32.28
200	18.53	19.23	19.50	24.59	28.56	33.91	31.69	30.98
300	18.55	19.30	19.62	24.86	29.01	34.58	33.55	28.74
400	19.16	19.96	20.27	26.06	30.66	36.28	36.09	27.49
500	19.90	20.71	21.02	27.51	32.92	40.21	40.24	27.33
600	20.10	20.82	21.06	27.37	32.31	41.13	37.40	28.53
700	20.00	20.67	20.86	26.61	30.36	36.38	34.81	28.65
800	20.30	20.87	21.00	26.42	29.45	34.55	34.04	28.29
900	20.16	20.68	20.79	25.64	28.11	32.71	33.08	27.85
1000	19.96	20.44	20.58	24.97	27.23	31.93	33.50	27.21
1100	19.70	20.18	20.35	24.58	26.89	32.09	34.09	27.23
1200	19.21	19.67	19.86	23.66	25.89	31.09	33.68	26.92
1300	18.65	19.13	19.37	22.90	25.17	30.65	34.25	26.59
1400	17.84	18.34	18.63	21.95	24.28	29.90	33.85	26.41
1500	17.14	17.63	17.94	21.01	23.23	28.47	32.62	25.71
1600	16.53	17.02	17.34	20.12	22.20	27.06	31.83	24.54
1700	15.90	16.38	16.74	19.24	21.18	25.70	30.83	23.26
1800	15.28	15.78	16.15	18.44	20.26	24.45	29.69	21.91
1900	14.90	15.42	15.83	17.97	19.69	23.59	28.62	20.77
2000	14.80	15.34	15.77	17.86	19.49	23.12	27.63	19.94
2100	14.79	15.36	15.80	17.85	19.36	22.65	26.41	19.20
2200	14.98	15.57	16.02	18.01	19.33	22.14	25.03	18.46
2300	15.42	16.05	16.50	18.45	19.50	21.68	23.65	17.78
2400	15.97	16.63	17.10	18.96	19.69	21.19	22.38	17.18
2500	16.76	17.50	17.99	19.80	20.05	20.75	21.21	16.66
2600	18.12	18.98	19.52	21.25	20.69	20.33	20.15	16.24
2700	19.93	21.07	21.71	23.43	21.55	20.00	19.28	15.95
2800	22.27	24.03	25.02	26.54	22.45	19.72	18.58	15.85
2900	23.55	26.16	27.92	30.17	23.36	19.63	18.16	15.96
3000	23.50	26.28	28.45	31.30	23.84	19.50	17.81	16.17
3200	21.33	23.14	24.36	26.81	23.97	19.59	17.64	17.00
3400	20.20	21.56	22.36	24.85	24.17	20.03	17.85	18.28
3600	20.15	21.33	21.90	25.46	25.86	21.19	18.53	20.18
3800	20.74	21.74	22.07	28.34	30.53	23.55	19.95	22.83
4000	21.34	21.97	22.11	31.13	39.69	28.84	22.61	24.83
4200	20.29	20.68	20.88	25.84	27.92	34.08	24.96	22.41
4400	18.90	19.28	19.59	22.38	23.38	27.62	23.92	19.46
4600	19.17	19.62	19.99	21.41	21.45	22.65	20.30	17.12
4800	20.99	21.71	22.23	22.37	21.07	19.86	17.46	15.70
5000	26.13	28.15	29.11	24.65	20.99	17.71	15.34	14.73

Digital Step Attenuator

DAT-31R5A-PN-2+

Typical Performance Data

TEST CONDITIONS: INPUT POWER=0 dBm, Vdd=+3V, Vss=-3.2V, TEMPERATURE=+25°C

FREQUENCY (MHz)	STEP ATTENUATION* AT TTL CONTROL STATE (dB)							
	000000 THRU LOSS	000001 0.5 dB	000010 1.0 dB	000100 2.0 dB	001000 4.0 dB	010000 8.0 dB	100000 16 dB	111111 31.5 dB
0.1	1.13	0.52	1.02	2.01	4.01	7.95	15.86	31.31
0.3	1.12	0.52	1.02	2.02	4.01	7.95	15.86	31.33
0.5	1.12	0.52	1.02	2.01	4.01	7.95	15.86	31.31
1	1.12	0.52	1.02	2.01	4.00	7.95	15.85	31.30
5	1.15	0.52	1.02	2.01	4.01	7.95	15.86	31.32
10	1.15	0.52	1.02	2.01	4.01	7.95	15.86	31.33
50	1.16	0.52	1.02	2.01	4.01	7.95	15.86	31.32
100	1.16	0.52	1.02	2.01	4.00	7.95	15.86	31.32
200	1.16	0.52	1.02	2.01	4.01	7.95	15.86	31.31
300	1.17	0.52	1.02	2.01	4.01	7.95	15.87	31.30
400	1.18	0.52	1.02	2.01	4.00	7.95	15.86	31.29
500	1.19	0.52	1.01	2.01	4.00	7.95	15.87	31.28
600	1.21	0.52	1.01	2.01	4.00	7.95	15.86	31.23
700	1.22	0.52	1.01	2.01	4.00	7.96	15.86	31.17
800	1.24	0.52	1.01	2.01	4.00	7.96	15.85	31.09
900	1.26	0.52	1.01	2.01	4.00	7.96	15.85	31.03
1000	1.29	0.52	1.01	2.01	4.00	7.96	15.85	30.99
1100	1.31	0.52	1.01	2.01	4.00	7.96	15.86	31.03
1200	1.34	0.52	1.01	2.01	4.00	7.96	15.87	31.09
1300	1.36	0.52	1.01	2.00	3.99	7.97	15.88	31.15
1400	1.38	0.52	1.01	2.00	3.99	7.97	15.90	31.21
1500	1.41	0.52	1.01	2.00	3.99	7.98	15.92	31.27
1600	1.43	0.52	1.02	2.01	3.99	7.98	15.94	31.31
1700	1.46	0.53	1.02	2.01	4.00	8.00	15.97	31.35
1800	1.48	0.53	1.03	2.01	4.01	8.02	16.00	31.37
1900	1.50	0.53	1.03	2.02	4.02	8.04	16.04	31.42
2000	1.51	0.54	1.04	2.04	4.04	8.08	16.09	31.45
2100	1.53	0.54	1.05	2.05	4.06	8.13	16.16	31.47
2200	1.55	0.55	1.06	2.07	4.09	8.18	16.24	31.56
2300	1.56	0.55	1.06	2.09	4.12	8.24	16.32	31.60
2400	1.57	0.55	1.07	2.11	4.15	8.30	16.41	31.65
2500	1.58	0.56	1.08	2.12	4.17	8.36	16.50	31.71
2600	1.60	0.56	1.08	2.13	4.19	8.41	16.57	31.72
2700	1.62	0.56	1.07	2.13	4.19	8.44	16.63	31.74
2800	1.64	0.55	1.07	2.13	4.19	8.46	16.68	31.74
2900	1.65	0.55	1.06	2.11	4.17	8.47	16.71	31.68
3000	1.66	0.54	1.04	2.10	4.15	8.47	16.72	31.61
3200	1.64	0.53	1.02	2.06	4.10	8.44	16.72	31.36
3400	1.68	0.51	1.00	2.03	4.05	8.42	16.72	31.28
3600	1.75	0.51	0.99	2.01	4.03	8.42	16.73	31.07
3800	1.83	0.51	1.00	2.01	4.03	8.43	16.74	30.93
4000	1.88	0.52	1.01	2.02	4.04	8.46	16.79	30.99
4200	1.91	0.53	1.02	2.03	4.05	8.52	16.91	31.30
4400	1.99	0.54	1.03	2.05	4.09	8.63	17.16	32.01
4600	2.03	0.55	1.06	2.09	4.15	8.80	17.53	32.69
4800	2.07	0.57	1.08	2.13	4.23	9.01	17.94	33.18
5000	2.13	0.57	1.08	2.18	4.31	9.26	18.47	33.37

* Step Attenuation above Thru Loss (TTL Logic 00000).

Digital Step Attenuator

DAT-31R5A-PN-2+

Typical Performance Data

TEST CONDITIONS: INPUT POWER=0 dBm, Vdd=+3V, Vss=-3.2V, TEMPERATURE=+25°C

FREQUENCY (MHz)	INPUT RETURN LOSS AT TTL CONTROL STATE							
	(dB)							
	000000 0 dB	000001 0.5 dB	000010 1.0 dB	000100 2.0 dB	001000 4.0 dB	010000 8.0 dB	100000 16 dB	111111 31.5 dB
0.1	17.82	19.06	20.23	18.29	18.75	20.59	28.02	33.40
0.3	17.91	19.15	20.29	18.36	18.81	20.65	28.07	33.48
0.5	17.92	19.15	20.30	18.35	18.82	20.63	28.03	33.42
1	18.04	19.27	20.44	18.45	18.90	20.70	28.10	33.51
5	18.05	19.29	20.45	18.47	18.92	20.72	28.13	33.48
10	18.04	19.28	20.43	18.47	18.90	20.71	28.06	33.41
50	17.97	19.19	20.33	18.40	18.83	20.62	27.79	32.90
100	18.00	19.21	20.36	18.42	18.85	20.62	27.72	32.77
200	17.83	19.01	20.14	18.26	18.71	20.45	27.23	31.96
300	17.74	18.90	20.00	18.15	18.58	20.26	26.67	31.08
400	17.64	18.77	19.83	18.01	18.40	20.01	26.03	30.08
500	17.41	18.51	19.52	17.78	18.16	19.71	25.37	29.19
600	17.25	18.32	19.29	17.57	17.92	19.44	24.78	28.21
700	17.07	18.08	19.01	17.34	17.68	19.10	24.13	27.18
800	16.96	17.93	18.82	17.18	17.47	18.86	23.66	26.27
900	16.83	17.75	18.57	17.00	17.28	18.64	23.29	25.51
1000	16.76	17.64	18.40	16.90	17.17	18.55	23.11	24.87
1100	16.70	17.50	18.20	16.82	17.10	18.51	23.01	24.30
1200	16.64	17.39	18.02	16.77	17.06	18.51	22.95	23.71
1300	16.45	17.12	17.68	16.62	16.99	18.52	22.91	23.13
1400	16.20	16.79	17.29	16.49	16.95	18.62	22.96	22.57
1500	15.93	16.46	16.90	16.37	16.96	18.82	23.13	22.10
1600	15.72	16.21	16.61	16.34	17.09	19.19	23.46	21.76
1700	15.50	15.96	16.33	16.31	17.23	19.62	23.80	21.44
1800	15.29	15.73	16.08	16.29	17.39	20.09	23.96	21.06
1900	15.15	15.58	15.91	16.33	17.60	20.61	23.86	20.61
2000	15.21	15.64	15.95	16.57	18.01	21.33	23.58	20.17
2100	15.52	15.98	16.27	17.06	18.70	22.33	23.15	19.77
2200	16.11	16.62	16.90	17.86	19.74	23.67	22.74	19.54
2300	16.90	17.49	17.78	18.90	21.04	25.12	22.19	19.34
2400	17.95	18.69	19.01	20.30	22.82	26.51	21.47	19.11
2500	19.44	20.51	20.92	22.40	25.62	27.55	20.72	18.90
2600	21.21	22.99	23.80	25.41	30.69	27.35	19.94	18.70
2700	22.39	25.44	27.76	28.42	43.15	26.12	19.34	18.69
2800	21.86	25.40	29.73	27.59	33.58	24.60	18.92	18.84
2900	20.56	23.55	27.18	24.85	27.74	23.39	18.71	19.17
3000	19.14	21.55	24.23	22.45	24.47	22.27	18.54	19.51
3200	17.03	18.79	20.57	19.35	20.81	20.50	18.29	20.34
3400	16.23	17.78	19.26	18.04	19.34	20.16	19.07	22.77
3600	17.08	18.69	20.17	18.51	19.71	21.35	20.95	27.05
3800	18.95	20.62	21.89	19.80	20.98	24.26	25.32	45.52
4000	20.43	21.16	21.24	20.60	21.87	28.31	41.13	25.50
4200	18.70	18.40	17.94	18.86	19.83	22.71	23.15	18.89
4400	15.94	15.47	15.00	16.13	16.62	17.34	16.91	14.80
4600	14.45	13.91	13.41	14.44	14.53	14.37	13.65	12.38
4800	14.01	13.29	12.71	13.54	13.20	12.33	11.42	10.69
5000	13.84	13.00	12.42	12.97	12.30	11.07	10.06	9.67

Digital Step Attenuator

DAT-31R5A-PN-2+

Typical Performance Data

TEST CONDITIONS: INPUT POWER=0 dBm, Vdd=+3V, Vss=-3.2V, TEMPERATURE=+25°C

FREQUENCY (MHz)	OUTPUT RETURN LOSS AT TTL CONTROL STATE							
	(dB)							
	000000 0 dB	000001 0.5 dB	000010 1.0 dB	000100 2.0 dB	001000 4.0 dB	010000 8.0 dB	100000 16 dB	111111 31.5 dB
0.1	17.58	17.99	18.02	21.83	23.91	25.36	23.11	35.67
0.3	17.65	18.05	18.09	21.91	23.98	25.40	23.16	35.72
0.5	17.71	18.11	18.14	21.96	24.02	25.41	23.14	35.68
1	17.83	18.23	18.24	22.09	24.11	25.47	23.20	35.82
5	17.94	18.33	18.34	22.18	24.19	25.53	23.22	35.80
10	17.94	18.33	18.34	22.18	24.18	25.53	23.23	35.69
50	17.88	18.27	18.29	22.09	24.05	25.38	23.13	35.07
100	17.90	18.29	18.30	22.07	23.99	25.30	23.09	34.64
200	18.05	18.43	18.44	22.20	24.09	25.36	23.12	34.21
300	18.30	18.68	18.65	22.47	24.31	25.51	23.23	33.90
400	18.72	19.07	19.02	22.91	24.66	25.72	23.35	33.48
500	19.03	19.36	19.27	23.20	24.84	25.83	23.40	32.92
600	19.49	19.75	19.62	23.59	25.08	25.90	23.36	32.23
700	19.78	20.02	19.83	23.76	25.06	25.73	23.21	31.37
800	19.99	20.14	19.91	23.72	24.82	25.38	22.89	30.25
900	19.83	19.97	19.73	23.30	24.28	24.85	22.50	29.13
1000	19.45	19.53	19.33	22.61	23.52	24.17	22.03	27.90
1100	18.82	18.94	18.77	21.73	22.66	23.49	21.62	26.70
1200	18.18	18.28	18.17	20.84	21.78	22.84	21.29	25.52
1300	17.43	17.55	17.52	19.91	20.91	22.23	21.05	24.43
1400	16.60	16.77	16.80	18.95	20.02	21.66	20.94	23.40
1500	15.77	15.97	16.08	18.03	19.17	21.12	20.91	22.44
1600	15.04	15.29	15.45	17.23	18.45	20.71	21.07	21.59
1700	14.46	14.74	14.95	16.60	17.85	20.38	21.35	20.80
1800	14.01	14.32	14.57	16.11	17.39	20.18	21.83	20.12
1900	13.67	14.01	14.28	15.74	17.03	20.04	22.43	19.47
2000	13.51	13.88	14.18	15.57	16.85	20.05	23.17	18.93
2100	13.57	13.97	14.30	15.63	16.88	20.20	24.02	18.45
2200	13.92	14.34	14.68	15.95	17.14	20.48	24.76	18.05
2300	14.55	15.00	15.35	16.56	17.62	20.91	25.29	17.74
2400	15.44	15.92	16.28	17.43	18.30	21.36	25.17	17.49
2500	16.68	17.22	17.60	18.70	19.28	21.88	24.58	17.36
2600	18.43	19.07	19.48	20.57	20.62	22.39	23.66	17.34
2700	20.61	21.49	21.98	23.18	22.31	22.78	22.63	17.44
2800	23.11	24.51	25.25	26.96	24.23	22.91	21.61	17.67
2900	24.57	26.67	27.88	32.25	26.05	22.78	20.73	18.03
3000	23.90	25.93	27.13	35.65	27.45	22.57	20.04	18.58
3200	20.68	21.89	22.54	27.66	27.49	22.10	19.13	20.31
3400	19.20	20.09	20.46	24.98	26.80	22.21	18.97	23.37
3600	19.30	19.98	20.10	25.26	27.53	23.27	19.62	29.19
3800	20.31	20.67	20.53	26.23	27.89	25.71	21.39	35.49
4000	20.01	20.03	19.91	23.47	24.46	29.11	25.04	26.21
4200	18.22	18.27	18.37	20.14	21.10	29.17	33.85	21.39
4400	17.20	17.36	17.61	18.44	19.28	25.89	31.08	18.54
4600	17.63	17.89	18.23	18.27	18.78	22.98	22.79	16.78
4800	20.08	20.53	20.93	19.84	19.56	20.86	18.74	15.83
5000	27.64	29.04	29.62	23.23	20.95	18.85	16.13	15.38

Digital Step Attenuator

DAT-31R5A-PN-2+

Typical Performance Data

TEST CONDITIONS: INPUT POWER=0 dBm, Vdd=+3V, Vss=-3.2V, TEMPERATURE=+105°C

FREQUENCY (MHz)	STEP ATTENUATION* AT TTL CONTROL STATE (dB)							
	000000 THRU LOSS	000001 0.5 dB	000010 1.0 dB	000100 2.0 dB	001000 4.0 dB	010000 8.0 dB	100000 16 dB	111111 31.5 dB
0.1	1.30	0.51	0.99	1.98	3.95	7.85	15.75	31.03
0.3	1.28	0.50	0.99	1.97	3.95	7.84	15.75	31.04
0.5	1.28	0.50	0.99	1.97	3.95	7.84	15.75	31.03
1	1.29	0.50	0.99	1.97	3.95	7.84	15.75	31.02
5	1.31	0.50	0.99	1.98	3.95	7.85	15.76	31.04
10	1.31	0.51	0.99	1.98	3.95	7.84	15.76	31.04
50	1.32	0.50	0.99	1.97	3.95	7.84	15.76	31.05
100	1.30	0.51	0.99	1.98	3.95	7.85	15.76	31.05
200	1.31	0.50	0.99	1.98	3.95	7.85	15.76	31.05
300	1.33	0.50	0.99	1.98	3.95	7.85	15.76	31.03
400	1.35	0.50	0.98	1.97	3.95	7.85	15.76	31.02
500	1.37	0.50	0.98	1.97	3.95	7.85	15.77	31.01
600	1.39	0.50	0.99	1.98	3.95	7.86	15.77	30.99
700	1.41	0.50	0.98	1.98	3.96	7.86	15.77	30.95
800	1.44	0.50	0.98	1.98	3.96	7.87	15.77	30.90
900	1.46	0.50	0.98	1.98	3.96	7.87	15.77	30.85
1000	1.49	0.50	0.98	1.98	3.96	7.87	15.77	30.83
1100	1.51	0.50	0.98	1.97	3.95	7.87	15.77	30.87
1200	1.54	0.50	0.99	1.98	3.95	7.87	15.78	30.91
1300	1.57	0.50	0.99	1.98	3.95	7.87	15.78	30.95
1400	1.59	0.50	0.99	1.98	3.94	7.87	15.80	31.04
1500	1.62	0.50	0.99	1.98	3.94	7.86	15.81	31.11
1600	1.65	0.50	0.99	1.97	3.93	7.87	15.82	31.14
1700	1.67	0.51	0.99	1.97	3.93	7.87	15.84	31.18
1800	1.70	0.51	1.00	1.98	3.93	7.89	15.87	31.29
1900	1.72	0.51	1.00	1.98	3.94	7.90	15.90	31.31
2000	1.73	0.51	1.01	1.99	3.95	7.93	15.94	31.33
2100	1.75	0.52	1.01	2.00	3.97	7.96	16.00	31.41
2200	1.77	0.52	1.02	2.01	3.99	8.00	16.06	31.47
2300	1.78	0.52	1.02	2.03	4.01	8.05	16.14	31.56
2400	1.79	0.53	1.03	2.04	4.03	8.10	16.22	31.62
2500	1.80	0.53	1.03	2.05	4.05	8.16	16.31	31.73
2600	1.82	0.53	1.03	2.06	4.07	8.20	16.38	31.79
2700	1.84	0.52	1.02	2.06	4.07	8.24	16.44	31.72
2800	1.86	0.52	1.02	2.06	4.07	8.27	16.51	31.81
2900	1.87	0.52	1.01	2.05	4.06	8.29	16.57	31.88
3000	1.87	0.51	1.00	2.04	4.05	8.30	16.60	31.88
3200	1.85	0.50	0.98	2.01	4.01	8.31	16.66	31.71
3400	1.90	0.49	0.96	1.99	3.98	8.30	16.67	31.63
3600	1.96	0.49	0.96	1.98	3.96	8.32	16.73	31.59
3800	2.04	0.49	0.97	1.98	3.96	8.34	16.75	31.40
4000	2.12	0.51	0.99	1.99	3.96	8.36	16.79	31.47
4200	2.18	0.51	0.99	1.99	3.96	8.39	16.88	32.09
4400	2.24	0.50	0.99	1.99	3.97	8.46	17.09	32.54
4600	2.28	0.51	1.01	2.02	4.01	8.59	17.38	33.26
4800	2.31	0.55	1.05	2.09	4.11	8.83	17.88	34.23
5000	2.39	0.56	1.05	2.15	4.22	9.13	18.55	34.45

* Step Attenuation above Thru Loss (TTL Logic 00000).

Digital Step Attenuator

DAT-31R5A-PN-2+

Typical Performance Data

TEST CONDITIONS: INPUT POWER=0 dBm, Vdd=+3V, Vss=-3.2V, TEMPERATURE=+105°C

FREQUENCY (MHz)	INPUT RETURN LOSS AT TTL CONTROL STATE							
	(dB)							
	000000 0 dB	000001 0.5 dB	000010 1.0 dB	000100 2.0 dB	001000 4.0 dB	010000 8.0 dB	100000 16 dB	111111 31.5 dB
0.1	16.58	17.34	17.99	16.00	15.78	16.37	19.55	21.34
0.3	16.65	17.41	18.06	16.07	15.83	16.40	19.56	21.36
0.5	16.64	17.40	18.05	16.06	15.83	16.39	19.54	21.33
1	16.75	17.49	18.16	16.13	15.87	16.41	19.57	21.34
5	16.79	17.53	18.18	16.15	15.89	16.44	19.59	21.36
10	16.78	17.53	18.17	16.16	15.91	16.45	19.59	21.38
50	16.84	17.61	18.27	16.27	16.03	16.59	19.77	21.59
100	17.07	17.86	18.55	16.49	16.26	16.88	20.21	22.13
200	16.82	17.61	18.31	16.35	16.17	16.81	20.04	21.94
300	16.27	16.97	17.59	15.76	15.55	16.06	18.84	20.49
400	16.26	16.91	17.48	15.62	15.32	15.72	18.29	19.82
500	16.35	16.97	17.52	15.62	15.27	15.58	18.04	19.53
600	16.17	16.76	17.24	15.37	15.00	15.29	17.58	18.98
700	15.88	16.41	16.86	15.06	14.67	14.91	17.07	18.36
800	15.83	16.33	16.74	14.94	14.53	14.75	16.82	17.98
900	15.75	16.22	16.60	14.89	14.47	14.68	16.70	17.79
1000	15.61	16.02	16.36	14.76	14.38	14.64	16.65	17.62
1100	15.35	15.76	16.06	14.65	14.32	14.64	16.64	17.49
1200	15.25	15.60	15.89	14.63	14.37	14.76	16.82	17.52
1300	15.07	15.40	15.67	14.62	14.45	14.95	17.09	17.65
1400	14.83	15.14	15.40	14.57	14.53	15.18	17.41	17.77
1500	14.57	14.88	15.12	14.54	14.65	15.47	17.83	17.96
1600	14.42	14.73	14.96	14.60	14.86	15.88	18.43	18.29
1700	14.32	14.63	14.85	14.71	15.12	16.39	19.15	18.68
1800	14.32	14.64	14.86	14.91	15.49	17.04	20.08	19.20
1900	14.37	14.69	14.91	15.16	15.92	17.82	21.21	19.76
2000	14.53	14.86	15.07	15.50	16.46	18.75	22.55	20.35
2100	14.82	15.17	15.38	15.99	17.14	19.93	24.23	21.02
2200	15.30	15.69	15.89	16.65	18.02	21.43	26.34	21.78
2300	16.01	16.45	16.65	17.57	19.19	23.48	28.88	22.58
2400	16.99	17.51	17.73	18.79	20.76	26.52	31.02	23.37
2500	18.17	18.86	19.14	20.26	22.66	31.02	30.70	24.09
2600	19.43	20.45	20.90	21.87	24.82	38.20	28.43	24.75
2700	20.67	22.23	23.14	23.42	26.75	34.13	25.82	25.06
2800	21.18	23.36	25.18	23.90	26.63	27.86	23.42	24.82
2900	20.66	22.99	25.40	22.87	24.55	24.47	21.81	24.46
3000	19.44	21.49	23.71	21.17	22.30	22.27	20.72	24.28
3200	17.04	18.54	20.10	18.21	18.96	19.37	19.11	23.66
3400	15.92	17.19	18.41	16.73	17.30	17.99	18.41	23.32
3600	16.01	17.15	18.12	16.41	16.82	17.83	18.88	23.77
3800	16.99	17.91	18.50	16.93	17.22	18.67	20.51	23.98
4000	18.08	18.37	18.28	17.82	18.26	20.79	24.76	22.71
4200	16.70	16.42	16.00	16.93	17.70	20.55	24.11	18.77
4400	14.71	14.39	13.96	15.33	16.08	17.73	18.57	15.48
4600	13.10	12.77	12.36	13.64	14.10	14.64	14.51	12.81
4800	12.97	12.43	11.95	13.05	13.10	12.76	12.15	11.23
5000	12.89	12.23	11.75	12.47	12.12	11.21	10.38	9.99

Digital Step Attenuator

DAT-31R5A-PN-2+

Typical Performance Data

TEST CONDITIONS: INPUT POWER=0 dBm, Vdd=+3V, Vss=-3.2V, TEMPERATURE=+105°C

FREQUENCY (MHz)	OUTPUT RETURN LOSS AT TTL CONTROL STATE							
	(dB)							
	000000 0 dB	000001 0.5 dB	000010 1.0 dB	000100 2.0 dB	001000 4.0 dB	010000 8.0 dB	100000 16 dB	111111 31.5 dB
0.1	16.36	16.43	16.22	18.64	19.14	18.98	17.26	21.98
0.3	16.41	16.48	16.27	18.69	19.18	19.02	17.28	21.99
0.5	16.44	16.51	16.30	18.72	19.20	19.02	17.28	21.96
1	16.54	16.60	16.37	18.80	19.25	19.05	17.31	21.97
5	16.65	16.70	16.45	18.87	19.30	19.06	17.32	21.99
10	16.65	16.70	16.46	18.87	19.30	19.08	17.32	21.99
50	16.68	16.75	16.54	18.98	19.45	19.28	17.53	22.28
100	16.75	16.83	16.62	19.12	19.66	19.54	17.79	22.68
200	17.01	17.11	16.89	19.46	20.01	19.86	18.04	23.13
300	17.24	17.29	17.02	19.49	19.85	19.49	17.65	22.43
400	17.35	17.33	17.01	19.34	19.50	18.98	17.16	21.56
500	17.38	17.32	16.95	19.21	19.24	18.64	16.87	20.97
600	17.83	17.69	17.29	19.47	19.33	18.60	16.79	20.73
700	18.15	17.95	17.46	19.60	19.30	18.45	16.63	20.35
800	18.17	17.90	17.40	19.34	18.95	18.09	16.31	19.76
900	17.88	17.61	17.12	18.95	18.56	17.77	16.11	19.23
1000	17.51	17.26	16.82	18.47	18.14	17.50	15.94	18.81
1100	16.95	16.74	16.38	17.92	17.72	17.28	15.86	18.45
1200	16.34	16.19	15.90	17.31	17.26	17.06	15.81	18.13
1300	15.65	15.57	15.37	16.69	16.81	16.87	15.82	17.84
1400	14.99	14.97	14.86	16.09	16.37	16.72	15.91	17.57
1500	14.40	14.44	14.39	15.56	15.98	16.62	16.08	17.34
1600	13.92	14.01	14.03	15.14	15.69	16.64	16.38	17.22
1700	13.51	13.64	13.71	14.77	15.43	16.67	16.74	17.09
1800	13.20	13.36	13.48	14.50	15.24	16.78	17.22	17.00
1900	13.01	13.20	13.35	14.33	15.14	16.98	17.85	16.93
2000	12.98	13.20	13.38	14.30	15.16	17.31	18.68	16.92
2100	13.12	13.35	13.56	14.44	15.33	17.79	19.77	16.97
2200	13.47	13.73	13.94	14.77	15.67	18.46	21.18	17.08
2300	14.04	14.32	14.55	15.31	16.20	19.35	23.06	17.26
2400	14.89	15.18	15.42	16.11	16.96	20.51	25.61	17.52
2500	16.06	16.36	16.61	17.24	18.00	22.03	29.20	17.92
2600	17.61	17.94	18.18	18.75	19.39	24.00	33.89	18.42
2700	19.42	19.81	20.04	20.70	21.13	26.40	34.25	19.00
2800	21.55	22.07	22.31	23.39	23.48	29.41	29.88	19.78
2900	23.25	24.02	24.29	26.91	26.50	31.86	26.53	20.69
3000	23.99	25.02	25.28	32.82	31.23	31.37	24.03	21.84
3200	21.77	22.60	22.77	33.72	41.34	26.70	20.99	25.41
3400	19.95	20.50	20.50	27.03	29.09	23.85	19.49	33.43
3600	19.68	19.95	19.72	24.98	25.39	22.54	19.05	35.85
3800	20.00	19.91	19.50	23.31	22.96	22.20	19.59	26.08
4000	19.11	18.86	18.58	20.49	20.44	22.21	21.29	21.66
4200	17.13	17.05	17.07	17.87	18.30	22.20	24.83	19.09
4400	15.92	15.97	16.16	16.44	17.09	22.26	32.14	17.47
4600	15.84	15.99	16.30	16.11	16.81	22.61	31.68	16.49
4800	17.57	17.92	18.29	17.39	17.84	23.00	23.08	16.06
5000	22.86	23.47	23.90	20.57	20.14	21.83	18.65	16.02

Digital Step Attenuator

Typical Performance Curves

DAT-31R5A-PN-2+

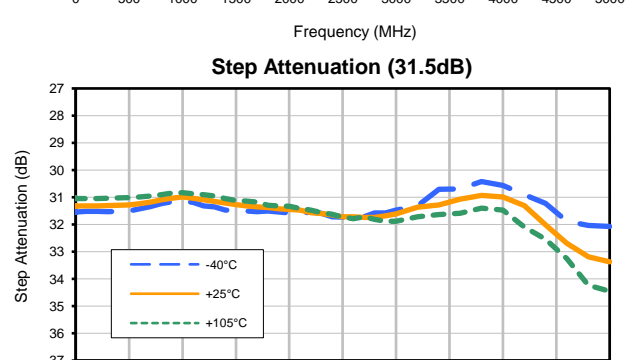
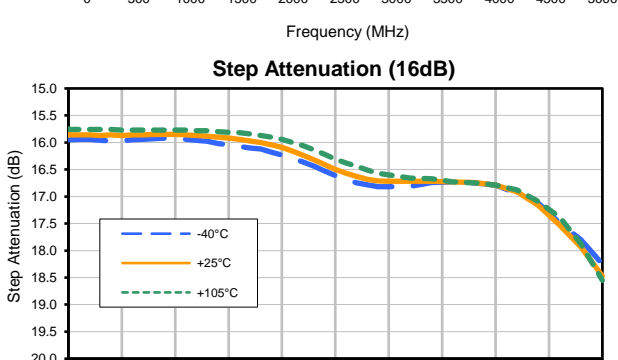
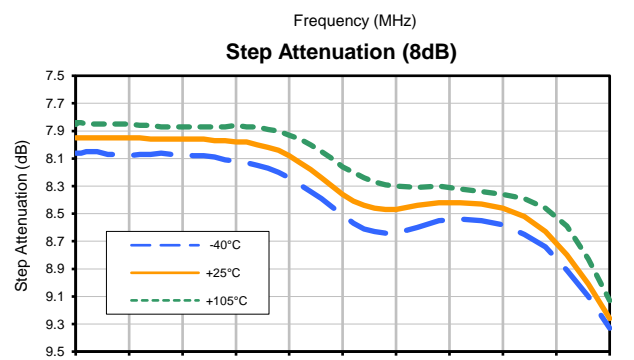
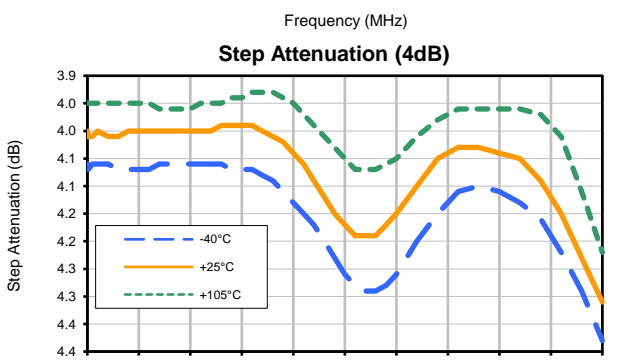
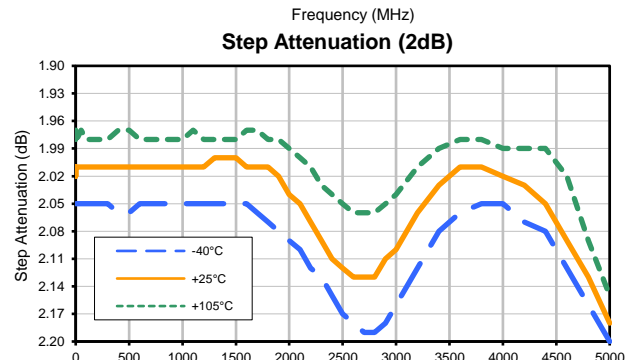
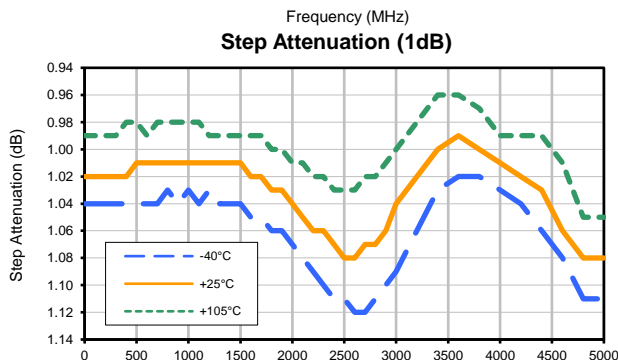
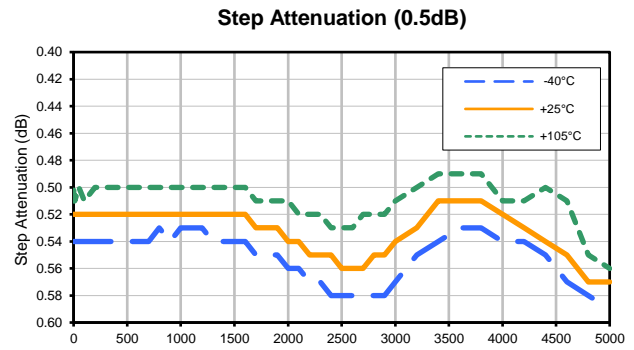
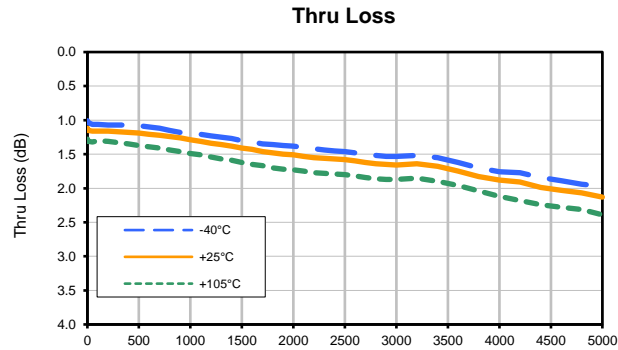

P.O. Box 350166, Brooklyn, New York 11235-0003 (718) 934-4500 • Fax (718) 332-4661 For detailed performance specs & shopping online see Mini-Circuits web site



The Design Engineers Search Engine Provides ACTUAL Data Instantly From MINI-CIRCUITS At: www.minicircuits.com

IF/RF MICROWAVE COMPONENTS

REV. OR
DAT-31R5A-PN-2+
9/13/2021
Page 1 of 3

Digital Step Attenuator

Typical Performance Curves

DAT-31R5A-PN-2+

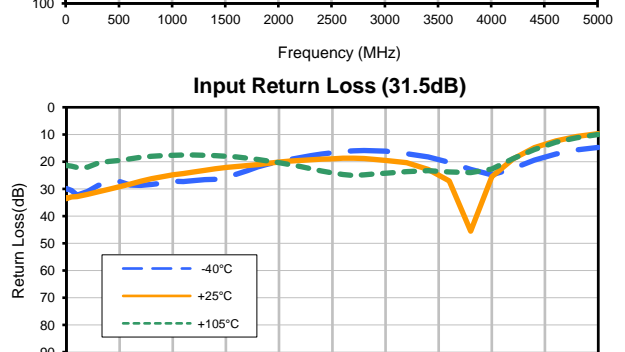
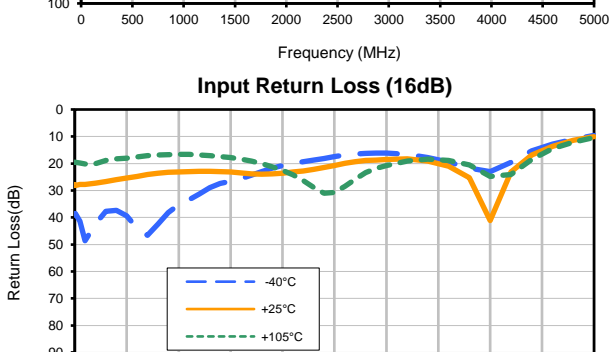
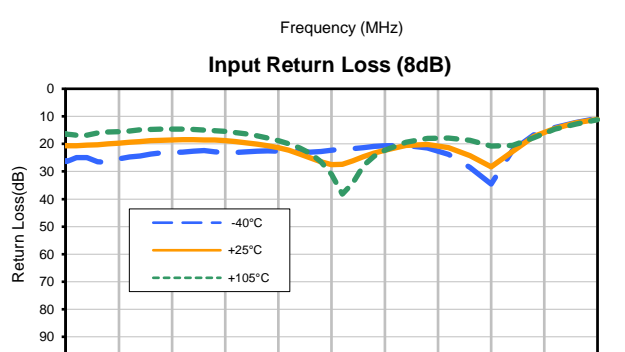
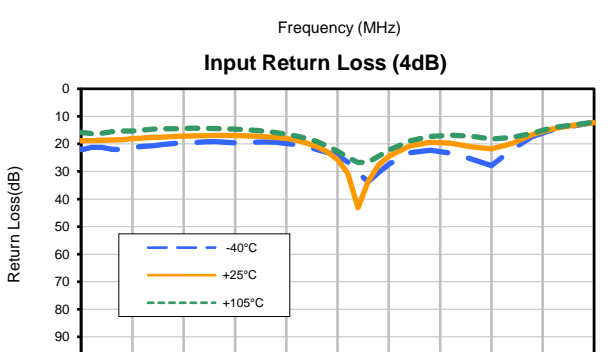
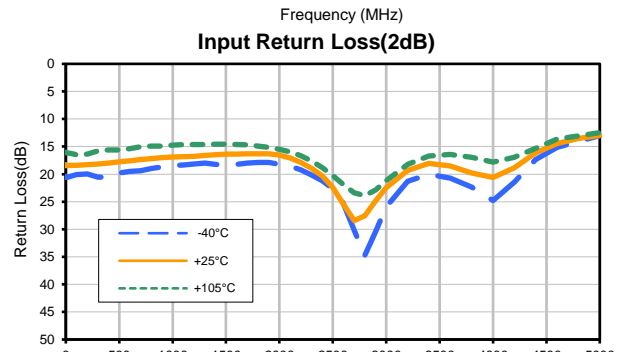
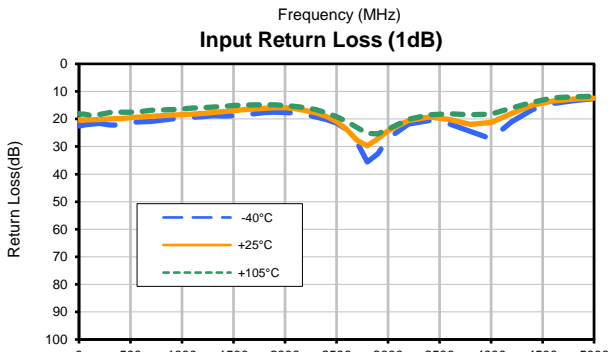
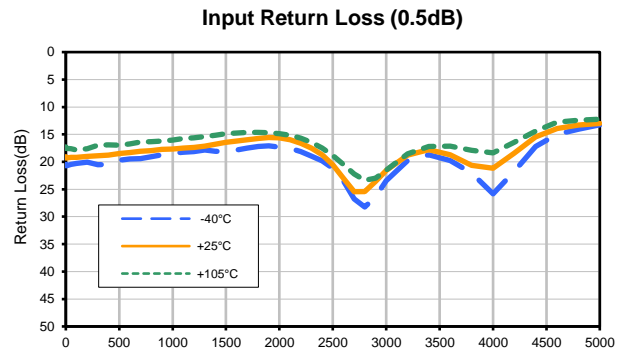
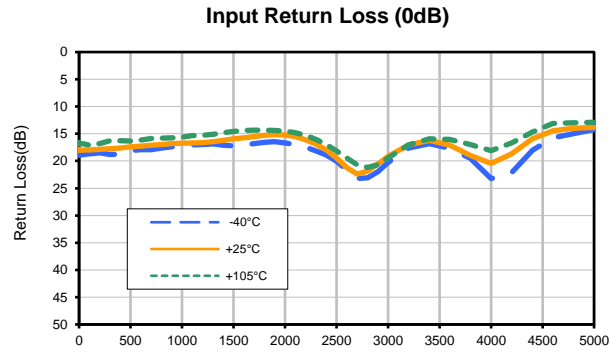

Digital Step Attenuator

Typical Performance Curves

DAT-31R5A-PN-2+

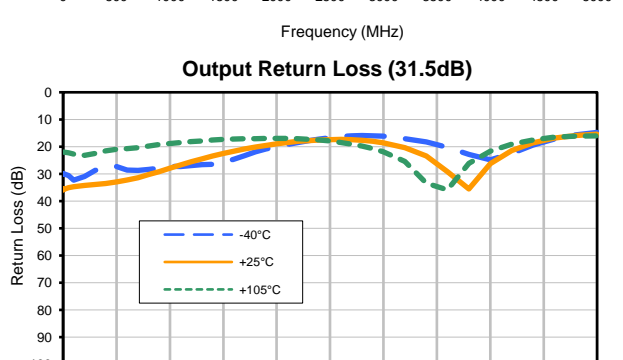
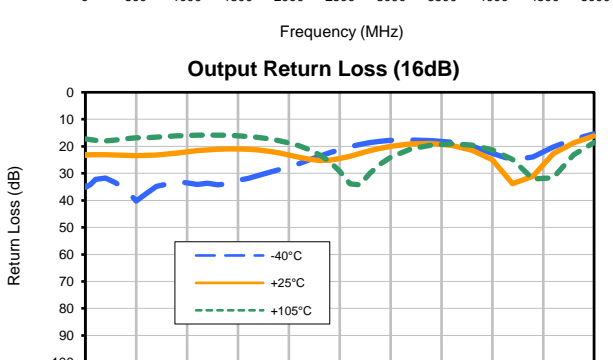
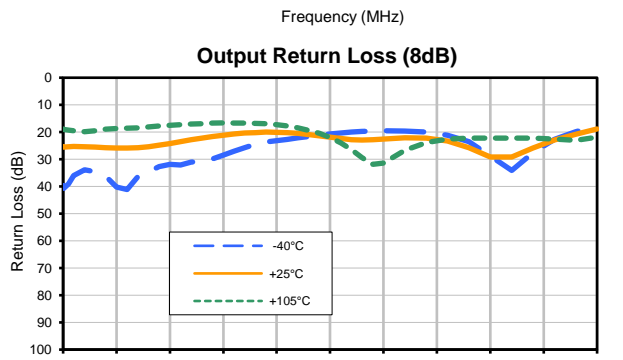
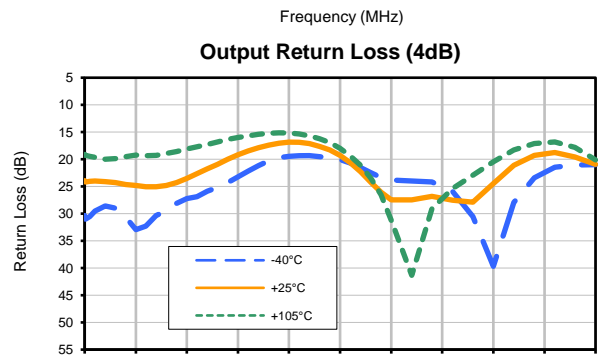
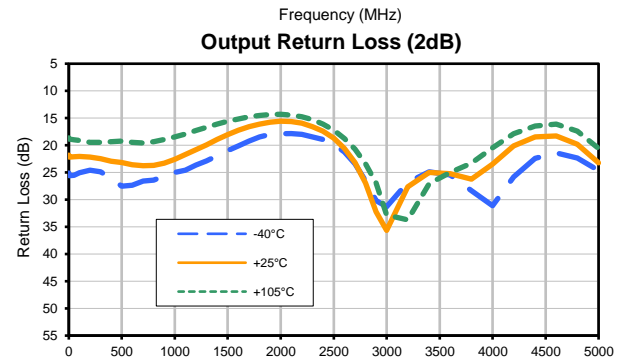
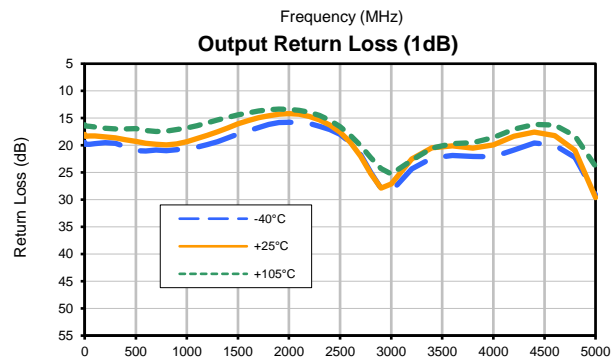
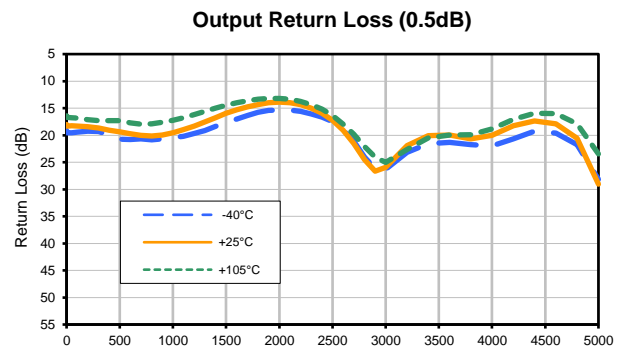
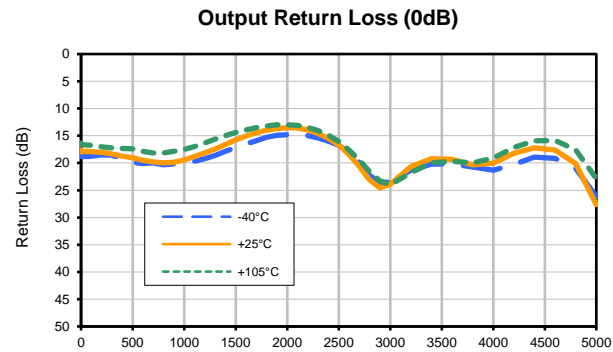

Outline Dimensions

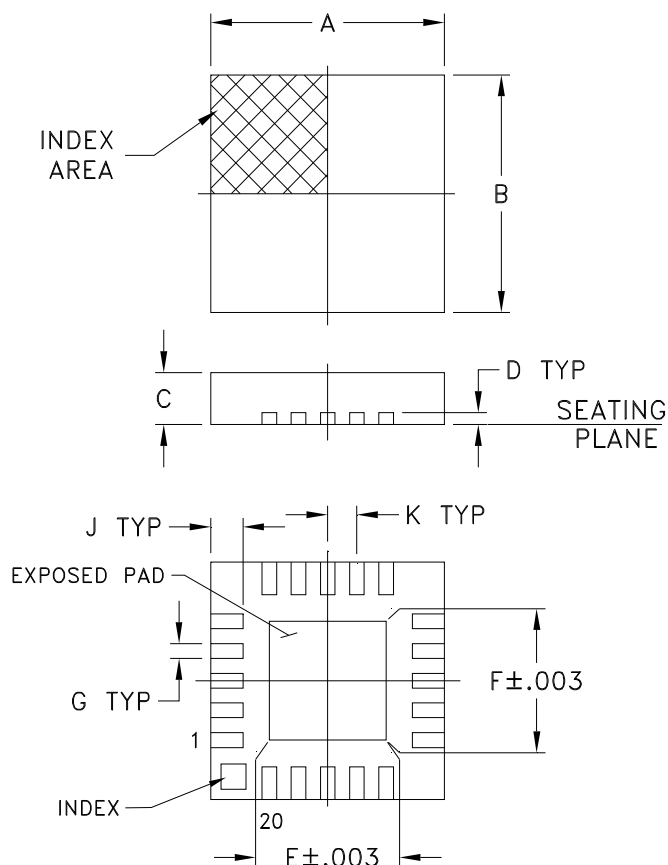

PCB Land Pattern

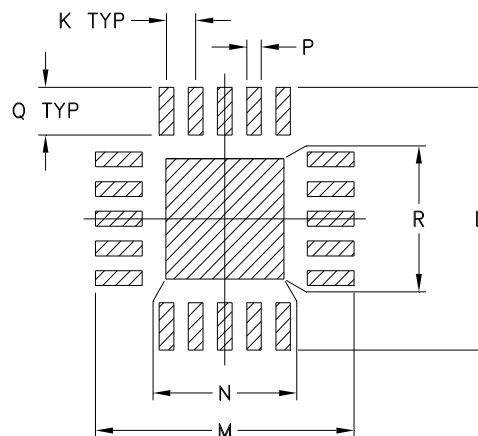

Suggested Layout,
Tolerance to be within $\pm .002$

CASE #	A	B	C	D	E	F	G	H	J	K
DG983-2	.157 (4.00)	.157 (4.00)	.033 (0.85)	.008 (0.20)	.085 (2.15)	.085 (2.15)	.009 (0.23)	-- --	.022 (0.55)	.020 (0.50)

CASE #	L	M	N	P	Q	R	WT. GRAM
DG983-2	.177 (4.50)	.177 (4.50)	.081 (2.06)	.010 (0.25)	.032 (0.81)	.081 (2.06)	.04

Dimensions are in inches (mm). Tolerances: 2 Pl. $\pm .01$; 3 Pl. $\pm .005$

Notes:

1. Case material: Plastic.
2. Termination finish:

For RoHS Case Styles: 0.2 μ inches of Gold (Au) over 0.1 μ inches of Palladium (Pd) over 10 μ inches of Nickel (Ni). All models, (+) suffix.

For RoHS-5 Case Styles: Tin-Lead plate. All models, no (+) suffix.



Tape & Reel Packaging TR-F87

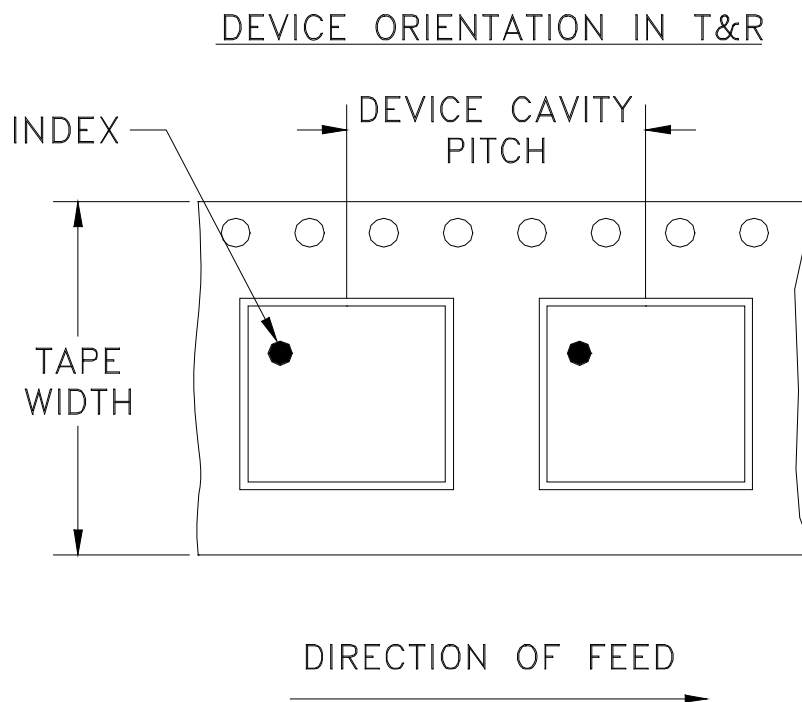

Tape Width, mm	Device Cavity Pitch, mm	Reel Size, inches	Devices per Reel	
12	8	7	Small quantity standards (see note)	20
				50
				100
				200
				500
		1000		
		13	Standard	3000

Note : Please Consult individual model data sheet to determine device per reel availability

Mini-Circuits carrier tape materials provide protection from ESD (Electro-Static Discharge) during handling and transportation. Tapes are static dissipative and comply with industry standards EIA-481/EIA-541.

Go to: www.minicircuits.com/pages/pdfs/tape.pdf



INTERNET <http://www.minicircuits.com>

P.O. Box 350166, Brooklyn, New York 11235-0003 (718) 934-4500 Fax (718) 332-4661

Distribution Centers NORTH AMERICA 800-654-7949 • 417-335-5935 • Fax 417-335-5945 • EUROPE 44-1252-832600 • Fax 44-1252-837010

Mini-Circuits ISO 9001 & ISO 14001 Certified

All Mini-Circuits products are manufactured under exacting quality assurance and control standards, and are capable of meeting published specifications after being subjected to any or all of the following physical and environmental test.

Specification	Test/Inspection Condition	Reference/Spec
Operating Temperature	-40° to 85° C or -40° to 105° C Ambient Environment	Refer to Individual Model Data Sheet
Storage Temperature	-55° to 100° C or -65° to 150° C Ambient Environment	Refer to Individual Model Data Sheet
Temperature Humidity Bias	85°C, 85% RH, 96 hours	JESD22-A101B
Thermal Shock	-55° to 100°C, 100 cycles	MIL-STD-202, Method 107, Condition A-3, except +100°C
Solder Reflow Heat	Pb-Free Process: 260°C peak	J-STD-020, Table 4-1, 4-2 and 5-2; Figure 5-1
Solderability	10X magnification, 95% coverage	JESD22-B102, Method 1: Dip and Look Test
Marking Resistance to Solvents	Laser marked, visual observation	Mini-Circuits D4-Q4T0-04