

Surface Mount Digital Step Attenuator

DAT-3175A Series

75Ω 0 to 31 dB, 1.0 dB Step 1MHz to 2.5 GHz

The Big Deal

- Wideband, operates up to 2.5 GHz
- Glitchless attenuation transitions
- High IP3, 52 dBm



CASE STYLE: DG983-2

Product Overview

The DAT-3175A+ series of 75Ω digital step attenuators provides adjustable attenuation from 0 to 31 dB in 1.0 dB steps. The control is a 5-bit serial/parallel interface, and the attenuators operate with either single positive or dual (positive and negative) supply voltage. DAT-3175A+ series models are produced by a unique CMOS process on silicon, offering the performance of GaAs with the advantages of conventional CMOS devices.

Key Features

Feature	Advantages
Wideband operation, specified from 1MHz to 2.5 GHz	Can be used in multiple applications such as various versions of DOCSIS, satellite and defense, reducing part count.
Serial or parallel interface	Models available with serial or parallel interface mode to suit customer demand.
Good VSWR, 1.3:1 typ.	Eases interfacing with adjacent components and results in low amplitude ripple.
Single positive supply models: (Model suffixes: -SP+ and -PP+) +2.3 to +3.6V+	Use of single positive supply simplifies power supply design. An internal negative voltage generator supplies the desired negative voltage. Single positive supply results in excellent spurious performance, -140 dBm typical.
Dual supply models: (Model suffixes: -SN+ and -PN+) +2.7 to +3.6V (Positive) and -3.6 to -3.2V (Negative)	Dual supply provides spurious-free operation. It also allows fast switching up to 1 MHz (vs. 25 kHz for single supply).
Useable over a wide range of supply voltages, +2.3/2.7 to 5.2V	Wide range of positive operating voltages allows the DAT-3175A+ Series of models to be used in a wide range of applications. See Application Note AN-70-032 for operation above +3.6V
Footprint compatible to DAT-3175-XX+ Series (XX=SN/SP/PN/PP)	Can fit into existing footprint and provide wideband performance, to 2.5 GHz instead of 2.0 GHz.
Glitchless Attenuation Transitions, 0.26 typical	Compared to previous generation of digital attenuators which is a vast improvement.



Digital Step Attenuator

75Ω 1-2500 MHz

31 dB, 1.0 dB Step
5 Bit, Serial Control Interface, Single Supply Voltage

Product Features

- Single positive supply voltage
- Immune to latch up
- Glitchless attenuation transitions
- Excellent accuracy, 0.1 dB Typ
- Low Insertion Loss
- High IP3, +55-59 dBm Typ
- Very low DC power consumption
- Excellent return loss, 18 dB Typ
- Small size 4.0 x 4.0 mm

Typical Applications

- DOCSIS® 3.1
- Portable Wireless
- CATV & DBS
- MMDS & Wireless LAN
- Wireless Local Loop
- UNII & Hiper LAN
- Power amplifier distortion canceling loops



Generic photo used for illustration purposes only

DAT-3175A-SP+

CASE STYLE: DG983-2

+RoHS Compliant

The +Suffix identifies RoHS Compliance. See our web site for RoHS Compliance methodologies and qualifications

General Description

The DAT-3175A-SP+ is a 75Ω RF digital step attenuator that offers an attenuation range up to 31 dB in 1.0 dB steps. The control is a 5-bit serial interface, operating on single (positive) supply voltage. The DAT-3175A-SP+ is produced using a unique CMOS process on silicon, offering the performance of GaAs, with the advantages of conventional CMOS devices.

Simplified Schematic

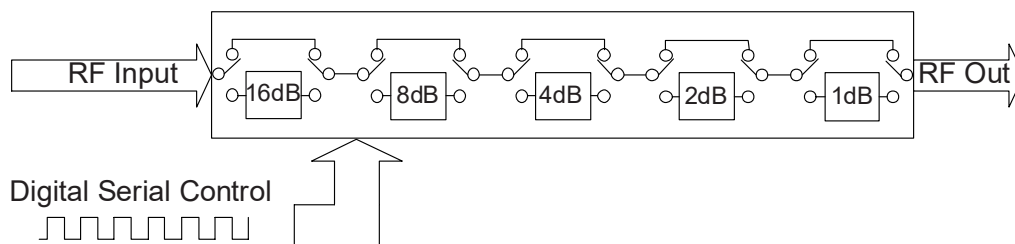

RF Electrical Specifications, 1-2500 MHz, $T_{AMB}=25^{\circ}C$, $V_{DD}=+3V$, 75Ω

Parameter	Freq. Range (GHz)	Min.	Typ.	Max.	Units
Accuracy @ 1 dB Attenuation Setting	0.001-1.2	—	0.03	0.18	dB
	1.2-2.0	—	0.1	0.20	
	2.0-2.5	—	0.1	0.23	
Accuracy @ 2 dB Attenuation Setting	0.001-1.2	—	0.07	0.21	dB
	1.2-2.0	—	0.15	0.26	
	2.0-2.5	—	0.15	0.31	
Accuracy @ 4 dB Attenuation Setting	0.001-1.2	—	0.05	0.27	dB
	1.2-2.0	—	0.15	0.36	
	2.0-2.5	—	0.2	0.47	
Accuracy @ 8 dB Attenuation Setting	0.001-1.2	—	0.1	0.39	dB
	1.2-2.0	—	0.24	0.60	
	2.0-2.5	—	0.35	0.79	
Accuracy @ 16 dB Attenuation Setting	0.001-1.2	—	0.23	0.63	dB
	1.2-2.5	—	0.8	1.0	
	2.0-2.5	—	0.8	1.43	
Insertion Loss ¹ @ all attenuator set to 0dB	0.001-1.2	—	1.2	1.8	dB
	1.2-2.5	—	1.6	1.9	
VSWR	0.001-1.2	—	1.3	—	:1
	1.2-2.5	—	1.4	—	
Input IP3 (at Min. and Max. Attenuation)	.005-2.5	—	55-69	—	dBm
Input IP2	.005-2.5	—	See Fig. 1	—	dBm
Input Power @ 0.1dB Compression (at Min. and Max. Attenuation)	0.030-2.5	—	+30	—	dBm
Input Operating Power	1 MHz to 30 MHz	—	—	See Fig. 2	dBm
	>30 MHz	—	—	+24	
Thermal Resistance (Junction to case)	—	—	25	—	$^{\circ}C/W$

DC Electrical Specifications

Parameter	Min.	Typ.	Max.	Units
V_{DD} Supply Voltage	2.3	3	3.6 ²	V
I_{DD} Supply Current	—	—	200	μA
Control Input Low	-0.3	—	0.6 ³	V
Control Input High	1.17	—	3.6	V
Control Current	—	—	20	μA

1. I. Loss values are de-embedded from test board Loss (test board's Insertion Loss: 0.10dB @ 100MHz, 0.40dB @ 1200MHz, 0.55dB @ 2000MHz, 0.75dB @ 4000MHz).
2. For operation above +3.6V see application note, AN-70-032
3. 0 Volt during power up.

Absolute Maximum Ratings⁴

Parameter	Ratings	
Operating Temperature	-40 $^{\circ}C$ to 105 $^{\circ}C$	
Storage Temperature	-65 $^{\circ}C$ to 150 $^{\circ}C$	
V_{DD}	-0.3V Min., 5.5V Max.	
Voltage on any input	-0.3V Min., 3.6V Max.	
Input Power	1-30 MHz	Figure 2
	30-2500 MHz	+30dBm

4. Permanent damage may occur if any of these limits are exceeded.
5. Operation between max operating and absolute max input power will result in reduced reliability.

Switching Specifications

Parameter	Min.	Typ.	Max.	Units
Switching Speed, 50% Control to 90% or 10% of RF	—	0.4	0.7	μSec
Switching Control Frequency	—	—	25	kHz

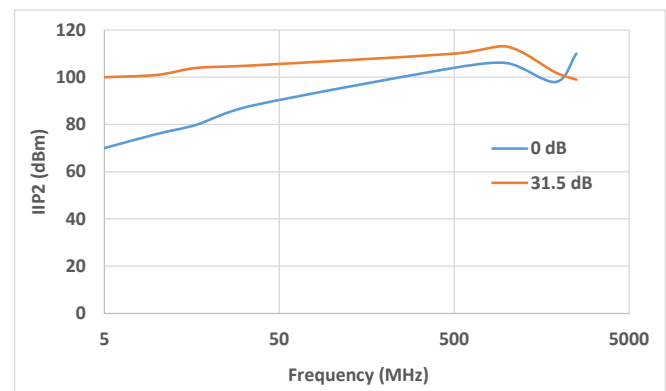

Fig 1. IP2 vs. Frequency and Attenuation

Pin Description

Function	Pin Number	Description
C16	1	Control for Attenuation bit, 16dB (Notes 4,7)
RF in	2	RF in port (Note 1)
Data	3	Serial Interface data input (Note 3)
Clock	4	Serial Interface clock input
LE	5	Latch Enable Input (Note 2)
V _{DD}	6	Power Supply
N/C	7	Not connected
N/C	8	Not connected
V _{DD}	9	Power Supply
GND	10	Ground connection
GND	11	Ground connection
GND	12	Ground connection (Note 7)
V _{DD}	13	Power Supply
RF out	14	RF out port (Note 1)
C8	15	Control for attenuation bit, 8 dB (Note 4)
C4	16	Control for attenuation bit, 4 dB (Note 4)
C2	17	Control for attenuation bit, 2 dB (Note 4)
GND	18	Ground Connection
C1	19	Control for attenuation bit, 1 dB (Note 4)
N/C	20	Not connected (Note 7,8)
GND	Paddle	Paddle ground (Note 6)

Notes:

- Both RF ports must be held at 0VDC or DC blocked with an external series capacitor.
- Latch Enable (LE) has an internal 2MΩ resistor to V_{DD}.
- Place a 10KΩ resistor in series, as close to pin as possible to avoid freq. resonance.
- Refer to Power-up Control Settings.
- The exposed solder pad on the bottom of the package (See Pin configuration) must be grounded for proper device operation.
- Ground must be less than 80 mil (0.08") from Pin 12 for proper device operation.
- This pin has internal 1MΩ pull down resistor to ground.
- Place 10KΩ resistor to ground externally.

Pin Configuration (Top View)

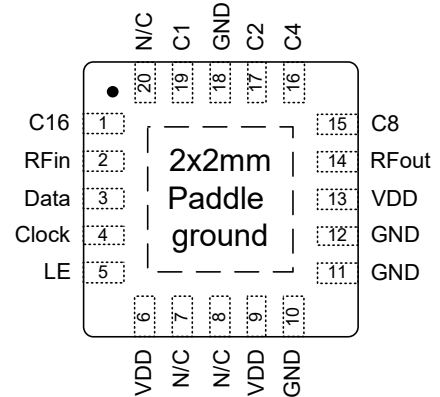

Device Marking

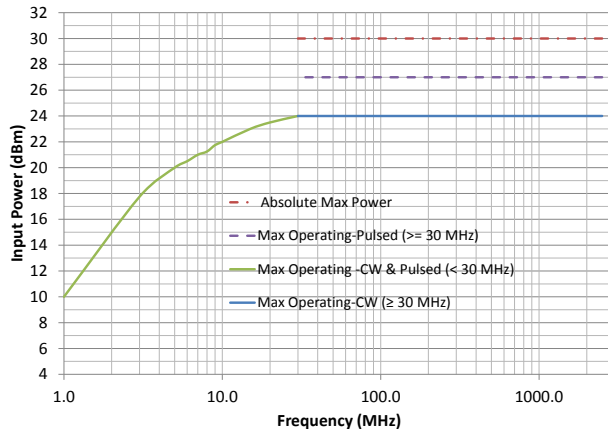
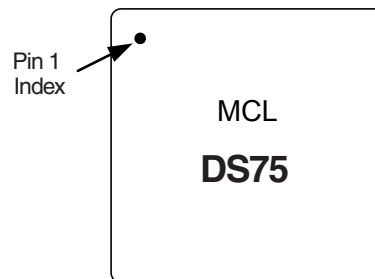

Pulsed Power: 5% duty cycle, 4620 μs period

Simplified Schematic

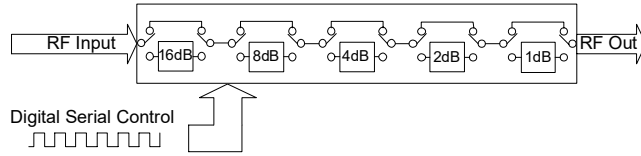

The DAT-3175A-SP+ serial interface consists of 5 control bits that select the desired attenuation state, as shown in Table 1: Truth Table

Attenuation State	C16	C8	C4	C2	C1
Reference	0	0	0	0	0
1 (dB)	0	0	0	0	1
2 (dB)	0	0	0	1	0
4 (dB)	0	0	1	0	0
8 (dB)	0	1	0	0	0
16 (dB)	1	0	0	0	0
31 (dB)	1	1	1	1	1

Note: Not all 32 possible combinations of C1 - C16 are shown in table

The serial interface is a 5-bit serial in, parallel-out shift register buffered by a transparent latch.

It is controlled by three CMOS-compatible signals: Data, Clock, and Latch Enable (LE). The Data and Clock inputs allow data to be serially entered into the shift register, a process that is independent of the state of the LE input.

The LE input controls the latch. When LE is HIGH, the latch is transparent and the contents of the serial shift register control the attenuator. When LE is brought LOW, data in the shift register is latched.

The shift register should be loaded while LE is held LOW to prevent the attenuator value from changing as data is entered. The LE input should then be toggled HIGH and brought LOW again, latching the new data. The timing for this operation is defined by **Figure 3** (Serial Interface Timing Diagram) and **Table 2** (Serial Interface AC Characteristics).

Figure 3: Serial Interface Timing Diagram

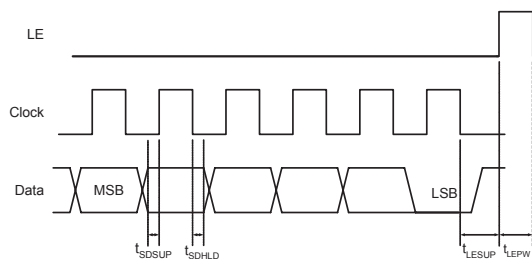

Symbol	Parameter	Min.	Max.	Units
f_{clk}	Serial data clock frequency (Note 1)		10	MHz
t_{clkH}	Serial clock HIGH time	30		ns
t_{clkL}	Serial clock LOW time	30		ns
t_{LESUP}	LE set-up time after last clock falling edge	10		ns
t_{LEPW}	LE minimum pulse width	30		ns
t_{SDSUP}	Serial data set-up time before clock rising edge	10		ns
t_{SDHLD}	Serial data hold time after clock falling edge	10		ns

Note 1. fclk verified during the functional pattern test. Serial programming sections of the functional pattern are clocked at 10MHz to verify fclk specification.

The DAT-3175A-SP+, uses a common 5-bit serial word format, as shown in Table 3: 5-Bit attenuator Serial Programming Register Map.

The first bit, the MSB, corresponds to the 16-dB Step and B1 bit corresponds to the 1dB step.

Table 3. 5-Bit attenuator Serial Programming Register Map					
B5	B4	B3	B2	B1	B0
C16	C8	C4	C2	C1	0

↑
MSB
(first in)

Note: The stop bit (B0) must always be low to prevent the attenuator from entering an unknown state.

↑
LSB
(last in)

Power-up Control Settings

The DAT-3175A-SP+ always assumes a specifiable attenuation setting on power-up, allowing a known attenuation state to be established before an initial serial control word is provided.

When the attenuator powers up, the five control bits are set to whatever data is present on the five data inputs (C1 to C16).

This allows any one of the 32 attenuation settings to be specified as the power-up state.

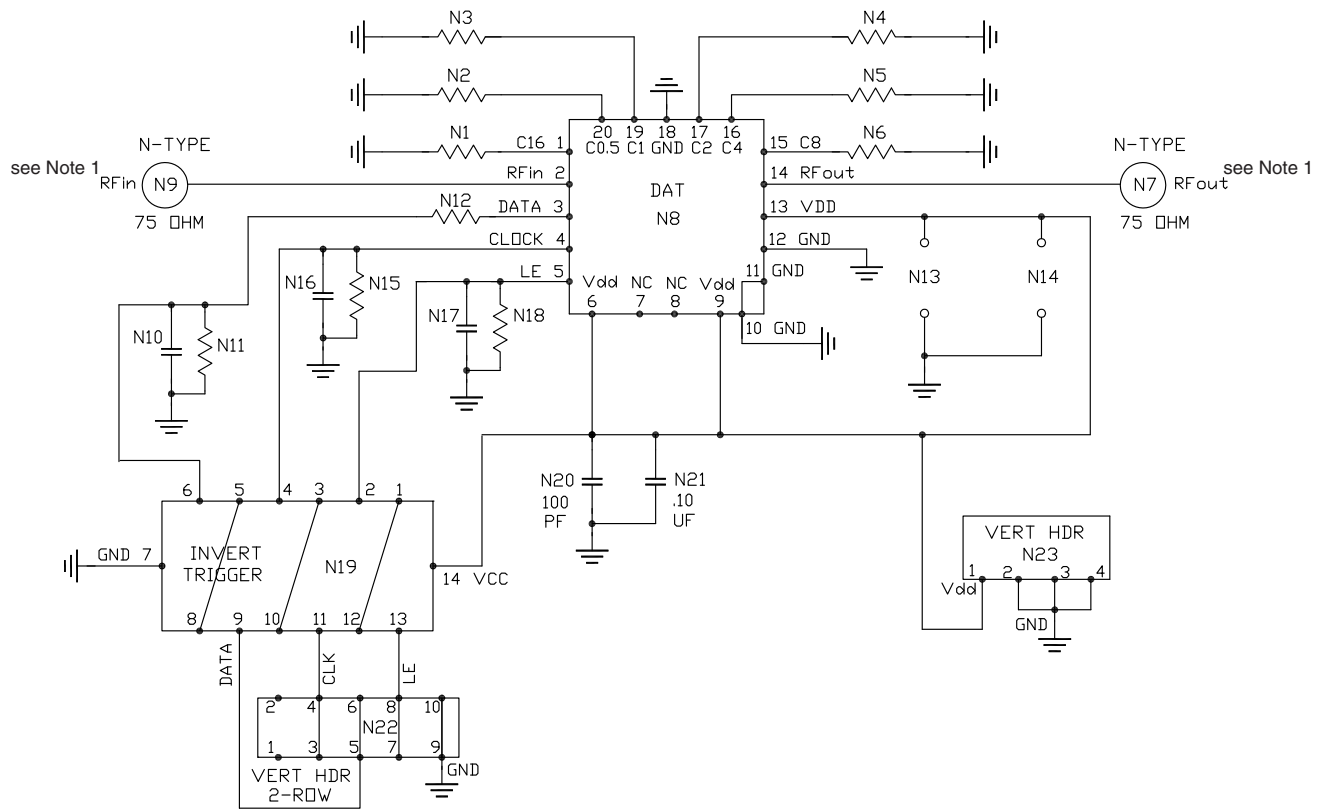

Note 1: Both RF ports must be held at 0VDC or DC blocked with an external series capacitor.

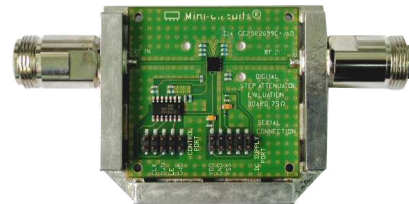

TB-344

Bill of Materials	
N1-N6, N11, N12, N15, N18	Resistor 0603 10 KOhm +/- 1%
N10, N16, N17, N20	NPO Capacitor 0603 100pF +/- 5%
N21	Tantalum Capacitor 0805 100nF +/- 10%
N19	Hex Invert Schmitt Trigger MSL1

** N12 can be reduced to 0Ω

Additional Detailed Technical Information	
<i>additional information is available on our dash board. To access this information click here</i>	
Performance Data	Data Table
	Swept Graphs
	S-Parameter (S2P Files) Data Set (.zip file)
Case Style	DG983-2 <i>Plastic package, exposed paddle, lead finish: NiPdAu</i>
Tape & Reel Standard quantities available on reel	F87 <i>7" reels with 20, 50, 100, 200, 500 Or 1000 devices 13" reels with 3K devices</i>
Suggested Layout for PCB Design	PL-203
Evaluation Board	TB-344
Environmental Ratings	ENV33T1

ESD Rating

Human Body Model (HBM): Class 1C (1000 to <2000V) in accordance with MIL-STD-883 method 3015 (pass 1500V)

Charge Device Model class C2 (500 to <1000V) per JESD22-C101

MSL Rating

Moisture Sensitivity: MSL1 in accordance with IPC/JEDEC J-STD-020D

MSL Test Flow Chart

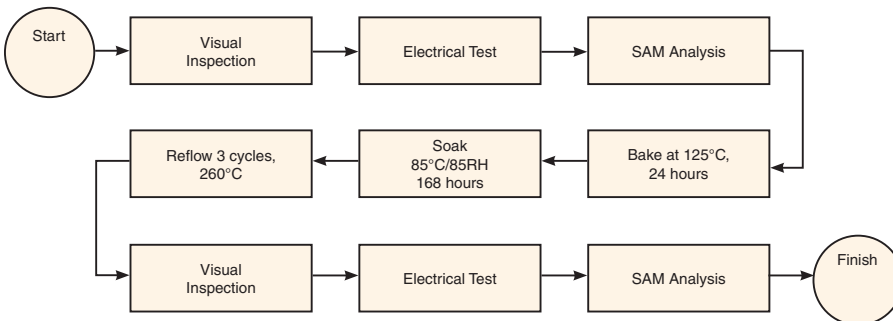

Additional Notes

- Performance and quality attributes and conditions not expressly stated in this specification document are intended to be excluded and do not form a part of this specification document.
- Electrical specifications and performance data contained in this specification document are based on Mini-Circuit's applicable established test performance criteria and measurement instructions.
- The parts covered by this specification document are subject to Mini-Circuits standard limited warranty and terms and conditions (collectively, "Standard Terms"); Purchasers of this part are entitled to the rights and benefits contained therein. For a full statement of the Standard Terms and the exclusive rights and remedies thereunder, please visit Mini-Circuits' website at www.minicircuits.com/MCLStore/terms.jsp

Digital Step Attenuator

DAT-3175A-SP+

Typical Performance Data

TEST CONDITIONS: INPUT POWER=-10dBm, Vdd=+3V, TEMPERATURE=-45degC

FREQUENCY (MHz)	STEP ATTENUATION* AT TTL CONTROL STATE (dB)						
	00000 THRU LOSS	00001 1.0 dB	00010 2.0 dB	00100 4.0 dB	01000 8.0 dB	10000 16 dB	11111 31 dB
10	0.93	1.06	2.07	4.14	8.22	16.32	31.59
50	0.94	1.05	2.06	4.13	8.20	16.28	31.45
100	0.94	1.05	2.05	4.13	8.20	16.28	31.41
150	0.96	1.05	2.05	4.12	8.20	16.28	31.43
200	0.96	1.05	2.05	4.12	8.20	16.27	31.43
250	0.96	1.05	2.06	4.13	8.20	16.28	31.43
300	0.96	1.05	2.06	4.13	8.21	16.29	31.46
350	0.97	1.05	2.06	4.13	8.21	16.30	31.44
400	0.98	1.05	2.06	4.13	8.21	16.29	31.43
450	0.99	1.04	2.05	4.12	8.20	16.28	31.43
500	1.00	1.04	2.05	4.12	8.19	16.27	31.48
550	1.02	1.04	2.05	4.11	8.18	16.26	31.45
600	1.04	1.04	2.04	4.10	8.17	16.25	31.48
700	1.07	1.03	2.03	4.09	8.15	16.23	31.41
800	1.12	1.03	2.03	4.08	8.14	16.21	31.25
900	1.13	1.03	2.03	4.08	8.14	16.22	31.43
1000	1.16	1.03	2.03	4.07	8.15	16.25	31.64
1100	1.19	1.02	2.02	4.07	8.14	16.24	31.56
1200	1.21	1.02	2.02	4.07	8.13	16.21	31.21
1300	1.20	1.02	2.02	4.06	8.12	16.15	30.74
1400	1.19	1.02	2.02	4.06	8.11	16.10	30.41
1500	1.22	1.02	2.02	4.08	8.15	16.21	31.21
1600	1.27	1.02	2.03	4.09	8.18	16.30	31.60
1700	1.27	1.02	2.02	4.10	8.18	16.28	31.20
1800	1.28	1.02	2.03	4.10	8.17	16.24	30.70
1900	1.29	1.03	2.03	4.11	8.17	16.17	30.11
2000	1.31	1.03	2.03	4.11	8.17	16.12	29.80
2100	1.32	1.03	2.03	4.12	8.19	16.12	29.62
2200	1.32	1.03	2.03	4.14	8.22	16.10	29.59
2300	1.39	1.03	2.04	4.15	8.27	16.22	30.19
2400	1.46	1.04	2.05	4.19	8.34	16.37	30.72
2500	1.25	1.04	2.05	4.18	8.30	16.12	29.30
2600	1.15	1.05	2.07	4.24	8.39	16.26	29.54
2700	1.13	1.06	2.09	4.30	8.46	16.35	29.68
2800	1.28	1.05	2.09	4.33	8.53	16.54	30.64
2900	1.59	1.03	2.05	4.31	8.51	16.63	31.22
3000	2.06	0.99	2.00	4.26	8.49	16.88	33.80

* Step Attenuation above Thru Loss (TTL Logic 00000).



REV. OR
DAT-3175A-SN+

10/14/2016

Page 1 of 9



Digital Step Attenuator

DAT-3175A-SP+

Typical Performance Data

TEST CONDITIONS: INPUT POWER=-10dBm, Vdd=+3V, TEMPERATURE=-45degC

FREQUENCY (MHz)	INPUT RETURN LOSS AT TTL CONTROL STATE (dB)						
	00000 0 dB	00001 1.0 dB	00010 2.0 dB	00100 4.0 dB	01000 8.0 dB	10000 16 dB	11111 31 dB
10	20.22	23.01	24.78	35.88	28.43	24.56	22.98
50	19.91	22.55	24.17	38.28	29.62	25.27	23.62
100	20.03	22.65	24.24	37.04	29.52	25.33	23.71
150	19.73	22.19	23.65	39.01	30.91	26.26	24.50
200	19.80	22.29	23.74	39.08	30.77	26.19	24.43
250	19.57	22.03	23.49	41.55	31.44	26.54	24.72
300	19.65	22.19	23.72	38.04	30.31	25.85	24.17
350	19.48	22.02	23.54	36.79	30.15	25.80	24.13
400	19.51	22.02	23.56	33.05	28.84	25.23	23.69
450	19.42	21.89	23.34	32.11	28.83	25.42	23.88
500	19.42	21.77	23.12	30.25	28.10	25.25	23.86
550	19.41	21.71	22.99	30.35	28.52	25.73	24.30
600	19.39	21.60	22.82	29.52	28.15	25.76	24.41
700	19.48	21.60	22.72	29.19	28.11	26.02	24.72
800	19.32	21.35	22.34	28.16	27.46	25.88	24.75
900	19.05	20.96	21.87	27.08	26.60	25.51	24.57
1000	18.61	20.44	21.30	26.43	26.18	25.42	24.62
1100	18.07	19.83	20.63	25.88	26.07	25.86	25.24
1200	17.68	19.33	20.07	25.54	26.11	26.59	26.34
1300	17.29	18.87	19.55	25.55	26.67	28.11	28.37
1400	16.80	18.32	18.97	25.26	26.94	29.57	30.91
1500	16.60	18.09	18.76	25.55	27.96	32.27	35.41
1600	16.77	18.26	18.92	26.46	29.93	38.38	53.53
1700	17.69	19.15	19.73	27.85	31.49	33.39	31.15
1800	19.01	20.29	20.74	26.87	28.13	26.68	25.10
1900	20.02	20.88	21.22	23.93	24.33	22.90	21.70
2000	20.36	20.73	21.05	21.32	21.48	20.29	19.32
2100	20.47	20.33	20.59	19.25	19.18	18.18	17.37
2200	20.06	19.70	19.91	17.93	17.75	16.87	16.16
2300	21.78	21.21	21.36	18.25	17.69	16.65	15.92
2400	26.45	24.09	23.31	17.95	16.81	15.69	15.03
2500	32.58	25.50	23.20	16.99	15.48	14.44	13.93
2600	24.79	22.55	20.68	15.68	14.04	13.14	12.73
2700	19.06	19.06	18.19	14.67	13.09	12.29	11.95
2800	14.86	15.63	15.58	13.70	12.44	11.81	11.55
2900	12.26	13.26	13.60	12.88	12.06	11.63	11.43
3000	10.49	11.59	12.14	12.32	11.97	11.82	11.72

Digital Step Attenuator

DAT-3175A-SP+

Typical Performance Data

TEST CONDITIONS: INPUT POWER=-10dBm, Vdd=+3V, TEMPERATURE=-45degC

FREQUENCY (MHz)	OUTPUT RETURN LOSS AT TTL CONTROL STATE (dB)						
	0000 0 dB	00001 1.0 dB	00010 2.0 dB	00100 4.0 dB	01000 8.0 dB	10000 16 dB	11111 31 dB
10	20.09	22.48	24.72	28.83	28.94	24.58	23.03
50	19.76	22.07	24.00	27.63	30.16	25.30	23.64
100	19.67	21.91	23.78	27.21	30.39	25.57	23.91
150	19.27	21.40	23.13	26.26	32.30	26.65	24.82
200	19.43	21.59	23.40	26.62	31.85	26.41	24.58
250	19.40	21.57	23.37	26.70	32.07	26.41	24.59
300	19.56	21.81	23.73	27.19	30.41	25.61	23.92
350	19.36	21.58	23.45	26.79	30.28	25.59	23.96
400	19.13	21.33	23.16	26.14	29.01	25.15	23.64
450	18.78	20.87	22.62	25.37	29.52	25.68	24.12
500	18.45	20.44	22.05	24.47	29.13	25.90	24.39
550	18.38	20.31	21.86	24.22	30.02	26.70	25.04
600	18.30	20.15	21.67	23.80	29.98	27.04	25.41
700	18.42	20.22	21.67	23.65	30.44	27.79	26.05
800	18.60	20.33	21.74	23.46	30.24	28.13	26.46
900	19.26	21.06	22.50	24.00	29.11	27.08	25.56
1000	19.58	21.30	22.62	23.80	28.38	26.79	25.44
1100	19.17	20.69	21.83	22.60	27.19	26.68	25.72
1200	18.89	20.26	21.26	21.76	26.34	26.58	26.04
1300	19.08	20.41	21.35	21.61	25.95	26.28	25.88
1400	19.26	20.54	21.45	21.56	25.90	26.29	26.07
1500	19.04	20.26	21.11	21.28	26.94	28.00	28.02
1600	18.11	19.19	19.95	20.14	26.12	28.18	29.33
1700	17.92	19.01	19.80	20.15	27.25	30.45	32.62
1800	17.84	18.98	19.84	20.66	30.51	38.92	50.02
1900	17.90	19.09	20.04	21.67	32.79	34.34	30.91
2000	17.92	19.07	20.01	22.57	27.39	25.84	24.20
2100	17.73	18.94	19.92	23.03	24.78	23.15	21.70
2200	18.95	20.20	21.13	25.19	22.41	20.49	19.34
2300	20.55	21.59	22.04	25.54	19.72	18.09	17.14
2400	23.22	24.15	24.19	26.88	19.02	17.34	16.45
2500	33.21	33.28	28.77	25.00	17.63	16.13	15.38
2600	31.80	31.55	26.88	21.17	16.12	14.79	14.19
2700	21.25	22.41	21.92	17.98	14.79	13.64	13.15
2800	15.48	16.77	17.43	15.52	14.06	13.17	12.80
2900	11.84	13.01	13.83	13.12	13.01	12.55	12.32
3000	9.65	10.72	11.57	11.47	12.26	12.27	12.20

Digital Step Attenuator

DAT-3175A-SP+

Typical Performance Data

TEST CONDITIONS: INPUT POWER=-10dBm, Vdd=+3V, TEMPERATURE=25degC

FREQUENCY (MHz)	STEP ATTENUATION* AT TTL CONTROL STATE (dB)						
	00000 THRU LOSS	00001 1.0 dB	00010 2.0 dB	00100 4.0 dB	01000 8.0 dB	10000 16 dB	11111 31 dB
10	1.07	1.01	2.02	4.03	8.03	16.05	30.87
50	1.07	1.02	2.03	4.03	8.05	16.05	31.04
100	1.08	1.02	2.03	4.03	8.04	16.05	31.02
150	1.09	1.02	2.02	4.03	8.04	16.03	31.03
200	1.10	1.02	2.03	4.03	8.05	16.05	31.05
250	1.11	1.02	2.02	4.03	8.04	16.05	31.08
300	1.12	1.02	2.02	4.03	8.04	16.04	31.10
350	1.14	1.01	2.02	4.03	8.03	16.04	31.01
400	1.16	1.01	2.02	4.03	8.03	16.03	31.15
450	1.17	1.01	2.02	4.02	8.02	16.03	31.09
500	1.18	1.01	2.01	4.02	8.02	16.02	31.03
550	1.20	1.01	2.01	4.02	8.01	16.02	31.09
600	1.22	1.01	2.01	4.01	8.02	16.02	31.09
700	1.26	1.01	2.01	4.00	8.00	16.00	30.97
800	1.31	1.00	2.01	4.00	7.99	16.00	31.06
900	1.33	1.01	2.00	4.00	8.00	16.01	31.12
1000	1.37	1.00	2.00	4.00	8.01	16.04	31.34
1100	1.40	1.00	2.00	4.00	8.00	16.04	31.26
1200	1.42	1.00	2.00	3.99	8.00	16.01	30.90
1300	1.43	1.00	2.00	3.99	7.98	15.96	30.44
1400	1.44	1.00	1.99	3.99	7.98	15.92	30.26
1500	1.49	1.00	2.00	4.01	8.02	16.04	31.08
1600	1.52	1.00	2.00	4.02	8.05	16.10	31.22
1700	1.53	1.01	2.00	4.03	8.05	16.08	30.84
1800	1.55	1.00	2.00	4.03	8.05	16.04	30.48
1900	1.57	1.00	2.00	4.03	8.05	15.99	30.00
2000	1.60	1.00	2.00	4.03	8.05	15.94	29.72
2100	1.60	1.00	1.99	4.04	8.06	15.95	29.51
2200	1.58	1.01	2.00	4.05	8.08	15.94	29.46
2300	1.57	1.01	2.01	4.07	8.14	16.09	30.26
2400	1.50	1.01	2.01	4.11	8.19	16.14	30.09
2500	1.28	1.01	2.01	4.11	8.18	15.95	29.01
2600	1.22	1.02	2.02	4.16	8.24	16.04	29.30
2700	1.28	1.01	2.02	4.18	8.28	16.13	29.57
2800	1.47	1.00	2.01	4.18	8.31	16.22	30.19
2900	1.81	0.98	1.98	4.16	8.29	16.34	30.99
3000	2.27	0.95	1.93	4.11	8.27	16.55	33.45

* Step Attenuation above Thru Loss (TTL Logic 00000).



REV. OR
DAT-3175A-SN+

10/14/2016

Page 4 of 9

P.O. Box 350166, Brooklyn, New York 11235-0003 (718) 934-4500 • Fax (718) 332-4661 For detailed performance specs & shopping online see Mini-Circuits web site
The Design Engineers Search Engine Provides ACTUAL Data Instantly From MINI-CIRCUITS At: www.minicircuits.com



IF/RF MICROWAVE COMPONENTS

Digital Step Attenuator

DAT-3175A-SP+

Typical Performance Data

TEST CONDITIONS: INPUT POWER=-10dBm, Vdd=+3V, TEMPERATURE=25degC

FREQUENCY (MHz)	INPUT RETURN LOSS AT TTL CONTROL STATE (dB)						
	00000 0 dB	00001 1.0 dB	00010 2.0 dB	00100 4.0 dB	01000 8.0 dB	10000 16 dB	11111 31 dB
10	19.07	20.64	21.24	32.45	38.64	43.95	35.76
50	18.84	20.36	21.00	31.28	36.43	52.51	37.96
100	18.98	20.49	21.20	31.85	37.50	45.91	36.46
150	18.71	20.21	20.89	30.64	35.37	46.65	38.26
200	18.80	20.30	20.98	30.70	35.18	42.30	36.97
250	18.62	20.09	20.73	29.80	33.71	42.00	38.88
300	18.66	20.14	20.80	29.57	33.06	39.04	37.36
350	18.53	19.95	20.56	28.93	32.17	38.89	39.09
400	18.56	19.98	20.58	28.67	31.59	37.12	37.44
450	18.54	19.93	20.52	28.52	31.40	37.64	39.60
500	18.59	19.97	20.53	28.33	30.85	36.26	37.99
550	18.65	20.01	20.54	28.35	30.87	36.92	40.12
600	18.69	20.04	20.54	28.07	30.35	35.58	38.55
700	18.75	20.06	20.51	27.81	29.72	34.54	37.89
800	18.57	19.84	20.26	27.07	28.61	32.65	35.72
900	18.34	19.58	19.99	26.26	27.56	30.93	33.45
1000	17.98	19.20	19.61	25.51	26.66	29.84	32.39
1100	17.49	18.66	19.05	24.60	25.71	28.79	31.63
1200	17.00	18.12	18.48	23.72	24.75	27.68	30.59
1300	16.58	17.63	17.94	22.93	23.86	26.52	29.21
1400	16.28	17.24	17.49	22.22	22.98	25.25	27.47
1500	16.25	17.17	17.37	22.11	22.83	24.86	26.81
1600	16.54	17.40	17.51	22.25	22.91	24.49	25.83
1700	17.15	17.88	17.91	22.34	22.85	23.63	24.11
1800	17.79	18.30	18.26	21.86	22.30	22.30	22.18
1900	18.19	18.46	18.41	20.83	21.34	20.94	20.50
2000	18.28	18.39	18.43	19.72	20.34	19.74	19.12
2100	18.33	18.30	18.43	18.65	19.30	18.58	17.89
2200	18.19	18.10	18.36	17.99	18.60	17.88	17.18
2300	19.84	19.75	20.12	18.90	19.32	18.35	17.47
2400	24.19	23.62	23.95	19.97	19.60	18.26	17.32
2500	38.83	30.24	28.05	19.51	18.22	16.98	16.27
2600	26.49	25.70	23.72	17.87	16.28	15.34	14.86
2700	19.39	20.15	19.53	16.49	14.96	14.22	13.89
2800	15.13	16.19	16.24	15.16	14.02	13.55	13.35
2900	12.50	13.64	14.01	14.14	13.48	13.32	13.22
3000	10.71	11.84	12.39	13.38	13.26	13.48	13.53

Digital Step Attenuator

DAT-3175A-SP+

Typical Performance Data

TEST CONDITIONS: INPUT POWER=-10dBm, Vdd=+3V, TEMPERATURE=25degC

FREQUENCY (MHz)	OUTPUT RETURN LOSS AT TTL CONTROL STATE (dB)						
	0000 0 dB	00001 1.0 dB	00010 2.0 dB	00100 4.0 dB	01000 8.0 dB	10000 16 dB	11111 31 dB
10	18.99	20.28	21.25	22.34	37.78	43.52	35.35
50	18.73	19.99	20.95	22.01	35.53	51.06	37.46
100	18.78	20.05	21.02	22.14	36.04	45.23	36.46
150	18.46	19.68	20.63	21.73	34.02	45.54	38.56
200	18.39	19.65	20.61	21.70	33.50	41.44	37.29
250	18.12	19.33	20.26	21.32	32.22	41.61	40.09
300	18.06	19.27	20.19	21.22	31.48	38.70	38.66
350	17.86	19.03	19.92	20.88	30.70	38.35	41.38
400	17.84	19.02	19.90	20.85	30.27	37.10	39.59
450	17.81	18.93	19.81	20.70	30.05	37.67	43.50
500	17.75	18.89	19.75	20.60	29.67	36.56	42.09
550	17.81	18.91	19.76	20.56	29.63	37.03	46.69
600	17.80	18.90	19.74	20.48	29.26	36.16	44.82
700	18.03	19.09	19.90	20.53	29.37	36.42	48.00
800	18.35	19.40	20.19	20.68	29.46	36.38	47.52
900	18.97	20.04	20.84	21.20	30.47	38.11	44.90
1000	19.08	20.11	20.85	21.01	29.54	35.76	41.39
1100	18.74	19.65	20.34	20.28	27.45	31.82	35.72
1200	18.29	19.13	19.72	19.52	25.58	28.85	31.83
1300	18.02	18.75	19.30	18.96	24.48	27.29	29.93
1400	17.89	18.55	19.02	18.60	23.99	26.63	29.28
1500	17.54	18.09	18.48	18.11	23.36	25.73	28.19
1600	17.00	17.51	17.84	17.54	22.47	24.57	26.63
1700	17.04	17.55	17.90	17.72	22.87	24.93	26.80
1800	17.19	17.72	18.05	18.12	23.35	25.00	26.05
1900	17.49	17.98	18.36	18.87	23.71	24.45	24.47
2000	17.60	18.03	18.40	19.51	22.82	22.66	22.07
2100	17.90	18.42	18.86	20.50	22.73	22.03	21.15
2200	19.03	19.46	19.89	22.64	22.17	20.87	19.79
2300	19.60	20.04	20.41	23.92	20.88	19.57	18.51
2400	21.10	21.84	22.32	27.63	21.46	19.64	18.47
2500	25.61	27.74	28.54	35.77	20.78	18.79	17.71
2600	26.65	33.58	43.70	25.95	19.45	17.63	16.76
2700	20.38	22.58	24.07	19.99	17.65	16.35	15.72
2800	15.19	16.59	17.73	16.11	16.09	15.38	14.98
2900	11.94	13.09	14.07	13.39	14.49	14.41	14.26
3000	9.88	10.90	11.79	11.59	13.32	13.78	13.90

Digital Step Attenuator

DAT-3175A-SP+

Typical Performance Data

TEST CONDITIONS: INPUT POWER=-10dBm, Vdd=+3V, TEMPERATURE=85degC

FREQUENCY (MHz)	STEP ATTENUATION* AT TTL CONTROL STATE (dB)						
	00000 THRU LOSS	00001 1.0 dB	00010 2.0 dB	00100 4.0 dB	01000 8.0 dB	10000 16 dB	11111 31 dB
10	1.25	1.00	1.99	3.94	7.87	15.81	30.52
50	1.25	0.99	2.00	3.94	7.88	15.81	30.60
100	1.25	0.99	2.00	3.94	7.88	15.81	30.61
150	1.26	1.00	2.00	3.94	7.88	15.81	30.64
200	1.27	0.99	2.00	3.94	7.88	15.82	30.61
250	1.29	0.99	2.00	3.95	7.88	15.81	30.63
300	1.32	0.99	2.00	3.94	7.87	15.80	30.63
350	1.35	0.99	1.99	3.93	7.87	15.80	30.63
400	1.38	0.99	1.99	3.93	7.87	15.79	30.65
450	1.40	0.99	1.99	3.93	7.86	15.79	30.63
500	1.41	0.98	1.99	3.93	7.86	15.79	30.66
550	1.43	0.98	1.99	3.93	7.86	15.78	30.71
600	1.45	0.98	1.99	3.93	7.86	15.78	30.67
700	1.48	0.99	1.99	3.93	7.86	15.78	30.60
800	1.52	0.98	1.99	3.93	7.87	15.79	30.64
900	1.55	0.98	1.99	3.93	7.87	15.81	30.80
1000	1.60	0.98	1.99	3.93	7.88	15.84	30.96
1100	1.65	0.98	1.98	3.92	7.88	15.84	30.80
1200	1.70	0.98	1.98	3.92	7.86	15.80	30.48
1300	1.73	0.98	1.98	3.92	7.85	15.73	30.10
1400	1.75	0.98	1.98	3.92	7.86	15.74	30.15
1500	1.81	0.98	1.99	3.94	7.90	15.86	30.83
1600	1.83	0.98	1.99	3.96	7.92	15.91	30.84
1700	1.83	0.98	1.99	3.96	7.93	15.88	30.38
1800	1.83	0.98	1.99	3.97	7.94	15.84	30.05
1900	1.82	0.98	1.99	3.96	7.94	15.82	29.86
2000	1.81	0.98	1.99	3.97	7.95	15.82	29.67
2100	1.75	0.98	1.98	3.98	7.97	15.80	29.49
2200	1.70	0.98	1.98	3.99	7.99	15.81	29.39
2300	1.68	0.98	1.98	4.01	8.05	15.95	30.13
2400	1.53	0.97	1.97	4.01	8.04	15.85	29.11
2500	1.40	0.97	1.97	4.01	8.02	15.74	28.69
2600	1.40	0.97	1.97	4.03	8.06	15.80	29.04
2700	1.48	0.96	1.96	4.04	8.08	15.86	29.25
2800	1.68	0.95	1.95	4.05	8.10	15.95	29.94
2900	2.02	0.93	1.93	4.03	8.09	16.08	30.73
3000	2.45	0.91	1.89	4.01	8.09	16.29	33.09

* Step Attenuation above Thru Loss (TTL Logic 00000).



REV. OR
DAT-3175A-SN+

10/14/2016
Page 7 of 9

Digital Step Attenuator

DAT-3175A-SP+

Typical Performance Data

TEST CONDITIONS: INPUT POWER=-10dBm, Vdd=+3V, TEMPERATURE=85degC

FREQUENCY (MHz)	INPUT RETURN LOSS AT TTL CONTROL STATE (dB)						
	00000 0 dB	00001 1.0 dB	00010 2.0 dB	00100 4.0 dB	01000 8.0 dB	10000 16 dB	11111 31 dB
10	17.84	18.44	18.51	23.10	23.26	24.84	26.53
50	17.55	18.16	18.21	22.79	22.91	24.47	26.01
100	17.67	18.32	18.42	23.18	23.42	25.14	26.80
150	17.45	18.12	18.24	22.89	23.21	24.90	26.55
200	17.50	18.19	18.32	22.99	23.35	25.12	26.79
250	17.29	17.95	18.07	22.50	22.80	24.39	25.91
300	17.28	17.94	18.01	22.29	22.50	24.02	25.48
350	17.15	17.73	17.79	21.83	21.92	23.25	24.60
400	17.19	17.74	17.75	21.71	21.73	22.95	24.24
450	17.23	17.72	17.70	21.55	21.48	22.56	23.73
500	17.36	17.84	17.78	21.64	21.47	22.52	23.66
550	17.50	17.95	17.86	21.70	21.48	22.46	23.54
600	17.67	18.13	18.02	21.94	21.68	22.67	23.75
700	18.09	18.55	18.43	22.58	22.32	23.34	24.49
800	18.27	18.81	18.72	23.19	22.97	24.20	25.55
900	18.17	18.80	18.76	23.41	23.25	24.76	26.41
1000	17.62	18.30	18.32	22.77	22.74	24.33	26.07
1100	16.77	17.46	17.50	21.54	21.57	23.09	24.65
1200	15.92	16.57	16.62	20.25	20.28	21.57	22.90
1300	15.26	15.85	15.85	19.12	19.06	20.08	21.15
1400	14.93	15.42	15.35	18.32	18.15	18.91	19.76
1500	14.98	15.35	15.19	17.98	17.66	18.20	18.88
1600	15.38	15.59	15.33	17.86	17.45	17.71	18.18
1700	15.97	15.97	15.63	17.79	17.34	17.32	17.55
1800	16.47	16.28	15.91	17.61	17.28	17.05	17.05
1900	16.73	16.44	16.16	17.36	17.30	16.93	16.73
2000	16.96	16.65	16.51	17.26	17.52	17.04	16.65
2100	17.32	17.01	17.06	17.30	17.87	17.28	16.70
2200	17.88	17.65	17.83	17.83	18.67	17.96	17.21
2300	20.07	19.92	20.23	19.90	20.98	19.83	18.69
2400	24.66	24.81	25.51	23.29	24.17	22.06	20.36
2500	30.58	36.71	42.01	24.58	23.56	21.64	20.13
2600	25.02	28.35	28.21	22.82	20.95	19.86	18.93
2700	19.54	21.40	21.65	20.68	18.97	18.41	17.91
2800	15.94	17.42	17.88	18.60	17.50	17.42	17.23
2900	13.45	14.78	15.35	16.97	16.47	16.84	16.92
3000	11.58	12.80	13.42	15.57	15.67	16.56	16.95

Digital Step Attenuator

DAT-3175A-SP+

Typical Performance Data

TEST CONDITIONS: INPUT POWER=-10dBm, Vdd=+3V, TEMPERATURE=85degC

FREQUENCY (MHz)	OUTPUT RETURN LOSS AT TTL CONTROL STATE (dB)						
	0000 0 dB	00001 1.0 dB	00010 2.0 dB	00100 4.0 dB	01000 8.0 dB	10000 16 dB	11111 31 dB
10	17.76	18.13	18.44	18.17	23.04	24.97	26.45
50	17.57	17.98	18.25	18.10	22.86	24.62	26.23
100	17.74	18.18	18.50	18.39	23.38	25.38	27.13
150	17.55	18.03	18.36	18.29	23.27	25.25	26.98
200	17.45	17.96	18.32	18.26	23.23	25.24	27.01
250	17.05	17.54	17.88	17.84	22.47	24.28	25.84
300	16.82	17.26	17.60	17.55	21.94	23.64	25.07
350	16.55	16.96	17.26	17.16	21.27	22.76	24.05
400	16.53	16.93	17.20	17.06	21.06	22.48	23.72
450	16.54	16.90	17.15	16.95	20.81	22.12	23.26
500	16.66	17.01	17.22	17.01	20.84	22.11	23.22
550	16.85	17.16	17.35	17.11	20.91	22.07	23.14
600	17.03	17.33	17.51	17.24	21.08	22.24	23.29
700	17.41	17.71	17.89	17.57	21.56	22.70	23.75
800	17.76	18.09	18.29	17.92	22.24	23.51	24.62
900	18.23	18.61	18.85	18.40	23.16	24.59	25.89
1000	18.17	18.57	18.83	18.29	23.16	24.74	26.26
1100	17.68	18.09	18.37	17.75	22.40	24.05	25.66
1200	17.10	17.49	17.73	17.05	21.28	22.84	24.37
1300	16.69	17.00	17.20	16.43	20.27	21.61	22.94
1400	16.50	16.69	16.78	15.94	19.43	20.44	21.54
1500	16.14	16.17	16.15	15.34	18.36	19.08	19.93
1600	16.01	15.96	15.88	15.08	17.90	18.47	19.19
1700	16.25	16.11	15.99	15.28	17.95	18.33	18.86
1800	16.49	16.32	16.19	15.68	18.14	18.32	18.62
1900	16.70	16.53	16.44	16.28	18.37	18.32	18.35
2000	16.50	16.41	16.40	16.71	18.34	18.11	17.92
2100	16.84	16.84	16.93	17.82	19.04	18.60	18.17
2200	17.39	17.50	17.63	19.28	19.63	18.89	18.20
2300	17.94	18.15	18.35	20.72	20.19	19.19	18.29
2400	19.94	20.36	20.75	24.14	22.78	21.00	19.65
2500	22.98	24.15	25.18	30.95	24.97	21.99	20.26
2600	23.58	26.35	29.95	26.75	25.08	22.11	20.41
2700	19.59	21.52	23.59	20.49	22.04	20.68	19.63
2800	15.48	16.81	18.12	16.51	19.02	18.94	18.53
2900	12.54	13.62	14.66	13.79	16.56	17.25	17.35
3000	10.49	11.42	12.34	11.88	14.79	15.96	16.44

Digital Step Attenuator

Typical Performance Curves

DAT-3175A-SP+

Thru Loss

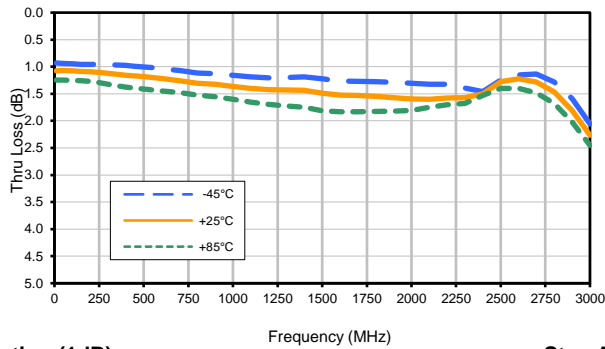

Step Attenuation (1dB)

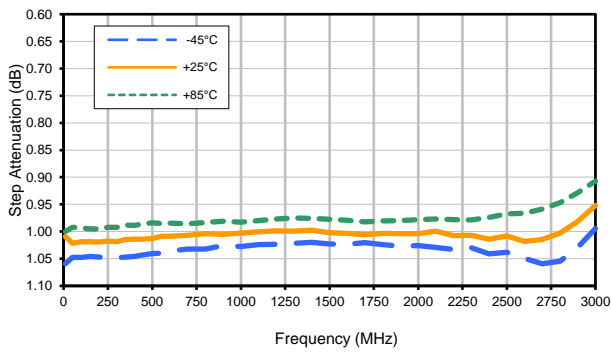

Step Attenuation (2dB)

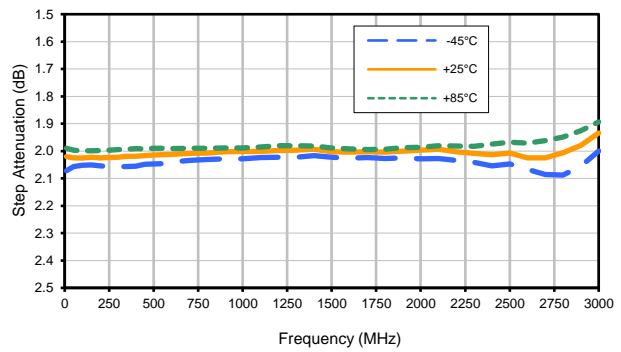

Step Attenuation (4dB)

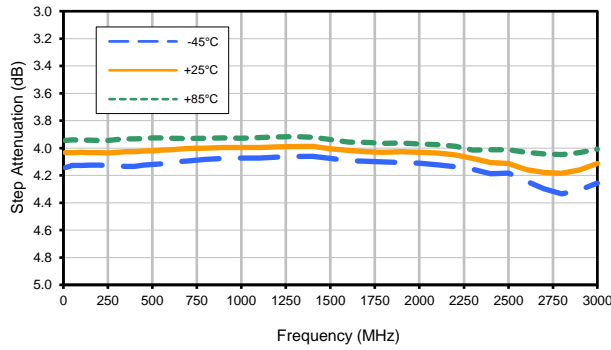

Step Attenuation (8dB)

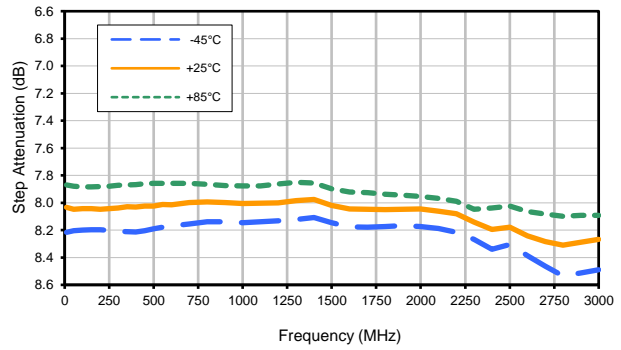

Step Attenuation (16dB)

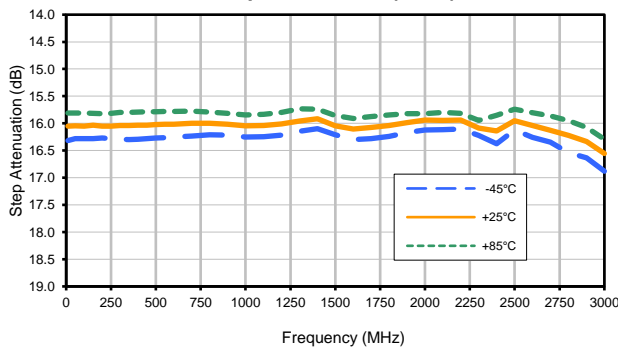

Step Attenuation (31dB)

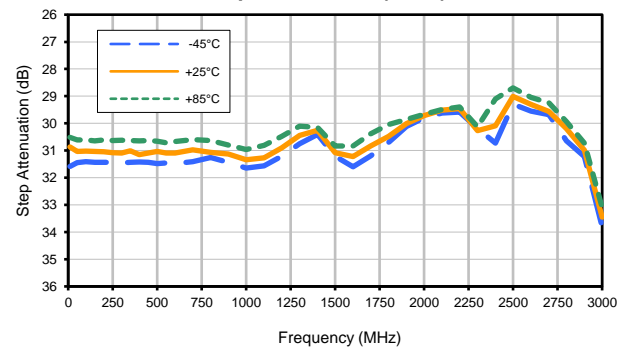

Digital Step Attenuator

Typical Performance Curves

DAT-3175A-SP+

Input Return Loss (0dB)

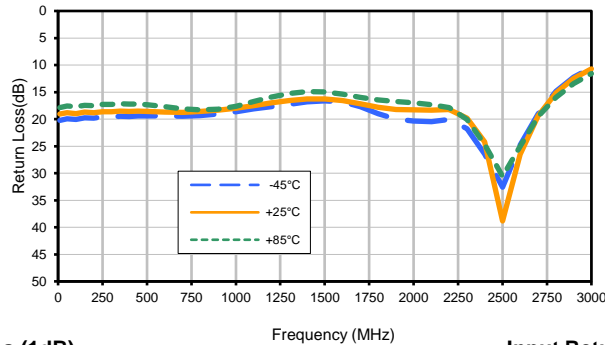

Input Return Loss (1dB)

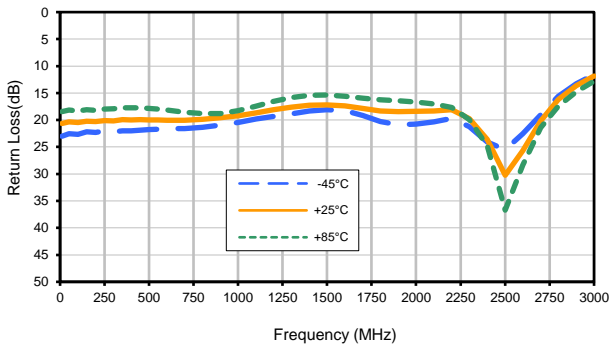

Input Return Loss (2dB)

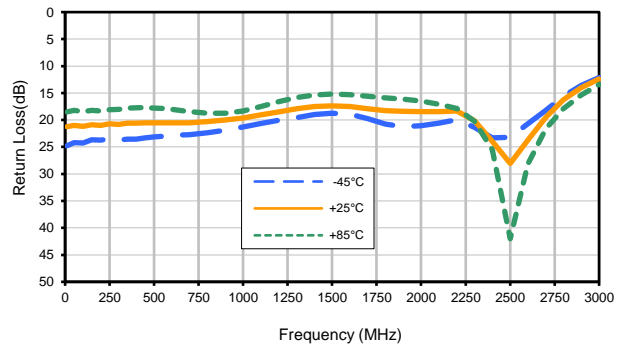

Input Return Loss (4dB)

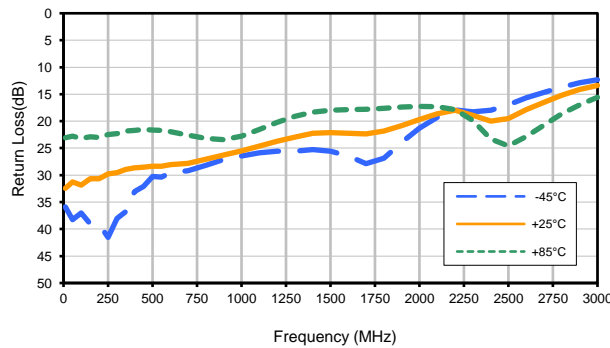

Input Return Loss (8dB)

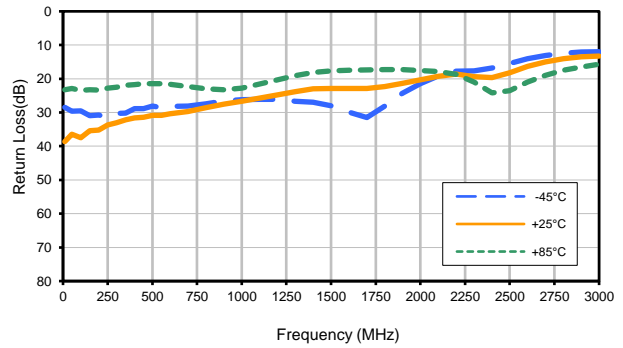

Input Return Loss (16dB)

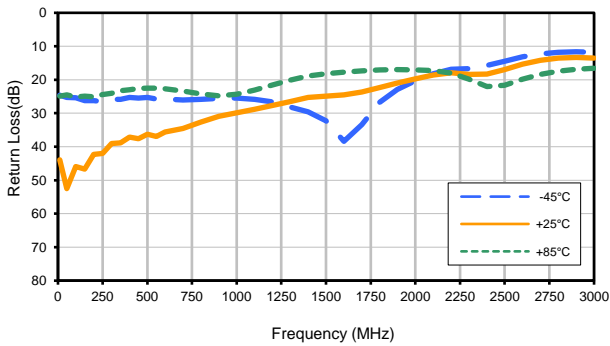

Input Return Loss (31dB)

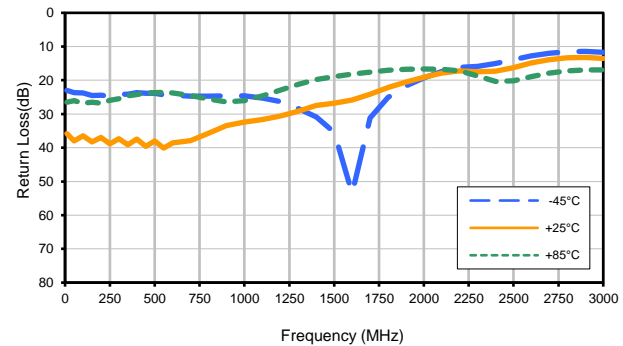

Digital Step Attenuator

Typical Performance Curves

DAT-3175A-SP+

Output Return Loss (0dB)

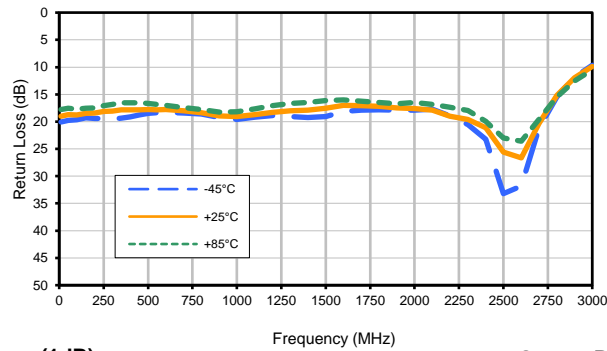

Output Return Loss (1dB)

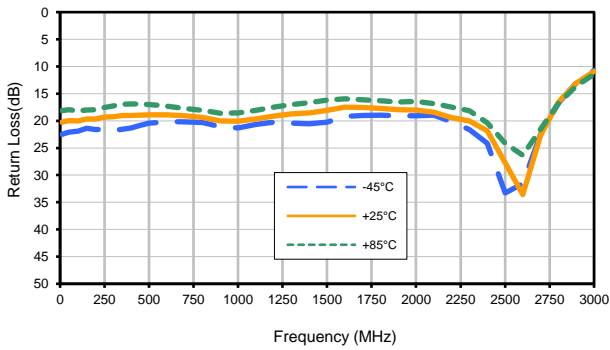

Output Return Loss (2dB)

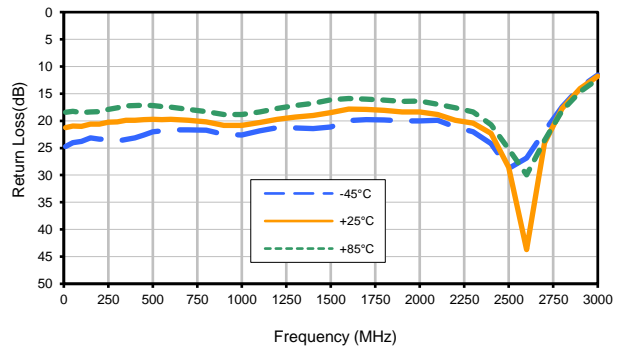

Output Return Loss (4dB)

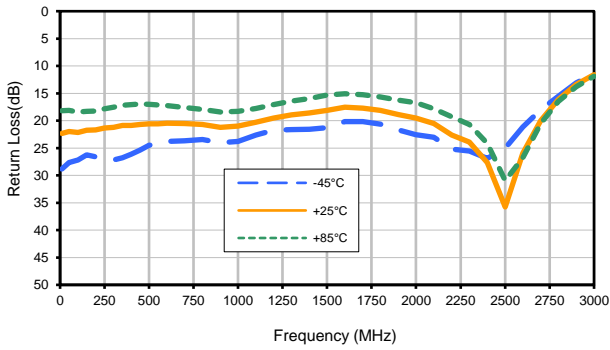

Output Return Loss(8dB)

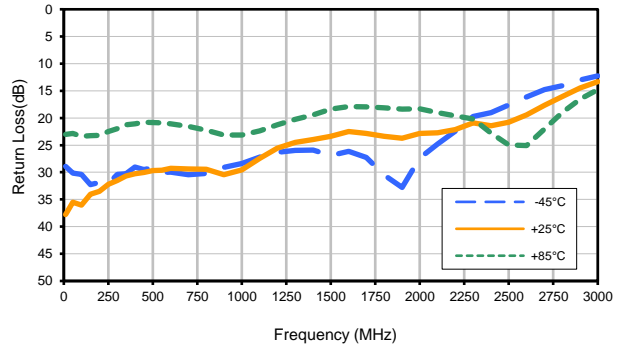

Output Return Loss(16dB)

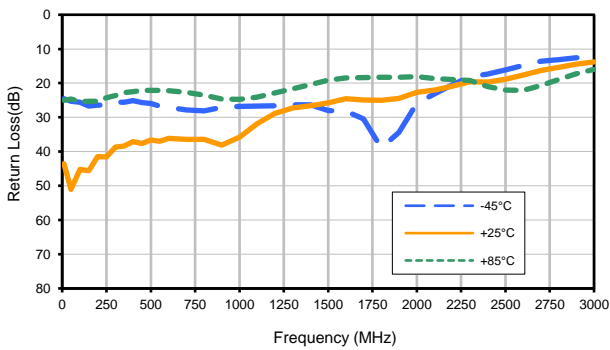

Output Return Loss (31dB)

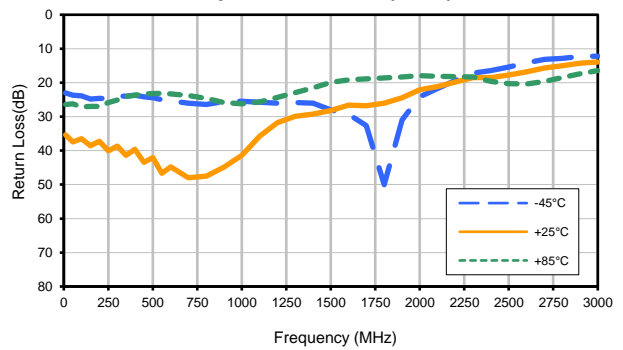

Outline Dimensions

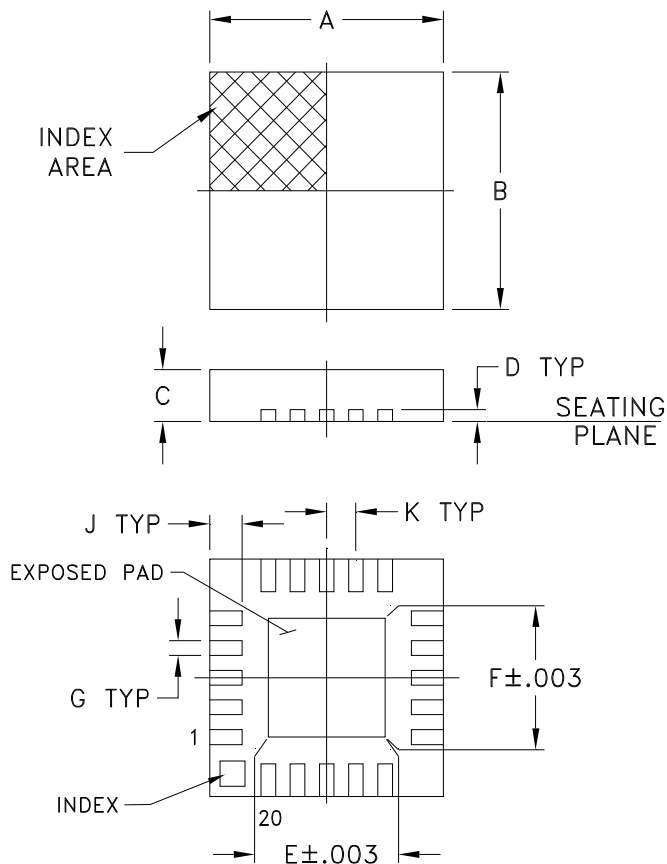

PCB Land Pattern

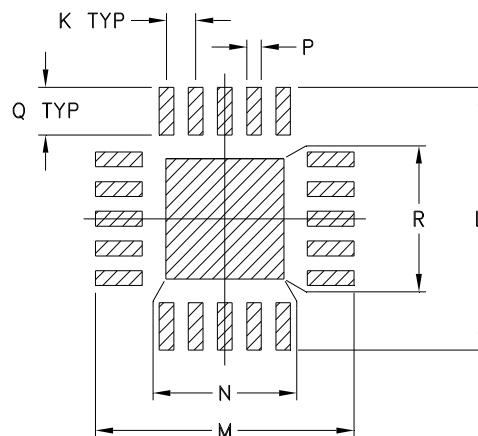

Suggested Layout,
Tolerance to be within $\pm .002$

CASE #	A	B	C	D	E	F	G	H	J	K
DG983-2	.157 (4.00)	.157 (4.00)	.033 (0.85)	.008 (0.20)	.085 (2.15)	.085 (2.15)	.009 (0.23)	-- --	.022 (0.55)	.020 (0.50)

CASE #	L	M	N	P	Q	R	WT. GRAM
DG983-2	.177 (4.50)	.177 (4.50)	.081 (2.06)	.010 (0.25)	.032 (0.81)	.081 (2.06)	.04

Dimensions are in inches (mm). Tolerances: 2 Pl. $\pm .01$; 3 Pl. $\pm .005$

Notes:

1. Case material: Plastic.
2. Termination finish:

For RoHS Case Styles: 0.2 μ inches of Gold (Au) over 0.1 μ inches of Palladium (Pd) over 10 μ inches of Nickel (Ni). All models, (+) suffix.

For RoHS-5 Case Styles: Tin-Lead plate. All models, no (+) suffix.



ISO 9001 ISO 14001 CERTIFIED



Tape & Reel Packaging TR-F87

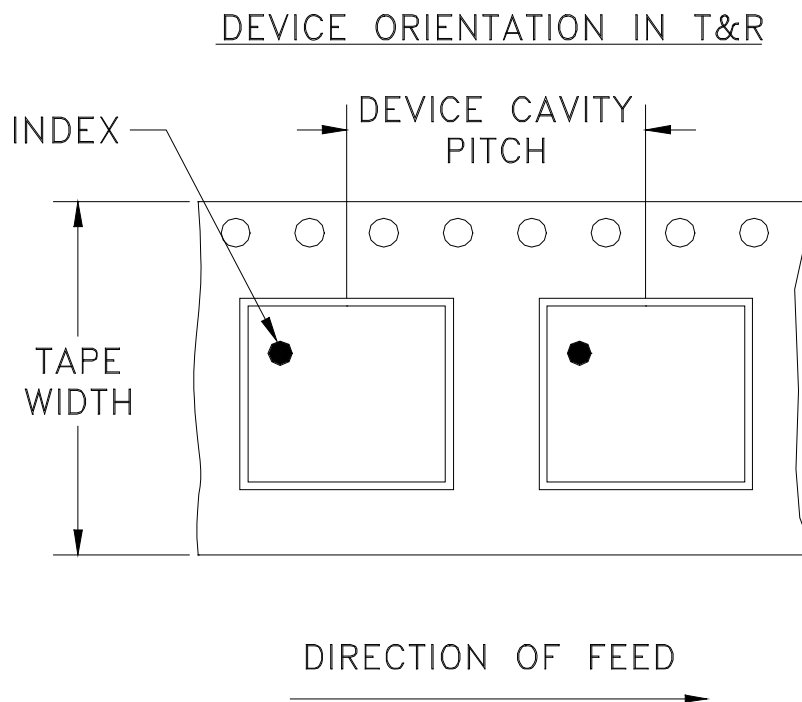

Tape Width, mm	Device Cavity Pitch, mm	Reel Size, inches	Devices per Reel	
12	8	7	Small quantity standards (see note)	20
				50
				100
				200
				500
		1000		
		13	Standard	3000

Note : Please Consult individual model data sheet to determine device per reel availability

Mini-Circuits carrier tape materials provide protection from ESD (Electro-Static Discharge) during handling and transportation. Tapes are static dissipative and comply with industry standards EIA-481/EIA-541.

Go to: www.minicircuits.com/pages/pdfs/tape.pdf

Mini-Circuits®

INTERNET <http://www.minicircuits.com>

P.O. Box 350166, Brooklyn, New York 11235-0003 (718) 934-4500 Fax (718) 332-4661

Distribution Centers NORTH AMERICA 800-654-7949 • 417-335-5935 • Fax 417-335-5945 • EUROPE 44-1252-832600 • Fax 44-1252-837010

Mini-Circuits ISO 9001 & ISO 14001 Certified

THIRD ANGLE PROJECTION

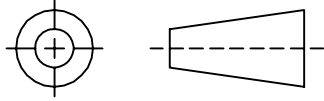

REVISIONS

REV	ECN No.	DESCRIPTION	DATE	DR	AUTH
OR	M97254	NEW RELEASE (FROM RAVON)	03/05	DK	HH
A	M102713	MODIFIED HATCH, NOTES & ADDED "...WITH SMOBC"	01/06	GT	HH
B	M103510	ADD R7 & CHANGE LOCATION DESIGNATORS	07/09	EM	KN
B	R63339	ADD R7 & CHANGE LOCATION DESIGNATORS	07/09	EM	KN

SUGGESTED MOUNTING CONFIGURATION

FOR DG983-1 CASE STYLE, qm PIN CONNECTION, 75 Ω.

KEEP-OUT ZONE,
.025 X.025, AVOID
TRACES IN THIS AREA
TO PREVENT SHORT TO
METAL INDEX ON BOTTOM
SIDE OF COMPONENT

.015±.002
LINE WIDTH
2 PL.
(SEE BELOW)

.023
To RFin

.023 TYP.

To Data
To Clock

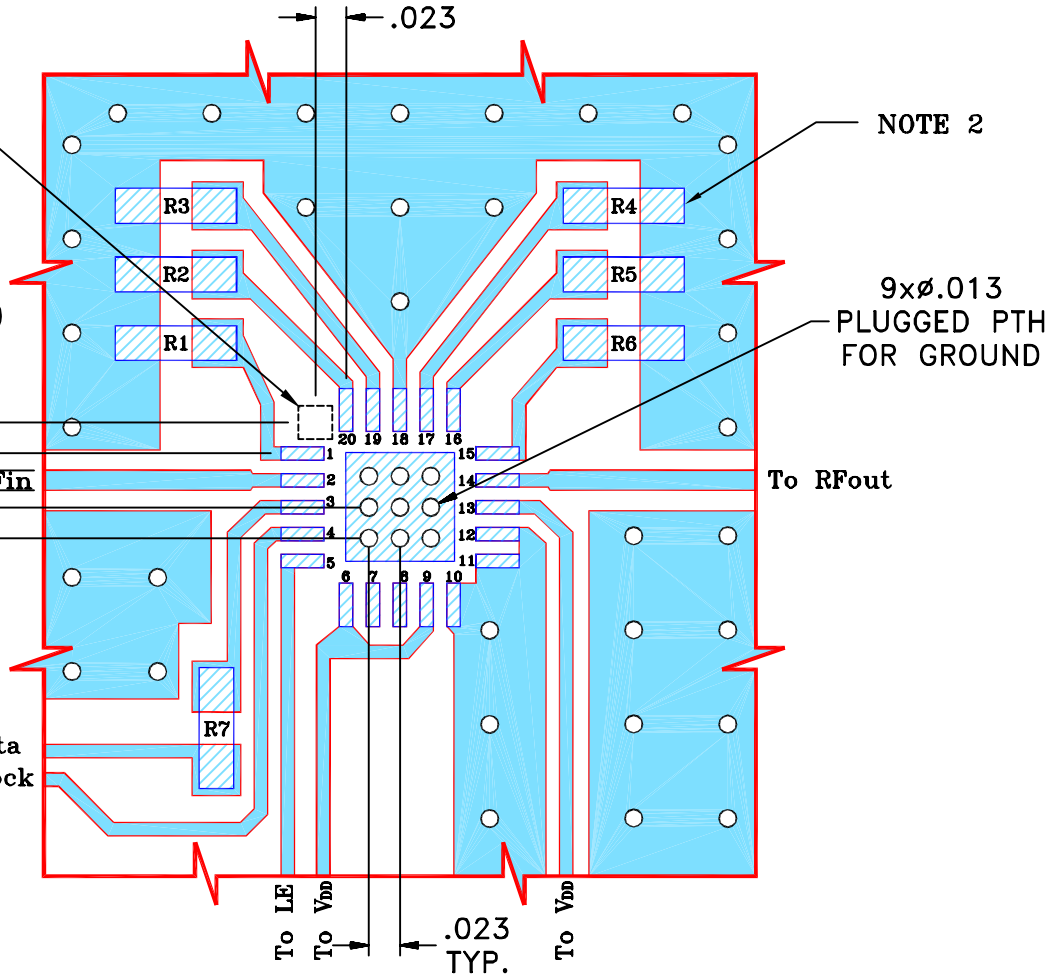

NOTE 2

9xø.013
PLUGGED PTH
FOR GROUND

To RFout

To LE
To Vdd
To Vss
.023 TYP.

NOTES:

1. TRACE WIDTH IS SHOWN FOR FR4 WITH DIELECTRIC THICKNESS .025"±.002". COPPER: 1/2 OZ. EACH SIDE. FOR OTHER MATERIALS TRACE WIDTH MAY NEED TO BE MODIFIED.
2. 0603 SIZE CHIP FOOT PRINTS SHOWN FOR REFERENCE, VALUES OF RESISTORS WILL VARY BASED ON APPLICATION.
3. BOTTOM SIDE OF THE PCB IS CONTINUOUS GROUND PLANE.



DENOTES PCB COPPER LAYOUT WITH SMOBC
(SOLDER MASK OVER BARE COPPER)

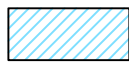

DENOTES COPPER LAND PATTERN FREE OF SOLDER MASK

UNLESS OTHERWISE SPECIFIED

DIMENSIONS ARE IN INCHES
TOLERANCES ON:
2 PL DECIMALS ±
3 PL DECIMALS ± .005
ANGLES ±
FRACTIONS ±

	INITIALS	DATE
DRAWN	DK (RAVON)	08 MAR 05
CHECKED	RZ (RAVON)	08 MAR 05
APPROVED	HH (RAVON)	08 MAR 05



Mini-Circuits® 13 Neptune Avenue
Brooklyn NY 11235

PL, qm, DG983-1
TB-344 (75 Ω)

THIS DOCUMENT AND ITS CONTENTS ARE THE PROPERTY OF MINI-CIRCUITS. EXCEPT FOR USE EXPRESSLY GRANTED, IN WRITING, TO ITS VENDORS, VENDEE AND THE UNITED STATES GOVERNMENT, MINI-CIRCUITS RESERVES ALL PROPRIETARY DESIGN, USE, MANUFACTURING AND REPRODUCTION RIGHTS THERETO. THESE CONTENTS SHALL NOT BE USED, DUPLICATED OR DISCLOSED TO ANY OUTSIDE PARTY, IN WHOLE OR IN PART, WITHOUT WRITTEN PERMISSION OF MINI-CIRCUITS.

SIZE	CODE IDENT	DRAWING NO:	REV:
A	15542	98-PL-203	B
FILE:	98PL203	SCALE: 7:1	SHEET: 1 OF 1

Evaluation Board and Circuit

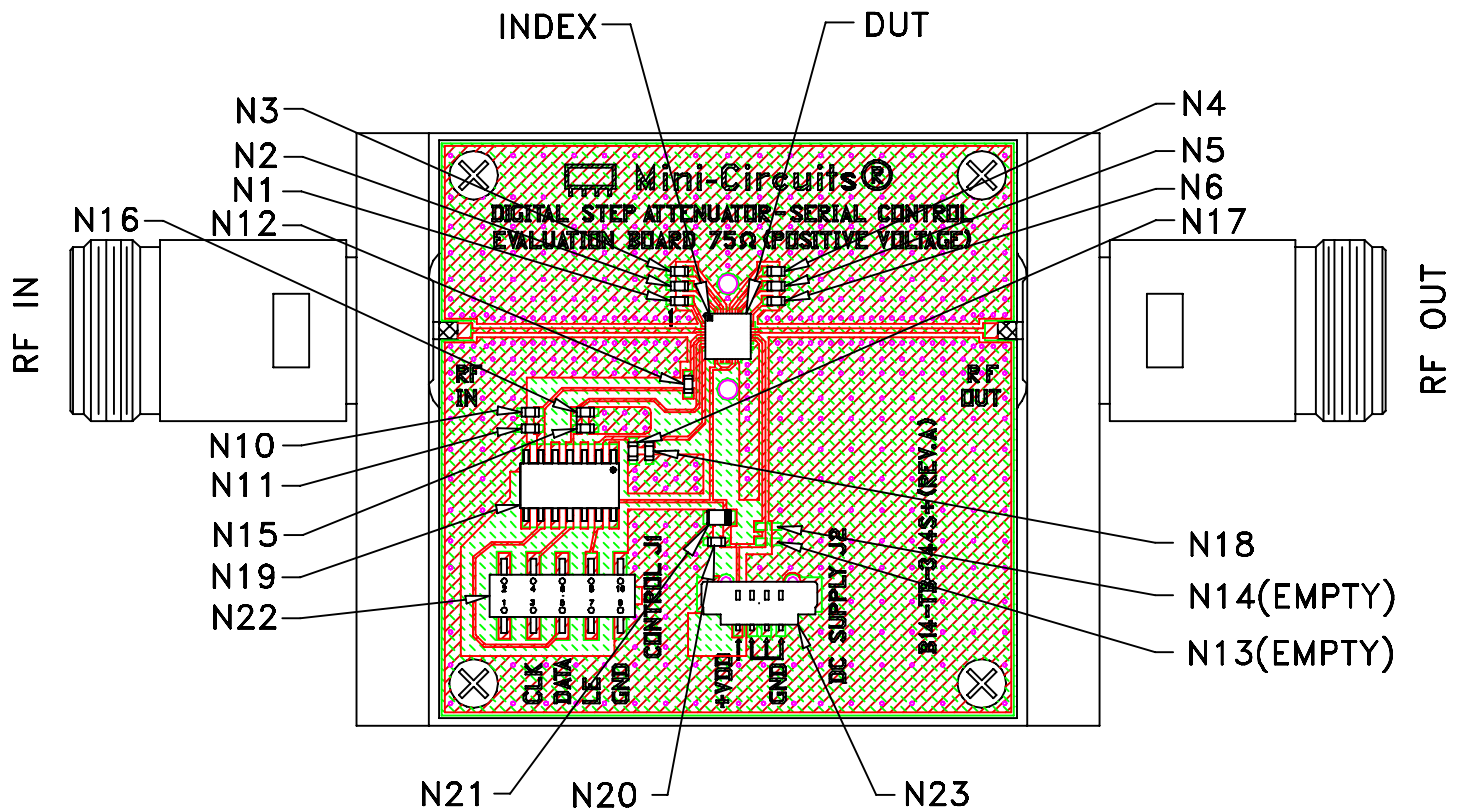

TB-344

Notes:

1. N-Type Female connectors.
2. PCB Material: FR4 Grade IT 180TC (ITEQ Corporation) or equivalent, Dielectric Constant=4.7, Thickness=.025 inch.

 **Mini-Circuits®**

All Mini-Circuits products are manufactured under exacting quality assurance and control standards, and are capable of meeting published specifications after being subjected to any or all of the following physical and environmental test.

Specification	Test/Inspection Condition	Reference/Spec
Operating Temperature	-40° to 85° C or -40° to 105° C Ambient Environment	Refer to Individual Model Data Sheet
Storage Temperature	-55° to 100° C or -65° to 150° C Ambient Environment	Refer to Individual Model Data Sheet
Temperature Humidity Bias	85°C, 85% RH, 96 hours	JESD22-A101B
Thermal Shock	-55° to 100°C, 100 cycles	MIL-STD-202, Method 107, Condition A-3, except +100°C
Solder Reflow Heat	Pb-Free Process: 260°C peak	J-STD-020, Table 4-1, 4-2 and 5-2; Figure 5-1
Solderability	10X magnification, 95% coverage	JESD22-B102, Method 1: Dip and Look Test
Marking Resistance to Solvents	Laser marked, visual observation	Mini-Circuits D4-Q4T0-04