

# Surface Mount Digital Step Attenuator

## DAT-3175A Series

75Ω 0 to 31 dB, 1.0 dB Step 1MHz to 2.5 GHz

### The Big Deal

- Wideband, operates up to 2.5 GHz
- Glitchless attenuation transitions
- High IP3, 52 dBm



CASE STYLE: DG983-2

### Product Overview

The DAT-3175A+ series of 75Ω digital step attenuators provides adjustable attenuation from 0 to 31 dB in 1 dB steps. The control is a 5-bit serial/parallel interface, and the attenuators operate with either single positive or dual (positive and negative) supply voltage. DAT-3175A+ series models are produced by a unique CMOS process on silicon, offering the performance of GaAs with the advantages of conventional CMOS devices.

### Key Features

| Feature  | Advantages  |
|--|---|
| Wideband operation, specified from 1MHz to 2.5 GHz   | Can be used in multiple applications such as various versions of DOCSIS, satellite and defense, reducing part count.  |
| Serial or parallel interface   | Models available with serial or parallel interface mode to suit customer demand.  |
| Good VSWR, 1.3:1 typ.  | Eases interfacing with adjacent components and results in low amplitude ripple.   |
| Single positive supply models:<br>(Model suffixes: -SP+ and -PP+)<br>+2.3 to +3.6V+                                | Use of single positive supply simplifies power supply design. An internal negative voltage generator supplies the desired negative voltage. Single positive supply results in excellent spurious performance, -140 dBm typical. |
| Dual supply models:<br>(Model suffixes: -SN+ and -PN+)<br>+2.7 to +3.6V (Positive) and<br>-3.6 to -3.2V (Negative) | Dual supply provides spurious-free operation. It also allows fast switching up to 1 MHz (vs. 25 kHz for single supply).   |
| Useable over a wide range of supply voltages, +2.3/2.7 to 5.2V   | Wide range of positive operating voltages allows the DAT-3175A+ Series of models to be used in a wide range of applications. See Application Note AN-70-032 for operation above +3.6V   |
| Footprint compatible to DAT-3175-XX+ Series (XX=SN/SP/PN/PP)   | Can fit into existing footprint and provide wideband performance, to 2.5 GHz instead of 2.0 GHz.  |
| Glitchless Attenuation Transitions, 0.26 typical   | Compared to previous generation of digital attenuators which is a vast improvement.   |



# Digital Step Attenuator

75Ω 1-2500 MHz

31 dB, 1.0 dB Step  
5 Bit, Parallel Control Interface, Single Supply Voltage

## Product Features

- Single positive supply voltage
- Immune to latch up
- Glitchless attenuation transitions
- Excellent accuracy, 0.1 dB Typ
- Low Insertion Loss
- High IP3, +55-59 dBm Typ
- Very low DC power consumption
- Excellent return loss, 18 dB Typ
- Small size 4.0 x 4.0 mm

## Typical Applications

- DOCSIS® 3.1
- Portable Wireless
- CATV & DBS
- MMDS & Wireless LAN
- Wireless Local Loop
- UNII & Hiper LAN
- Power amplifier distortion canceling loops



Generic photo used for illustration purposes only

## DAT-3175A-PP+

CASE STYLE: DG983-2

**+RoHS Compliant**

The +Suffix identifies RoHS Compliance. See our web site for RoHS Compliance methodologies and qualifications

## General Description

The DAT-3175A-PP+ is a 75Ω RF digital step attenuator that offers an attenuation range up to 31 dB in 1.0 dB steps. The control is a 5-bit parallel interface, operating on single (positive) supply voltage. The DAT-3175A-PP+ is produced using a unique CMOS process on silicon, offering the performance of GaAs, with the advantages of conventional CMOS devices.

## Simplified Schematic

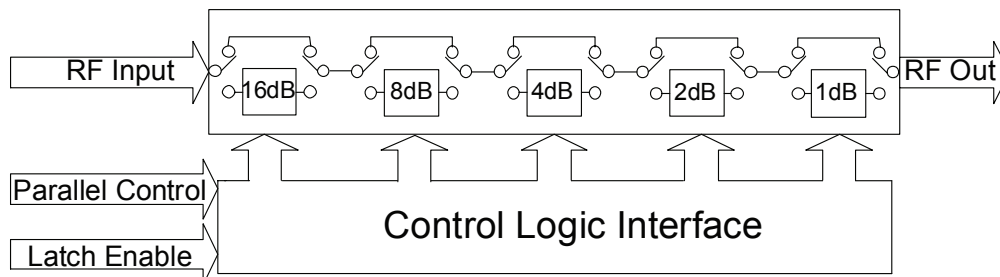

## RF Electrical Specifications, 1-2500 MHz, $T_{AMB}=25^{\circ}C$ , $V_{DD}=+3V$ , $75\Omega$

| Parameter  | Freq. Range (GHz) | Min. | Typ.       | Max.       | Units         |
|--|-------------------|------|------------|------------|---------------|
| Accuracy @ 1 dB Attenuation Setting                            | 0.001-1.2         | —    | 0.03       | 0.18       | dB            |
|  | 1.2-2.0           | —    | 0.1        | 0.20       |               |
|  | 2.0-2.5           | —    | 0.1        | 0.23       |               |
| Accuracy @ 2 dB Attenuation Setting                            | 0.001-1.2         | —    | 0.07       | 0.21       | dB            |
|  | 1.2-2.0           | —    | 0.15       | 0.26       |               |
|  | 2.0-2.5           | —    | 0.15       | 0.31       |               |
| Accuracy @ 4 dB Attenuation Setting                            | 0.001-1.2         | —    | 0.05       | 0.27       | dB            |
|  | 1.2-2.0           | —    | 0.15       | 0.36       |               |
|  | 2.0-2.5           | —    | 0.2        | 0.47       |               |
| Accuracy @ 8 dB Attenuation Setting                            | 0.001-1.2         | —    | 0.1        | 0.39       | dB            |
|  | 1.2-2.0           | —    | 0.24       | 0.60       |               |
|  | 2.0-2.5           | —    | 0.35       | 0.79       |               |
| Accuracy @ 16 dB Attenuation Setting                           | 0.001-1.2         | —    | 0.23       | 0.63       | dB            |
|  | 1.2-2.5           | —    | 0.8        | 1.0        |               |
|  | 2.0-2.5           | —    | 0.8        | 1.43       |               |
| Insertion Loss <sup>1</sup> @ all attenuator set to 0dB        | 0.001-1.2         | —    | 1.2        | 1.8        | dB            |
|  | 1.2-2.5           | —    | 1.6        | 1.9        |               |
| VSWR   | 0.001-1.2         | —    | 1.3        | —          | :1            |
|  | 1.2-2.5           | —    | 1.4        | —          |               |
| Input IP3 (at Min. and Max. Attenuation)                       | .005-2.5          | —    | 55-69      | —          | dBm           |
| Input IP2  | .005-2.5          | —    | See Fig. 1 | —          | dBm           |
| Input Power @ 0.1dB Compression (at Min. and Max. Attenuation) | 0.030-2.5         | —    | +30        | —          | dBm           |
| Input Operating Power  | 1 MHz to 30 MHz   | —    | —          | See Fig. 2 | dBm           |
|  | >30 MHz           | —    | —          | +24        |               |
| Thermal Resistance (Junction to case)                          | —                 | —    | 25         | —          | $^{\circ}C/W$ |

## DC Electrical Specifications

| Parameter               | Min. | Typ. | Max.             | Units   |
|-------------------------|------|------|------------------|---------|
| $V_{DD}$ Supply Voltage | 2.3  | 3    | 3.6 <sup>2</sup> | V       |
| $I_{DD}$ Supply Current | —    | —    | 200              | $\mu A$ |
| Control Input Low       | -0.3 | —    | 0.6 <sup>3</sup> | V       |
| Control Input High      | 1.17 | —    | 3.6              | V       |
| Control Current         | —    | —    | 20               | $\mu A$ |

1. I. Loss values are de-embedded from test board Loss (test board's Insertion Loss: 0.10dB @ 100MHz, 0.40dB @ 1200MHz, 0.55dB @ 2000MHz, 0.75dB @ 4000MHz).
2. For operation above +3.6V see application note, AN-70-032
3. 0 Volt during power up.

## Absolute Maximum Ratings<sup>4</sup>

| Parameter             | Ratings                            |
|-----------------------|------------------------------------|
| Operating Temperature | -40 $^{\circ}C$ to 105 $^{\circ}C$ |
| Storage Temperature   | -65 $^{\circ}C$ to 150 $^{\circ}C$ |
| $V_{DD}$              | -0.3V Min., 5.5V Max.              |
| Voltage on any input  | -0.3V Min., 3.6V Max.              |
| Input Power           | 1-30 MHz                           |
|                       | 30-2500 MHz                        |

4. Permanent damage may occur if any of these limits are exceeded.
5. Operation between max operating and absolute max input power will result in reduced reliability.

## Switching Specifications

| Parameter  | Min. | Typ. | Max. | Units     |
|--|------|------|------|-----------|
| Switching Speed, 50% Control to 90% or 10% of RF | —    | 0.4  | 0.7  | $\mu Sec$ |
| Switching Control Frequency                      | —    | —    | 25   | kHz       |

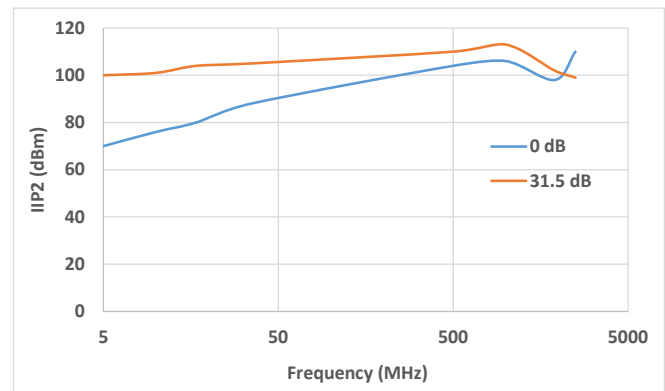

Fig 1. IP2 vs. Frequency and Attenuation

## Pin Description

| Function        | Pin Number | Description                                   |
|-----------------|------------|---|
| C16             | 1          | Control for Attenuation bit, 16dB (Note 3, 7) |
| RF in           | 2          | RF in port (Note 1)                           |
| N/C             | 3          | Not connected (Note 4)                        |
| GND             | 4          | Ground connection                             |
| LE              | 5          | Latch Enable Input (Note 2)                   |
| V <sub>DD</sub> | 6          | Positive Supply Voltage                       |
| PUP1            | 7          | Power-up selection (Note 7)                   |
| PUP2            | 8          | Power-up selection                            |
| V <sub>DD</sub> | 9          | Positive Supply Voltage                       |
| GND             | 10         | Ground connection                             |
| GND             | 11         | Ground connection                             |
| GND             | 12         | Ground connection (Note 6)                    |
| GND             | 13         | Ground connection                             |
| RF out          | 14         | RF out port (Note 1)                          |
| C8              | 15         | Control for attenuation bit, 8 dB             |
| C4              | 16         | Control for attenuation bit, 4 dB             |
| C2              | 17         | Control for attenuation bit, 2 dB             |
| GND             | 18         | Ground Connection                             |
| C1              | 19         | Control for attenuation bit, 1 dB             |
| N/C             | 20         | Not connected (Note 7)                        |
| GND             | Paddle     | Paddle ground (Note 5)                        |

### Notes:

- Both RF ports must be held at 0VDC or DC blocked with an external series capacitor.
- Latch Enable (LE) has an internal 2MΩ to internal positive supply voltage.
- Place a 10KΩ resistor in series to be compatible with previous generation of models. and 10KΩ maybe omitted in new designs.
- Place a shunt 10KΩ resistor to GND
- The exposed solder pad on the bottom of the package (See Pin configuration) must be grounded for proper device operation.
- Ground must be less than 80 mil (0.08") from Pin 12 for proper device operation.
- This pin has an internal 1MΩ resistor to ground.

## Pin Configuration (Top View)

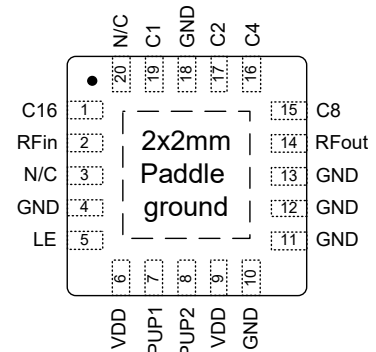

## Device Marking

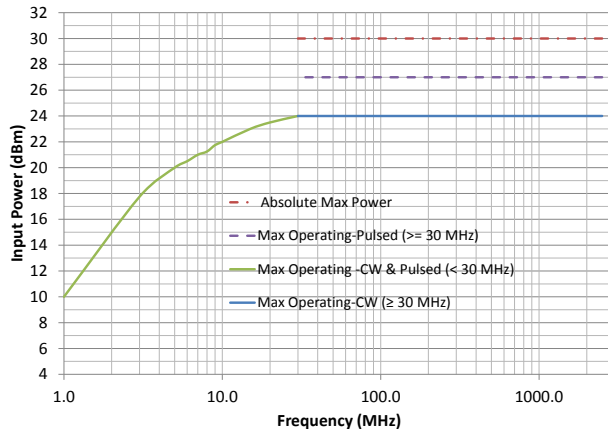
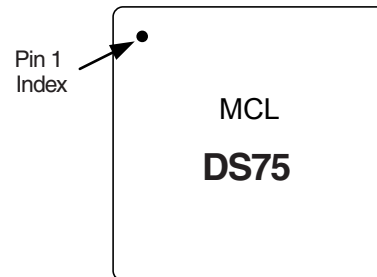

Pulsed Power: 5% duty cycle, 4620 μs period

## Simplified Schematic

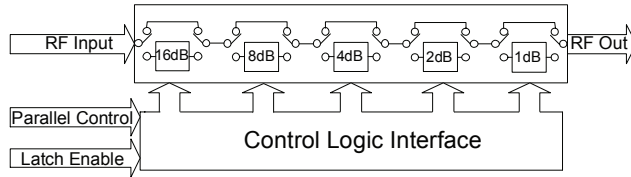

The DAT-3175A-PP+ parallel interface consists of 5 control bits that select the desired attenuation state, as shown in Table 1: Truth Table

| Attenuation State | C16 | C8 | C4 | C2 | C1 |
|-------------------|-----|----|----|----|----|
| Reference         | 0   | 0  | 0  | 0  | 0  |
| 1 (dB)            | 0   | 0  | 0  | 0  | 1  |
| 2 (dB)            | 0   | 0  | 0  | 1  | 0  |
| 4 (dB)            | 0   | 0  | 1  | 0  | 0  |
| 8 (dB)            | 0   | 1  | 0  | 0  | 0  |
| 16 (dB)           | 1   | 0  | 0  | 0  | 0  |
| 31 (dB)           | 1   | 1  | 1  | 1  | 1  |

Note: Not all 32 possible combinations of C1 - C16 are shown in table

The parallel interface timing requirements are defined by Fig. 3 (Parallel Interface Timing Diagram) and Table 2 (Parallel Interface AC Characteristics), and switching speed.

For latched parallel programming the Latch Enable (LE) should be held LOW while changing attenuation state control values, then pulse LE HIGH to LOW (per Figure 1) to latch new attenuation state into device.

For direct parallel programming, the Latch Enable (LE) line should be pulled HIGH. Changing attenuation state control values will change device state to new attenuation. Direct mode is ideal for manual control of the device (using hardware, switches, or jumpers).

Fig. 3: Parallel Interface Timing Diagram

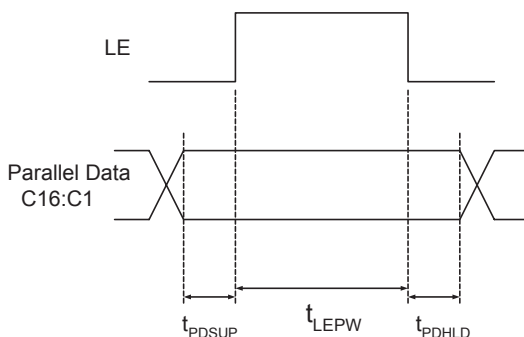

Table 2. Parallel Interface AC Characteristics

| Symbol      | Parameter                                       | Min. | Max. | Units |
|-------------|---|------|------|-------|
| $t_{LEPW}$  | LE minimum pulse width                          | 10   |      | ns    |
| $t_{PDSUP}$ | Data set-up time before clock rising edge of LE | 10   |      | ns    |
| $t_{PDHL}$  | Data hold time after clock falling edge of LE   | 10   |      | ns    |

## Power-up Control Settings

The DAT-3175A-PP+ always assumes a specifiable attenuation setting on power-up, allowing a known attenuation state to be established before an initial parallel control word is provided.

When the attenuator powers up with LE=0, the control bits are automatically set to one of four possible values. These four values are selected by the two power-up control bits, PUP1 and PUP2, as shown in Table 3: (Power-Up Truth Table, Parallel Mode).

| <b>Table 3. Power-Up Truth Table, Parallel Mode</b> |             |             |           |
|---|-------------|-------------|-----------|
| <b>Attenuation State</b>                            | <b>PUP1</b> | <b>PUP2</b> | <b>LE</b> |
| Reference   | 0           | 0           | 0         |
| 8 (dB)  | 0           | 1           | 0         |
| 16 (dB)   | 1           | 0           | 0         |
| 31 (dB)   | 1           | 1           | 0         |
| Defined by C1-C16<br>(See Table 1-Truth Table)      | X (Note 1)  | X (Note 1)  | 1         |

Note 1: PUP1 and PUP2 Connection may be 0, 1, GROUND, or not connect, without effect on attenuation state.

Power-Up with LE=1 provides normal parallel operation with C1-C16, and PUP1 and PUP2 are not active.

## TB-337 Evaluation Board Schematic Diagram

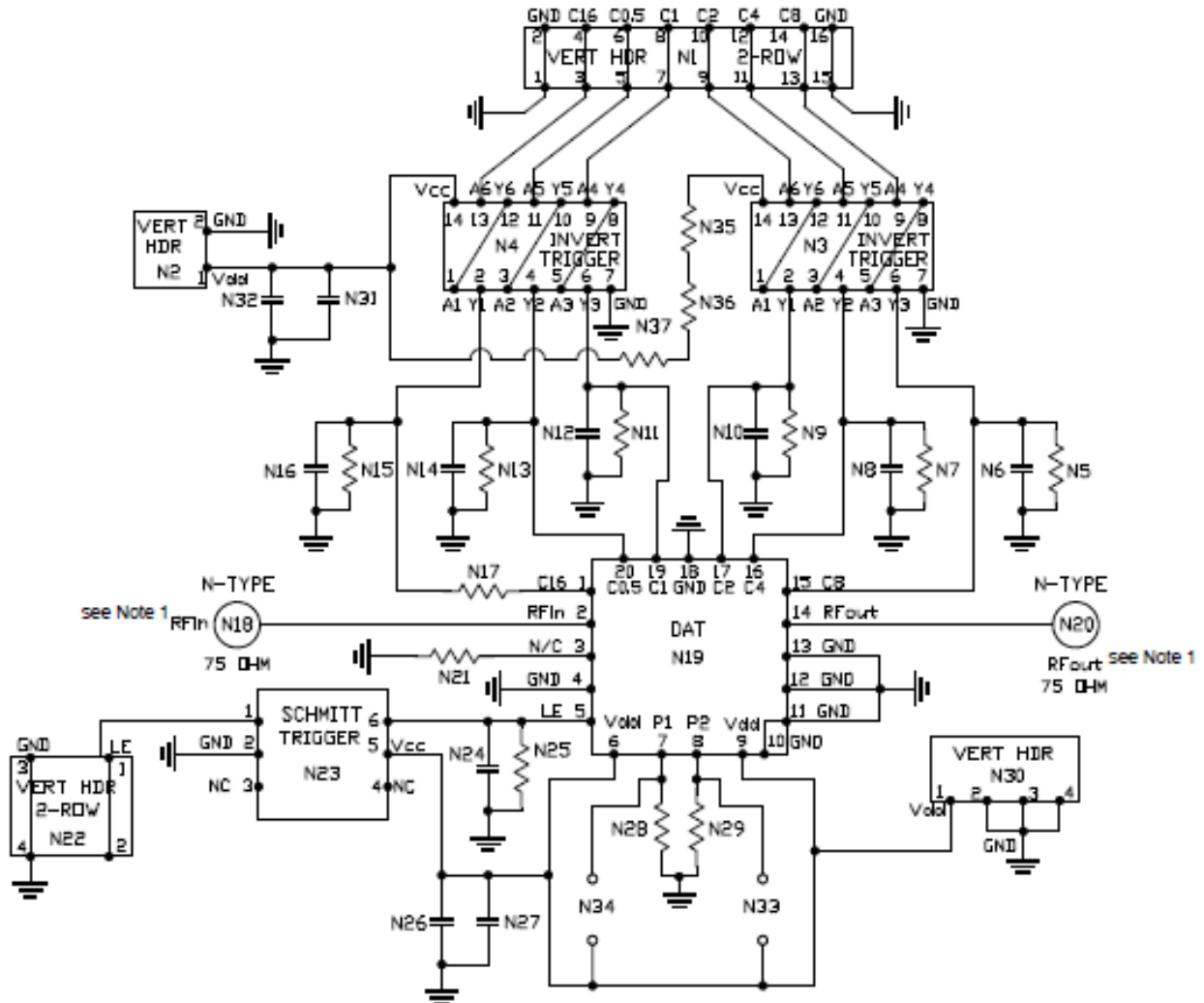

Note 1: Both RF ports must be held at 0VDC or DC blocked with an external series capacitor.

| Bill of Materials                          |  |
|--|--|
| N5, N7, N9, N11, N13, N15, N21 & N25       | Resistor 0603 10 KOhm +/- 1%           |
| N28 & N29                                  | Resistor 0603 475 Ohm +/- 1%           |
| N35-N37                                    | Resistor 0603 0 Ohm                    |
| N17  | Resistor 0402 10 KOhm +/- 1%           |
| N6, N8, N10, N12, N14, N16, N24, N26 & N32 | NPO Capacitor 0603 100pF +/- 5%        |
| N27 & N31                                  | Tantalum Capacitor 0805 100nF +/- 10%  |
| N3 & N4                                    | Hex Invert Schmitt Trigger MSL1        |
| N23  | Dual Schmitt Trigger Buffer SC-70 MSL1 |



TB-337

| Additional Detailed Technical Information   |   |
|---|---|
| <i>additional information is available on our dash board. To access this information <a href="#">click here</a></i> |   |
| <b>Performance Data</b>   | Data Table  |
|   | Swept Graphs  |
|   | S-Parameter (S2P Files) Data Set (.zip file)  |
| <b>Case Style</b>   | DG983-2 <i>Plastic package, exposed paddle, lead finish: NiPdAu</i>                                   |
| <b>Tape &amp; Reel</b><br>Standard quantities available on reel   | F87<br><i>7" reels with 20, 50, 100, 200, 500 Or 1000 devices</i><br><i>13" reels with 3K devices</i> |
| <b>Suggested Layout for PCB Design</b>  | PL-193  |
| <b>Evaluation Board</b>   | TB-337  |
| <b>Environmental Ratings</b>  | ENV33T1   |

## ESD Rating

Human Body Model (HBM): Class 1C (1000 to <2000V) in accordance with MIL-STD-883 method 3015  
Charge Device Model class C2 (500 to <1000V) per JESD22-C101

## MSL Rating

Moisture Sensitivity: MSL1 in accordance with IPC/JEDEC J-STD-020D

## MSL Test Flow Chart

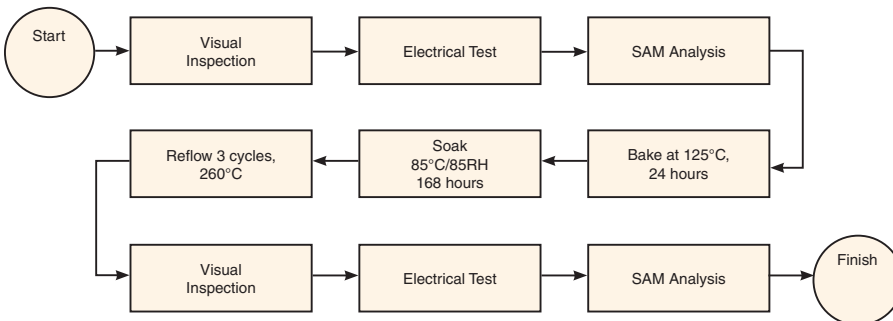

## Additional Notes

- Performance and quality attributes and conditions not expressly stated in this specification document are intended to be excluded and do not form a part of this specification document.
- Electrical specifications and performance data contained in this specification document are based on Mini-Circuit's applicable established test performance criteria and measurement instructions.
- The parts covered by this specification document are subject to Mini-Circuits standard limited warranty and terms and conditions (collectively, "Standard Terms"); Purchasers of this part are entitled to the rights and benefits contained therein. For a full statement of the Standard Terms and the exclusive rights and remedies thereunder, please visit Mini-Circuits' website at [www.minicircuits.com/MCLStore/terms.jsp](http://www.minicircuits.com/MCLStore/terms.jsp)



# Digital Step Attenuator

# DAT-3175A-PP+

## Typical Performance Data

TEST CONDITIONS: INPUT POWER=-10dBm, Vdd=+3V, TEMPERATURE=-45degC

| FREQUENCY<br>(MHz) | STEP ATTENUATION* AT TTL CONTROL STATE<br>(dB) |                 |                 |                 |                 |                |                |
|--------------------|--|-----------------|-----------------|-----------------|-----------------|----------------|----------------|
|                    | 00000<br>THRU LOSS                             | 00001<br>1.0 dB | 00010<br>2.0 dB | 00100<br>4.0 dB | 01000<br>8.0 dB | 10000<br>16 dB | 11111<br>31 dB |
| 10                 | 0.94   | 1.04            | 2.05            | 4.14            | 8.21            | 16.36          | 31.21          |
| 50                 | 0.94   | 1.05            | 2.06            | 4.13            | 8.21            | 16.27          | 31.42          |
| 100                | 0.94   | 1.05            | 2.05            | 4.12            | 8.20            | 16.28          | 31.44          |
| 150                | 0.95   | 1.05            | 2.05            | 4.12            | 8.19            | 16.26          | 31.43          |
| 200                | 0.96   | 1.05            | 2.05            | 4.12            | 8.20            | 16.26          | 31.38          |
| 250                | 0.96   | 1.05            | 2.06            | 4.12            | 8.20            | 16.27          | 31.40          |
| 300                | 0.96   | 1.05            | 2.05            | 4.13            | 8.20            | 16.28          | 31.40          |
| 350                | 0.96   | 1.05            | 2.05            | 4.13            | 8.21            | 16.28          | 31.40          |
| 400                | 0.97   | 1.05            | 2.05            | 4.13            | 8.20            | 16.28          | 31.41          |
| 450                | 0.98   | 1.05            | 2.05            | 4.13            | 8.20            | 16.27          | 31.42          |
| 500                | 1.00   | 1.04            | 2.05            | 4.12            | 8.19            | 16.26          | 31.44          |
| 550                | 1.02   | 1.04            | 2.04            | 4.11            | 8.18            | 16.25          | 31.43          |
| 600                | 1.04   | 1.04            | 2.04            | 4.10            | 8.17            | 16.25          | 31.43          |
| 700                | 1.06   | 1.03            | 2.04            | 4.10            | 8.16            | 16.24          | 31.41          |
| 800                | 1.10   | 1.03            | 2.03            | 4.08            | 8.13            | 16.20          | 31.28          |
| 900                | 1.12   | 1.03            | 2.03            | 4.08            | 8.14            | 16.22          | 31.44          |
| 1000               | 1.14   | 1.03            | 2.03            | 4.08            | 8.14            | 16.25          | 31.63          |
| 1100               | 1.17   | 1.02            | 2.02            | 4.07            | 8.14            | 16.24          | 31.61          |
| 1200               | 1.17   | 1.02            | 2.02            | 4.07            | 8.13            | 16.21          | 31.33          |
| 1300               | 1.17   | 1.02            | 2.02            | 4.07            | 8.12            | 16.15          | 30.72          |
| 1400               | 1.18   | 1.02            | 2.02            | 4.06            | 8.11            | 16.10          | 30.41          |
| 1500               | 1.21   | 1.02            | 2.02            | 4.07            | 8.14            | 16.18          | 30.97          |
| 1600               | 1.27   | 1.03            | 2.03            | 4.09            | 8.16            | 16.26          | 31.35          |
| 1700               | 1.29   | 1.03            | 2.03            | 4.10            | 8.17            | 16.26          | 31.15          |
| 1800               | 1.29   | 1.02            | 2.02            | 4.09            | 8.15            | 16.17          | 30.40          |
| 1900               | 1.28   | 1.02            | 2.02            | 4.10            | 8.16            | 16.15          | 30.17          |
| 2000               | 1.26   | 1.02            | 2.02            | 4.11            | 8.17            | 16.13          | 29.96          |
| 2100               | 1.23   | 1.03            | 2.03            | 4.13            | 8.19            | 16.11          | 29.65          |
| 2200               | 1.24   | 1.03            | 2.04            | 4.14            | 8.21            | 16.11          | 29.48          |
| 2300               | 1.27   | 1.04            | 2.05            | 4.17            | 8.28            | 16.22          | 30.11          |
| 2400               | 1.38   | 1.04            | 2.06            | 4.19            | 8.33            | 16.34          | 30.54          |
| 2500               | 1.43   | 1.04            | 2.05            | 4.18            | 8.32            | 16.24          | 29.86          |
| 2600               | 1.37   | 1.05            | 2.07            | 4.23            | 8.38            | 16.26          | 29.71          |
| 2700               | 1.25   | 1.06            | 2.09            | 4.30            | 8.46            | 16.32          | 29.53          |
| 2800               | 1.32   | 1.06            | 2.10            | 4.35            | 8.54            | 16.52          | 30.31          |
| 2900               | 1.67   | 1.04            | 2.07            | 4.34            | 8.56            | 16.74          | 31.55          |
| 3000               | 2.18   | 1.00            | 2.01            | 4.28            | 8.54            | 17.06          | 35.09          |

\* Step Attenuation above Thru Loss (TTL Logic 00000).



REV. OR  
DAT-3175A-PP+

10/11/2016

Page 1 of 9

# Digital Step Attenuator

# DAT-3175A-PP+

## Typical Performance Data

TEST CONDITIONS: INPUT POWER=-10dBm, Vdd=+3V, TEMPERATURE=-45degC

| FREQUENCY<br>(MHz) | INPUT RETURN LOSS AT TTL CONTROL STATE<br>(dB) |                 |                 |                 |                 |                |                |
|--------------------|--|-----------------|-----------------|-----------------|-----------------|----------------|----------------|
|                    | 00000<br>0 dB                                  | 00001<br>1.0 dB | 00010<br>2.0 dB | 00100<br>4.0 dB | 01000<br>8.0 dB | 10000<br>16 dB | 11111<br>31 dB |
| 10                 | 20.27  | 22.99           | 24.58           | 36.55           | 28.90           | 24.68          | 23.22          |
| 50                 | 19.95  | 22.64           | 24.26           | 38.02           | 29.48           | 25.18          | 23.56          |
| 100                | 19.98  | 22.58           | 24.15           | 37.33           | 29.78           | 25.46          | 23.81          |
| 150                | 19.79  | 22.26           | 23.73           | 38.80           | 30.85           | 26.22          | 24.50          |
| 200                | 19.78  | 22.24           | 23.69           | 39.57           | 31.04           | 26.34          | 24.57          |
| 250                | 19.61  | 22.07           | 23.55           | 41.31           | 31.42           | 26.53          | 24.68          |
| 300                | 19.63  | 22.19           | 23.71           | 38.60           | 30.49           | 25.95          | 24.23          |
| 350                | 19.56  | 22.09           | 23.63           | 36.68           | 30.05           | 25.75          | 24.10          |
| 400                | 19.58  | 22.08           | 23.65           | 33.29           | 28.94           | 25.28          | 23.73          |
| 450                | 19.46  | 21.92           | 23.39           | 32.08           | 28.77           | 25.39          | 23.88          |
| 500                | 19.42  | 21.78           | 23.15           | 30.50           | 28.25           | 25.32          | 23.89          |
| 550                | 19.36  | 21.66           | 22.98           | 30.41           | 28.58           | 25.74          | 24.28          |
| 600                | 19.33  | 21.55           | 22.77           | 29.65           | 28.34           | 25.86          | 24.45          |
| 700                | 19.43  | 21.54           | 22.67           | 29.23           | 28.24           | 26.09          | 24.76          |
| 800                | 19.34  | 21.34           | 22.35           | 28.24           | 27.60           | 25.97          | 24.82          |
| 900                | 19.04  | 20.96           | 21.88           | 27.21           | 26.75           | 25.58          | 24.63          |
| 1000               | 18.58  | 20.42           | 21.30           | 26.45           | 26.22           | 25.47          | 24.69          |
| 1100               | 18.13  | 19.87           | 20.67           | 25.90           | 26.10           | 25.92          | 25.32          |
| 1200               | 17.76  | 19.42           | 20.16           | 25.67           | 26.28           | 26.75          | 26.50          |
| 1300               | 17.37  | 18.96           | 19.64           | 25.79           | 26.94           | 28.40          | 28.64          |
| 1400               | 16.89  | 18.41           | 19.07           | 25.54           | 27.23           | 30.04          | 31.39          |
| 1500               | 16.71  | 18.21           | 18.88           | 25.89           | 28.38           | 32.99          | 36.12          |
| 1600               | 16.86  | 18.36           | 19.04           | 26.87           | 30.62           | 40.45          | 46.44          |
| 1700               | 17.73  | 19.21           | 19.83           | 28.13           | 31.79           | 33.03          | 30.61          |
| 1800               | 19.11  | 20.41           | 20.89           | 27.04           | 28.10           | 26.44          | 24.78          |
| 1900               | 20.27  | 21.16           | 21.50           | 24.08           | 24.29           | 22.82          | 21.57          |
| 2000               | 20.92  | 21.22           | 21.51           | 21.40           | 21.41           | 20.18          | 19.18          |
| 2100               | 21.01  | 20.76           | 20.98           | 19.24           | 19.15           | 18.14          | 17.28          |
| 2200               | 20.75  | 20.25           | 20.42           | 18.02           | 17.78           | 16.85          | 16.13          |
| 2300               | 23.19  | 22.16           | 22.12           | 18.19           | 17.51           | 16.48          | 15.77          |
| 2400               | 27.07  | 23.69           | 22.59           | 17.28           | 16.12           | 15.11          | 14.52          |
| 2500               | 26.58  | 22.49           | 20.84           | 15.87           | 14.50           | 13.60          | 13.14          |
| 2600               | 22.77  | 20.39           | 18.85           | 14.67           | 13.24           | 12.42          | 12.07          |
| 2700               | 19.11  | 18.47           | 17.47           | 14.00           | 12.55           | 11.78          | 11.47          |
| 2800               | 15.19  | 15.75           | 15.53           | 13.38           | 12.11           | 11.45          | 11.19          |
| 2900               | 12.35  | 13.30           | 13.58           | 12.69           | 11.83           | 11.36          | 11.16          |
| 3000               | 10.45  | 11.52           | 12.06           | 12.14           | 11.78           | 11.60          | 11.49          |



REV. OR  
DAT-3175A-PP+

10/11/2016

Page 2 of 9

P.O. Box 350166, Brooklyn, New York 11235-0003 (718) 934-4500 • Fax (718) 332-4661 For detailed performance specs & shopping online see Mini-Circuits web site  
The Design Engineers Search Engine Provides ACTUAL Data Instantly From MINI-CIRCUITS At: www.minicircuits.com

IF/RF MICROWAVE COMPONENTS

# Digital Step Attenuator

# DAT-3175A-PP+

## Typical Performance Data

TEST CONDITIONS: INPUT POWER=-10dBm, Vdd=+3V, TEMPERATURE=-45degC

| FREQUENCY<br>(MHz) | OUTPUT RETURN LOSS AT TTL CONTROL STATE<br>(dB) |                 |                 |                 |                 |                |                |
|--------------------|---|-----------------|-----------------|-----------------|-----------------|----------------|----------------|
|                    | 0000<br>0 dB                                    | 00001<br>1.0 dB | 00010<br>2.0 dB | 00100<br>4.0 dB | 01000<br>8.0 dB | 10000<br>16 dB | 11111<br>31 dB |
| 10                 | 20.05   | 22.44           | 24.36           | 28.47           | 29.16           | 24.78          | 23.18          |
| 50                 | 19.84   | 22.13           | 24.12           | 27.74           | 30.06           | 25.23          | 23.62          |
| 100                | 19.61   | 21.83           | 23.70           | 27.11           | 30.65           | 25.65          | 23.99          |
| 150                | 19.32   | 21.43           | 23.17           | 26.28           | 32.23           | 26.62          | 24.77          |
| 200                | 19.39   | 21.53           | 23.31           | 26.49           | 32.12           | 26.53          | 24.68          |
| 250                | 19.44   | 21.58           | 23.38           | 26.66           | 32.08           | 26.43          | 24.61          |
| 300                | 19.51   | 21.73           | 23.62           | 27.07           | 30.71           | 25.76          | 24.04          |
| 350                | 19.30   | 21.54           | 23.41           | 26.76           | 30.39           | 25.65          | 23.99          |
| 400                | 19.05   | 21.21           | 23.05           | 26.04           | 29.59           | 25.44          | 23.88          |
| 450                | 18.73   | 20.76           | 22.49           | 25.21           | 29.77           | 25.87          | 24.26          |
| 500                | 18.40   | 20.35           | 21.97           | 24.36           | 29.36           | 26.09          | 24.57          |
| 550                | 18.28   | 20.17           | 21.73           | 23.96           | 29.66           | 26.64          | 25.04          |
| 600                | 18.23   | 20.06           | 21.56           | 23.62           | 29.39           | 26.81          | 25.28          |
| 700                | 18.36   | 20.14           | 21.60           | 23.49           | 29.76           | 27.39          | 25.78          |
| 800                | 18.77   | 20.55           | 22.03           | 23.76           | 29.94           | 27.57          | 25.94          |
| 900                | 19.36   | 21.16           | 22.62           | 24.14           | 29.08           | 26.93          | 25.44          |
| 1000               | 19.54   | 21.24           | 22.59           | 23.67           | 27.84           | 26.36          | 25.11          |
| 1100               | 19.24   | 20.79           | 21.94           | 22.65           | 26.80           | 26.16          | 25.22          |
| 1200               | 19.35   | 20.80           | 21.90           | 22.39           | 26.60           | 26.31          | 25.51          |
| 1300               | 19.64   | 21.06           | 22.09           | 22.39           | 26.81           | 26.67          | 25.97          |
| 1400               | 19.63   | 20.96           | 21.93           | 22.11           | 27.08           | 27.34          | 26.86          |
| 1500               | 19.23   | 20.47           | 21.37           | 21.58           | 27.79           | 28.94          | 28.86          |
| 1600               | 18.30   | 19.37           | 20.14           | 20.49           | 27.62           | 30.75          | 32.69          |
| 1700               | 17.49   | 18.50           | 19.23           | 19.67           | 26.82           | 30.75          | 34.90          |
| 1800               | 17.18   | 18.22           | 18.99           | 19.79           | 28.02           | 33.67          | 41.27          |
| 1900               | 17.21   | 18.32           | 19.19           | 20.54           | 29.86           | 34.33          | 33.24          |
| 2000               | 17.42   | 18.62           | 19.61           | 21.84           | 29.56           | 28.74          | 26.60          |
| 2100               | 17.58   | 18.87           | 19.93           | 23.15           | 26.06           | 24.13          | 22.57          |
| 2200               | 18.38   | 19.80           | 20.92           | 25.21           | 23.10           | 21.04          | 19.80          |
| 2300               | 20.64   | 22.36           | 23.38           | 28.57           | 20.73           | 18.72          | 17.69          |
| 2400               | 27.11   | 29.67           | 28.59           | 28.18           | 18.59           | 16.85          | 15.99          |
| 2500               | 40.31   | 29.48           | 25.58           | 22.09           | 16.46           | 15.18          | 14.51          |
| 2600               | 29.63   | 25.31           | 22.64           | 19.20           | 15.03           | 13.95          | 13.43          |
| 2700               | 23.12   | 22.87           | 21.40           | 17.51           | 14.22           | 13.14          | 12.69          |
| 2800               | 16.46   | 17.55           | 17.84           | 15.47           | 13.55           | 12.61          | 12.24          |
| 2900               | 12.59   | 13.78           | 14.57           | 13.60           | 13.06           | 12.46          | 12.18          |
| 3000               | 10.45   | 11.60           | 12.52           | 12.32           | 12.90           | 12.75          | 12.61          |

# Digital Step Attenuator

# DAT-3175A-PP+

## Typical Performance Data

TEST CONDITIONS: INPUT POWER=-10dBm, Vdd=+3V, TEMPERATURE=+25degC

| FREQUENCY<br>(MHz) | STEP ATTENUATION* AT TTL CONTROL STATE<br>(dB) |                 |                 |                 |                 |                |                |
|--------------------|--|-----------------|-----------------|-----------------|-----------------|----------------|----------------|
|                    | 00000<br>THRU LOSS                             | 00001<br>1.0 dB | 00010<br>2.0 dB | 00100<br>4.0 dB | 01000<br>8.0 dB | 10000<br>16 dB | 11111<br>31 dB |
| 10                 | 1.08   | 1.02            | 2.02            | 4.03            | 8.03            | 16.09          | 30.91          |
| 50                 | 1.08   | 1.02            | 2.02            | 4.03            | 8.03            | 16.03          | 31.10          |
| 100                | 1.08   | 1.02            | 2.02            | 4.03            | 8.03            | 16.04          | 31.05          |
| 150                | 1.09   | 1.02            | 2.02            | 4.03            | 8.03            | 16.04          | 31.03          |
| 200                | 1.10   | 1.01            | 2.02            | 4.03            | 8.03            | 16.04          | 31.00          |
| 250                | 1.11   | 1.02            | 2.02            | 4.03            | 8.03            | 16.03          | 31.04          |
| 300                | 1.12   | 1.02            | 2.02            | 4.02            | 8.03            | 16.04          | 31.07          |
| 350                | 1.14   | 1.01            | 2.02            | 4.02            | 8.03            | 16.04          | 31.03          |
| 400                | 1.15   | 1.02            | 2.02            | 4.02            | 8.02            | 16.02          | 31.07          |
| 450                | 1.17   | 1.01            | 2.02            | 4.02            | 8.02            | 16.03          | 31.08          |
| 500                | 1.18   | 1.01            | 2.01            | 4.01            | 8.02            | 16.01          | 31.00          |
| 550                | 1.20   | 1.01            | 2.01            | 4.01            | 8.00            | 16.01          | 31.05          |
| 600                | 1.22   | 1.01            | 2.01            | 4.01            | 8.00            | 16.01          | 31.05          |
| 700                | 1.25   | 1.00            | 2.01            | 4.00            | 8.00            | 16.00          | 31.05          |
| 800                | 1.28   | 1.00            | 2.00            | 4.00            | 7.99            | 15.98          | 30.89          |
| 900                | 1.31   | 1.00            | 2.00            | 3.99            | 7.99            | 16.01          | 31.14          |
| 1000               | 1.35   | 1.00            | 2.00            | 3.99            | 8.00            | 16.04          | 31.39          |
| 1100               | 1.37   | 1.00            | 2.00            | 3.99            | 8.00            | 16.04          | 31.27          |
| 1200               | 1.39   | 1.00            | 2.00            | 3.99            | 7.99            | 16.00          | 30.93          |
| 1300               | 1.41   | 1.00            | 2.00            | 3.98            | 7.97            | 15.94          | 30.41          |
| 1400               | 1.43   | 0.99            | 1.99            | 3.98            | 7.96            | 15.92          | 30.35          |
| 1500               | 1.46   | 1.00            | 2.00            | 3.99            | 8.00            | 15.99          | 30.76          |
| 1600               | 1.52   | 1.00            | 2.00            | 4.01            | 8.02            | 16.04          | 30.96          |
| 1700               | 1.54   | 1.00            | 2.00            | 4.02            | 8.03            | 16.06          | 30.75          |
| 1800               | 1.54   | 1.00            | 2.00            | 4.02            | 8.03            | 15.97          | 30.07          |
| 1900               | 1.54   | 1.00            | 2.00            | 4.03            | 8.04            | 15.98          | 29.99          |
| 2000               | 1.54   | 1.00            | 2.00            | 4.04            | 8.05            | 15.96          | 29.80          |
| 2100               | 1.55   | 1.00            | 2.00            | 4.05            | 8.06            | 15.94          | 29.53          |
| 2200               | 1.58   | 1.00            | 2.00            | 4.05            | 8.08            | 15.94          | 29.46          |
| 2300               | 1.61   | 1.00            | 2.00            | 4.06            | 8.12            | 16.04          | 30.04          |
| 2400               | 1.57   | 1.00            | 2.01            | 4.08            | 8.16            | 16.08          | 30.12          |
| 2500               | 1.40   | 1.00            | 2.01            | 4.10            | 8.17            | 16.00          | 29.42          |
| 2600               | 1.31   | 1.01            | 2.02            | 4.14            | 8.23            | 16.05          | 29.37          |
| 2700               | 1.30   | 1.01            | 2.02            | 4.17            | 8.26            | 16.07          | 29.26          |
| 2800               | 1.48   | 1.00            | 2.02            | 4.19            | 8.31            | 16.25          | 30.09          |
| 2900               | 1.85   | 0.98            | 1.99            | 4.18            | 8.33            | 16.47          | 31.64          |
| 3000               | 2.34   | 0.95            | 1.95            | 4.14            | 8.31            | 16.71          | 34.79          |

\* Step Attenuation above Thru Loss (TTL Logic 00000).



REV. OR  
DAT-3175A-PP+

10/11/2016

Page 4 of 9

P.O. Box 350166, Brooklyn, New York 11235-0003 (718) 934-4500 • Fax (718) 332-4661 For detailed performance specs & shopping online see Mini-Circuits web site  
The Design Engineers Search Engine Provides ACTUAL Data Instantly From MINI-CIRCUITS At: www.minicircuits.com

IF/RF MICROWAVE COMPONENTS

# Digital Step Attenuator

# DAT-3175A-PP+

## Typical Performance Data

TEST CONDITIONS: INPUT POWER=-10dBm, Vdd=+3V, TEMPERATURE=+25degC

| FREQUENCY<br>(MHz) | INPUT RETURN LOSS AT TTL CONTROL STATE<br>(dB) |                 |                 |                 |                 |                |                |
|--------------------|--|-----------------|-----------------|-----------------|-----------------|----------------|----------------|
|                    | 0000<br>0 dB                                   | 00001<br>1.0 dB | 00010<br>2.0 dB | 00100<br>4.0 dB | 01000<br>8.0 dB | 10000<br>16 dB | 11111<br>31 dB |
| 10                 | 19.01  | 20.54           | 21.19           | 32.11           | 37.76           | 46.88          | 37.04          |
| 50                 | 18.92  | 20.43           | 21.09           | 31.44           | 36.72           | 50.43          | 37.48          |
| 100                | 18.83  | 20.33           | 21.02           | 31.25           | 36.37           | 47.65          | 37.42          |
| 150                | 18.76  | 20.24           | 20.90           | 30.54           | 35.08           | 45.21          | 38.26          |
| 200                | 18.64  | 20.11           | 20.78           | 30.06           | 34.17           | 42.69          | 38.37          |
| 250                | 18.56  | 20.00           | 20.66           | 29.54           | 33.16           | 41.13          | 39.16          |
| 300                | 18.49  | 19.92           | 20.55           | 29.06           | 32.47           | 39.42          | 39.01          |
| 350                | 18.43  | 19.82           | 20.44           | 28.63           | 31.70           | 38.48          | 39.84          |
| 400                | 18.44  | 19.81           | 20.40           | 28.41           | 31.27           | 37.56          | 39.37          |
| 450                | 18.48  | 19.85           | 20.43           | 28.35           | 31.09           | 37.53          | 40.57          |
| 500                | 18.56  | 19.91           | 20.47           | 28.32           | 30.91           | 37.19          | 40.68          |
| 550                | 18.61  | 19.96           | 20.51           | 28.33           | 30.90           | 37.31          | 42.15          |
| 600                | 18.69  | 20.03           | 20.53           | 28.31           | 30.73           | 36.96          | 41.55          |
| 700                | 18.83  | 20.16           | 20.63           | 28.29           | 30.48           | 36.20          | 40.45          |
| 800                | 18.77  | 20.07           | 20.52           | 27.65           | 29.34           | 33.82          | 37.05          |
| 900                | 18.57  | 19.84           | 20.27           | 26.72           | 28.03           | 31.49          | 33.78          |
| 1000               | 18.11  | 19.34           | 19.75           | 25.61           | 26.73           | 29.76          | 31.98          |
| 1100               | 17.46  | 18.64           | 19.01           | 24.42           | 25.40           | 28.31          | 30.88          |
| 1200               | 16.84  | 17.93           | 18.28           | 23.30           | 24.24           | 26.96          | 29.62          |
| 1300               | 16.35  | 17.35           | 17.64           | 22.38           | 23.23           | 25.66          | 28.11          |
| 1400               | 15.98  | 16.90           | 17.14           | 21.66           | 22.38           | 24.44          | 26.46          |
| 1500               | 16.01  | 16.88           | 17.07           | 21.60           | 22.28           | 24.08          | 25.74          |
| 1600               | 16.35  | 17.13           | 17.27           | 21.76           | 22.38           | 23.67          | 24.69          |
| 1700               | 17.07  | 17.72           | 17.78           | 21.88           | 22.36           | 22.84          | 23.07          |
| 1800               | 17.95  | 18.36           | 18.36           | 21.50           | 21.90           | 21.66          | 21.34          |
| 1900               | 18.69  | 18.82           | 18.82           | 20.65           | 21.08           | 20.45          | 19.83          |
| 2000               | 19.16  | 19.03           | 19.09           | 19.59           | 20.09           | 19.31          | 18.53          |
| 2100               | 19.30  | 18.97           | 19.16           | 18.49           | 18.99           | 18.19          | 17.39          |
| 2200               | 19.27  | 18.91           | 19.16           | 17.88           | 18.31           | 17.53          | 16.73          |
| 2300               | 21.05  | 20.48           | 20.77           | 18.37           | 18.56           | 17.59          | 16.74          |
| 2400               | 24.26  | 23.01           | 23.04           | 18.82           | 18.42           | 17.29          | 16.42          |
| 2500               | 32.75  | 26.89           | 25.35           | 18.53           | 17.37           | 16.26          | 15.55          |
| 2600               | 27.67  | 25.51           | 23.51           | 17.56           | 16.04           | 15.08          | 14.53          |
| 2700               | 20.47  | 20.98           | 20.21           | 16.57           | 14.98           | 14.19          | 13.78          |
| 2800               | 15.91  | 16.97           | 17.04           | 15.51           | 14.24           | 13.67          | 13.38          |
| 2900               | 12.98  | 14.15           | 14.59           | 14.50           | 13.74           | 13.48          | 13.30          |
| 3000               | 11.00  | 12.15           | 12.76           | 13.63           | 13.45           | 13.59          | 13.59          |

# Digital Step Attenuator

# DAT-3175A-PP+

## Typical Performance Data

TEST CONDITIONS: INPUT POWER=-10dBm, Vdd=+3V, TEMPERATURE=+25degC

| FREQUENCY<br>(MHz) | OUTPUT RETURN LOSS AT TTL CONTROL STATE<br>(dB) |                 |                 |                 |                 |                |                |
|--------------------|---|-----------------|-----------------|-----------------|-----------------|----------------|----------------|
|                    | 0000<br>0 dB                                    | 00001<br>1.0 dB | 00010<br>2.0 dB | 00100<br>4.0 dB | 01000<br>8.0 dB | 10000<br>16 dB | 11111<br>31 dB |
| 10                 | 18.83   | 20.01           | 21.10           | 22.20           | 36.70           | 49.59          | 36.94          |
| 50                 | 18.87   | 20.10           | 21.07           | 22.09           | 36.02           | 49.41          | 37.13          |
| 100                | 18.67   | 19.92           | 20.89           | 21.99           | 35.26           | 47.13          | 37.34          |
| 150                | 18.57   | 19.78           | 20.75           | 21.78           | 34.08           | 44.73          | 38.27          |
| 200                | 18.39   | 19.60           | 20.55           | 21.62           | 33.26           | 42.58          | 38.36          |
| 250                | 18.29   | 19.49           | 20.41           | 21.41           | 32.32           | 41.31          | 39.49          |
| 300                | 18.13   | 19.32           | 20.24           | 21.21           | 31.55           | 39.33          | 39.46          |
| 350                | 18.01   | 19.15           | 20.06           | 20.97           | 30.74           | 38.31          | 40.77          |
| 400                | 17.85   | 18.99           | 19.87           | 20.76           | 30.07           | 37.01          | 40.68          |
| 450                | 17.76   | 18.88           | 19.75           | 20.58           | 29.59           | 36.43          | 41.87          |
| 500                | 17.70   | 18.80           | 19.64           | 20.45           | 29.19           | 35.74          | 41.57          |
| 550                | 17.70   | 18.78           | 19.63           | 20.39           | 29.00           | 35.52          | 42.33          |
| 600                | 17.78   | 18.84           | 19.68           | 20.38           | 28.97           | 35.37          | 42.55          |
| 700                | 18.03   | 19.11           | 19.93           | 20.56           | 29.39           | 36.39          | 46.24          |
| 800                | 18.37   | 19.46           | 20.28           | 20.81           | 29.86           | 37.42          | 48.18          |
| 900                | 18.73   | 19.81           | 20.63           | 21.01           | 30.14           | 37.60          | 44.82          |
| 1000               | 18.84   | 19.89           | 20.68           | 20.85           | 29.29           | 35.44          | 40.22          |
| 1100               | 18.68   | 19.66           | 20.38           | 20.38           | 27.67           | 32.17          | 35.70          |
| 1200               | 18.54   | 19.43           | 20.08           | 19.89           | 26.39           | 30.13          | 33.33          |
| 1300               | 18.43   | 19.22           | 19.76           | 19.43           | 25.49           | 28.83          | 32.06          |
| 1400               | 18.30   | 18.95           | 19.39           | 18.93           | 24.64           | 27.49          | 30.52          |
| 1500               | 18.06   | 18.57           | 18.91           | 18.46           | 23.83           | 26.18          | 28.73          |
| 1600               | 17.35   | 17.76           | 18.03           | 17.69           | 22.47           | 24.26          | 26.04          |
| 1700               | 16.88   | 17.26           | 17.54           | 17.35           | 21.91           | 23.50          | 24.91          |
| 1800               | 16.62   | 17.02           | 17.37           | 17.46           | 21.99           | 23.36          | 24.36          |
| 1900               | 16.53   | 17.02           | 17.42           | 17.89           | 22.38           | 23.42          | 23.82          |
| 2000               | 16.65   | 17.24           | 17.74           | 18.78           | 22.94           | 23.37          | 23.02          |
| 2100               | 17.06   | 17.73           | 18.32           | 20.05           | 23.14           | 22.66          | 21.71          |
| 2200               | 18.45   | 19.19           | 19.79           | 22.43           | 23.15           | 21.69          | 20.49          |
| 2300               | 21.22   | 21.93           | 22.40           | 26.71           | 22.47           | 20.48          | 19.22          |
| 2400               | 26.08   | 26.47           | 26.25           | 33.37           | 21.04           | 19.15          | 18.00          |
| 2500               | 32.28   | 30.88           | 28.42           | 28.05           | 19.20           | 17.63          | 16.71          |
| 2600               | 36.88   | 36.94           | 29.97           | 23.57           | 17.90           | 16.48          | 15.73          |
| 2700               | 22.46   | 24.06           | 24.21           | 19.57           | 16.71           | 15.48          | 14.90          |
| 2800               | 16.44   | 17.75           | 18.62           | 16.40           | 15.60           | 14.76          | 14.33          |
| 2900               | 12.90   | 14.07           | 15.03           | 14.08           | 14.69           | 14.40          | 14.17          |
| 3000               | 10.84   | 11.91           | 12.88           | 12.57           | 14.20           | 14.50          | 14.51          |

# Digital Step Attenuator

# DAT-3175A-PP+

## Typical Performance Data

TEST CONDITIONS: INPUT POWER=-10dBm, Vdd=+3V,, TEMPERATURE=+105degC

| FREQUENCY<br>(MHz) | STEP ATTENUATION* AT TTL CONTROL STATE<br>(dB) |                 |                 |                 |                 |                |                |
|--------------------|--|-----------------|-----------------|-----------------|-----------------|----------------|----------------|
|                    | 00000<br>THRU LOSS                             | 00001<br>1.0 dB | 00010<br>2.0 dB | 00100<br>4.0 dB | 01000<br>8.0 dB | 10000<br>16 dB | 11111<br>31 dB |
| 10                 | 1.26   | 0.99            | 2.00            | 3.94            | 7.88            | 15.76          | 30.66          |
| 50                 | 1.25   | 0.99            | 2.00            | 3.94            | 7.87            | 15.81          | 30.67          |
| 100                | 1.25   | 0.99            | 2.00            | 3.94            | 7.88            | 15.81          | 30.67          |
| 150                | 1.26   | 1.00            | 2.00            | 3.95            | 7.89            | 15.82          | 30.62          |
| 200                | 1.27   | 0.99            | 2.00            | 3.95            | 7.88            | 15.82          | 30.64          |
| 250                | 1.29   | 0.99            | 2.00            | 3.94            | 7.88            | 15.80          | 30.65          |
| 300                | 1.32   | 0.99            | 2.00            | 3.94            | 7.88            | 15.80          | 30.62          |
| 350                | 1.35   | 0.99            | 1.99            | 3.93            | 7.87            | 15.78          | 30.64          |
| 400                | 1.38   | 0.99            | 1.99            | 3.93            | 7.87            | 15.79          | 30.65          |
| 450                | 1.40   | 0.99            | 1.99            | 3.93            | 7.86            | 15.78          | 30.67          |
| 500                | 1.42   | 0.98            | 1.99            | 3.93            | 7.86            | 15.78          | 30.64          |
| 550                | 1.43   | 0.99            | 1.99            | 3.93            | 7.86            | 15.79          | 30.60          |
| 600                | 1.45   | 0.99            | 1.99            | 3.93            | 7.86            | 15.79          | 30.66          |
| 700                | 1.47   | 0.99            | 1.99            | 3.93            | 7.87            | 15.79          | 30.63          |
| 800                | 1.51   | 0.98            | 1.99            | 3.93            | 7.86            | 15.79          | 30.64          |
| 900                | 1.54   | 0.98            | 1.99            | 3.93            | 7.88            | 15.82          | 30.81          |
| 1000               | 1.59   | 0.98            | 1.99            | 3.93            | 7.88            | 15.85          | 30.97          |
| 1100               | 1.63   | 0.98            | 1.99            | 3.93            | 7.88            | 15.85          | 30.86          |
| 1200               | 1.68   | 0.98            | 1.98            | 3.92            | 7.87            | 15.81          | 30.55          |
| 1300               | 1.71   | 0.98            | 1.98            | 3.92            | 7.85            | 15.74          | 30.12          |
| 1400               | 1.75   | 0.98            | 1.98            | 3.93            | 7.86            | 15.75          | 30.15          |
| 1500               | 1.81   | 0.98            | 1.99            | 3.94            | 7.89            | 15.83          | 30.59          |
| 1600               | 1.87   | 0.98            | 1.99            | 3.96            | 7.92            | 15.88          | 30.71          |
| 1700               | 1.89   | 0.98            | 1.99            | 3.96            | 7.93            | 15.87          | 30.39          |
| 1800               | 1.90   | 0.98            | 1.99            | 3.96            | 7.93            | 15.80          | 29.88          |
| 1900               | 1.88   | 0.98            | 1.99            | 3.97            | 7.95            | 15.83          | 29.86          |
| 2000               | 1.85   | 0.98            | 1.99            | 3.97            | 7.95            | 15.81          | 29.63          |
| 2100               | 1.80   | 0.97            | 1.98            | 3.97            | 7.97            | 15.80          | 29.46          |
| 2200               | 1.74   | 0.98            | 1.98            | 3.98            | 7.98            | 15.81          | 29.39          |
| 2300               | 1.65   | 0.98            | 1.98            | 4.00            | 8.03            | 15.90          | 29.96          |
| 2400               | 1.53   | 0.97            | 1.98            | 4.02            | 8.05            | 15.89          | 29.63          |
| 2500               | 1.41   | 0.97            | 1.97            | 4.02            | 8.03            | 15.77          | 28.77          |
| 2600               | 1.42   | 0.96            | 1.97            | 4.03            | 8.05            | 15.79          | 28.96          |
| 2700               | 1.49   | 0.96            | 1.96            | 4.04            | 8.07            | 15.80          | 29.04          |
| 2800               | 1.71   | 0.95            | 1.95            | 4.04            | 8.09            | 15.93          | 29.70          |
| 2900               | 2.09   | 0.93            | 1.93            | 4.04            | 8.11            | 16.13          | 31.12          |
| 3000               | 2.55   | 0.91            | 1.90            | 4.02            | 8.11            | 16.36          | 33.72          |

\* Step Attenuation above Thru Loss (TTL Logic 00000).



REV. OR  
DAT-3175A-PP+

10/11/2016

Page 7 of 9

# Digital Step Attenuator

# DAT-3175A-PP+

## Typical Performance Data

TEST CONDITIONS: INPUT POWER=-10dBm, Vdd=+3V,TEMPERATURE=+105degC

| FREQUENCY<br>(MHz) | INPUT RETURN LOSS AT TTL CONTROL STATE<br>(dB) |                 |                 |                 |                 |                |                |
|--------------------|--|-----------------|-----------------|-----------------|-----------------|----------------|----------------|
|                    | 00000<br>0 dB                                  | 00001<br>1.0 dB | 00010<br>2.0 dB | 00100<br>4.0 dB | 01000<br>8.0 dB | 10000<br>16 dB | 11111<br>31 dB |
| 10                 | 17.84  | 18.38           | 18.51           | 23.12           | 23.28           | 24.80          | 26.64          |
| 50                 | 17.60  | 18.19           | 18.25           | 22.85           | 22.99           | 24.55          | 26.09          |
| 100                | 17.68  | 18.34           | 18.43           | 23.17           | 23.43           | 25.14          | 26.84          |
| 150                | 17.45  | 18.12           | 18.24           | 22.90           | 23.23           | 24.96          | 26.55          |
| 200                | 17.49  | 18.18           | 18.31           | 23.01           | 23.36           | 25.12          | 26.81          |
| 250                | 17.30  | 17.96           | 18.08           | 22.52           | 22.81           | 24.43          | 25.96          |
| 300                | 17.29  | 17.94           | 18.03           | 22.31           | 22.52           | 24.00          | 25.51          |
| 350                | 17.17  | 17.74           | 17.80           | 21.86           | 21.95           | 23.31          | 24.63          |
| 400                | 17.24  | 17.78           | 17.79           | 21.75           | 21.77           | 22.98          | 24.27          |
| 450                | 17.27  | 17.77           | 17.73           | 21.60           | 21.50           | 22.60          | 23.76          |
| 500                | 17.41  | 17.88           | 17.81           | 21.65           | 21.48           | 22.55          | 23.68          |
| 550                | 17.52  | 17.96           | 17.86           | 21.70           | 21.46           | 22.46          | 23.53          |
| 600                | 17.68  | 18.12           | 18.02           | 21.93           | 21.68           | 22.66          | 23.78          |
| 700                | 18.06  | 18.52           | 18.40           | 22.56           | 22.29           | 23.32          | 24.48          |
| 800                | 18.27  | 18.80           | 18.71           | 23.18           | 22.93           | 24.15          | 25.50          |
| 900                | 18.15  | 18.78           | 18.73           | 23.35           | 23.18           | 24.66          | 26.29          |
| 1000               | 17.57  | 18.24           | 18.25           | 22.65           | 22.60           | 24.17          | 25.89          |
| 1100               | 16.70  | 17.37           | 17.41           | 21.38           | 21.40           | 22.86          | 24.39          |
| 1200               | 15.84  | 16.47           | 16.51           | 20.07           | 20.10           | 21.35          | 22.65          |
| 1300               | 15.18  | 15.75           | 15.74           | 18.94           | 18.88           | 19.87          | 20.89          |
| 1400               | 14.84  | 15.30           | 15.22           | 18.14           | 17.95           | 18.70          | 19.51          |
| 1500               | 14.92  | 15.26           | 15.10           | 17.82           | 17.51           | 18.01          | 18.66          |
| 1600               | 15.24  | 15.43           | 15.19           | 17.65           | 17.27           | 17.51          | 17.95          |
| 1700               | 15.77  | 15.77           | 15.46           | 17.54           | 17.15           | 17.11          | 17.32          |
| 1800               | 16.25  | 16.08           | 15.74           | 17.35           | 17.07           | 16.84          | 16.82          |
| 1900               | 16.59  | 16.29           | 16.03           | 17.14           | 17.08           | 16.69          | 16.48          |
| 2000               | 16.86  | 16.55           | 16.40           | 17.03           | 17.27           | 16.77          | 16.39          |
| 2100               | 17.24  | 16.91           | 16.92           | 17.07           | 17.58           | 16.99          | 16.42          |
| 2200               | 17.84  | 17.55           | 17.70           | 17.59           | 18.33           | 17.63          | 16.92          |
| 2300               | 20.03  | 19.75           | 20.05           | 19.51           | 20.49           | 19.42          | 18.35          |
| 2400               | 24.39  | 24.34           | 24.98           | 22.68           | 23.55           | 21.59          | 19.99          |
| 2500               | 32.09  | 38.04           | 43.16           | 24.02           | 23.14           | 21.28          | 19.84          |
| 2600               | 25.65  | 29.00           | 28.63           | 22.51           | 20.77           | 19.66          | 18.76          |
| 2700               | 19.89  | 21.73           | 21.91           | 20.53           | 18.85           | 18.27          | 17.75          |
| 2800               | 16.10  | 17.58           | 18.01           | 18.56           | 17.43           | 17.29          | 17.07          |
| 2900               | 13.49  | 14.81           | 15.36           | 16.87           | 16.37           | 16.71          | 16.76          |
| 3000               | 11.56  | 12.77           | 13.37           | 15.44           | 15.55           | 16.41          | 16.78          |



# Digital Step Attenuator

# DAT-3175A-PP+

## Typical Performance Data

TEST CONDITIONS: INPUT POWER=-10dBm, Vdd=+3V, TEMPERATURE=+105degC

| FREQUENCY<br>(MHz) | OUTPUT RETURN LOSS AT TTL CONTROL STATE<br>(dB) |                 |                 |                 |                 |                |                |
|--------------------|---|-----------------|-----------------|-----------------|-----------------|----------------|----------------|
|                    | 0000<br>0 dB                                    | 00001<br>1.0 dB | 00010<br>2.0 dB | 00100<br>4.0 dB | 01000<br>8.0 dB | 10000<br>16 dB | 11111<br>31 dB |
| 10                 | 17.70   | 18.11           | 18.39           | 18.21           | 23.12           | 24.97          | 26.47          |
| 50                 | 17.57   | 17.99           | 18.25           | 18.11           | 22.84           | 24.63          | 26.28          |
| 100                | 17.75   | 18.19           | 18.51           | 18.41           | 23.43           | 25.41          | 27.18          |
| 150                | 17.56   | 18.03           | 18.36           | 18.29           | 23.28           | 25.27          | 26.97          |
| 200                | 17.46   | 17.96           | 18.32           | 18.27           | 23.24           | 25.27          | 27.03          |
| 250                | 17.05   | 17.52           | 17.87           | 17.82           | 22.43           | 24.27          | 25.83          |
| 300                | 16.80   | 17.25           | 17.59           | 17.52           | 21.89           | 23.59          | 25.03          |
| 350                | 16.51   | 16.93           | 17.23           | 17.13           | 21.20           | 22.71          | 23.99          |
| 400                | 16.42   | 16.81           | 17.09           | 16.95           | 20.90           | 22.30          | 23.50          |
| 450                | 16.43   | 16.79           | 17.03           | 16.84           | 20.63           | 21.92          | 23.04          |
| 500                | 16.54   | 16.87           | 17.09           | 16.89           | 20.65           | 21.89          | 22.98          |
| 550                | 16.74   | 17.04           | 17.24           | 17.00           | 20.74           | 21.92          | 22.95          |
| 600                | 16.94   | 17.24           | 17.43           | 17.16           | 20.99           | 22.15          | 23.21          |
| 700                | 17.42   | 17.72           | 17.91           | 17.60           | 21.67           | 22.83          | 23.91          |
| 800                | 17.86   | 18.20           | 18.41           | 18.05           | 22.43           | 23.70          | 24.84          |
| 900                | 18.20   | 18.60           | 18.83           | 18.41           | 23.19           | 24.61          | 25.87          |
| 1000               | 18.24   | 18.67           | 18.95           | 18.41           | 23.41           | 25.04          | 26.60          |
| 1100               | 17.94   | 18.38           | 18.66           | 18.04           | 22.93           | 24.73          | 26.48          |
| 1200               | 17.52   | 17.93           | 18.19           | 17.48           | 21.99           | 23.68          | 25.37          |
| 1300               | 17.15   | 17.46           | 17.64           | 16.83           | 20.87           | 22.21          | 23.60          |
| 1400               | 16.86   | 17.03           | 17.07           | 16.20           | 19.75           | 20.71          | 21.79          |
| 1500               | 16.63   | 16.61           | 16.55           | 15.67           | 18.74           | 19.41          | 20.23          |
| 1600               | 16.14   | 16.03           | 15.92           | 15.13           | 17.82           | 18.30          | 18.93          |
| 1700               | 15.91   | 15.76           | 15.65           | 14.99           | 17.49           | 17.86          | 18.36          |
| 1800               | 15.82   | 15.69           | 15.61           | 15.17           | 17.55           | 17.80          | 18.15          |
| 1900               | 15.99   | 15.90           | 15.86           | 15.66           | 17.95           | 18.05          | 18.21          |
| 2000               | 16.44   | 16.40           | 16.41           | 16.58           | 18.68           | 18.58          | 18.49          |
| 2100               | 17.04   | 17.07           | 17.14           | 17.82           | 19.57           | 19.18          | 18.76          |
| 2200               | 18.01   | 18.10           | 18.25           | 19.62           | 20.70           | 19.94          | 19.18          |
| 2300               | 19.39   | 19.61           | 19.86           | 22.23           | 22.15           | 20.81          | 19.65          |
| 2400               | 21.84   | 22.28           | 22.66           | 27.02           | 23.79           | 21.57          | 20.02          |
| 2500               | 25.17   | 26.54           | 27.61           | 35.50           | 24.34           | 21.59          | 19.97          |
| 2600               | 25.74   | 29.31           | 34.81           | 27.36           | 23.42           | 21.00          | 19.57          |
| 2700               | 20.68   | 22.75           | 24.90           | 20.96           | 21.25           | 19.83          | 18.85          |
| 2800               | 16.41   | 17.84           | 19.23           | 17.25           | 19.11           | 18.67          | 18.13          |
| 2900               | 13.41   | 14.57           | 15.72           | 14.70           | 17.40           | 17.84          | 17.75          |
| 3000               | 11.39   | 12.42           | 13.43           | 12.95           | 16.19           | 17.40          | 17.80          |

# Digital Step Attenuator

## Typical Performance Curves

# DAT-3175A-PP+

Thru Loss

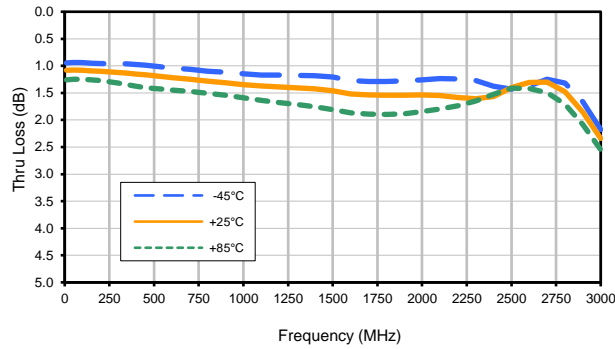

Step Attenuation (1dB)

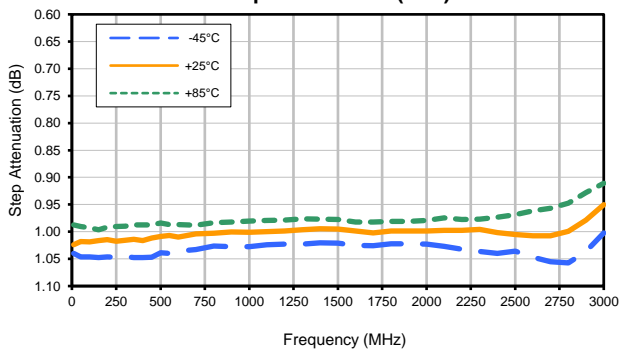

Step Attenuation (2dB)

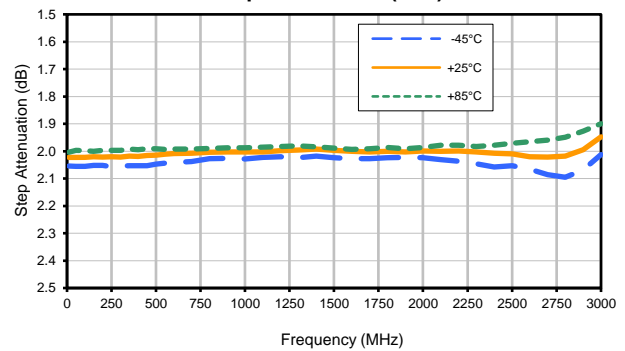

Step Attenuation (4dB)

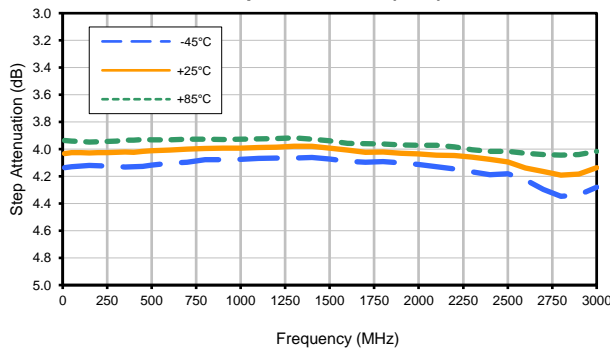

Step Attenuation (8dB)

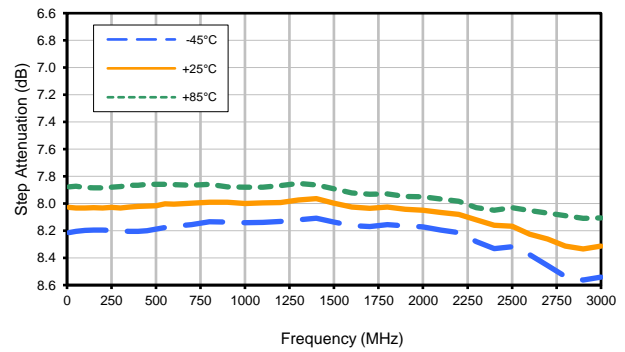

Step Attenuation (16dB)

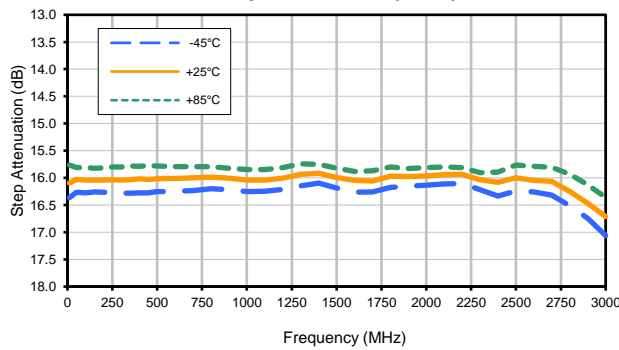

Step Attenuation (31dB)

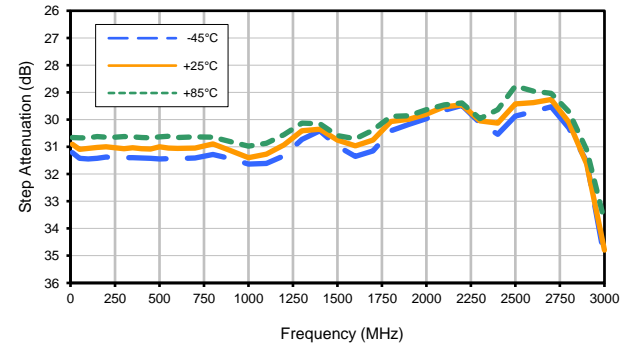

# Digital Step Attenuator

## Typical Performance Curves

# DAT-3175A-PP+

Input Return Loss (0dB)

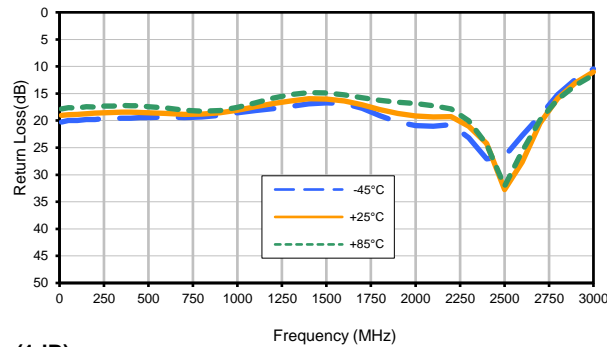

Input Return Loss (1dB)

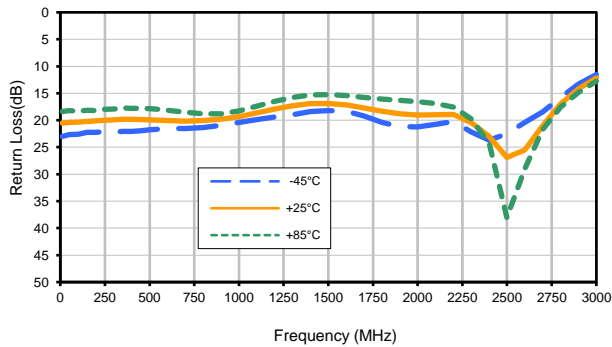

Input Return Loss (2dB)

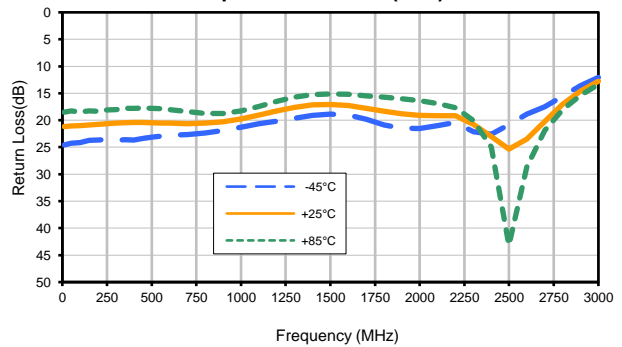

Input Return Loss (4dB)

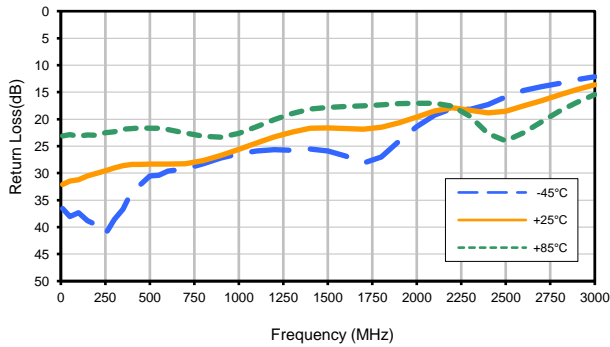

Input Return Loss (8dB)

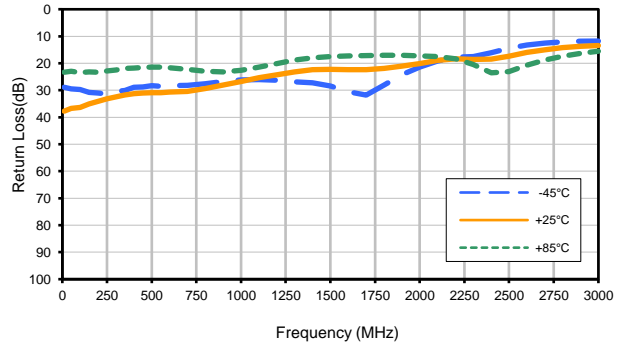

Input Return Loss (16dB)

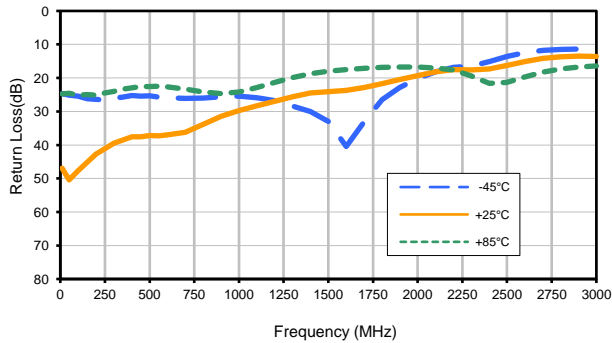

Input Return Loss (31dB)

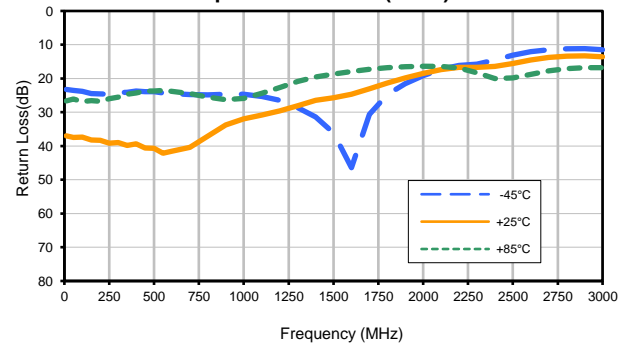

# Digital Step Attenuator

## Typical Performance Curves

# DAT-3175A-PP+

Output Return Loss (0dB)

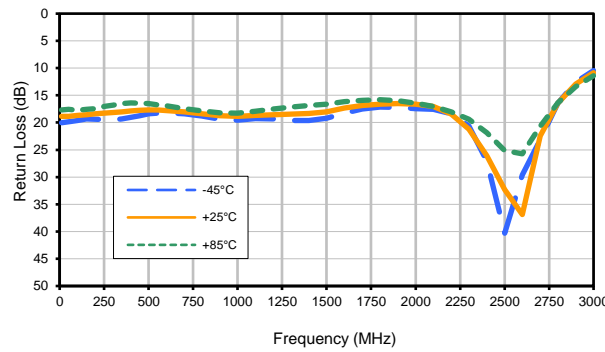

Output Return Loss (1dB)

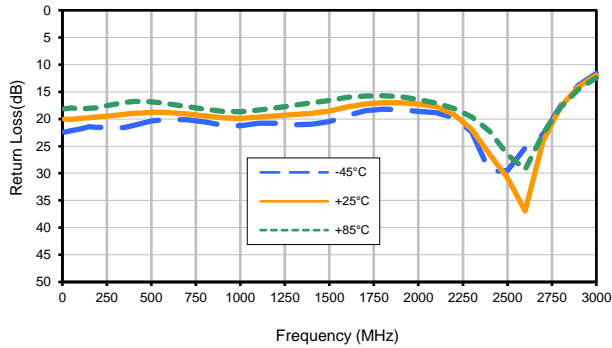

Output Return Loss (2dB)

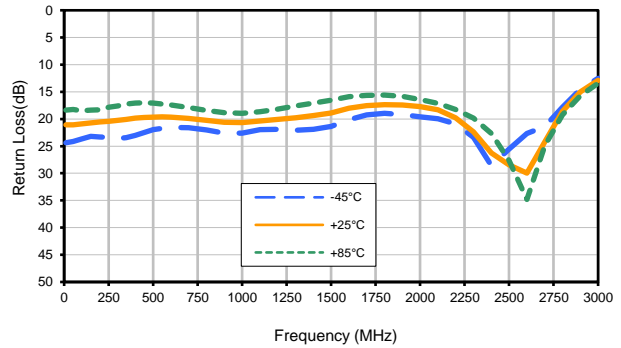

Output Return Loss (4dB)

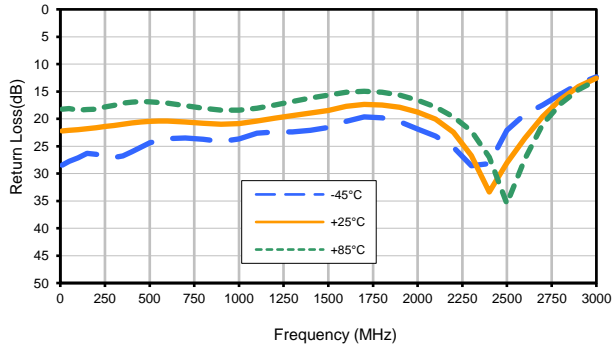

Output Return Loss(8dB)

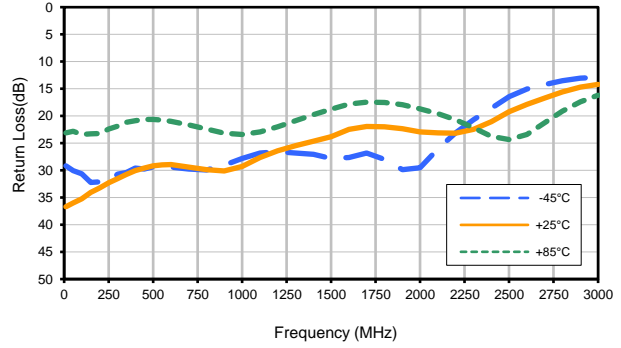

Output Return Loss(16dB)

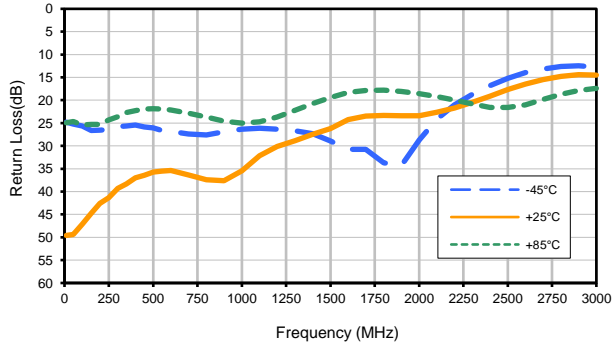

Output Return Loss (31dB)

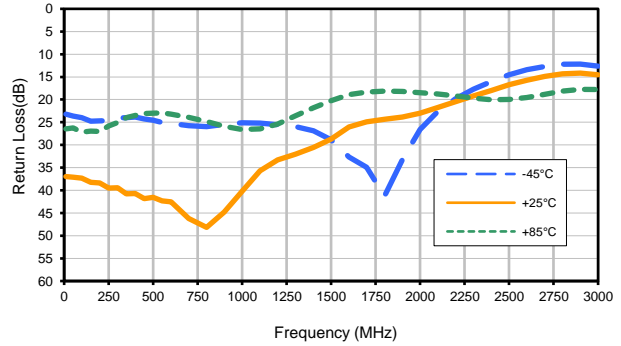

### Outline Dimensions

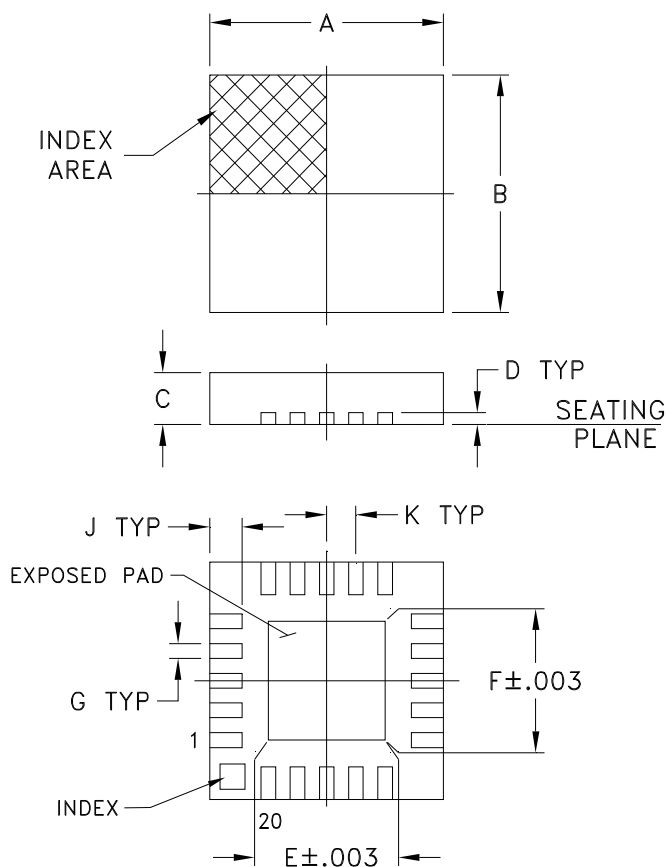

### PCB Land Pattern

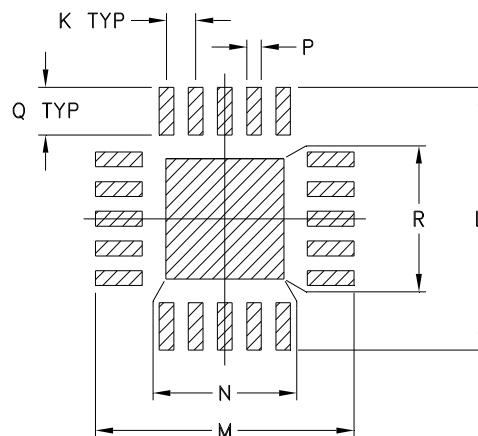

Suggested Layout,  
Tolerance to be within  $\pm .002$

| CASE #  | A              | B              | C              | D              | E              | F              | G              | H        | J              | K              |
|---------|----------------|----------------|----------------|----------------|----------------|----------------|----------------|----------|----------------|----------------|
| DG983-2 | .157<br>(4.00) | .157<br>(4.00) | .033<br>(0.85) | .008<br>(0.20) | .085<br>(2.15) | .085<br>(2.15) | .009<br>(0.23) | --<br>-- | .022<br>(0.55) | .020<br>(0.50) |

| CASE #  | L              | M              | N              | P              | Q              | R              | WT. GRAM |
|---------|----------------|----------------|----------------|----------------|----------------|----------------|----------|
| DG983-2 | .177<br>(4.50) | .177<br>(4.50) | .081<br>(2.06) | .010<br>(0.25) | .032<br>(0.81) | .081<br>(2.06) | .04      |

Dimensions are in inches (mm). Tolerances: 2 Pl.  $\pm .01$ ; 3 Pl.  $\pm .005$

#### Notes:

1. Case material: Plastic.
2. Termination finish:

For RoHS Case Styles: 0.2  $\mu$ inches of Gold (Au) over 0.1  $\mu$ inches of Palladium (Pd) over 10  $\mu$ inches of Nickel (Ni). All models, (+) suffix.

For RoHS-5 Case Styles: Tin-Lead plate. All models, no (+) suffix.



# Tape & Reel Packaging TR-F87

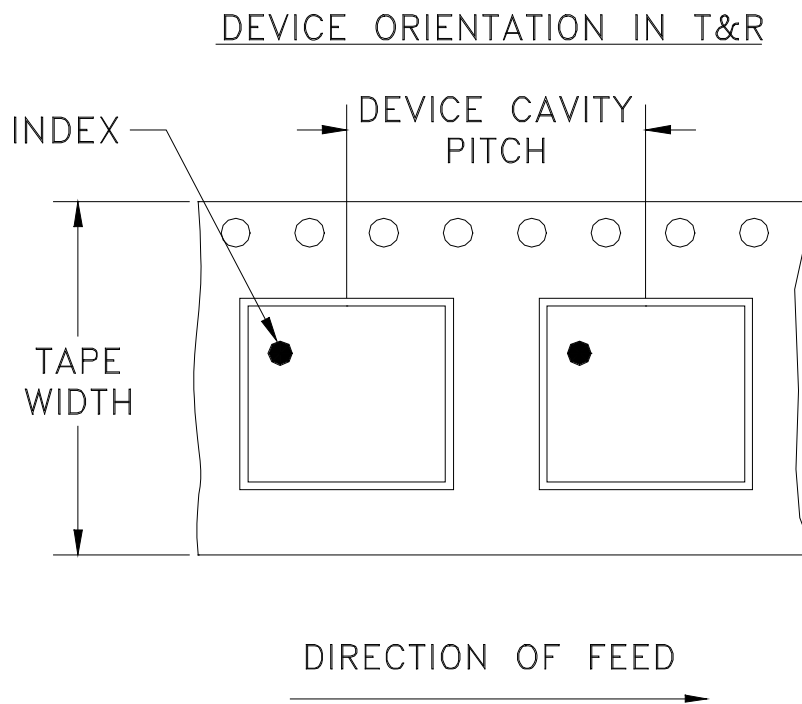

| Tape Width, mm | Device Cavity Pitch, mm | Reel Size, inches | Devices per Reel                    |      |
|----------------|-------------------------|-------------------|-------------------------------------|------|
| 12             | 8                       | 7                 | Small quantity standards (see note) | 20   |
|                |                         |                   |                                     | 50   |
|                |                         |                   |                                     | 100  |
|                |                         |                   |                                     | 200  |
|                |                         |                   |                                     | 500  |
|                |                         | 1000              |                                     |      |
|                |                         | 13                | Standard                            | 3000 |

**Note : Please Consult individual model data sheet to determine device per reel availability**

Mini-Circuits carrier tape materials provide protection from ESD (Electro-Static Discharge) during handling and transportation. Tapes are static dissipative and comply with industry standards EIA-481/EIA-541.

Go to: [www.minicircuits.com/pages/pdfs/tape.pdf](http://www.minicircuits.com/pages/pdfs/tape.pdf)



INTERNET <http://www.minicircuits.com>

P.O. Box 350166, Brooklyn, New York 11235-0003 (718) 934-4500 Fax (718) 332-4661

Distribution Centers NORTH AMERICA 800-654-7949 • 417-335-5935 • Fax 417-335-5945 • EUROPE 44-1252-832600 • Fax 44-1252-837010

Mini-Circuits ISO 9001 & ISO 14001 Certified

THIRD ANGLE PROJECTION

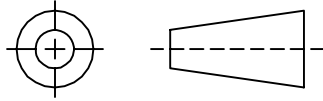

REVISIONS

| REV | ECN No. | DESCRIPTION                                   | DATE  | DR | AUTH |
|-----|---------|---|-------|----|------|
| OR  | M97254  | NEW RELEASE (FROM RAVON)                      | 03/05 | DK | HH   |
| A   | M102713 | MODIFIED HATCH, NOTES & ADDED "...WITH SMOBC" | 01/06 | GT | IL   |
| B   | M103510 | ADD R7 & CHANGE LOCATION DESIGNATORS          | 07/09 | EM | KN   |
| B   | R63339  | ADD R7 & CHANGE LOCATION DESIGNATORS          | 07/09 | EM | KN   |

SUGGESTED MOUNTING CONFIGURATION

FOR DG983-1 CASE STYLE, qs PIN CONNECTIONS, 75 Ω.

KEEP-OUT ZONE,  
.025 X.025, AVOID  
TRACES IN THIS AREA  
TO PREVENT SHORT TO  
METAL INDEX ON BOTTOM  
SIDE OF COMPONENT

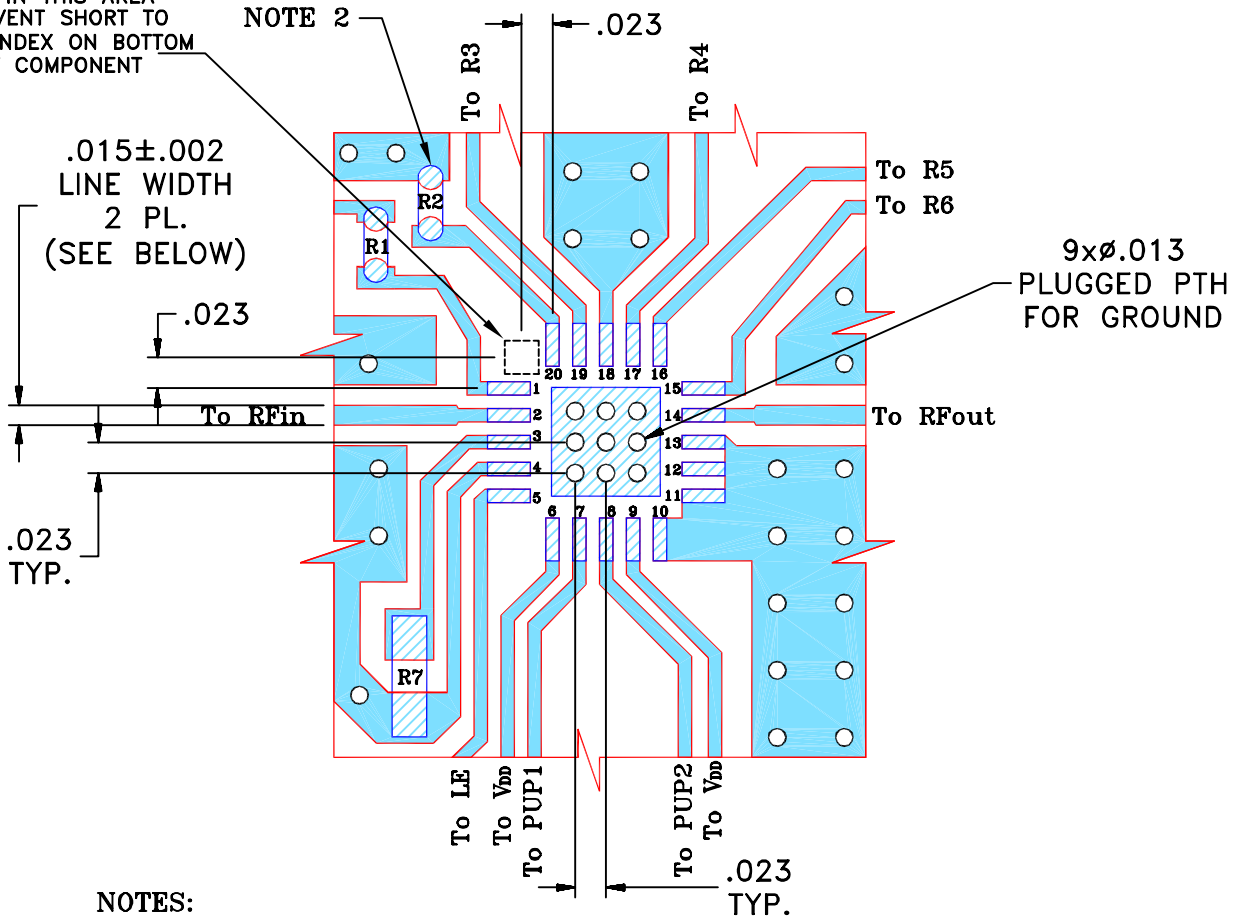

NOTES:

1. TRACE WIDTH IS SHOWN FOR FR4 WITH DIELECTRIC THICKNESS .025"±.002". COPPER: 1/2 OZ. EACH SIDE. FOR OTHER MATERIALS TRACE WIDTH MAY NEED TO BE MODIFIED.
2. 0603, 0402 SIZES CHIP FOOT PRINTS SHOWN FOR REFERENCE, VALUES OF RESISTORS WILL VARY BASED ON APPLICATION.
3. BOTTOM SIDE OF THE PCB IS CONTINUOUS GROUND PLANE.



DENOTES PCB COPPER LAYOUT WITH SMOBC (SOLDER MASK OVER BARE COPPER)



DENOTES COPPER LAND PATTERN FREE OF SOLDER MASK

UNLESS OTHERWISE SPECIFIED

INITIALS DATE

DIMENSIONS ARE IN INCHES

|          |            |           |
|----------|------------|-----------|
| DRAWN    | DK (RAVON) | 08 MAR 05 |
| CHECKED  | RZ (RAVON) | 08 MAR 05 |
| APPROVED | HH (RAVON) | 08 MAR 05 |

TOLERANCES ON:  
2 PL DECIMALS ±  
3 PL DECIMALS ± .005  
ANGLES ±  
FRACTIONS ±

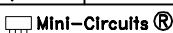

THIS DOCUMENT AND ITS CONTENTS ARE THE PROPERTY OF MINI-CIRCUITS. EXCEPT FOR USE EXPRESSLY GRANTED, IN WRITING, TO ITS VENDORS, VENDEE AND THE UNITED STATES GOVERNMENT, MINI-CIRCUITS RESERVES ALL PROPRIETARY DESIGN, USE, MANUFACTURING AND REPRODUCTION RIGHTS THERETO. THESE CONTENTS SHALL NOT BE USED, DUPLICATED OR DISCLOSED TO ANY OUTSIDE PARTY, IN WHOLE OR IN PART, WITHOUT WRITTEN PERMISSION OF MINI-CIRCUITS.



Mini-Circuits®

13 Neptune Avenue  
Brooklyn NY 11235

PL, qs, DG983-1  
TB-337 (75 Ω)

|                  |                     |                          |           |
|------------------|---------------------|--------------------------|-----------|
| SIZE<br>A        | CODE IDENT<br>15542 | DRAWING NO:<br>98-PL-193 | REV:<br>B |
| FILE:<br>98PL193 | SCALE:<br>7:1       | SHEET:<br>1 OF 1         |           |





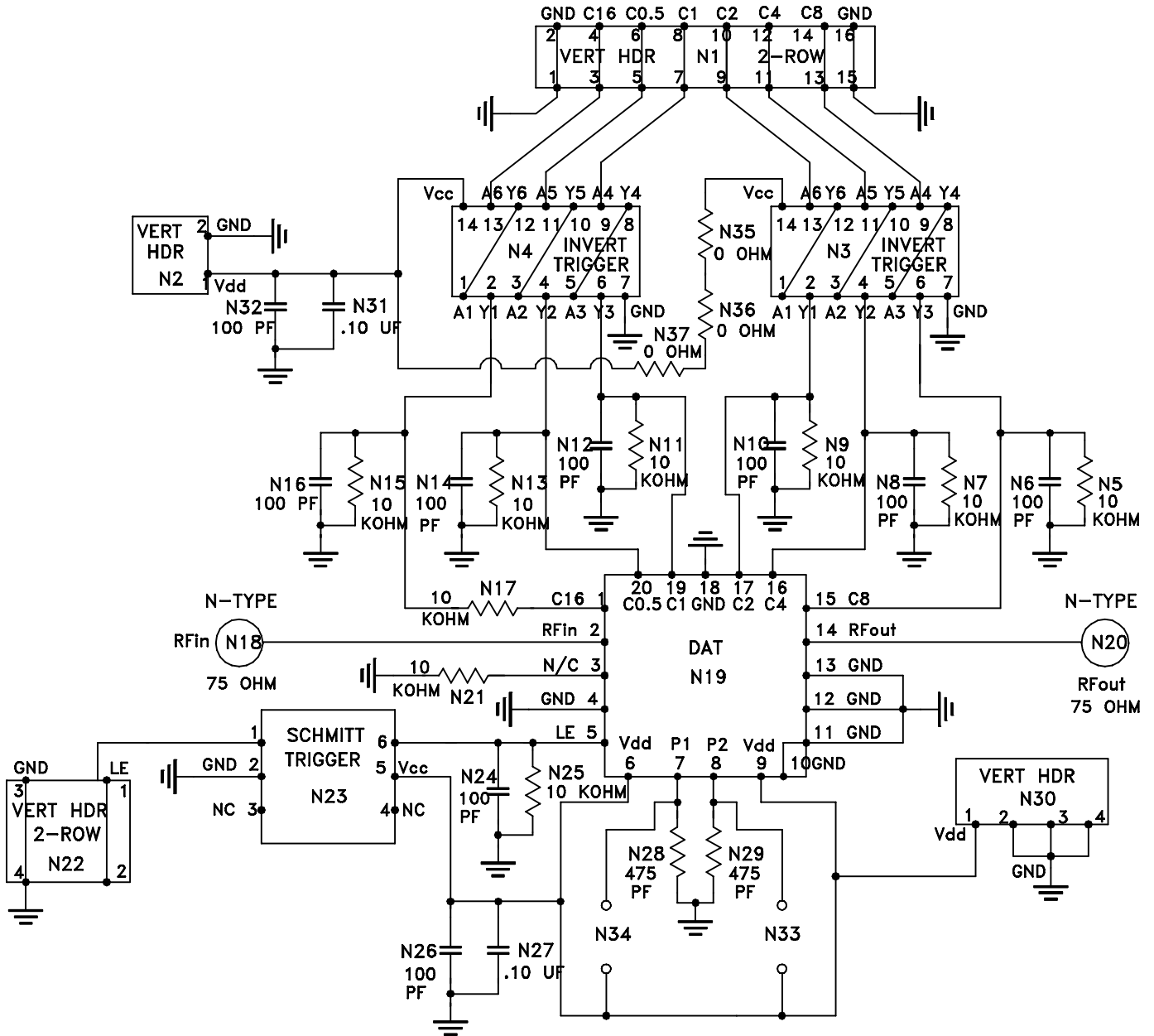

Schematic Diagram

All Mini-Circuits products are manufactured under exacting quality assurance and control standards, and are capable of meeting published specifications after being subjected to any or all of the following physical and environmental test.

| <b>Specification</b>           | <b>Test/Inspection Condition</b>                        | <b>Reference/Spec</b>                                 |
|--------------------------------|---|---|
| Operating Temperature          | -40° to 85° C or -40° to 105° C<br>Ambient Environment  | Refer to Individual Model Data Sheet                  |
| Storage Temperature            | -55° to 100° C or -65° to 150° C<br>Ambient Environment | Refer to Individual Model Data Sheet                  |
| Temperature Humidity Bias      | 85°C, 85% RH, 96 hours                                  | JESD22-A101B  |
| Thermal Shock                  | -55° to 100°C, 100 cycles                               | MIL-STD-202, Method 107, Condition A-3, except +100°C |
| Solder Reflow Heat             | Pb-Free Process: 260°C peak                             | J-STD-020, Table 4-1, 4-2 and 5-2; Figure 5-1         |
| Solderability                  | 10X magnification, 95% coverage                         | JESD22-B102, Method 1: Dip and Look Test              |
| Marking Resistance to Solvents | Laser marked, visual observation                        | Mini-Circuits D4-Q4T0-04                              |