

Surface Mount Directional Coupler

D171A+

50Ω 17 dB 2300 to 2600 MHz



CASE STYLE: CA531

The Big Deal

- Excellent Power Handling, 4W
- Good Directivity, 14 dB typ.
- Small Size, 3.1 x 3.0 x 1.6mm

Product Overview

Mini-Circuits D171A+ is a MMIC directional coupler designed for applications from 2300 to 2600 MHz. This model provides excellent power handling up to 4W in a tiny device package (3.1 x 3.0 x 1.6 mm). A built-in 50Ω termination on the isolated port simplifies circuit design and reduces component count. Manufactured using Silicon IPD technology, this model provides a high level of ESD protection and excellent reliability.

Key Features

Feature	Advantages
Low insertion loss; 0.4 dB including coupling loss	Can be used for sampling power amplifier output with minimal loss.
Excellent power handling; 4W (IN-OUT)	Ideal for sampling transmitter output power.
With good directivity, 14 dB typ.	Good directivity minimizes coupling of reverse power and enables accurate sampling of the thru-signal.
High operating temperature -40 to 105°C	Operation up to 105°C allows the Coupler to be used near power amplifiers with minimal change in performance.
Excellent ESD Class 1B (500 to <1000V)-HBM Class M3 (200 to <400V)-MM	Rugged ESD design prevents ESD related failures.

Surface Mount Directional Coupler

D171A+

50Ω 17 dB 2300 to 2600 MHz

Features

- low mainline loss, 0.4 dB typ.
- excellent VSWR, 1.2:1 typ. at input / output
- excellent repeatability
- miniature low profile package
- aqueous washable

Applications

- WLAN
- WMAX
- Aeronautical



CASE STYLE: CA531

+RoHS Compliant

The +Suffix identifies RoHS Compliance. See our web site for RoHS Compliance methodologies and qualifications

Electrical Specifications at 25°C

Parameter	Condition (MHz)	Min.	Typ.	Max.	Unit
Frequency Range		2300		2600	MHz
Mainline Loss ¹	2300 - 2600	—	0.4	0.7	dB
Nominal Coupling	2300 - 2600	15.9	17.1	18.3	dB
Coupling Flatness(±)	2300 - 2600	—	0.5	—	dB
Directivity	2300 - 2600	9	14	—	dB
Return Loss (Input)	2300 - 2600	—	23	—	dB
Return Loss (Output)	2300 - 2600	—	23	—	dB
Return Loss (Coupling)	2300 - 2600	—	16	—	dB
Input Power ²	2300 - 2600	—	—	4.0	W
Power at Internal Termination ³	2300 - 2600	—	—	23	dBm

1. Mainline loss includes theoretical power loss at coupled port.

2. 4Watt CW when ground lead temperature to 85°C. Derate linearly to 3W at 105°C.

3. 23 dBm to 85°C. Derate linearly to +22dBm at 105°C.

Maximum Ratings⁴

Parameter	Ratings
Operating Temperature ⁵	-40°C to 105°C
Storage Temperature	-65°C to 150°C

4. Permanent damage may occur if any of these limits are exceeded.

5. Ground lead temperature

Pin Connections

Function	Pin Number
INPUT	4
OUTPUT	6
COUPLED	3
GROUND	1,2,5

Electrical Schematic

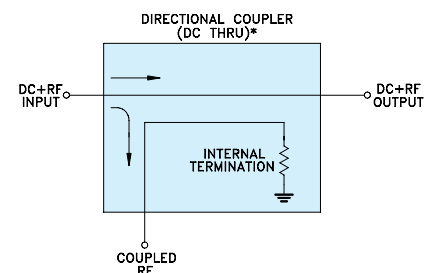

* ESD rating

Human body model (HBM): Class 1B(500 to <1000 V) in accordance with ANSI/ESD 5.1-2007

Machine model (MM): Class M3 (200 to <400 V) in accordance with ANSI/ESD SMT 5.2 1999

Outline Drawing

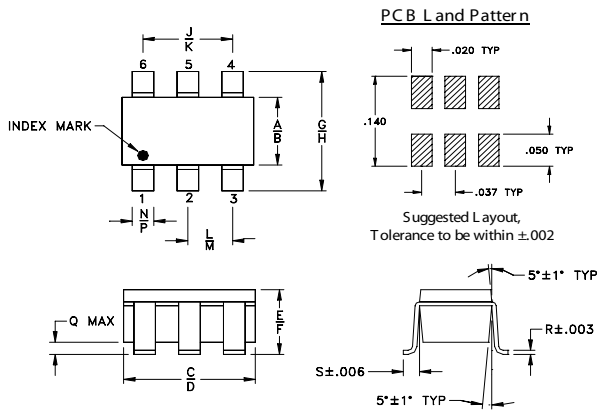

Outline Dimensions (inch)

A	B	C	D	E	F	G	H	J	
.052	.067	.106	.122	.035	.064	.087	.118	.067	
1.32	1.70	2.69	3.10	0.89	1.63	2.21	3.00	1.70	
K	L	M	N	P	Q	R	S	wt	
.083	.033	.042	.012	.020	.012	.006	.018	grams	
2.11	0.84	1.07	0.30	0.51	0.30	0.15	0.46	0.020	

PCB Land Pattern

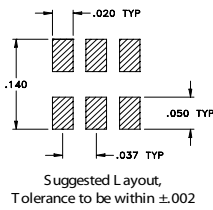

Demo Board MCL P/N: TB-396+ Suggested PCB Layout (PL-270)

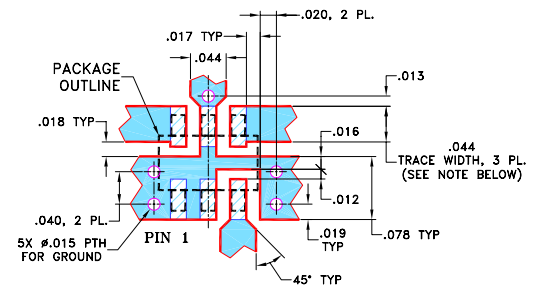

- NOTES: 1. TRACE WIDTH IS SHOWN FOR ROGERS RO4350B WITH DIELECTRIC THICKNESS 0.020" ± 0.0015". COPPER: 1/2 OZ. EACH SIDE. FOR OTHER MATERIALS TRACE WIDTH MAY NEED TO BE MODIFIED.
2. BOTTOM SIDE OF THE PCB IS CONTINUOUS GROUND PLANE.

- DENOTES PCB COPPER LAYOUT WITH SMOBC (SOLDER MASK OVER BARE COPPER)
- DENOTES COPPER LAND PATTERN FREE OF SOLDER MASK

Product Marking

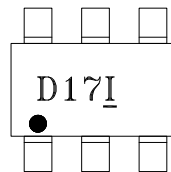

← Family marking

Typical Performance Data

Frequency (MHz)	Mainline Loss (dB) In-Out	Coupling (dB) In-Cpl	Directivity (dB)	Return Loss (dB)		
				In	Out	Cpl
2300	0.37	17.61	15.61	26.14	26.88	17.26
2325	0.38	17.53	15.53	26.00	26.75	17.17
2350	0.38	17.44	15.43	25.85	26.61	17.08
2400	0.39	17.28	15.23	25.53	26.28	16.89
2475	0.40	17.05	14.93	25.05	25.82	16.60
2450	0.39	17.12	15.03	25.20	25.97	16.68
2500	0.40	16.97	14.82	24.88	25.64	16.52
2550	0.41	16.83	14.61	24.55	25.33	16.33
2575	0.42	16.75	14.51	24.49	25.27	16.23
2600	0.42	16.68	14.41	24.32	25.09	16.13

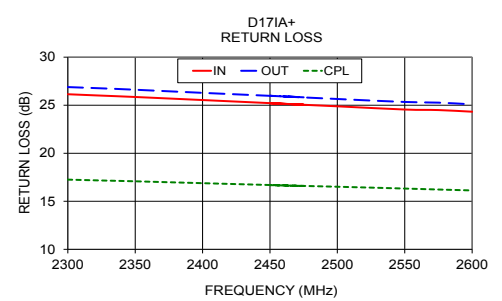
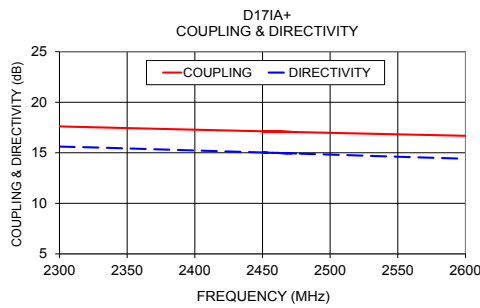
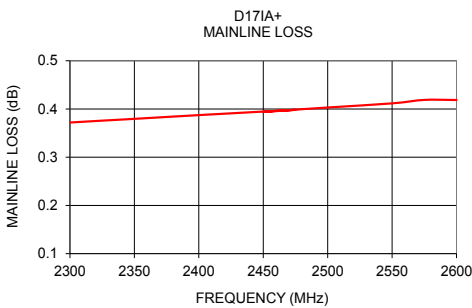

Additional Notes

- Performance and quality attributes and conditions not expressly stated in this specification document are intended to be excluded and do not form a part of this specification document.
- Electrical specifications and performance data contained in this specification document are based on Mini-Circuit's applicable established test performance criteria and measurement instructions.
- The parts covered by this specification document are subject to Mini-Circuits standard limited warranty and terms and conditions (collectively, "Standard Terms"); Purchasers of this part are entitled to the rights and benefits contained therein. For a full statement of the Standard Terms and the exclusive rights and remedies thereunder, please visit Mini-Circuits' website at www.minicircuits.com/MCLStore/terms.jsp

Directional Coupler

D171A+

Typical Performance Data

TEST CONDITIONS: INPUT POWER =0 dBm @Temperature = +25°C

FREQUENCY (MHz)	INSERTION LOSS (dB)	COUPLING LOSS (dB)	DIRECTIVITY (dB)	RETURN LOSS (dB)		
				In	Out	Cpl
2000	0.21	18.58	16.80	27.33	28.02	18.33
2025	0.21	18.49	16.69	27.25	27.94	18.19
2050	0.22	18.39	16.64	27.16	27.84	18.12
2075	0.22	18.30	16.51	26.99	27.63	18.06
2100	0.22	18.19	16.43	26.95	27.55	17.93
2125	0.22	18.10	16.33	26.82	27.46	17.88
2150	0.23	18.01	16.27	26.74	27.34	17.77
2175	0.23	17.92	16.15	26.54	27.15	17.64
2200	0.23	17.83	16.08	26.40	27.09	17.58
2225	0.23	17.74	16.01	26.32	27.00	17.46
2250	0.23	17.65	15.85	26.19	26.74	17.36
2275	0.24	17.56	15.80	25.98	26.68	17.30
2300	0.24	17.48	15.71	25.94	26.54	17.17
2325	0.24	17.39	15.60	25.75	26.40	17.09
2350	0.25	17.31	15.54	25.61	26.31	17.03
2375	0.25	17.23	15.40	25.43	26.06	16.91
2400	0.25	17.15	15.30	25.25	25.91	16.85
2425	0.25	17.06	15.22	25.14	25.81	16.75
2450	0.26	16.98	15.10	24.94	25.58	16.63
2475	0.26	16.91	15.02	24.76	25.46	16.58
2500	0.26	16.83	14.90	24.62	25.24	16.46
2525	0.26	16.76	14.79	24.40	25.08	16.36
2550	0.27	16.68	14.70	24.23	24.91	16.31
2575	0.27	16.61	14.59	24.17	24.82	16.18
2600	0.27	16.54	14.50	23.95	24.67	16.08
2625	0.27	16.46	14.42	23.80	24.47	16.01
2650	0.28	16.39	14.31	23.60	24.26	15.87
2675	0.28	16.33	14.18	23.39	24.10	15.76
2700	0.28	16.25	14.09	23.25	23.94	15.67
2725	0.29	16.18	13.98	23.03	23.69	15.53
2750	0.29	16.12	13.88	22.85	23.53	15.46
2775	0.29	16.05	13.74	22.66	23.37	15.36
2800	0.29	15.98	13.64	22.49	23.16	15.24

Directional Coupler

D171A+

Typical Performance Data

TEST CONDITIONS: INPUT POWER =0 dBm @Temperature = -45 °C

FREQUENCY (MHz)	INSERTION LOSS (dB)	COUPLING LOSS (dB)	DIRECTIVITY (dB)	RETURN LOSS (dB)		
				In	Out	Cpl
2000	0.12	18.52	16.24	26.49	27.06	16.56
2025	0.12	18.42	16.14	26.52	27.12	16.46
2050	0.12	18.32	16.07	26.56	27.15	16.41
2075	0.12	18.22	15.96	26.49	27.05	16.35
2100	0.12	18.12	15.86	26.58	27.10	16.25
2125	0.13	18.02	15.79	26.53	27.13	16.21
2150	0.13	17.93	15.68	26.53	27.09	16.12
2175	0.13	17.84	15.54	26.40	26.98	16.03
2200	0.13	17.74	15.49	26.28	26.97	15.99
2225	0.13	17.66	15.40	26.23	26.91	15.88
2250	0.13	17.56	15.24	26.10	26.64	15.80
2275	0.13	17.48	15.21	25.86	26.56	15.76
2300	0.14	17.39	15.08	25.81	26.42	15.65
2325	0.14	17.30	14.98	25.58	26.23	15.61
2350	0.14	17.22	14.92	25.42	26.13	15.56
2375	0.14	17.14	14.76	25.23	25.86	15.47
2400	0.14	17.05	14.64	25.02	25.69	15.44
2425	0.14	16.97	14.57	24.92	25.59	15.36
2450	0.15	16.89	14.44	24.74	25.38	15.28
2475	0.15	16.81	14.35	24.56	25.27	15.23
2500	0.15	16.73	14.25	24.46	25.09	15.14
2525	0.15	16.66	14.15	24.29	24.96	15.06
2550	0.16	16.59	14.05	24.13	24.81	15.02
2575	0.16	16.51	13.96	24.13	24.81	14.91
2600	0.16	16.43	13.87	23.95	24.68	14.83
2625	0.16	16.35	13.78	23.82	24.49	14.76
2650	0.16	16.28	13.67	23.65	24.30	14.64
2675	0.16	16.21	13.60	23.44	24.18	14.57
2700	0.16	16.14	13.49	23.32	24.02	14.48
2725	0.17	16.07	13.37	23.11	23.77	14.37
2750	0.17	16.01	13.27	22.92	23.62	14.31
2775	0.17	15.94	13.16	22.71	23.46	14.23
2800	0.18	15.87	13.04	22.54	23.21	14.13

Directional Coupler

D171A+

Typical Performance Data

TEST CONDITIONS: INPUT POWER =0 dBm @Temperature = +85 °C

FREQUENCY (MHz)	INSERTION LOSS (dB)	COUPLING LOSS (dB)	DIRECTIVITY (dB)	RETURN LOSS (dB)		
				In	Out	Cpl
2000	0.27	18.61	16.93	26.88	27.53	19.57
2025	0.27	18.52	16.85	26.77	27.42	19.41
2050	0.27	18.42	16.76	26.65	27.30	19.31
2075	0.28	18.33	16.70	26.46	27.07	19.22
2100	0.28	18.23	16.63	26.40	26.96	19.05
2125	0.28	18.14	16.56	26.25	26.86	18.97
2150	0.28	18.05	16.46	26.15	26.72	18.84
2175	0.29	17.96	16.35	25.94	26.50	18.68
2200	0.29	17.86	16.28	25.80	26.44	18.61
2225	0.29	17.78	16.25	25.71	26.35	18.46
2250	0.29	17.69	16.11	25.57	26.06	18.34
2275	0.30	17.60	16.04	25.36	26.01	18.26
2300	0.30	17.53	15.99	25.31	25.86	18.10
2325	0.30	17.44	15.88	25.12	25.69	18.00
2350	0.31	17.36	15.83	24.98	25.61	17.91
2375	0.31	17.27	15.68	24.81	25.36	17.75
2400	0.31	17.19	15.57	24.64	25.20	17.68
2425	0.32	17.12	15.51	24.52	25.08	17.58
2450	0.32	17.04	15.40	24.32	24.87	17.44
2475	0.33	16.96	15.30	24.14	24.73	17.38
2500	0.33	16.89	15.21	24.00	24.52	17.25
2525	0.33	16.81	15.11	23.79	24.36	17.12
2550	0.34	16.74	15.01	23.62	24.19	17.06
2575	0.34	16.66	14.92	23.53	24.07	16.91
2600	0.34	16.59	14.82	23.33	23.92	16.79
2625	0.34	16.52	14.73	23.19	23.73	16.71
2650	0.35	16.45	14.61	22.98	23.52	16.55
2675	0.35	16.38	14.51	22.78	23.38	16.45
2700	0.35	16.31	14.41	22.64	23.22	16.34
2725	0.36	16.25	14.27	22.44	22.97	16.19
2750	0.36	16.18	14.21	22.27	22.83	16.11
2775	0.36	16.11	14.06	22.07	22.67	16.01
2800	0.37	16.05	13.95	21.93	22.47	15.87

Directional Coupler

D171A+

Typical Performance Data

TEST CONDITIONS: INPUT POWER =0 dBm @Temperature = +105 °C

FREQUENCY (MHz)	INSERTION LOSS (dB)	COUPLING LOSS (dB)	DIRECTIVITY (dB)	RETURN LOSS (dB)		
				In	Out	Cpl
2000	0.28	18.62	16.95	26.27	26.88	20.01
2025	0.29	18.53	16.89	26.14	26.77	19.83
2050	0.29	18.43	16.79	26.00	26.61	19.73
2075	0.29	18.34	16.71	25.79	26.37	19.62
2100	0.30	18.24	16.61	25.70	26.24	19.43
2125	0.30	18.16	16.51	25.54	26.12	19.33
2150	0.30	18.06	16.46	25.42	25.97	19.17
2175	0.30	17.97	16.32	25.22	25.76	18.99
2200	0.31	17.88	16.27	25.07	25.69	18.91
2225	0.31	17.79	16.21	24.98	25.60	18.75
2250	0.31	17.70	16.06	24.85	25.33	18.62
2275	0.32	17.62	16.01	24.66	25.28	18.54
2300	0.32	17.54	15.93	24.62	25.14	18.37
2325	0.32	17.45	15.82	24.45	25.00	18.26
2350	0.33	17.37	15.75	24.33	24.93	18.18
2375	0.33	17.29	15.62	24.19	24.72	18.01
2400	0.33	17.21	15.53	24.04	24.57	17.93
2425	0.34	17.13	15.46	23.94	24.48	17.81
2450	0.34	17.05	15.35	23.77	24.30	17.67
2475	0.35	16.98	15.24	23.63	24.18	17.60
2500	0.35	16.90	15.17	23.52	24.01	17.46
2525	0.35	16.83	15.07	23.32	23.87	17.33
2550	0.36	16.76	14.97	23.18	23.73	17.26
2575	0.36	16.68	14.90	23.11	23.62	17.11
2600	0.36	16.61	14.79	22.93	23.48	16.98
2625	0.37	16.54	14.71	22.82	23.33	16.90
2650	0.37	16.47	14.61	22.63	23.14	16.74
2675	0.37	16.40	14.49	22.46	23.02	16.63
2700	0.38	16.33	14.41	22.34	22.88	16.52
2725	0.38	16.27	14.30	22.16	22.66	16.36
2750	0.38	16.20	14.22	22.02	22.55	16.27
2775	0.39	16.14	14.07	21.85	22.40	16.17
2800	0.39	16.07	13.97	21.73	22.23	16.04

Directional Coupler

D171A+

Typical Performance Data

TEST CONDITIONS: INPUT POWER =0 dBm @Temperature = +125 °C

FREQUENCY (MHz)	INSERTION LOSS (dB)	COUPLING LOSS (dB)	DIRECTIVITY (dB)	RETURN LOSS (dB)		
				In	Out	Cpl
2000	0.30	18.64	16.83	25.04	25.57	20.26
2025	0.30	18.54	16.74	24.92	25.45	20.09
2050	0.31	18.45	16.66	24.76	25.29	19.98
2075	0.31	18.35	16.56	24.57	25.07	19.85
2100	0.31	18.26	16.48	24.48	24.93	19.61
2125	0.31	18.17	16.37	24.32	24.83	19.49
2150	0.32	18.07	16.31	24.22	24.70	19.31
2175	0.32	17.99	16.16	24.05	24.53	19.12
2200	0.33	17.90	16.11	23.94	24.48	19.03
2225	0.33	17.81	16.01	23.88	24.42	18.88
2250	0.33	17.72	15.92	23.79	24.21	18.76
2275	0.34	17.64	15.84	23.67	24.22	18.70
2300	0.34	17.55	15.75	23.66	24.13	18.53
2325	0.34	17.47	15.68	23.55	24.05	18.43
2350	0.35	17.39	15.62	23.49	24.04	18.33
2375	0.35	17.30	15.52	23.40	23.87	18.15
2400	0.35	17.23	15.40	23.31	23.79	18.04
2425	0.35	17.14	15.35	23.26	23.75	17.91
2450	0.36	17.07	15.26	23.14	23.62	17.75
2475	0.36	17.00	15.16	23.04	23.55	17.67
2500	0.36	16.92	15.07	22.96	23.41	17.53
2525	0.37	16.85	14.99	22.81	23.30	17.40
2550	0.38	16.77	14.91	22.70	23.19	17.35
2575	0.38	16.70	14.83	22.65	23.12	17.21
2600	0.38	16.63	14.74	22.50	23.03	17.10
2625	0.38	16.55	14.64	22.41	22.90	17.02
2650	0.39	16.48	14.56	22.26	22.75	16.87
2675	0.39	16.42	14.44	22.13	22.66	16.74
2700	0.39	16.34	14.39	22.05	22.55	16.63
2725	0.40	16.28	14.26	21.92	22.39	16.46
2750	0.40	16.21	14.18	21.81	22.31	16.38
2775	0.40	16.15	14.05	21.70	22.23	16.27
2800	0.41	16.08	13.97	21.63	22.11	16.14

Directional Coupler

D171A+

Typical Performance Curves

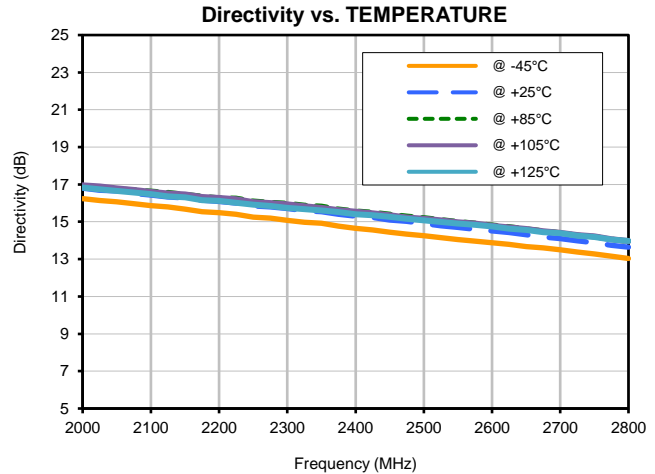
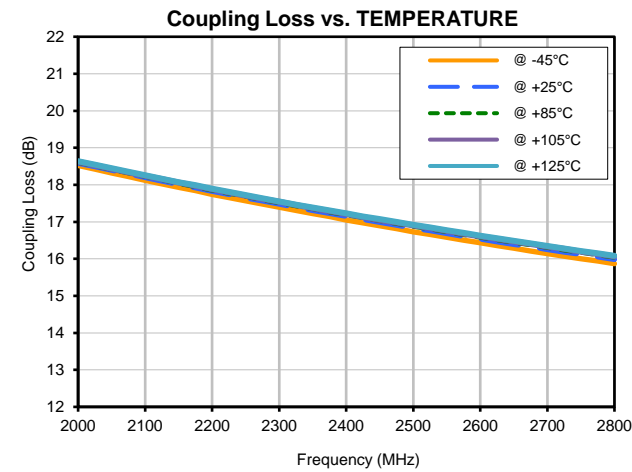
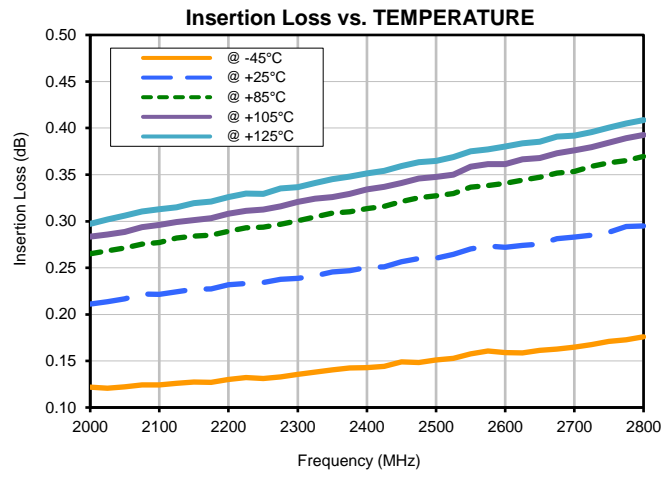
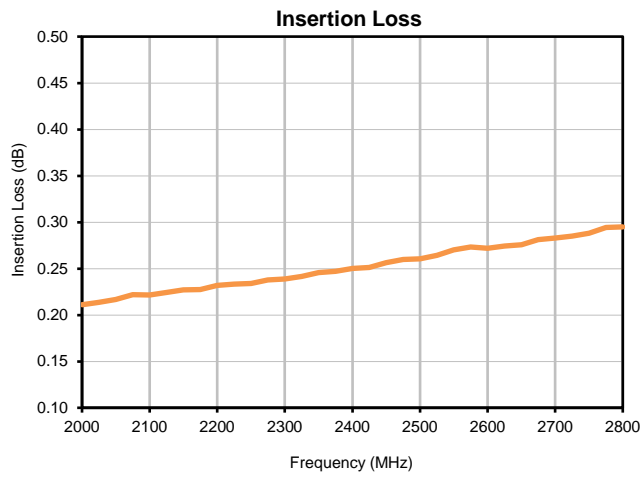

Directional Coupler

D171A+

Typical Performance Curves

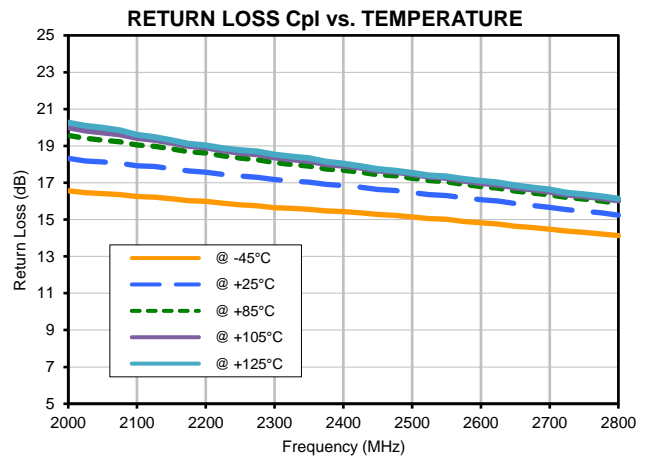
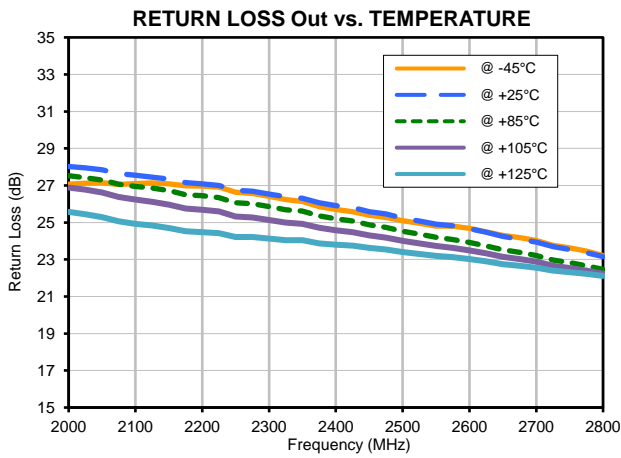
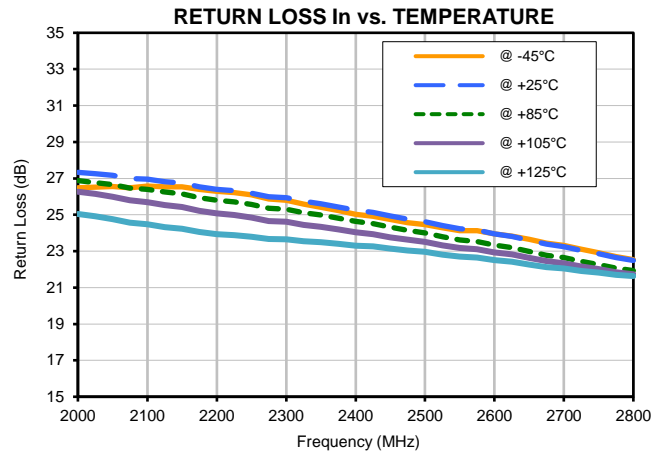
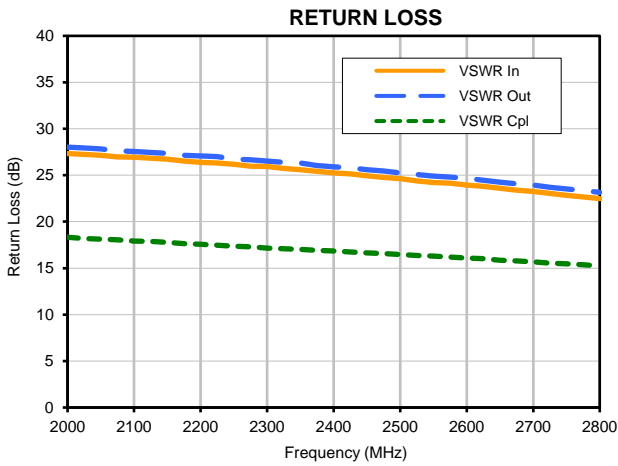

P.O. Box 350166, Brooklyn, New York 11235-0003 (718) 934-4500 • Fax (718) 332-4661 For detailed performance specs & shopping online see Mini-Circuits web site
 The Design Engineers Search Engine Provides ACTUAL Data Instantly From MINI-CIRCUITS At: www.minicircuits.com



IF/RF MICROWAVE COMPONENTS

REV. OR
 D171A+
 11/16/2015
 Page 2 of 2

Outline Dimensions

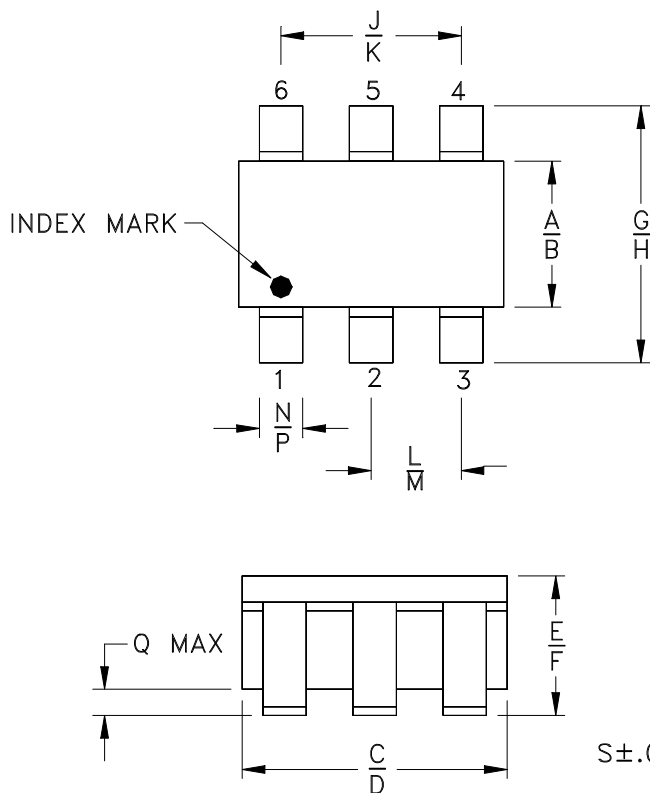

PCB Land Pattern

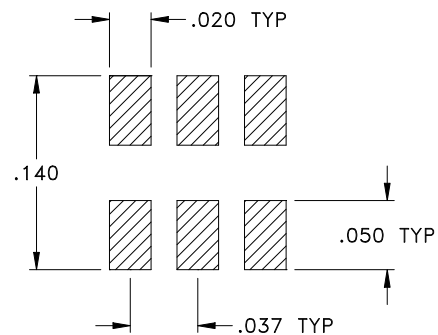

Suggested Layout,
Tolerance to be within $\pm .002$

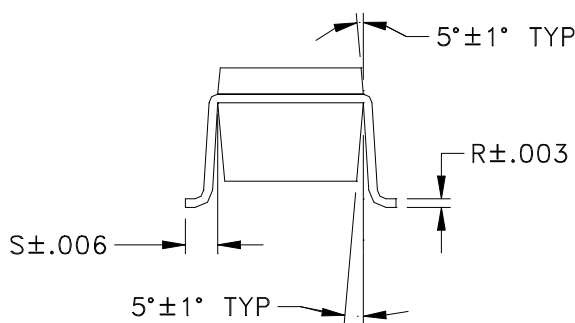

CASE #	A	B	C	D	E	F	G	H	J	K
CA531	.052 (1.32)	.067 (1.70)	.106 (2.69)	.122 (3.10)	.035 (0.89)	.064 (1.63)	.087 (2.21)	.118 (3.00)	.067 (1.70)	.083 (2.11)

CASE #	L	M	N	P	Q	R	S	WT. GRAM
CA531	.033 (0.84)	.042 (1.07)	.012 (0.30)	.020 (0.51)	.012 (0.30)	.006 (0.15)	.018 (0.46)	.020

Dimensions are in inches (mm). Tolerances: 2Pl. $\pm .01$; 3Pl. $\pm .005$

Notes:

- Case material: Plastic.
- Termination finish:
For RoHS Case Styles: Tin-Silver alloy plate over Nickel barrier.
(Unless stated otherwise on Data sheet).



INTERNET <http://www.minicircuits.com>

P.O. Box 350166, Brooklyn, New York 11235-0003 (718) 934-4500 Fax (718) 332-4661

Distribution Centers NORTH AMERICA 800-654-7949 • 417-335-5935 • Fax 417-335-5945 • EUROPE 44-1252-832600 • Fax 44-1252-837010

Mini-Circuits ISO 9001 & ISO 14001 Certified

Tape & Reel Packaging TR-F31

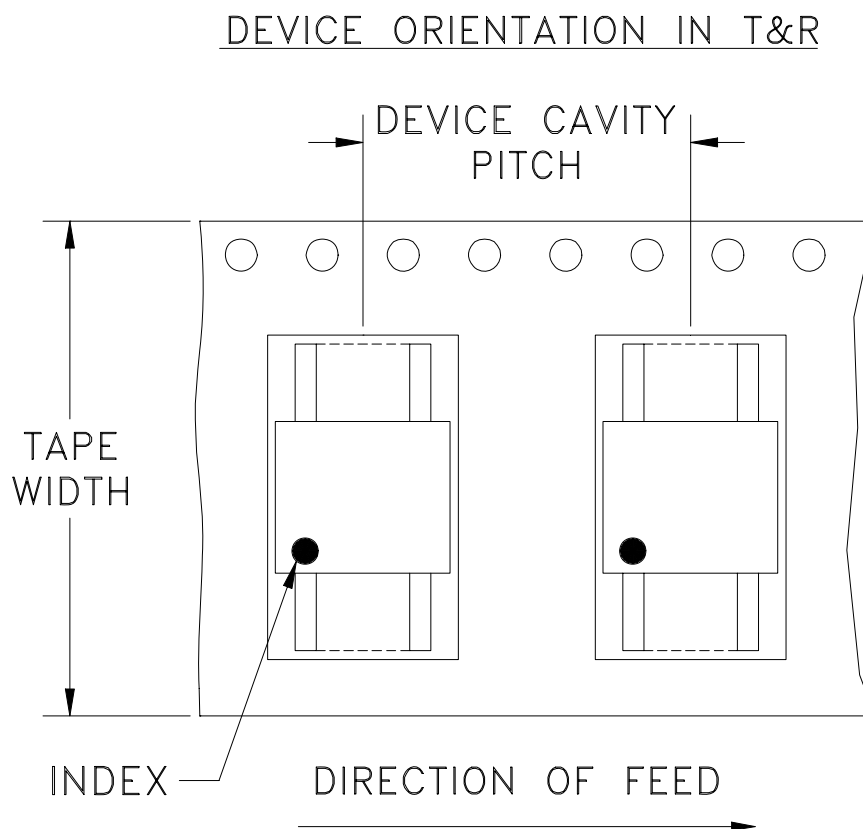

Tape Width, mm	Device Cavity Pitch, mm	Reel Size, inches	Devices per Reel	
8	4	7	Small quantity standards (see note)	20
				50
				100
				200
				500
			Standard	1000

Note: Please Consult individual model data sheet to determine device per reel availability

Mini-Circuits carrier tape materials provide protection from ESD (Electro-Static Discharge) during handling and transportation. Tapes are static dissipative and comply with industry standards EIA-481/EIA-541.

Go to: www.minicircuits.com/pages/pdfs/tape.pdf



INTERNET <http://www.minicircuits.com>

P.O. Box 350166, Brooklyn, New York 11235-0003 (718) 934-4500 Fax (718) 332-4661

Distribution Centers NORTH AMERICA 800-654-7949 • 417-335-5935 • Fax 417-335-5945 • EUROPE 44-1252-832600 • Fax 44-1252-837010

Mini-Circuits ISO 9001 & ISO 14001 Certified

THIRD ANGLE PROJECTION

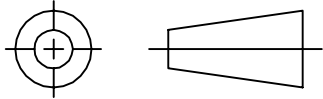

REVISIONS

REV	ECN No.	DESCRIPTION	DATE	DR	AUTH
OR	M110291	NEW RELEASE	03/20/07	AV	WP

SUGGESTED MOUNTING CONFIGURATION FOR CA531 CASE STYLE, "jn" PIN CONNECTION

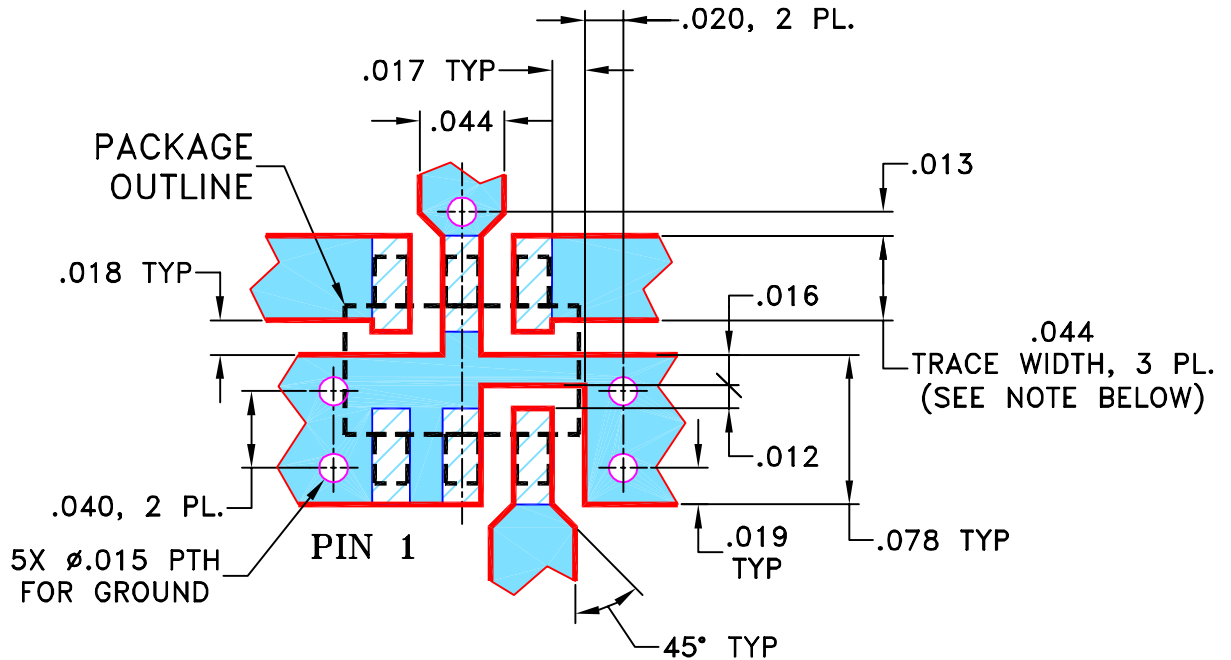

NOTES: 1. TRACE WIDTH IS SHOWN FOR ROGERS R04350B WITH DIELECTRIC THICKNESS 0.020" ± 0.0015". COPPER: 1/2 OZ. EACH SIDE. FOR OTHER MATERIALS TRACE WIDTH MAY NEED TO BE MODIFIED.

2. BOTTOM SIDE OF THE PCB IS CONTINUOUS GROUND PLANE.

 DENOTES PCB COPPER LAYOUT WITH SMOBC (SOLDER MASK OVER BARE COPPER)

 DENOTES COPPER LAND PATTERN FREE OF SOLDER MASK

UNLESS OTHERWISE SPECIFIED	INITIALS	DATE
DIMENSIONS ARE IN INCHES	DRAWN AV	03/07/07
TOLERANCES ON:	CHECKED IL	03/20/07
2 PL DECIMALS ±	APPROVED WP	03/20/07
3 PL DECIMALS ± .005		
ANGLES ±		
FRACTIONS ±		

 **Mini-Circuits®** 13 Neptune Avenue
Brooklyn NY 11235

PL, jn, CA531, D20C+, TB-396+

 Mini-Circuits®
THIS DOCUMENT AND ITS CONTENTS ARE THE PROPERTY OF MINI-CIRCUITS. EXCEPT FOR USE EXPRESSLY GRANTED, IN WRITING, TO ITS VENDORS, VENDEE AND THE UNITED STATES GOVERNMENT, MINI-CIRCUITS RESERVES ALL PROPRIETARY DESIGN, USE, MANUFACTURING AND REPRODUCTION RIGHTS THERETO. THESE CONTENTS SHALL NOT BE USED, DUPLICATED OR DISCLOSED TO ANY OUTSIDE PARTY, IN WHOLE OR IN PART, WITHOUT WRITTEN PERMISSION OF MINI-CIRCUITS.

SIZE A	CODE IDENT 15542	DRAWING NO: 98-PL-270	REV: OR
FILE: 98PL270	SCALE: 10:1	SHEET: 1 OF 1	

Evaluation Board and Circuit

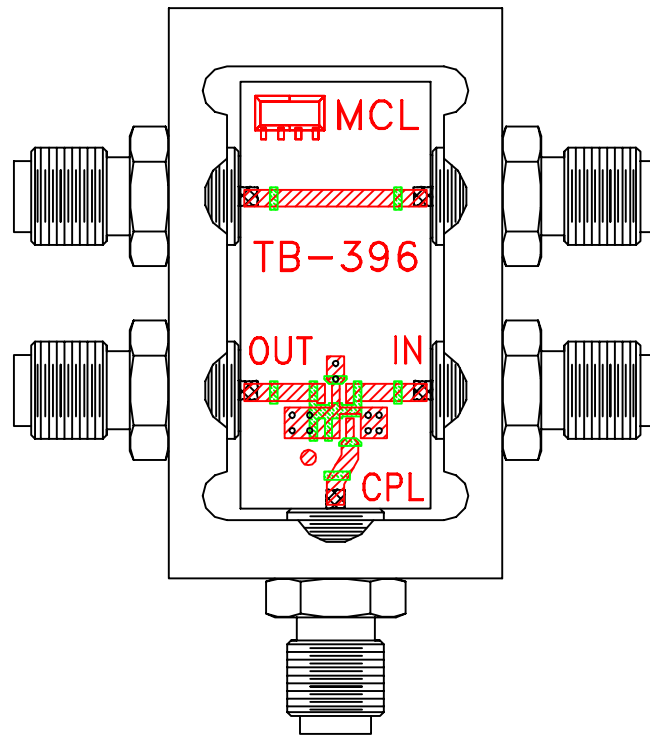

TB-396+

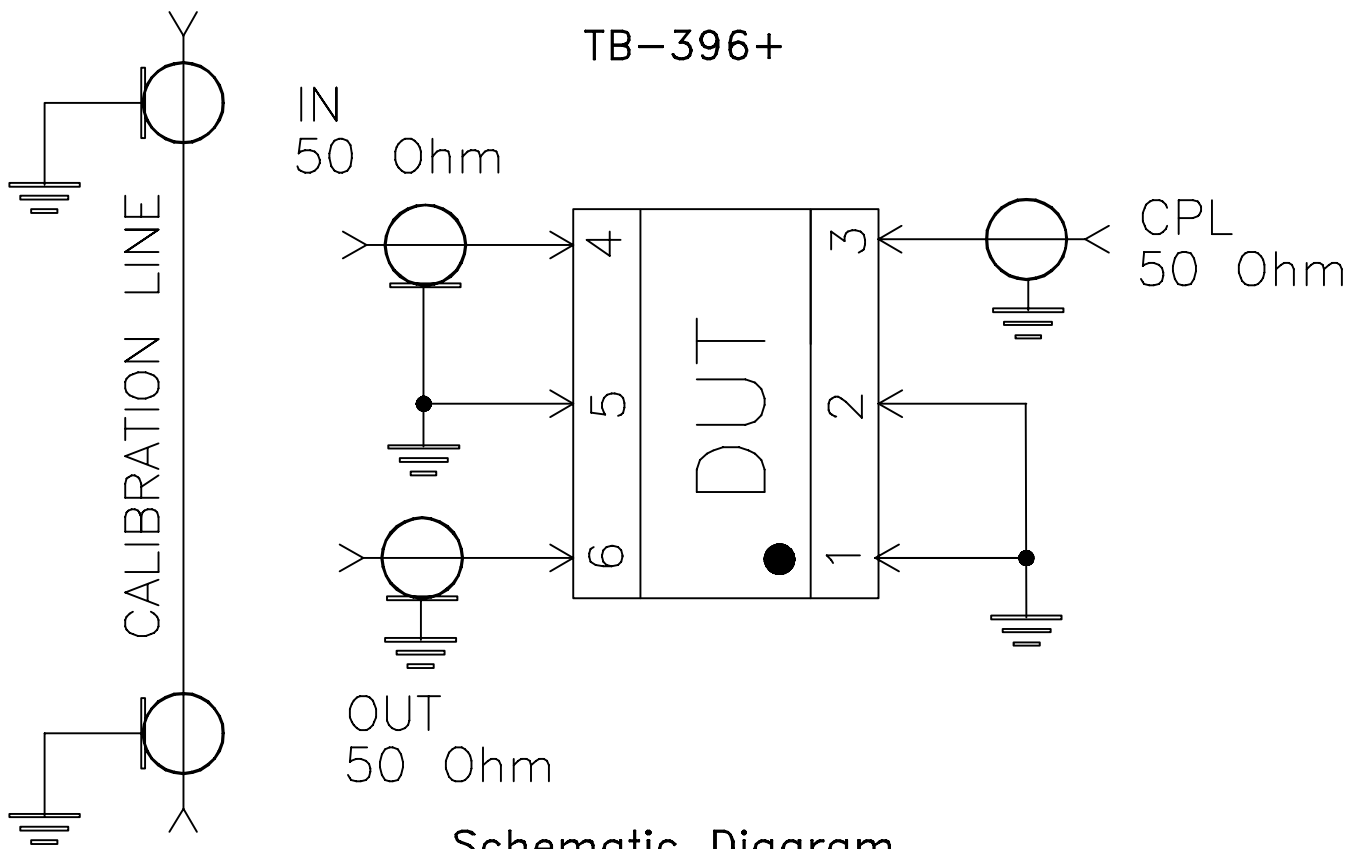

Schematic Diagram

Notes:

1. 50 Ohm SMA Female connectors.
2. PCB Material: Rogers R04350B or its equivalent, Dielectric Constant=3.5, Thickness=.020"

 Mini-Circuits®



All Mini-Circuits products are manufactured under exacting quality assurance and control standards, and are capable of meeting published specifications after being subjected to any or all of the following physical and environmental test.

Specification	Test/Inspection Condition	Reference/Spec
Operating Temperature	-40° to 105° C Ambient Environment	Individual Model Data sheet
Storage Temperature	-65° to 150° C Ambient Environment	Individual Model Data Sheet
Autoclave	15 psig, 100% RH, 121°C, 96 hours	JESD22-A102-C, Condition C
Temperature Cycling	-65° to 150°C, 100 cycles	JESD22-A104
Temperature Humidity	85°C/ 85% RH, 168 hours	JESD22-113
Solder Reflow Heat	Sn-Pb Eutetic Process: 240°C peak Pb-Free Process: 260°C peak	J-STD-020C, Table 4-1, 4-2 and 5-2; Figure 5-1
Moisture Sensitivity: Level 1	Bake at 125°C for 24 hours Soak at 85°C/85% RH for 168 hours, Reflow 3 cycles at 240°C peak (Non-RoHS) or 260°C (RoHS)	J-STD-020
Solderability	10X magnification, 95% coverage	JESD22-B102, Method 1: Dip and Look Test
Mechanical Shock	50g, 11 ms, 1/2-sine, 18 shocks: 3 each direction, each of 3 axes	MIL-STD-202, Method 213, Condition A
Vibration (High Frequency)	20g peak, 10-2000 Hz, 12 times in each of three perpendicular directions (total 36)	MIL-STD-202, Method 204, Condition D