

Surface Mount Bandpass Filter

CBP-1538J+

50Ω 1518 to 1559 MHz

The Big Deal

- Good Insertion Loss
- Low VSWR
- Miniature shielded package

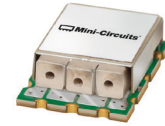

Generic photo used for illustration purposes only
CASE STYLE: MQ1770

Product Overview

CBP-1538J+ is a ceramic coaxial resonator based bandpass filter in a shielded package fabricated using SMT technology. This filter has narrow passband and offers low insertion loss, low VSWR and high power handling for use in satellite communication.

Key Features

Feature	Advantages
High Quality	The CBP-1538J+ filter incorporates High-Q ceramic resonators that enables low insertion loss.
Low VSWR	This filter maintains typical VSWR over passband frequency range making this filter easier to integrate between other components.
Rugged construction	The CBP-1538J+ has been qualified over wide range of thermal, mechanical and environmental conditions including withstanding the stress of extensive solder reflow cycles.

Notes

- A. Performance and quality attributes and conditions not expressly stated in this specification document are intended to be excluded and do not form a part of this specification document.
B. Electrical specifications and performance data contained in this specification document are based on Mini-Circuit's applicable established test performance criteria and measurement instructions.
C. The parts covered by this specification document are subject to Mini-Circuits standard limited warranty and terms and conditions (collectively, "Standard Terms"); Purchasers of this part are entitled to the rights and benefits contained therein. For a full statement of the Standard Terms and the exclusive rights and remedies thereunder, please visit Mini-Circuits' website at www.minicircuits.com/MCLStore/terms.jsp



Surface Mount Bandpass Filter

CBP-1538J+

50Ω 1518 to 1559 MHz

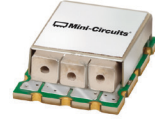

Generic photo used for illustration purposes only
CASE STYLE: MQ1770

Features

- Good Insertion loss
- Low VSWR
- Miniature shielded package

Applications

- Satellite communication
- Test and measurement

Electrical Specifications at 25°C

Parameter	F#	Frequency (MHz)	Min.	Typ.	Max.	Unit	
Pass Band	Center Frequency	—	—	1538	—	MHz	
	Insertion Loss	F1-F2	1518-1559	—	1.1	1.7	dB
	VSWR	F1-F2	1518-1559	—	1.6	2.32	:1
Stop Band, Lower	Insertion Loss	DC-F3	DC-1390	20	27.4	—	dB
	VSWR	DC-F3	DC-1390	—	20	—	:1
Stop Band, Upper	Insertion Loss	F4-F5	1750-3000	20	25.9	—	dB
	VSWR	F4-F5	1750-3000	—	20	—	:1

Maximum Ratings

Operating Temperature	-40°C to 85°C
Storage Temperature	-55°C to 100°C
RF Power Input	8 W

Permanent damage may occur if any of these limits are exceeded.

Functional Schematic

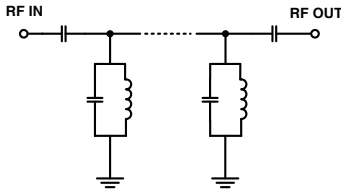

Typical Frequency Response

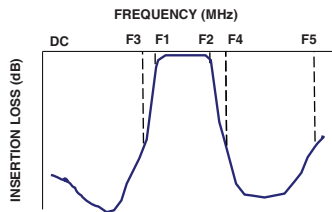

Typical Performance Data at 25°C

Frequency (MHz)	Insertion Loss (dB)	VSWR (:1)	Frequency (MHz)	Group Delay (nsec)
1	98.71	1737.18	1518	5.76
100	94.35	1737.18	1520	5.71
800	72.86	217.15	1522	5.67
1150	59.03	115.81	1524	5.63
1384	30.08	57.91	1526	5.60
1390	28.64	54.29	1528	5.57
1421	20.88	36.97	1530	5.54
1475	3.30	3.08	1534	5.49
1500	1.13	1.23	1538	5.43
1518	1.02	1.23	1540	5.41
1538	0.92	1.09	1542	5.38
1559	0.96	1.29	1544	5.36
1605	3.50	3.92	1546	5.34
1686	20.14	54.98	1548	5.32
1750	28.30	75.53	1550	5.31
1770	30.34	78.97	1552	5.30
1800	33.12	82.73	1554	5.30
2500	42.61	57.91	1556	5.32
3000	36.56	46.96	1558	5.34
4000	19.60	28.49	1559	5.35

+RoHS Compliant

The +Suffix identifies RoHS Compliance. See our web site for RoHS Compliance methodologies and qualifications

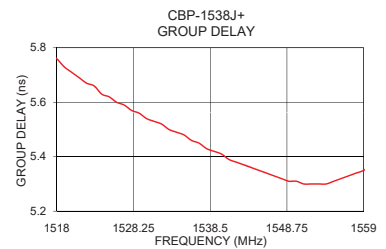
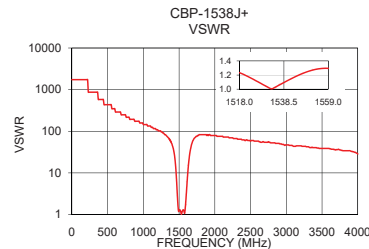
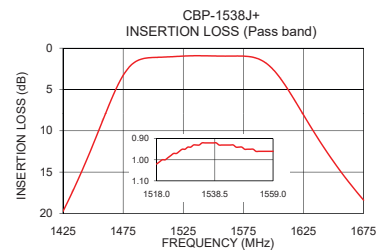
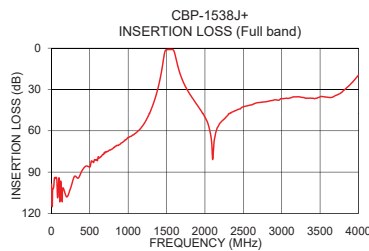

Notes

- Performance and quality attributes and conditions not expressly stated in this specification document are intended to be excluded and do not form a part of this specification document.
- Electrical specifications and performance data contained in this specification document are based on Mini-Circuits' applicable established test performance criteria and measurement instructions.
- The parts covered by this specification document are subject to Mini-Circuits standard limited warranty and terms and conditions (collectively, "Standard Terms"); Purchasers of this part are entitled to the rights and benefits contained therein. For a full statement of the Standard Terms and the exclusive rights and remedies thereunder, please visit Mini-Circuits' website at www.minicircuits.com/MCLStore/terms.jsp



www.minicircuits.com P.O. Box 350166, Brooklyn, NY 11235-0003 (718) 934-4500 sales@minicircuits.com

REV.A
M174392
CBP-1538J+
EDU1736/1
URJ
200813
Page 2 of 3

Pad Connections

INPUT	1
OUTPUT	9
GROUND	2,3,4,5,6,7,8,10,11

Demo Board MCL P/N: TB-692+ Suggested PCB Layout (PL-375)

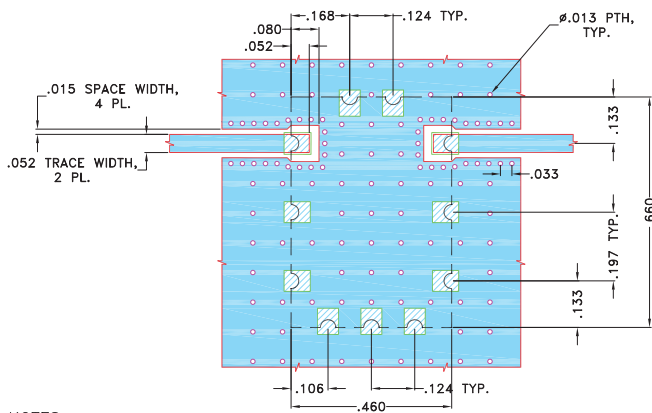

- NOTES:
- TRACE WIDTH IS SHOWN FOR ROGERS (RO4350B) WITH DIELECTRIC THICKNESS .030"±.002". COPPER: 1/2 OZ. EACH SIDE. FOR OTHER MATERIALS TRACE WIDTH MAY NEED TO BE MODIFIED.
 - BOTTOM SIDE OF THE PCB IS CONTINUOUS GROUND PLANE.

- DENOTES PCB COPPER LAYOUT WITH SMOBC (SOLDER MASK OVER BARE COPPER)
- DENOTES COPPER LAND PATTERN FREE OF SOLDERMASK

Outline Drawing

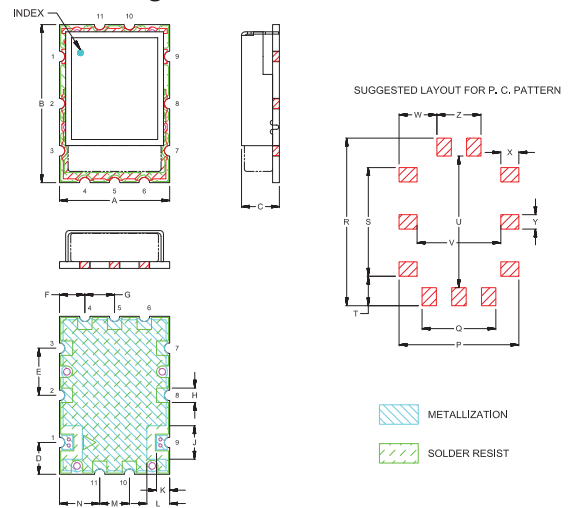

Outline Dimensions (inch mm)

A	B	C	D	E	F	G	H	J	K	L	M	N
.460	.660	.175	.133	.197	.106	.124	.060	.140	.055	.095	.124	.168
11.68	16.76	4.45	3.38	5.00	2.69	3.15	1.52	3.56	1.40	2.41	3.15	4.27
P	Q	R	S	T	U	V	W	X	Y	Z	WT.GRAMS	
.500	.308	.700	.454	.123	.550	.350	.158	.075	.060	.184	1.8	
12.70	7.82	17.78	11.53	3.12	13.97	8.89	4.01	1.91	1.52	4.67		

Note: Please refer to case style drawing for details.

Notes

- Performance and quality attributes and conditions not expressly stated in this specification document are intended to be excluded and do not form a part of this specification document.
- Electrical specifications and performance data contained in this specification document are based on Mini-Circuit's applicable established test performance criteria and measurement instructions.
- The parts covered by this specification document are subject to Mini-Circuits standard limited warranty and terms and conditions (collectively, "Standard Terms"); Purchasers of this part are entitled to the rights and benefits contained therein. For a full statement of the Standard Terms and the exclusive rights and remedies thereunder, please visit Mini-Circuits' website at www.minicircuits.com/MCLStore/terms.jsp

Band Pass Filter

CBP-1538J+

Typical Performance Data

FREQ. (MHz)	INSERTION LOSS			INPUT RETURN LOSS			OUTPUT RETURN LOSS		
	(dB)			(dB)			(dB)		
	@-40°C	@+25°C	@+85°C	@-40°C	@+25°C	@+85°C	@-40°C	@+25°C	@+85°C
1	113.36	98.71	103.52	0.00	0.00	0.00	0.00	0.00	0.00
270	101.25	108.53	104.27	0.00	0.02	0.03	0.00	0.02	0.02
490	86.22	84.51	84.48	0.01	0.04	0.05	0.01	0.04	0.05
550	82.51	82.98	82.25	0.01	0.04	0.06	0.02	0.05	0.06
1000	64.66	64.85	65.03	0.06	0.12	0.14	0.09	0.14	0.17
1050	63.54	63.51	63.52	0.06	0.12	0.15	0.10	0.15	0.18
1240	51.78	51.61	51.70	0.11	0.17	0.20	0.15	0.22	0.25
1330	40.16	39.97	39.86	0.15	0.23	0.26	0.20	0.27	0.31
1360	35.02	34.78	34.60	0.19	0.26	0.30	0.23	0.31	0.35
1415	22.96	22.53	22.19	0.32	0.43	0.49	0.38	0.49	0.55
1435	17.23	16.71	16.29	0.50	0.64	0.74	0.56	0.71	0.81
1450	12.25	11.66	11.21	0.87	1.11	1.29	0.94	1.19	1.37
1465	6.81	6.28	5.93	2.14	2.72	3.15	2.26	2.85	3.30
1470	5.09	4.66	4.40	3.15	3.95	4.55	3.31	4.14	4.76
1475	3.58	3.30	3.15	4.74	5.86	6.66	4.98	6.15	6.99
1481	2.21	2.15	2.13	7.84	9.46	10.51	8.29	10.05	11.20
1486	1.51	1.58	1.64	11.81	13.91	15.12	12.80	15.36	16.83
1493	1.07	1.23	1.34	19.41	21.29	22.32	26.00	33.36	34.71
1494	1.04	1.21	1.31	20.23	21.71	22.70	29.22	34.07	33.59
1495	1.01	1.19	1.29	20.72	21.77	22.77	31.01	30.61	30.40
1505	0.93	1.10	1.19	17.05	18.09	19.98	17.66	18.40	19.91
1508	0.93	1.09	1.17	16.38	17.76	19.97	16.67	17.78	19.52
1512	0.91	1.06	1.14	16.11	17.96	20.74	16.16	17.70	19.76
1518	0.88	1.02	1.10	16.81	19.60	23.92	16.59	18.82	21.41
1519	0.87	1.01	1.10	17.04	20.05	24.78	16.78	19.14	21.80
1520	0.86	1.00	1.09	17.32	20.55	25.79	17.02	19.52	22.22
1528	0.79	0.95	1.05	21.12	28.38	41.25	20.11	23.75	24.39
1533	0.75	0.93	1.05	26.01	52.54	26.33	23.40	25.85	22.56
1534	0.75	0.92	1.05	27.46	40.07	25.04	24.17	25.79	22.02
1538	0.73	0.92	1.06	37.87	27.72	21.33	27.01	24.10	19.98
1541	0.73	0.93	1.07	36.57	24.02	19.50	27.34	22.34	18.69
1545	0.72	0.93	1.08	27.69	21.06	17.81	25.26	20.34	17.39
1554	0.74	0.96	1.11	21.35	18.07	16.13	21.05	17.95	16.04
1557	0.74	0.96	1.11	20.63	17.81	16.12	20.45	17.75	16.08
1559	0.74	0.96	1.11	20.42	17.83	16.28	20.29	17.81	16.27
1568	0.75	0.96	1.09	22.39	20.35	19.25	22.07	20.34	19.33
1576	0.76	0.98	1.12	35.13	30.11	28.01	27.68	27.75	27.29
1577	0.77	0.99	1.13	36.05	30.56	27.93	27.39	27.66	26.97
1580	0.80	1.03	1.18	26.64	24.70	22.81	23.61	23.31	22.19
1582	0.84	1.07	1.24	22.30	20.87	19.40	20.71	20.11	19.02
1584	0.88	1.14	1.32	19.13	17.91	16.67	18.16	17.43	16.41
1592	1.28	1.63	1.91	11.22	10.39	9.62	10.97	10.26	9.54
1595	1.54	1.94	2.27	9.28	8.55	7.90	9.10	8.47	7.85
1602	2.41	2.95	3.39	5.95	5.46	5.05	5.86	5.43	5.02
1610	3.86	4.53	5.06	3.59	3.33	3.11	3.55	3.32	3.10
1620	6.11	6.86	7.44	1.97	1.89	1.81	1.96	1.90	1.82
1625	7.30	8.07	8.66	1.49	1.48	1.43	1.50	1.49	1.45
1630	8.50	9.27	9.85	1.16	1.18	1.16	1.17	1.20	1.18
1650	13.00	13.72	14.24	0.51	0.59	0.62	0.54	0.63	0.66
1660	15.01	15.70	16.19	0.38	0.47	0.51	0.42	0.51	0.54
1675	17.73	18.38	18.82	0.27	0.36	0.41	0.31	0.40	0.44
1680	18.57	19.20	19.63	0.25	0.34	0.38	0.29	0.39	0.42
1720	24.31	24.85	25.19	0.16	0.25	0.29	0.21	0.30	0.34
1800	32.69	33.12	33.38	0.13	0.21	0.25	0.19	0.27	0.30
2100	77.44	80.75	90.00	0.15	0.23	0.26	0.21	0.28	0.31
2170	57.17	57.08	56.80	0.16	0.24	0.27	0.22	0.29	0.31
2590	41.35	41.28	41.25	0.20	0.30	0.34	0.23	0.33	0.36
2650	40.25	40.20	40.30	0.21	0.32	0.36	0.24	0.34	0.37
2800	38.89	38.86	38.82	0.22	0.33	0.39	0.24	0.35	0.40
3000	36.50	36.56	36.82	0.24	0.37	0.45	0.24	0.37	0.44



Band Pass Filter**CBP-1538J+***Typical Performance Data*

FREQ. (MHz)	GROUP DELAY		
	(nsec)		
	@-40°C	@+25°C	@+85°C
1518	5.78	5.76	5.76
1519	5.75	5.73	5.74
1520	5.72	5.71	5.71
1521	5.70	5.69	5.70
1522	5.68	5.67	5.67
1523	5.66	5.66	5.66
1524	5.64	5.63	5.63
1525	5.62	5.62	5.62
1526	5.61	5.60	5.60
1527	5.60	5.59	5.58
1528	5.58	5.57	5.57
1529	5.57	5.56	5.55
1530	5.56	5.54	5.53
1531	5.55	5.53	5.52
1532	5.54	5.52	5.50
1533	5.53	5.50	5.48
1534	5.51	5.49	5.46
1535	5.50	5.48	5.45
1536	5.49	5.46	5.43
1537	5.48	5.45	5.41
1538	5.46	5.43	5.39
1539	5.46	5.42	5.38
1540	5.45	5.41	5.37
1541	5.43	5.39	5.35
1542	5.42	5.38	5.34
1543	5.41	5.37	5.33
1544	5.40	5.36	5.31
1545	5.39	5.35	5.30
1546	5.38	5.34	5.29
1547	5.38	5.33	5.28
1548	5.36	5.32	5.28
1549	5.36	5.31	5.27
1550	5.36	5.31	5.27
1551	5.35	5.30	5.27
1552	5.34	5.30	5.27
1553	5.34	5.30	5.27
1554	5.35	5.30	5.29
1555	5.34	5.31	5.29
1556	5.35	5.32	5.30
1557	5.35	5.33	5.32
1558	5.36	5.34	5.34
1559	5.37	5.35	5.36

Typical Performance Curves

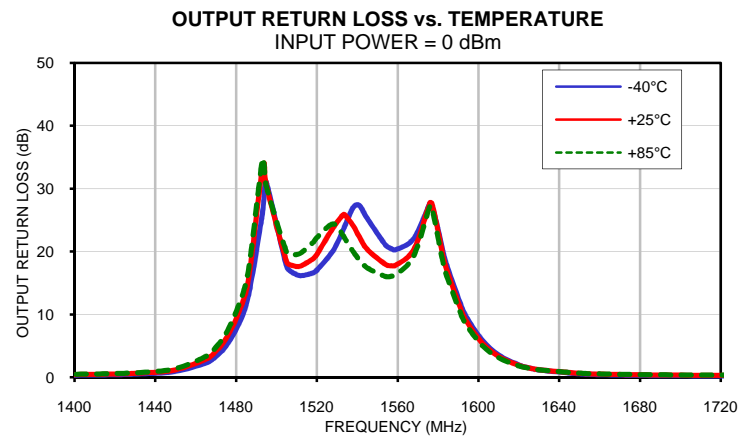
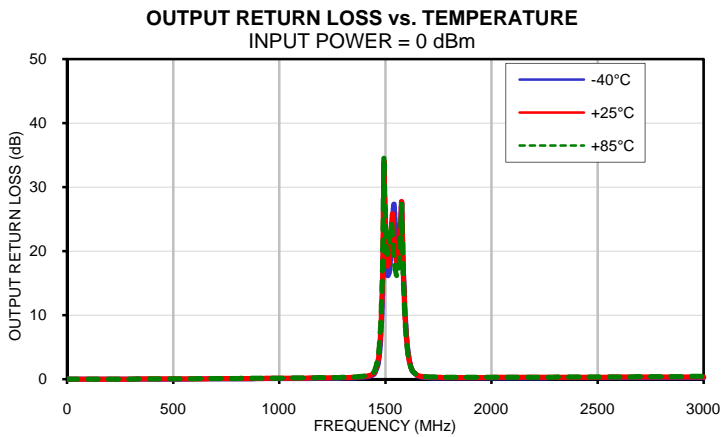
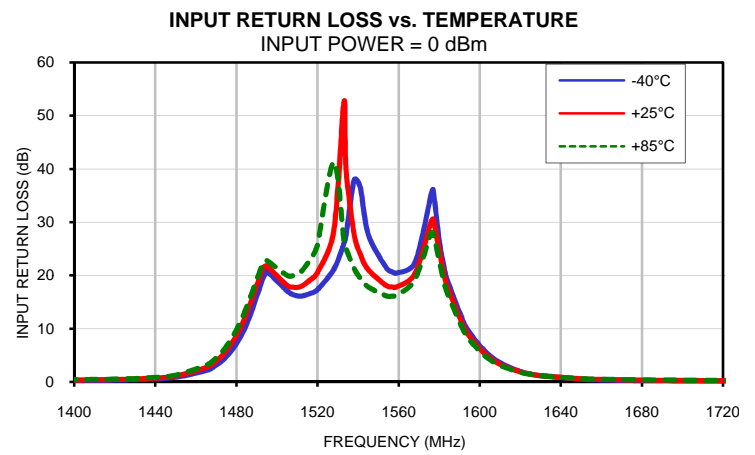
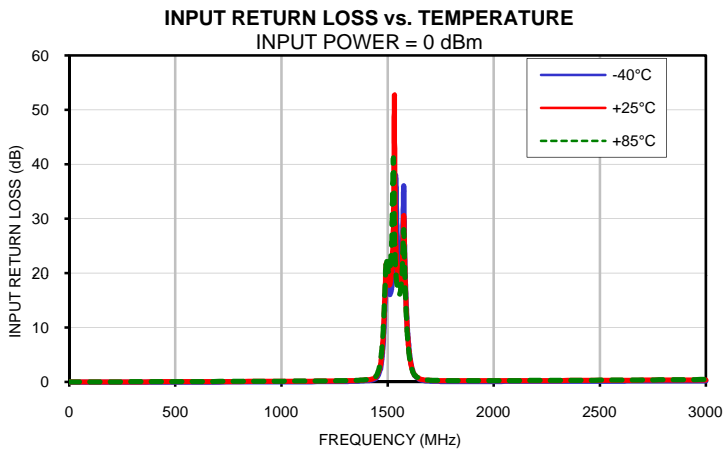
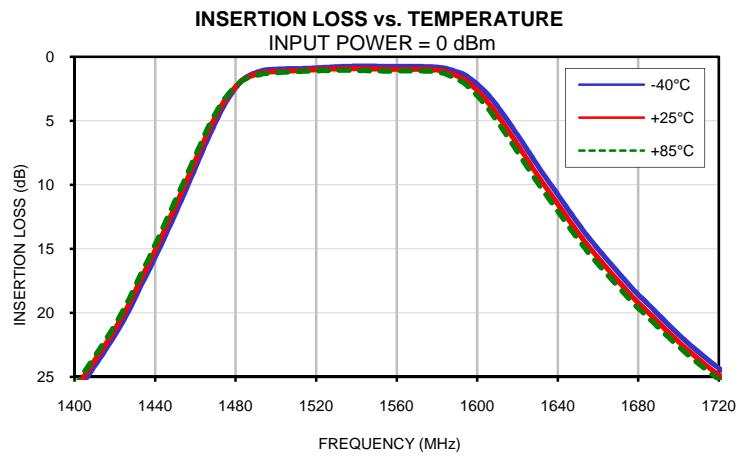
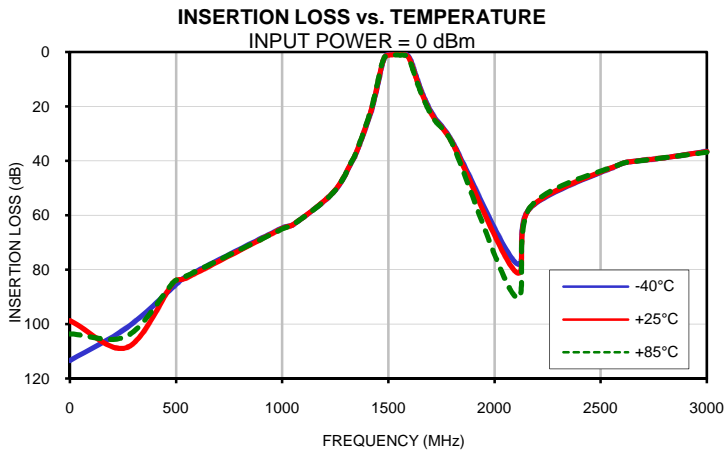

Typical Performance Curves

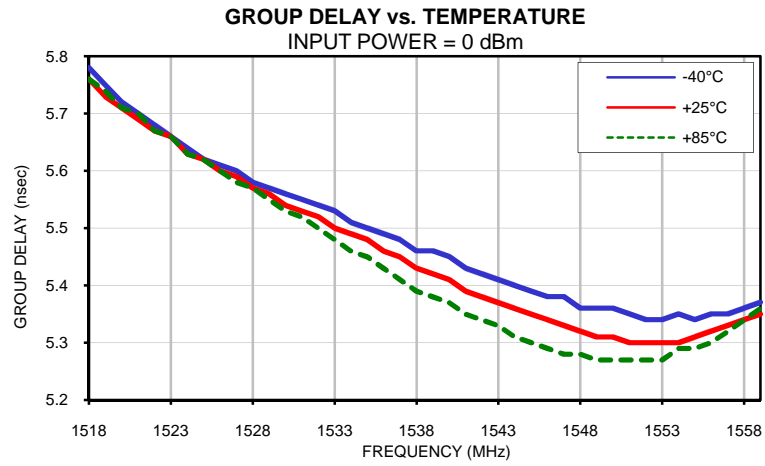

Outline Dimensions

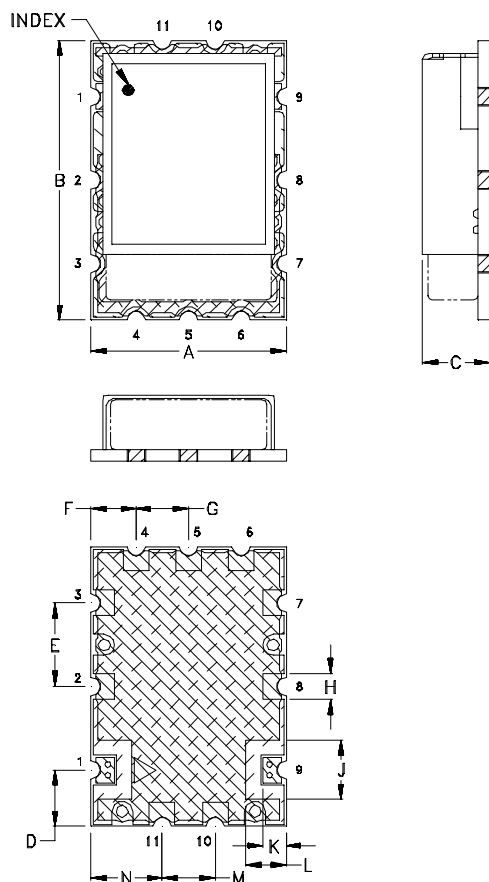

PCB Land Pattern

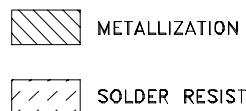
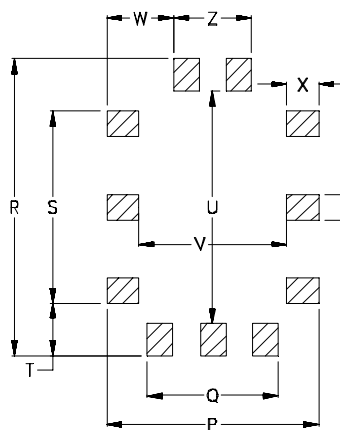

CASE#	A	B	C	D	E	F	G	H	J	K	L	M	N
MQ1770	.460 (11.68)	.660 (16.76)	.175 (4.45)	.133 (3.38)	.197 (5.00)	.106 (2.69)	.124 (3.15)	.060 (1.52)	.140 (3.56)	.055 (1.40)	.095 (2.41)	.124 (3.15)	.168 (4.27)

CASE#	P	Q	R	S	T	U	V	W	X	Y	Z	WT,GRAMS
MQ1770	.500 (12.70)	.308 (7.82)	.700 (17.78)	.454 (11.53)	.123 (3.12)	.550 (13.97)	.350 (8.89)	.158 (4.01)	.075 (1.91)	.060 (1.52)	.184 (4.67)	1.8

Dimensions are in inches (mm). Tolerances: 2PL. $\pm .03$; 3PL. $\pm .015$

Notes:

- Case material: Nickel-Silver alloy.
- Base: Printed wiring laminate.
- Termination finish:
For RoHS Case Styles: 2-5 μ inch (.05-.13 microns) Gold over 120-240 μ inch (3.05-6.10 microns) Nickel plate.
All models, (+) suffix.



INTERNET <http://www.minicircuits.com>

P.O. Box 350166, Brooklyn, New York 11235-0003 (718) 934-4500 Fax (718) 332-4661

Distribution Centers NORTH AMERICA 800-654-7949 • 417-335-5935 • Fax 417-335-5945 • EUROPE 44-1252-832600 • Fax 44-1252-837010

Mini-Circuits ISO 9001 & ISO 14001 Certified

Tape & Reel Packaging TR-F5

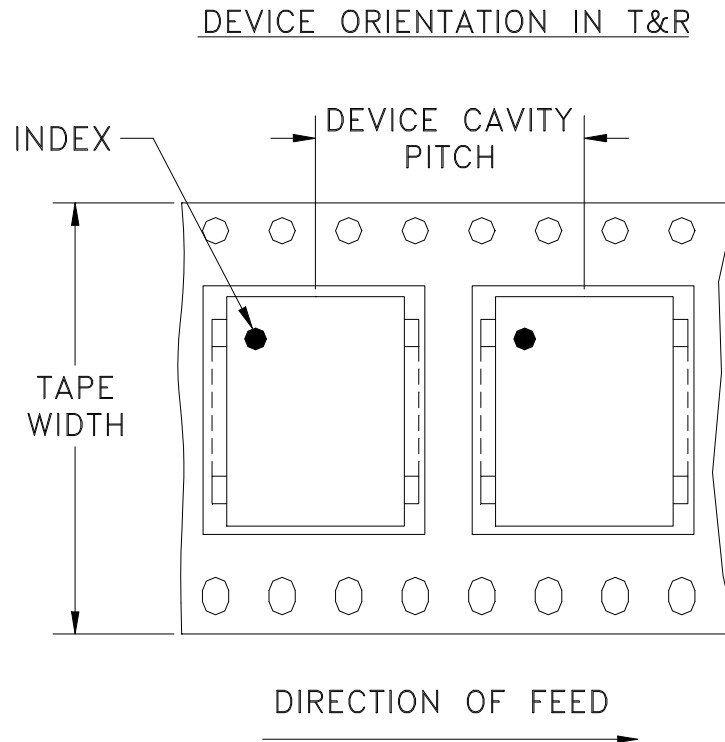

Tape Width, mm	Device Cavity Pitch, mm	Reel Size, inches	Devices per Reel
32	16	13	500

Mini-Circuits carrier tape materials provide protection from ESD (Electro-Static Discharge) during handling and transportation. Tapes are static dissipative and comply with industry standards EIA-481/EIA-541.

Go to: www.minicircuits.com/pages/pdfs/tape.pdf



Distribution Centers NORTH AMERICA 800-654-7949 • 417-335-5935 • Fax 417-335-5945 • EUROPE 44-1252-832600 • Fax 44-1252-837010

Mini-Circuits ISO 9001 & ISO 14001 Certified

INTERNET <http://www.minicircuits.com>

P.O. Box 350166, Brooklyn, New York 11235-0003 (718) 934-4500 Fax (718) 332-4661

THIRD ANGLE PROJECTION

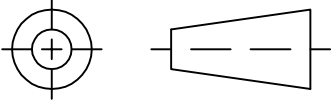

REVISIONS

REV OR	ECN No.	DESCRIPTION	DATE	DR	AUTH
	M137891	NEW RELEASE	JUL 12	DDR	KG

SUGGESTED MOUNTING CONFIGURATION FOR MQ1770 CASE STYLE "11FL01" PIN CODE

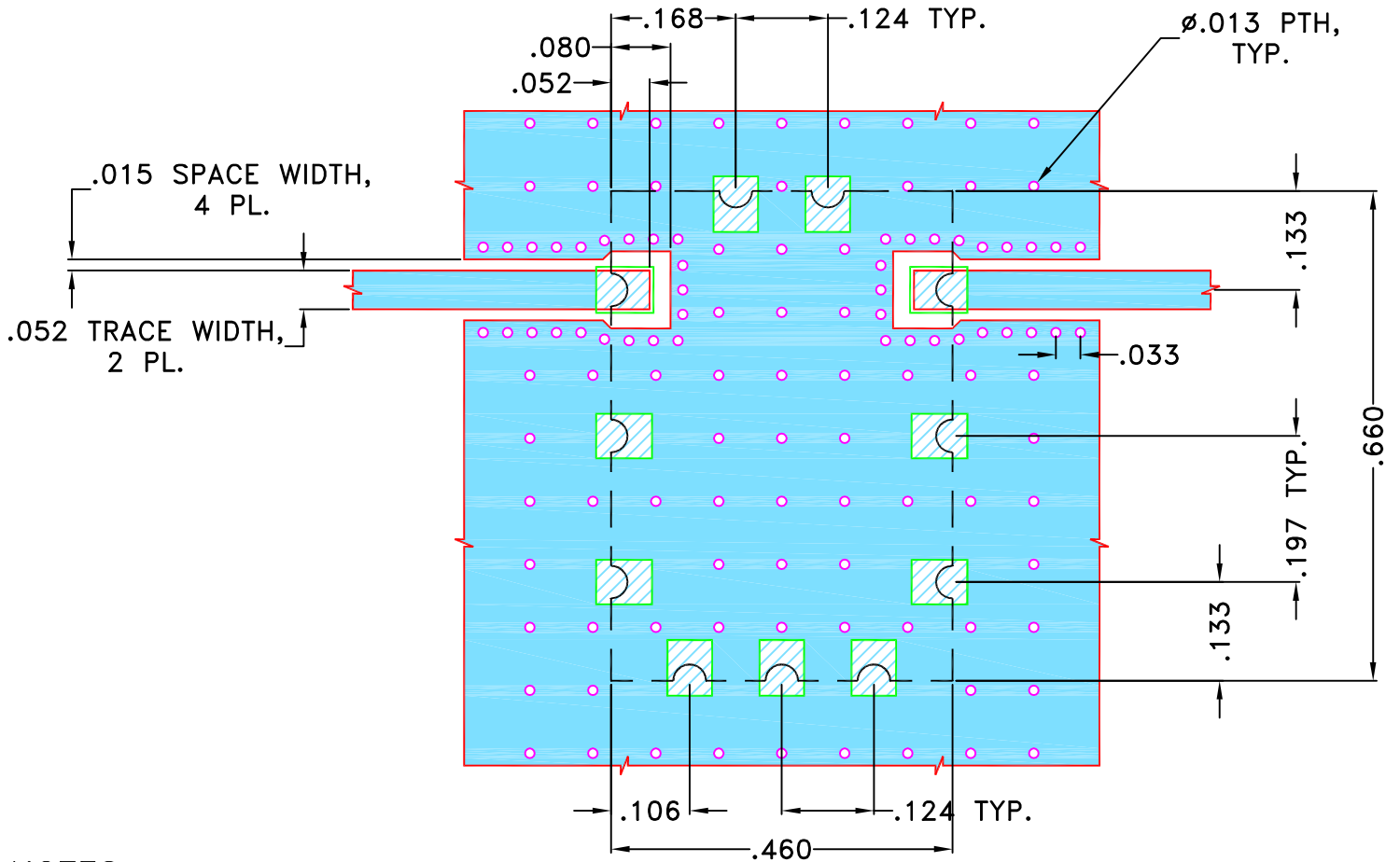

NOTES:

1. TRACE WIDTH IS SHOWN FOR ROGERS (R04350B) WITH DIELECTRIC THICKNESS .030"±.002". COPPER: 1/2 OZ. EACH SIDE. FOR OTHER MATERIALS TRACE WIDTH MAY NEED TO BE MODIFIED.
2. BOTTOM SIDE OF THE PCB IS CONTINUOUS GROUND PLANE.

DENOTES PCB COPPER LAYOUT WITH SMOBC (SOLDER MASK OVER BARE COPPER)

DENOTES COPPER LAND PATTERN FREE OF SOLDERMASK

UNLESS OTHERWISE SPECIFIED	INITIALS	DATE
DIMENSIONS ARE IN INCHES	DRAWN DDR	06 JUL 12
TOLERANCES ON:	CHECKED MD	06 JUL 12
2 PL DECIMALS ±	APPROVED KR	06 JUL 12
3 PL DECIMALS ± .005		
ANGLES ±		
FRACTIONS ±		

Mini-Circuits® 13 Neptune Avenue
Brooklyn NY 11235

**PL,11FL01, MQ1770, BPF,
TB-692+, 50 Ohm**

SIZE A	CODE IDENT 15542	DRAWING NO: 98-PL-375	REV: OR
FILE: 98PL375	SCALE: 4:1	SHEET: 1 OF 1	

Mini-Circuits®
THIS DOCUMENT AND ITS CONTENTS ARE THE PROPERTY OF MINI-CIRCUITS. EXCEPT FOR USE EXPRESSLY GRANTED, IN WRITING, TO ITS VENDORS, VENDEE AND THE UNITED STATES GOVERNMENT, MINI-CIRCUITS RESERVES ALL PROPRIETARY DESIGN, USE, MANUFACTURING AND REPRODUCTION RIGHTS THERETO. THESE CONTENTS SHALL NOT BE USED, DUPLICATED OR DISCLOSED TO ANY OUTSIDE PARTY, IN WHOLE OR IN PART, WITHOUT WRITTEN PERMISSION OF MINI-CIRCUITS.

Evaluation Board and Circuit

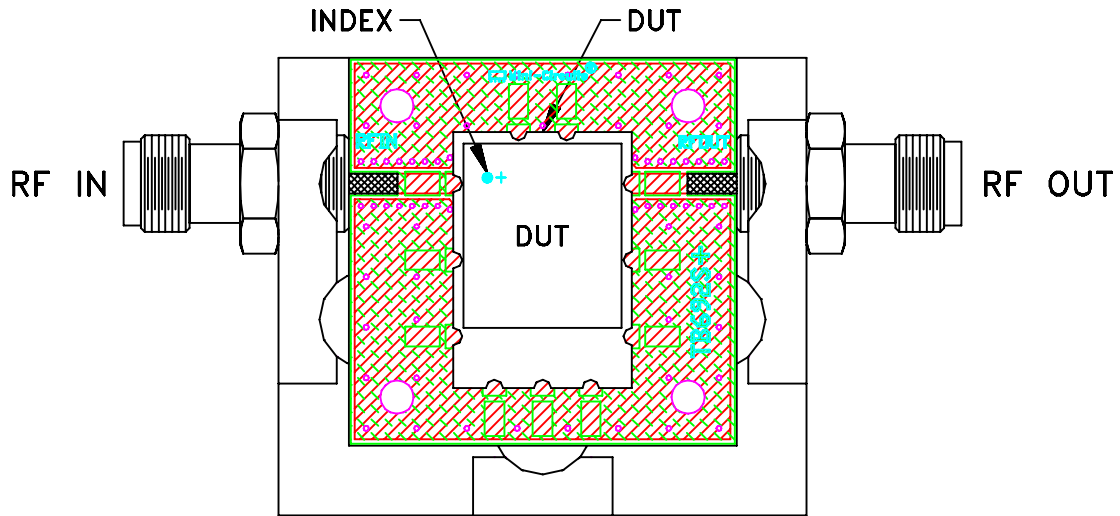

TB-692+

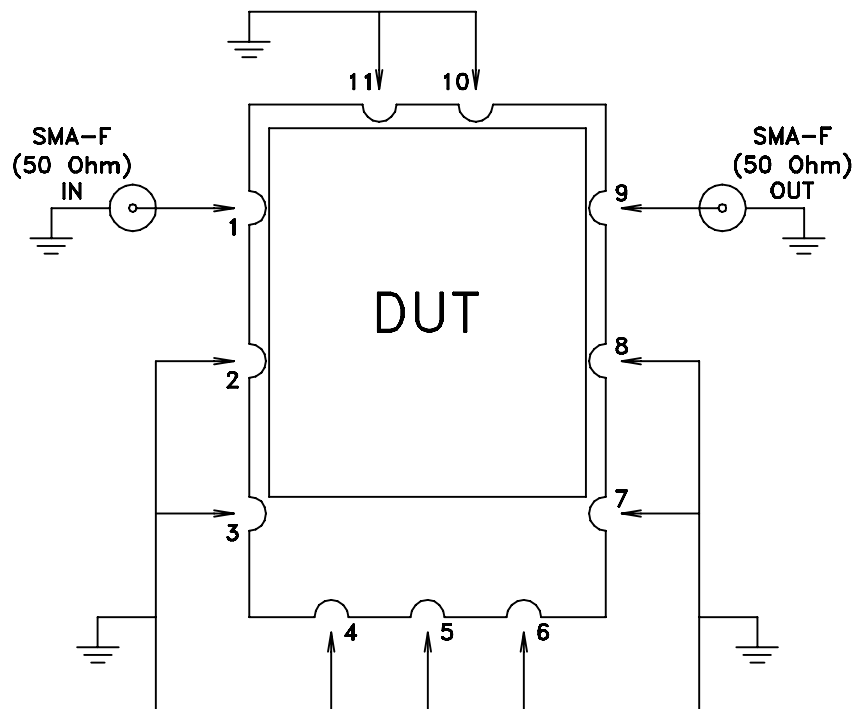

Schematic Diagram

Notes:

1. 50 Ohm SMA Female connectors.
2. PCB Material: ROGERS (R04350B) OR Equivalent
Dielectric Constant= 3.48 ± 0.05 , Thickness= $.030$ inch.

 **Mini-Circuits®**

All Mini-Circuits products are manufactured under exacting quality assurance and control standards, and are capable of meeting published specifications after being subjected to any or all of the following physical and environmental test.

Specification	Test/Inspection Condition	Reference/Spec
Operating Temperature	-40° to 85°C Ambient Environment	Individual Model Data Sheet
Storage Temperature	-55° to 100° C Ambient Environment	Individual Model Data Sheet
Humidity	90 to 95% RH, 96 hours, 40°C	MIL-STD-202, Method 103B, Condition B, Except 50°C
Thermal Shock	-55° to 100°C, 100 cycles	MIL-STD-202, Method 107, Condition A-3, except +100°C
Solder Reflow Heat	Sn-Pb Eutectic Process: 225°C peak Pb-Free Process, 245°C peak	J-STD-020, Table 4-1, 4-2 and 5-2, Figure 5-1
Solderability	10X Magnification	J-STD-002, Para 4.2.5, Test S, 95% Coverage
Vibration (High Frequency)	20g peak, 10-2000 Hz, 4 times in each of three axes (total 12)	MIL-STD-202, Method 204, Condition D
Mechanical Shock	50g, 11 ms, 1/2-sine, 18 shocks: 3 each direction, each of 3 axes	MIL-STD-202, Method 213, Condition A