

Surface Mount Bandpass Filter

BPF-F1250+

50Ω 1050 to 1450 MHz

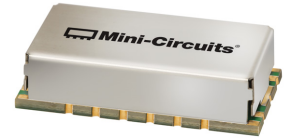

Generic photo used for illustration purposes only
CASE STYLE: HP1156

The Big Deal

- Broad bandwidth
- Low passband IL and VSWR
- Fast roll-off skirts
- Shielded package

Product Overview

BPF-F1250+ is a 50Ω bandpass filter in a shielded package fabricated using SMT technology. This filter offers low insertion loss in the passband for use in L-band application.

Key Features

Feature	Advantages
Low insertion loss	This filter incorporates high Q components that enables low loss in the passband.
Low VSWR	This filter offers good passband return loss that enables perfect matching in the passband.
Fast roll-off skirts	This filter designed using transmission zeros that enables fast roll-off skirts near the passband edges.
Shielded package	Reduced interference from the surrounding components.

Notes

- A. Performance and quality attributes and conditions not expressly stated in this specification document are intended to be excluded and do not form a part of this specification document.
B. Electrical specifications and performance data contained in this specification document are based on Mini-Circuit's applicable established test performance criteria and measurement instructions.
C. The parts covered by this specification document are subject to Mini-Circuits standard limited warranty and terms and conditions (collectively, "Standard Terms"); Purchasers of this part are entitled to the rights and benefits contained therein. For a full statement of the Standard Terms and the exclusive rights and remedies thereunder, please visit Mini-Circuits' website at www.minicircuits.com/MCLStore/terms.jsp



Surface Mount Bandpass Filter

BPF-F1250+

50Ω 1050 to 1450 MHz

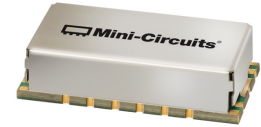

Generic photo used for illustration purposes only
CASE STYLE: HP1156

Features

- Broad bandwidth
- Low passband IL & VSWR
- Fast roll-off skirts
- Shielded package

Applications

- Broad band
- L-band
- Test and Measurements

Electrical Specifications at 25°C

Parameter	F#	Frequency (MHz)	Min.	Typ.	Max.	Unit
Pass Band	Center Frequency	—	—	1250	—	MHz
	Insertion Loss	F1-F2	1050-1450	0.8	2.0	dB
	VSWR	F1-F2	1050-1450	1.35	1.65	:1
Stop Band, Lower	Insertion Loss	DC-F3	DC-960	20	—	dB
	VSWR	DC-F3	DC-960	10	—	:1
Stop Band, Upper	Insertion Loss	F4-F5	1640-2500	20	30	dB
	VSWR	F4-F5	1640-2500	10	—	:1

Maximum Ratings

Operating Temperature	-40°C to 85°C
Storage Temperature	-55°C to 100°C
RF Power Input	1.5 W

Permanent damage may occur if any of these limits are exceeded.

Functional Schematic

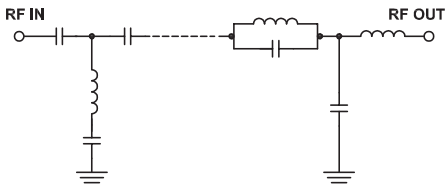

Typical Frequency Response

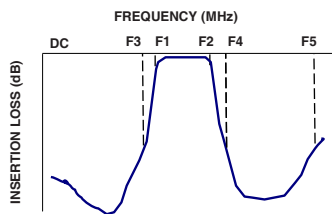

Typical Performance Data at 25°C

Frequency (MHz)	Insertion Loss (dB)	VSWR (:1)	Frequency (MHz)	Group Delay (nsec)
1	74.41	438.05	1050	3.51
50	40.11	795.34	1070	2.92
150	30.53	847.74	1090	2.53
430	23.10	181.77	1110	2.26
760	51.07	75.57	1130	2.08
840	34.43	59.77	1150	1.95
960	30.51	17.75	1170	1.86
965	22.78	13.99	1190	1.79
975	10.77	6.13	1210	1.74
990	3.00	1.77	1230	1.71
1050	0.86	1.15	1250	1.70
1250	0.56	1.12	1270	1.69
1450	0.94	1.10	1300	1.71
1510	3.04	2.72	1330	1.77
1550	9.29	8.90	1350	1.82
1600	21.01	20.45	1380	1.93
1630	30.15	25.31	1400	2.04
1640	34.10	26.67	1410	2.12
2000	42.29	51.17	1430	2.33
2500	38.50	40.27	1450	2.65

+RoHS Compliant

The +Suffix identifies RoHS Compliance. See our web site for RoHS Compliance methodologies and qualifications

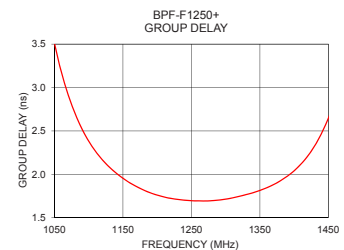
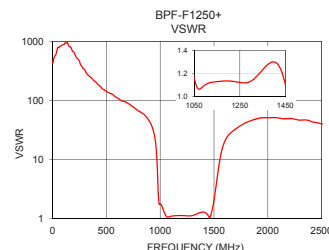
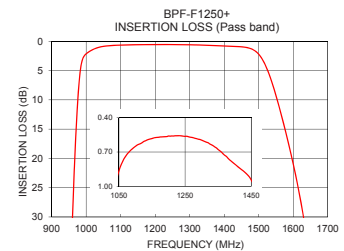
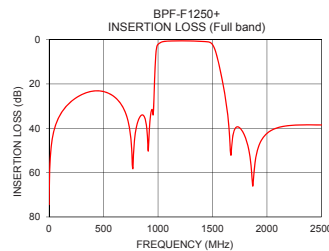

Notes

- Performance and quality attributes and conditions not expressly stated in this specification document are intended to be excluded and do not form a part of this specification document.
- Electrical specifications and performance data contained in this specification document are based on Mini-Circuit's applicable established test performance criteria and measurement instructions.
- The parts covered by this specification document are subject to Mini-Circuits standard limited warranty and terms and conditions (collectively, "Standard Terms"); Purchasers of this part are entitled to the rights and benefits contained therein. For a full statement of the Standard Terms and the exclusive rights and remedies thereunder, please visit Mini-Circuits' website at www.minicircuits.com/MCLStore/terms.jsp



www.minicircuits.com P.O. Box 350166, Brooklyn, NY 11235-0003 (718) 934-4500 sales@minicircuits.com

REV. A
M174392
BPF-F1250+
EDU2289_2
URJ
190909
Page 2 of 3

Pad Connections

INPUT	18
OUTPUT	9
GROUND	1,3,4,5,6,7,8,10,12,13,14,15,16,17
NO CONNECTION	2,11

Demo Board MCL P/N: TB-695+
Suggested PCB Layout (PL-418)

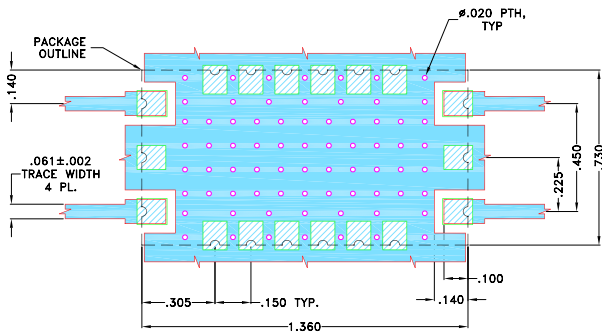

- NOTES:**
- TRACE WIDTH IS SHOWN FOR OAK-602, WITH DIELECTRIC THICKNESS .022 ± .0015". COPPER: 1/2 Oz. EACH SIDE. FOR OTHER MATERIALS TRACE WIDTH MAY NEED TO BE MODIFIED.
 - BOTTOM SIDE OF THE PCB IS CONTINUOUS GROUND PLANE.
- DENOTES PCB COPPER LAYOUT WITH SMOBC (SOLDER MASK OVER BARE COPPER)
 DENOTES COPPER LAND PATTERN FREE OF SOLDERMASK

Outline Drawing

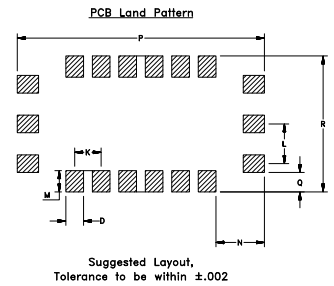
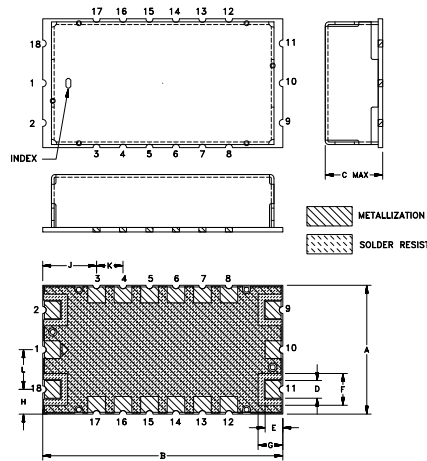

Outline Dimensions (inch/mm)

A	B	C	D	E	F	G	H	J
.730	1.360	.350	.100	.100	.180	.140	.140	.305
18.54	34.54	8.89	2.54	2.54	4.57	3.56	3.56	7.75
K	L	M	N	P	Q	R	Wt.	
.150	.225	.120	.275	1.400	.110	.770	grams	
3.81	5.72	3.05	6.99	35.56	2.79	19.56	6.0	

Note: Please refer to case style drawing for details

Notes

- Performance and quality attributes and conditions not expressly stated in this specification document are intended to be excluded and do not form a part of this specification document.
- Electrical specifications and performance data contained in this specification document are based on Mini-Circuit's applicable established test performance criteria and measurement instructions.
- The parts covered by this specification document are subject to Mini-Circuits standard limited warranty and terms and conditions (collectively, "Standard Terms"); Purchasers of this part are entitled to the rights and benefits contained therein. For a full statement of the Standard Terms and the exclusive rights and remedies thereunder, please visit Mini-Circuits' website at www.minicircuits.com/MCLStore/terms.jsp

Typical Performance Data

FREQ. (MHz)	INSERTION LOSS			INPUT RETURN LOSS			OUTPUT RETURN LOSS		
	(dB)			(dB)			(dB)		
	@-40°C	@+25°C	@+85°C	@-40°C	@+25°C	@+85°C	@-40°C	@+25°C	@+85°C
1	73.64	73.78	74.12	0.05	0.05	0.05	0.06	0.06	0.06
60	38.43	38.46	38.47	0.04	0.04	0.04	0.05	0.06	0.06
100	33.99	33.98	33.96	0.04	0.04	0.04	0.06	0.08	0.08
230	26.65	26.73	26.75	0.04	0.06	0.06	0.12	0.15	0.17
310	24.17	24.37	24.49	0.06	0.08	0.09	0.17	0.22	0.24
440	22.65	22.82	22.99	0.09	0.11	0.12	0.25	0.31	0.34
500	22.97	23.14	23.30	0.10	0.13	0.14	0.26	0.32	0.36
550	23.79	23.98	24.15	0.12	0.15	0.16	0.25	0.32	0.36
700	31.99	32.34	32.65	0.16	0.21	0.22	0.22	0.29	0.34
750	42.66	43.54	44.42	0.18	0.23	0.26	0.22	0.31	0.36
800	39.89	39.52	39.18	0.22	0.27	0.30	0.25	0.35	0.41
850	33.50	33.64	33.74	0.26	0.32	0.35	0.32	0.45	0.53
900	39.32	40.86	42.36	0.34	0.41	0.46	0.46	0.64	0.75
950	31.24	31.94	32.47	0.61	0.78	0.92	0.87	1.18	1.41
960	35.10	32.25	28.21	0.79	1.05	1.30	1.10	1.52	1.87
965	30.37	24.69	21.10	0.96	1.33	1.70	1.30	1.83	2.33
970	21.87	17.76	14.98	1.26	1.85	2.48	1.63	2.40	3.19
975	15.09	12.04	9.97	1.89	2.95	4.13	2.30	3.57	4.95
980	9.58	7.54	6.30	3.32	5.36	7.43	3.81	6.10	8.52
985	5.54	4.63	4.18	6.65	10.03	12.29	7.30	11.11	14.05
990	3.29	3.20	3.17	12.90	14.58	13.64	14.16	16.17	15.26
995	2.37	2.60	2.70	15.63	13.08	11.91	17.03	14.08	12.99
1000	2.02	2.30	2.42	12.71	11.33	10.87	13.44	12.12	11.81
1020	1.38	1.57	1.65	11.62	11.74	12.16	12.24	12.57	13.19
1050	0.78	0.94	1.04	20.62	20.93	21.57	21.62	22.37	23.59
1100	0.57	0.72	0.81	21.66	21.33	21.62	22.24	21.95	22.39
1150	0.57	0.71	0.79	17.09	16.92	17.31	17.41	17.28	17.72
1200	0.55	0.69	0.77	16.51	16.49	16.85	16.44	16.49	16.87
1250	0.52	0.66	0.74	18.09	18.37	18.75	17.77	18.11	18.46
1300	0.49	0.64	0.73	23.52	24.80	25.49	22.86	23.89	24.14
1350	0.52	0.68	0.79	35.73	30.72	29.65	33.05	28.66	27.11
1400	0.64	0.82	0.94	19.95	19.08	18.98	19.53	18.64	18.49
1450	0.80	1.02	1.17	18.70	18.82	19.33	17.40	17.09	17.07
1500	1.40	1.81	2.15	14.89	13.83	12.79	12.26	11.03	10.05
1510	1.85	2.36	2.80	10.97	10.18	9.40	9.30	8.36	7.58
1520	2.58	3.20	3.75	7.93	7.38	6.84	6.77	6.11	5.54
1530	3.64	4.38	5.04	5.64	5.31	4.95	4.77	4.35	3.97
1540	5.06	5.90	6.65	3.99	3.82	3.61	3.29	3.06	2.83
1550	6.79	7.70	8.52	2.85	2.79	2.69	2.26	2.17	2.05
1560	8.78	9.72	10.59	2.09	2.11	2.07	1.59	1.58	1.53
1570	10.96	11.92	12.84	1.59	1.65	1.66	1.15	1.19	1.20
1580	13.38	14.36	15.32	1.27	1.36	1.38	0.88	0.95	0.96
1585	14.62	15.59	16.54	1.13	1.23	1.26	0.76	0.84	0.86
1600	18.38	19.36	20.36	0.86	0.97	1.02	0.53	0.63	0.67
1605	19.71	20.71	21.73	0.80	0.91	0.96	0.48	0.58	0.63
1610	21.09	22.12	23.16	0.75	0.86	0.92	0.44	0.54	0.59
1615	22.54	23.58	24.64	0.71	0.82	0.87	0.41	0.51	0.56
1620	24.04	25.08	26.18	0.67	0.78	0.84	0.38	0.48	0.53
1625	25.60	26.66	27.80	0.64	0.75	0.81	0.35	0.45	0.51
1630	27.24	28.33	29.51	0.61	0.72	0.78	0.33	0.43	0.49
1635	28.98	30.11	31.37	0.58	0.69	0.75	0.31	0.41	0.47
1640	30.85	32.05	33.41	0.56	0.67	0.73	0.29	0.40	0.45
1650	35.33	36.73	38.37	0.52	0.63	0.69	0.26	0.37	0.43
1800	40.83	41.16	41.60	0.30	0.43	0.51	0.11	0.21	0.26
1900	66.79	67.23	67.21	0.26	0.41	0.50	0.08	0.17	0.23
2000	44.83	44.88	44.91	0.26	0.42	0.52	0.07	0.16	0.21
2100	41.16	41.22	41.25	0.27	0.43	0.54	0.07	0.16	0.21
2200	39.99	40.01	39.97	0.28	0.45	0.56	0.07	0.16	0.21
2400	39.99	39.97	39.80	0.29	0.47	0.60	0.08	0.17	0.22
2500	40.43	40.31	40.16	0.30	0.50	0.63	0.08	0.17	0.22

Typical Performance Data

FREQ. (MHz)	GROUP DELAY		
	(nsec)		
	@-40°C	@+25°C	@+85°C
1050	3.65	3.53	3.44
1055	3.46	3.36	3.27
1060	3.30	3.20	3.13
1065	3.15	3.06	3.00
1070	3.01	2.94	2.88
1075	2.89	2.82	2.77
1080	2.78	2.72	2.67
1085	2.68	2.62	2.58
1090	2.58	2.53	2.49
1095	2.50	2.45	2.42
1100	2.42	2.38	2.35
1105	2.35	2.31	2.28
1110	2.29	2.25	2.23
1115	2.23	2.20	2.17
1120	2.18	2.15	2.13
1125	2.13	2.10	2.08
1130	2.09	2.06	2.04
1135	2.04	2.02	2.00
1140	2.01	1.98	1.97
1145	1.97	1.95	1.93
1150	1.94	1.92	1.91
1155	1.91	1.89	1.88
1160	1.88	1.86	1.85
1165	1.86	1.84	1.83
1170	1.84	1.82	1.81
1175	1.81	1.80	1.79
1180	1.80	1.78	1.77
1185	1.78	1.76	1.76
1190	1.76	1.75	1.74
1195	1.75	1.73	1.73
1200	1.73	1.72	1.71
1205	1.72	1.71	1.70
1210	1.71	1.70	1.69
1215	1.70	1.69	1.69
1220	1.69	1.68	1.68
1225	1.68	1.68	1.67
1230	1.68	1.67	1.67
1235	1.67	1.67	1.66
1240	1.67	1.66	1.66
1245	1.67	1.66	1.66
1250	1.66	1.66	1.66
1255	1.66	1.66	1.66
1260	1.66	1.66	1.66
1265	1.66	1.66	1.66
1270	1.67	1.66	1.66
1275	1.67	1.67	1.67
1280	1.67	1.67	1.67
1285	1.67	1.67	1.67
1290	1.68	1.68	1.68
1295	1.68	1.68	1.68
1300	1.69	1.69	1.69
1310	1.70	1.70	1.70
1320	1.72	1.72	1.73
1330	1.74	1.74	1.75
1340	1.76	1.77	1.77
1350	1.79	1.79	1.80
1400	1.97	1.98	2.00
1410	2.03	2.04	2.07
1420	2.10	2.12	2.15
1450	2.42	2.46	2.51

Typical Performance Curves

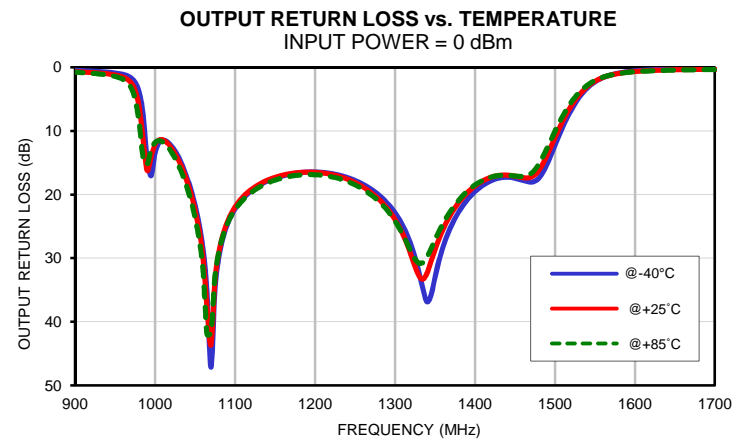
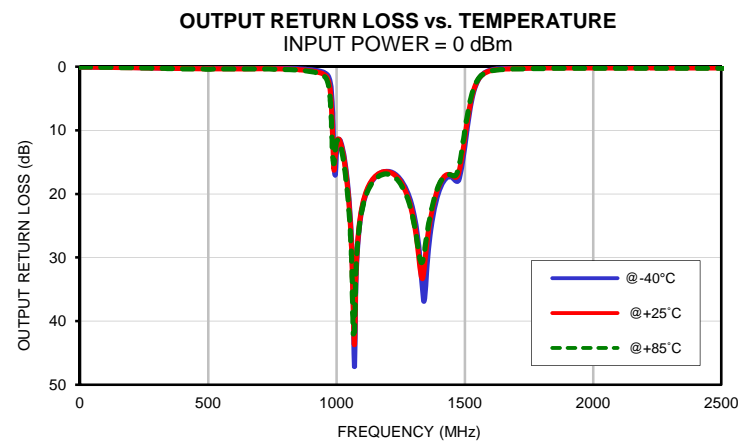
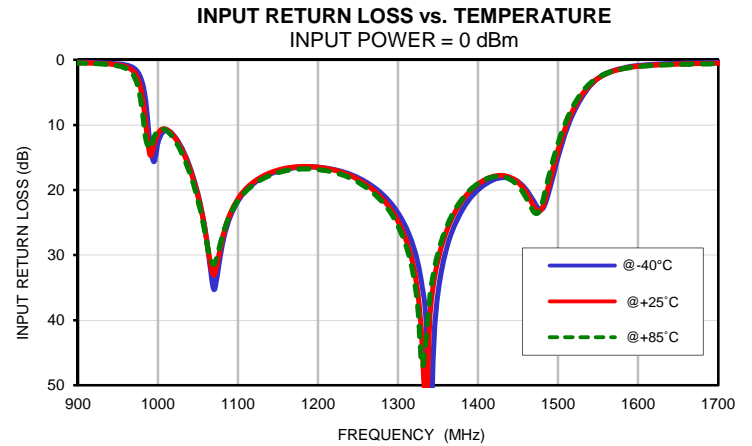
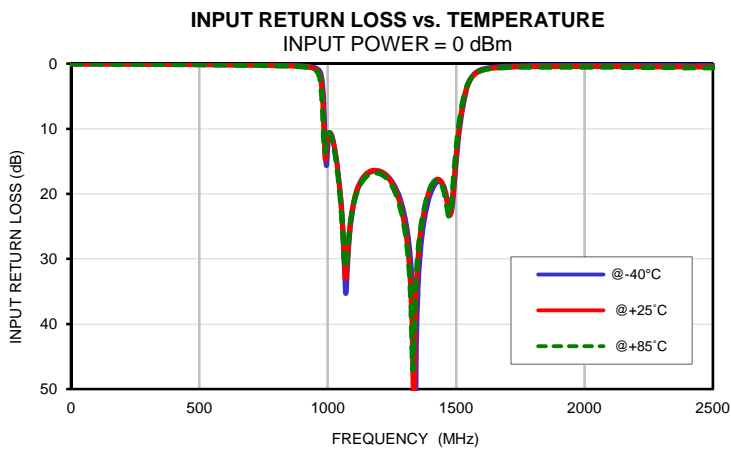
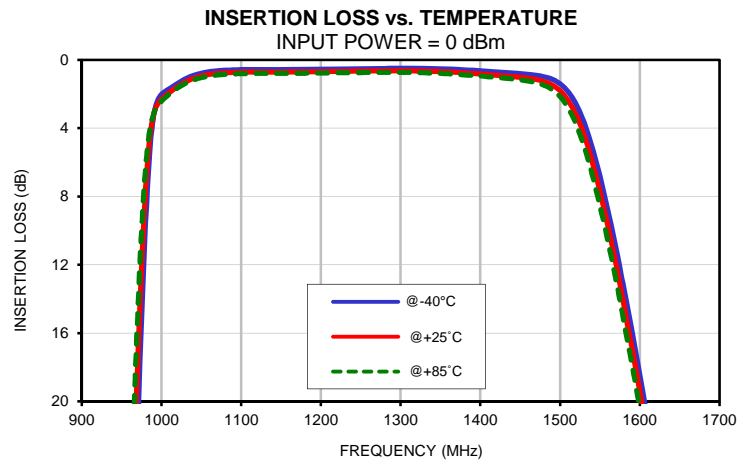
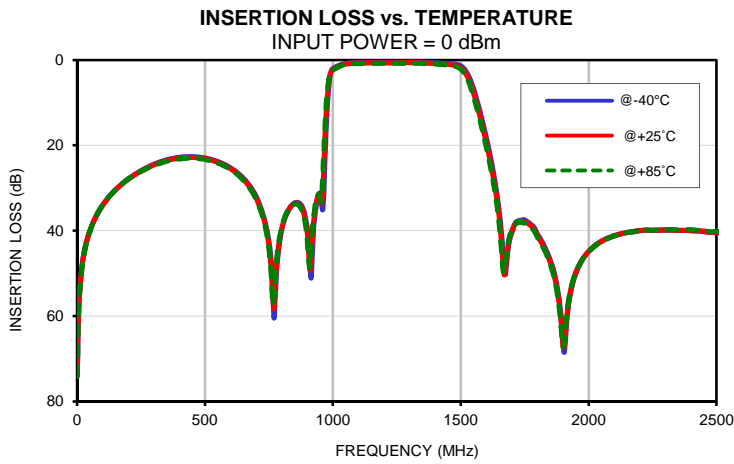

Typical Performance Curves

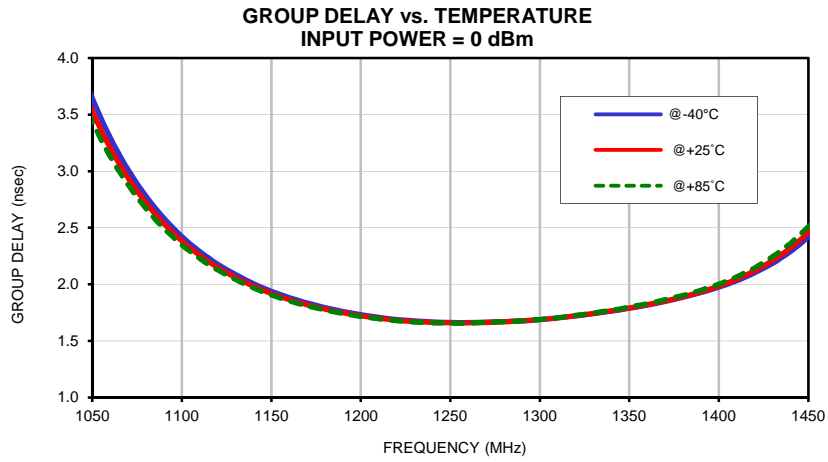

Tape & Reel Packaging TR-F89

DEVICE ORIENTATION IN T&R

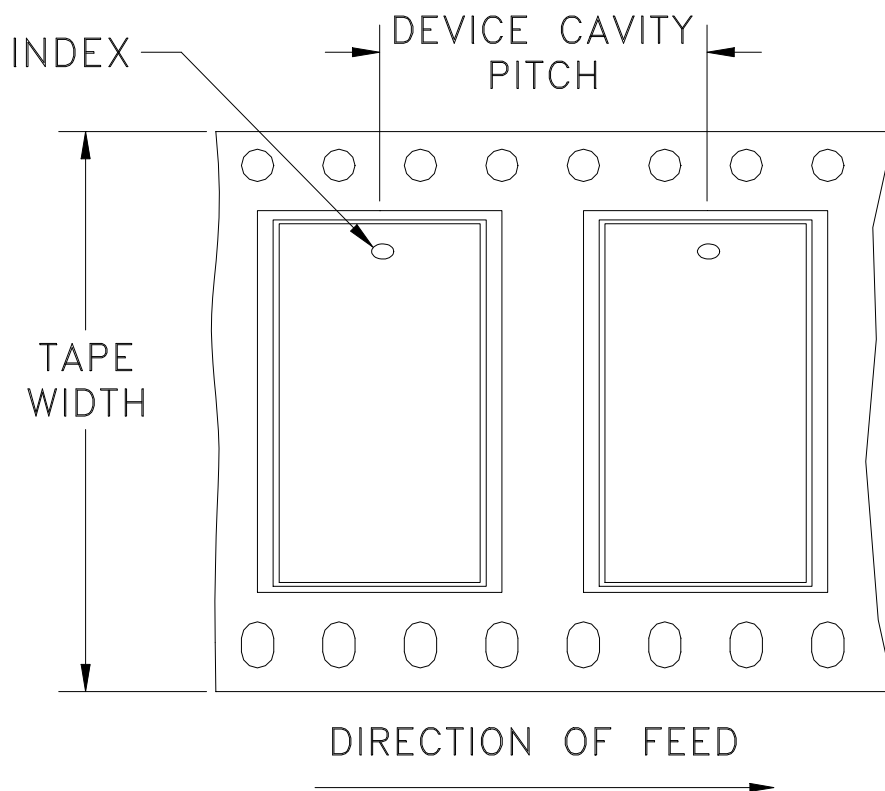

Tape Width, mm	Device Cavity Pitch, mm	Reel Size, inches	Devices per Reel
56	32	13	100

Mini-Circuits carrier tape materials provide protection from ESD (Electro-Static Discharge) during handling and transportation. Tapes are static dissipative and comply with industry standards EIA-481/EIA-541.

Go to: www.minicircuits.com/pages/pdfs/tape.pdf



INTERNET <http://www.minicircuits.com>

P.O. Box 350166, Brooklyn, New York 11235-0003 (718) 934-4500 Fax (718) 332-4661

Distribution Centers NORTH AMERICA 800-654-7949 • 417-335-5935 • Fax 417-335-5945 • EUROPE 44-1252-832600 • Fax 44-1252-837010

Mini-Circuits ISO 9001 & ISO 14001 Certified

THIRD ANGLE PROJECTION

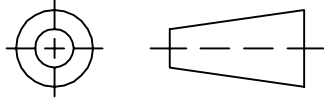

REVISIONS

REV OR	ECN No.	DESCRIPTION	DATE	DR	AUTH
	M145648	NEW RELEASE	MAR 14	DDR	MD

**SUGGESTED MOUNTING CONFIGURATION FOR
HP1156 CASE STYLE "18FL01" PIN CODE**

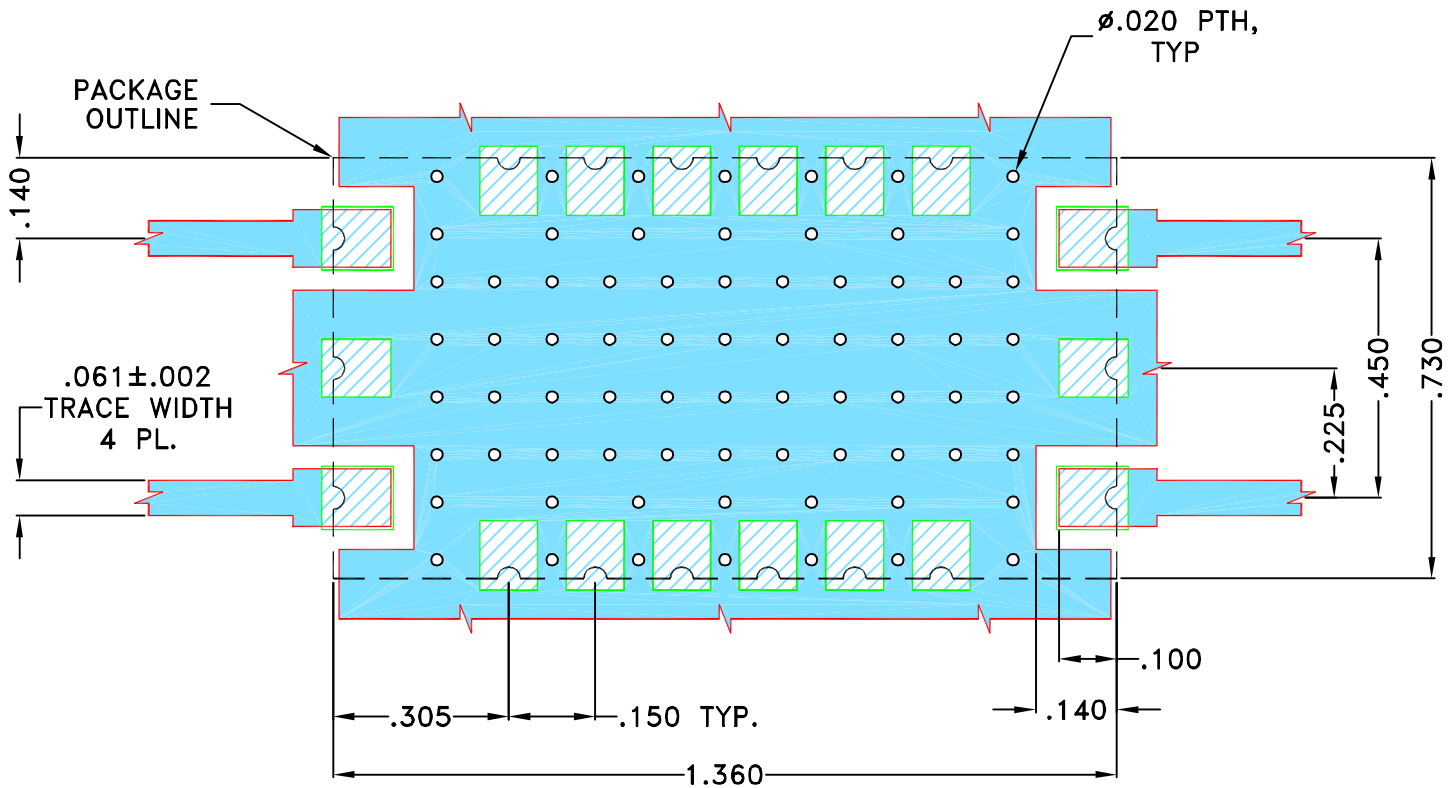

NOTES:

- TRACE WIDTH IS SHOWN FOR OAK-602, WITH DIELECTRIC THICKNESS $.022 \pm .0015$ ". COPPER: 1/2 Oz. EACH SIDE.
FOR OTHER MATERIALS TRACE WIDTH MAY NEED TO BE MODIFIED.
- BOTTOM SIDE OF THE PCB IS CONTINUOUS GROUND PLANE.



SOLID BLUE DENOTES PCB COPPER LAYOUT WITH SMOBC
(SOLDER MASK OVER BARE COPPER)
HATCHED BLUE DENOTES COPPER LAND PATTERN FREE OF SOLDERMASK

UNLESS OTHERWISE SPECIFIED	INITIALS	DATE
DIMENSIONS ARE IN INCHES TOLERANCES ON: 2 PL DECIMALS ± 3 PL DECIMALS ± .005" ANGLES ± FRACTIONS ±	DRAWN	DDR 14 MAR 14
	CHECKED	MD 14 MAR 14
	APPROVED	MD 14 MAR 14



Mini-Circuits® 13 Neptune Avenue
Brooklyn NY 11235

**PL, 18FL01, HP1156, BPF
TB-695+, 50 Ohm**

Mini-Circuits®
THIS DOCUMENT AND ITS CONTENTS ARE THE PROPERTY OF MINI-CIRCUITS. EXCEPT FOR USE EXPRESSLY GRANTED, IN WRITING, TO ITS VENDORS, VENDEE AND THE UNITED STATES GOVERNMENT, MINI-CIRCUITS RESERVES ALL PROPRIETARY DESIGN, USE, MANUFACTURING AND REPRODUCTION RIGHTS THERETO. THESE CONTENTS SHALL NOT BE USED, DUPLICATED OR DISCLOSED TO ANY OUTSIDE PARTY, IN WHOLE OR IN PART, WITHOUT WRITTEN PERMISSION OF MINI-CIRCUITS.

SIZE A	CODE IDENT 15542	DRAWING NO: 98-PL-418	REV: OR
FILE: 98PL418	SCALE: 3:1	SHEET: 1 OF 1	

Evaluation Board and Circuit

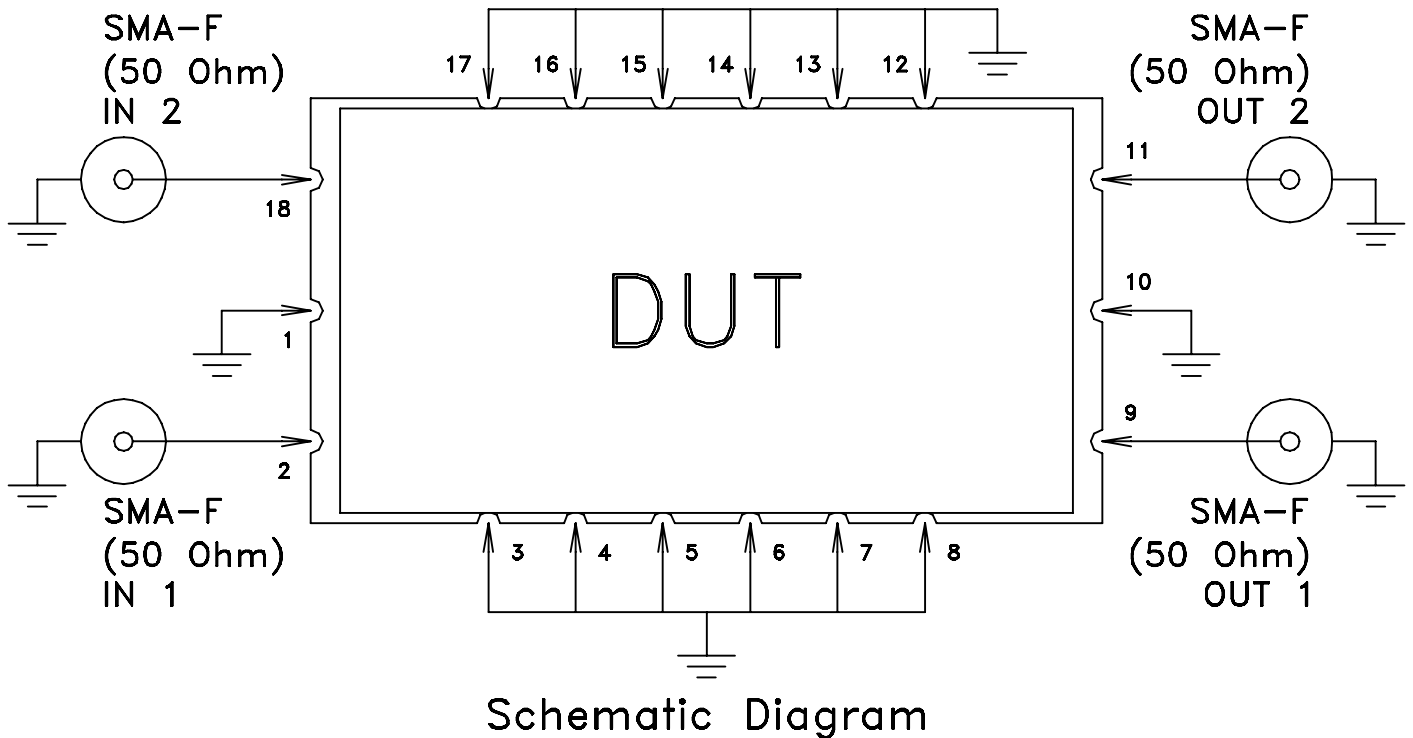
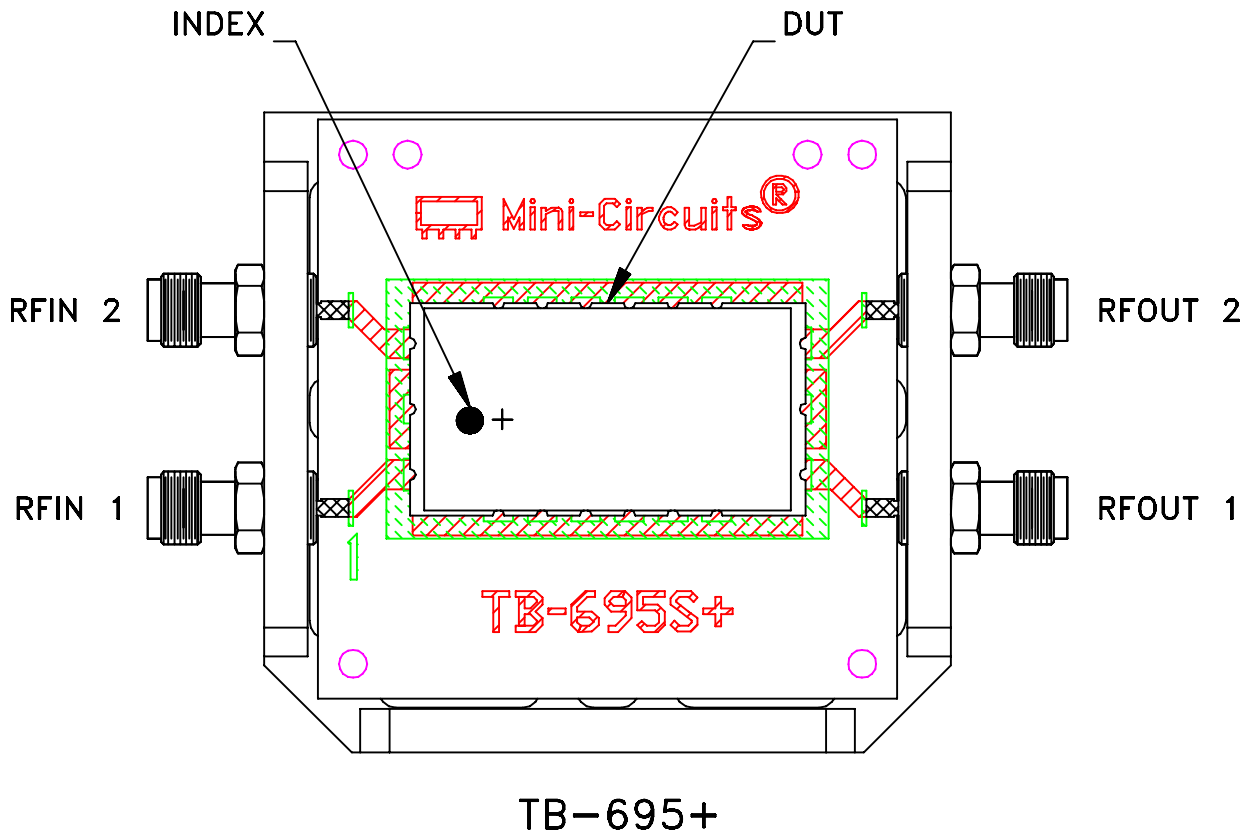

Notes:

1. 50 Ohm SMA Female connectors.
2. PCB Material: OAK-602 OR Equivalent
Dielectric Constant=2.50±.04, Thickness=.022 Inch.

 Mini-Circuits®

All Mini-Circuits products are manufactured under exacting quality assurance and control standards, and are capable of meeting published specifications after being subjected to any or all of the following physical and environmental test.

Specification	Test/Inspection Condition	Reference/Spec
Operating Temperature	-40° to 85° C Ambient Environment	Individual Model Data Sheet
Storage Temperature	-65° to 150° C Ambient Environment	Individual Model Data Sheet
Autoclave	15 psig, 100% RH, 121°C, 96 hours	JESD22-A102-C, Condition C
Temperature Cycling	-65° to 150°C, 100 cycles	JESD22-A104
Temperature Humidity	85°C/ 85% RH, 168 hours	JESD22-113
Solder Reflow Heat	Sn-Pb Eutetic Process: 240°C peak Pb-Free Process: 260°C peak	J-STD-020, Table 4-1, 4-2 and 5-2; Figure 5-1
Moisture Sensitivity: Level 1	Bake at 125°C for 24 hours Soak at 85°C/85% RH for 168 hours, Reflow 3 cycles at 240°C peak (Non-RoHS) or 260°C (RoHS)	J-STD-020
Solderability	10X magnification, 95% coverage	JESD22-B102, Method 1: Dip and Look Test
Mechanical Shock	50g, 11 ms, 1/2-sine, 18 shocks: 3 each direction, each of 3 axes	MIL-STD-202, Method 213, Condition A
Vibration (High Frequency)	20g peak, 10-2000 Hz, 12 times in each of three perpendicular directions (total 36)	MIL-STD-202, Method 204, Condition D