

Bandpass Filter

BPF-B190+

50Ω 185 to 195 MHz

Maximum Ratings

Operating Temperature	-40°C to 85°C
Storage Temperature	-55°C to 100°C
RF Power Input	0.5W Max.

Permanent damage may occur if any of these limits are exceeded.

Pin Connections

INPUT	1
OUTPUT	2
GROUND	3, 4, 5, 6

Outline Drawing

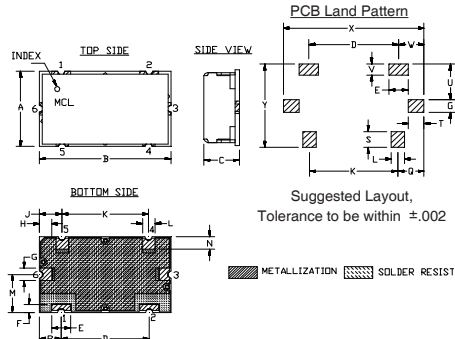

Outline Dimensions (inch/mm)

A	B	C	D	E	F	G	H	J	K	L	M
.472"	.826"	.220"	.551"	.118"	.047"	.078"	.076"	.142"	.543"	.078"	.236"
11.99	20.98	5.59	14.00	3.00	1.19	1.98	1.92	3.61	13.79	1.98	5.99
N	P	Q	S	T	U	V	W	X	Y		wt
.079"	.138"	.162"	.098"	.096"	.217"	.067"	.157"	.866"	.512"		grams
2.01	3.51	4.11	2.49	2.44	5.51	1.70	3.99	22.00	13.00		6.0

Note: Please refer to case style drawing for details

Demo Board MCL P/N: TB-400+ Suggested PCB Layout (PL-247)

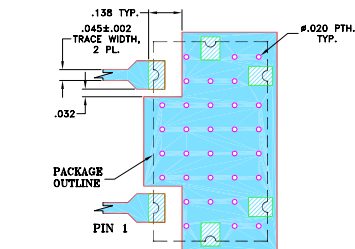

Features

- Excellent rejection
- Flat Group Delay @ Passband
- Good VSWR, 1.15:1 typ. @ Passband

Applications

- Receivers / Transmitters
- Radio microphones
- Military communication



Generic photo used for illustration purposes only
CASE STYLE: HZ1198

+RoHS Compliant

The +Suffix identifies RoHS Compliance. See our web site for RoHS Compliance methodologies and qualifications

Bandpass Filter Electrical Specifications (T_{AMB} = 25°C)

CENTER FREQ. (MHz)	PASSBAND (MHz) (Loss < 4.7dB) F1 - F2	STOPBANDS (MHz)				VSWR (:1)	
		Loss > 20dB F3	Loss > 40dB F4	Loss > 40dB F5	Loss > 40dB F6	Passband Max.	Stopband Typ.
190	185 - 195	170	212	155	230 - 2000	1.5	30

Typical Frequency Response

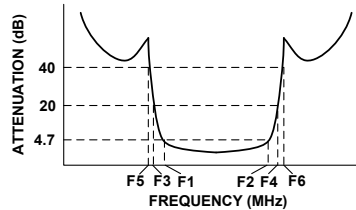

Functional Schematic

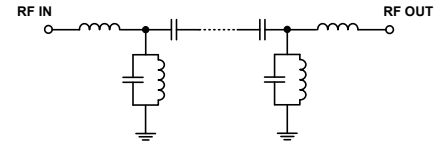

Typical Performance Data at 25°C

Frequency (MHz)	Insertion Loss (dB)		Return Loss (dB)	Frequency (MHz)	Group Delay (nsec)
	\bar{x}	σ			
1.0	83.66	0.86	0.42	183.0	66.14
155.0	54.14	0.72	0.18	184.0	60.77
170.0	32.66	0.88	0.55	185.0	56.86
175.0	22.01	1.08	1.21	186.0	52.82
179.0	11.55	1.21	3.47	187.0	50.61
182.0	5.48	0.57	11.84	188.0	49.31
185.0	3.75	0.09	21.84	188.5	48.83
190.0	3.37	0.03	24.85	189.0	48.56
195.0	3.85	0.13	17.06	189.5	48.12
198.0	5.70	0.73	14.31	190.0	47.85
201.0	11.44	1.32	4.25	190.5	47.87
205.0	20.72	1.15	1.71	191.0	47.74
212.0	33.12	0.82	0.80	192.0	47.53
230.0	52.25	0.54	0.34	193.0	49.08
500.0	81.70	0.63	0.10	194.0	50.24
700.0	78.33	0.57	0.14	195.0	53.06
1000.0	72.87	0.33	0.18	196.0	56.55
2000.0	57.07	0.29	0.26	197.0	60.98

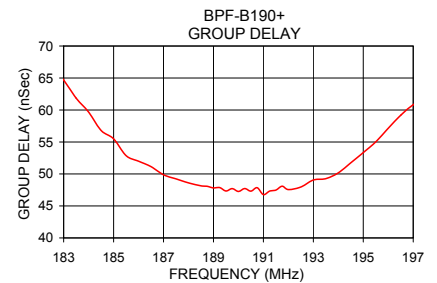
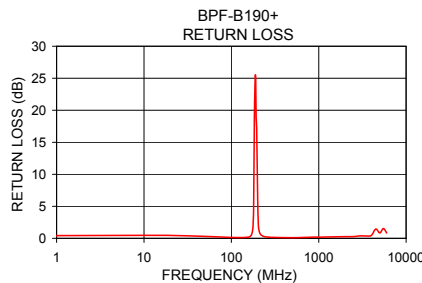
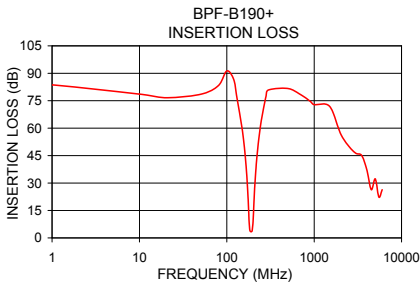

Notes

- Performance and quality attributes and conditions not expressly stated in this specification document are intended to be excluded and do not form a part of this specification document.
- Electrical specifications and performance data contained in this specification document are based on Mini-Circuit's applicable established test performance criteria and measurement instructions.
- The parts covered by this specification document are subject to Mini-Circuits standard limited warranty and terms and conditions (collectively, "Standard Terms"); Purchasers of this part are entitled to the rights and benefits contained therein. For a full statement of the Standard Terms and the exclusive rights and remedies thereunder, please visit Mini-Circuits' website at www.minicircuits.com/MCLStore/terms.jsp



Surface Mount Band Pass Filter

BPF-B190+

Typical Performance Data

FREQ. (MHz)	INSERTION LOSS (dB)			INPUT RETURN LOSS (dB)			OUTPUT RETURNLOSS (dB)		
	@ -40° C	@ +25° C	@ +85° C	@ -40° C	@ +25° C	@ +85° C	@ -40° C	@ +25° C	@ +85° C
0.5	99.11	97.96	96.94	0.34	0.43	0.50	0.34	0.44	0.52
1	100.04	91.28	95.28	0.33	0.43	0.51	0.35	0.44	0.53
5	83.91	85.66	85.43	0.37	0.46	0.55	0.37	0.47	0.56
10	85.72	79.45	80.71	0.40	0.48	0.57	0.39	0.50	0.59
15	79.04	82.95	77.87	0.41	0.49	0.57	0.38	0.47	0.56
20	81.82	77.15	79.18	0.40	0.47	0.54	0.39	0.46	0.54
30	77.55	77.54	76.73	0.35	0.41	0.46	0.35	0.40	0.46
40	80.09	77.58	77.61	0.31	0.35	0.40	0.30	0.35	0.38
50	82.39	77.40	77.07	0.26	0.30	0.33	0.26	0.30	0.32
60	79.63	78.54	78.94	0.22	0.26	0.28	0.22	0.25	0.27
70	85.32	80.20	82.93	0.19	0.23	0.25	0.18	0.21	0.24
80	83.14	89.83	86.70	0.17	0.20	0.22	0.14	0.18	0.21
90	82.53	90.00	83.20	0.14	0.18	0.20	0.12	0.16	0.18
100	82.76	82.28	88.41	0.13	0.17	0.18	0.10	0.14	0.17
110	84.46	88.23	96.05	0.12	0.15	0.16	0.09	0.13	0.15
120	89.32	95.27	87.55	0.10	0.15	0.16	0.07	0.12	0.14
130	81.20	80.65	82.07	0.11	0.15	0.17	0.08	0.13	0.14
140	70.92	70.66	70.29	0.11	0.17	0.18	0.08	0.13	0.15
150	61.09	60.69	60.83	0.13	0.19	0.21	0.10	0.15	0.20
155	55.93	55.67	55.38	0.16	0.22	0.25	0.13	0.19	0.22
160	50.08	49.65	49.10	0.20	0.28	0.31	0.17	0.25	0.29
170	34.70	34.07	33.36	0.43	0.58	0.67	0.45	0.60	0.71
180	11.23	10.62	9.97	3.30	4.32	5.47	3.69	4.89	6.20
185	3.58	4.05	4.36	24.79	23.62	22.28	35.24	30.85	28.58
190	2.97	3.50	3.90	23.84	24.87	26.67	30.75	28.50	26.92
195	3.23	3.89	4.45	23.82	24.12	25.24	21.31	20.72	20.52
200	6.63	8.32	9.89	8.56	7.52	6.64	7.24	6.31	5.56
210	27.98	29.11	30.15	1.01	1.14	1.19	0.87	0.99	1.05
212	31.20	32.23	33.19	0.83	0.96	1.02	0.73	0.84	0.90
220	41.58	42.34	43.05	0.49	0.60	0.64	0.43	0.52	0.57
230	50.97	51.50	52.16	0.32	0.42	0.45	0.27	0.36	0.39
240	58.13	58.72	59.10	0.25	0.34	0.36	0.20	0.28	0.30
250	63.76	64.11	65.20	0.21	0.29	0.32	0.16	0.23	0.27
260	67.85	69.26	70.95	0.18	0.28	0.29	0.12	0.20	0.22
270	73.30	73.07	74.33	0.17	0.26	0.28	0.11	0.18	0.20
280	76.62	74.80	77.82	0.14	0.24	0.27	0.09	0.16	0.19
290	80.43	79.31	79.86	0.14	0.24	0.26	0.08	0.15	0.18
300	85.95	86.75	77.96	0.13	0.23	0.25	0.07	0.15	0.17
400	86.39	84.92	87.70	0.11	0.23	0.27	0.04	0.12	0.15
500	81.84	97.09	89.81	0.12	0.26	0.32	0.04	0.13	0.17
600	106.76	89.39	88.42	0.16	0.31	0.37	0.04	0.15	0.19
700	80.59	81.60	95.20	0.18	0.35	0.42	0.06	0.18	0.23
800	87.67	94.98	87.73	0.21	0.39	0.48	0.08	0.21	0.27
900	78.89	86.35	84.62	0.24	0.43	0.52	0.09	0.23	0.28
1000	79.16	79.64	81.09	0.26	0.47	0.57	0.11	0.27	0.33
1100	73.38	76.04	73.21	0.30	0.49	0.62	0.13	0.28	0.36
1200	71.68	70.75	68.31	0.31	0.52	0.63	0.15	0.30	0.39
1300	67.15	68.63	68.27	0.32	0.53	0.66	0.16	0.32	0.40
1400	72.23	67.00	67.35	0.33	0.54	0.68	0.17	0.34	0.43
1500	70.76	67.41	65.87	0.35	0.55	0.68	0.18	0.36	0.44
1600	59.32	61.74	58.11	0.34	0.55	0.69	0.19	0.38	0.48
1700	61.61	56.74	59.83	0.30	0.54	0.67	0.16	0.34	0.43
1800	62.70	62.64	60.40	0.33	0.54	0.71	0.18	0.36	0.49
1900	51.42	55.22	51.98	0.34	0.56	0.72	0.20	0.39	0.50
2000	55.27	53.90	53.36	0.30	0.51	0.70	0.12	0.35	0.47

REV. X1

BPF-B190+

090301

Page 1 of 2



IF/RF MICROWAVE COMPONENTS • ISO 9001 ISO 14001 AS 9100 CERTIFIED • RoHS compliant

P.O. Box 350166, Brooklyn, New York 11235-0003 (718) 934-4500 Fax (718) 332-4661



The Design Engineers Search Engine finds the model you need, Instantly • For detailed performance specs & shopping online see



Surface Mount Band Pass Filter

BPF-B190+

Typical Performance Data

FREQ. (MHz)	GROUP DELAY (nsec)		
	@ -40° C	@ +25° C	@ +85° C
185.0	62.17	59.71	57.69
185.5	59.84	57.69	55.95
186.0	57.76	55.99	54.51
186.5	55.85	54.38	53.24
187.0	54.41	53.20	52.19
187.5	53.02	52.06	51.29
188.0	51.99	51.24	50.62
188.5	51.09	50.53	50.02
189.0	50.30	49.92	49.53
189.5	49.74	49.50	49.26
190.0	49.42	49.20	49.07
190.5	49.00	48.92	48.90
191.0	48.81	48.83	48.94
191.5	48.76	48.81	49.06
192.0	48.80	48.87	49.25
192.5	48.85	49.15	49.63
193.0	49.13	49.53	50.13
193.5	49.49	49.97	50.75
194.0	50.01	50.70	51.63
194.5	50.59	51.57	52.59
195.0	51.44	52.58	53.83

REV. X1
BPF-B190+
090301
Page 2 of 2



IF/RF MICROWAVE COMPONENTS • ISO 9001 ISO 14001 AS 9100 CERTIFIED RoHS compliant
P.O. Box 350166, Brooklyn, New York 11235-0003 (718) 934-4500 Fax (718) 332-4661



The Design Engineers Search Engine finds the model you need, Instantly • For detailed performance specs & shopping online see



Typical Performance Curves

INSERTION LOSS vs. TEMPERATURE

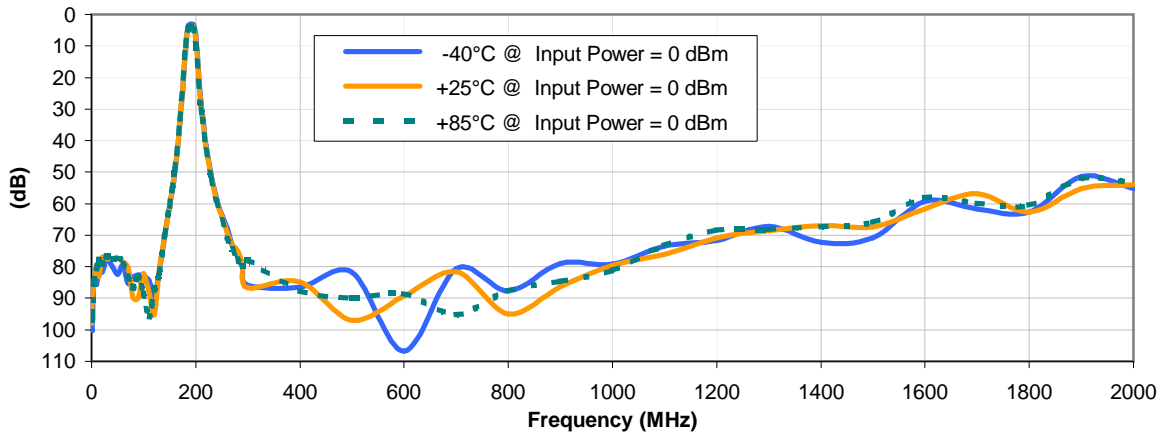

INPUT RETURN LOSS vs. TEMPERATURE

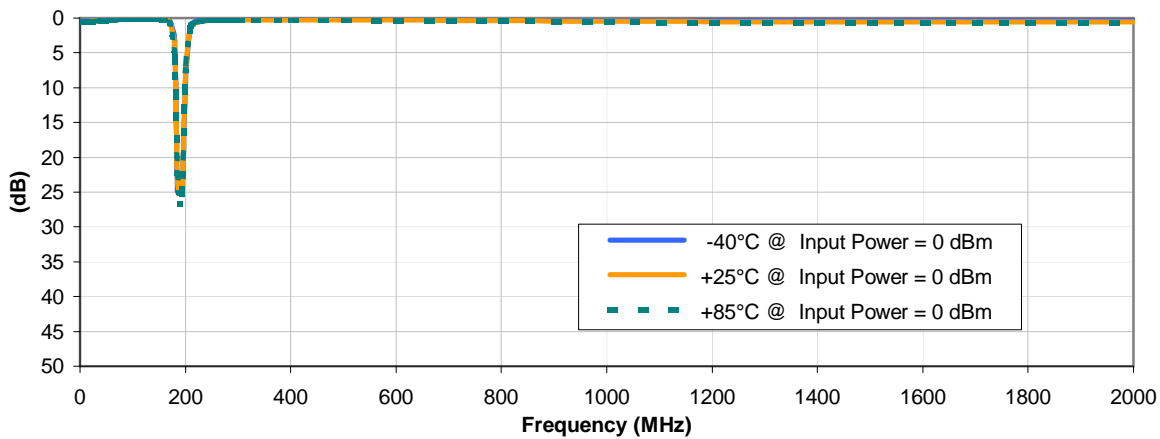

OUTPUT RETURN LOSS vs. TEMPERATURE

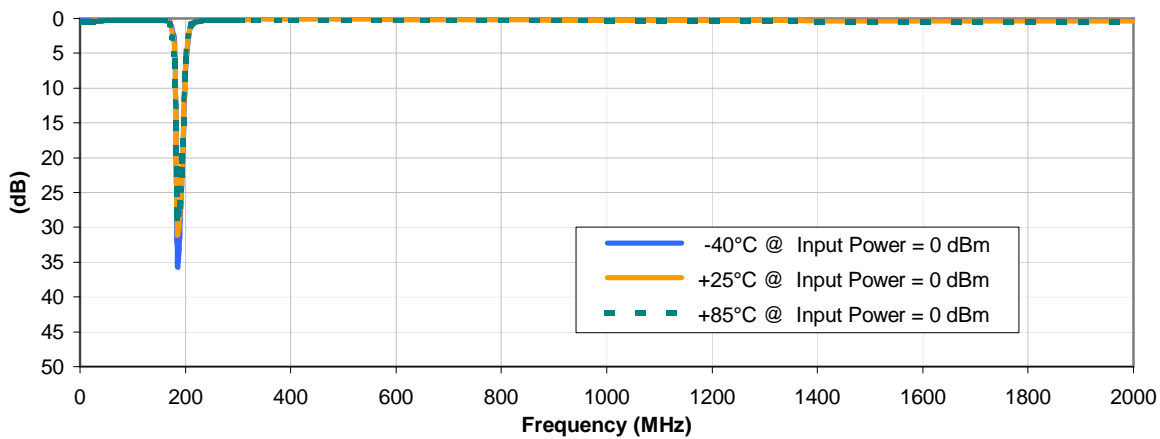

Typical Performance Curves

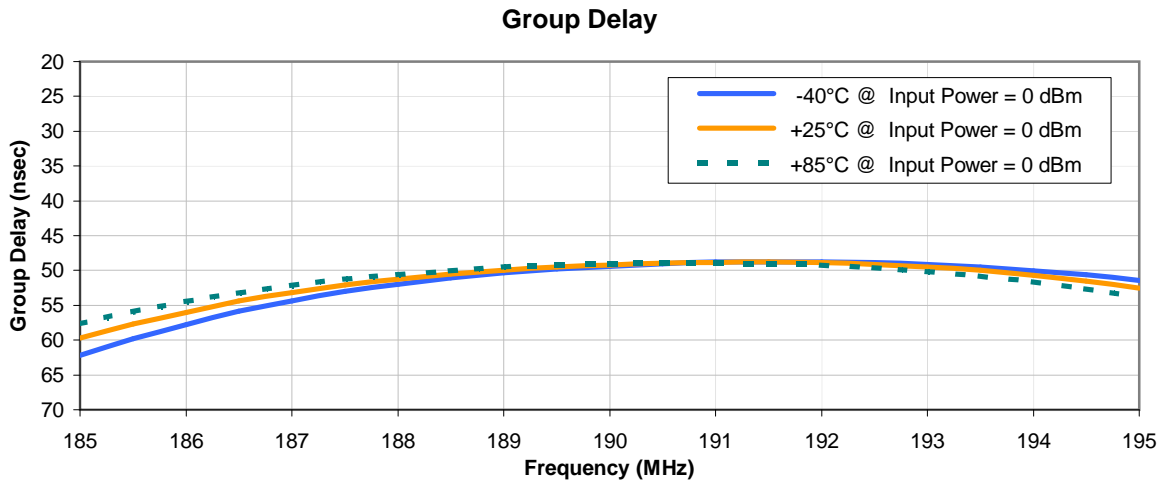

Case Style

HZ

Outline Dimensions

HZ1198

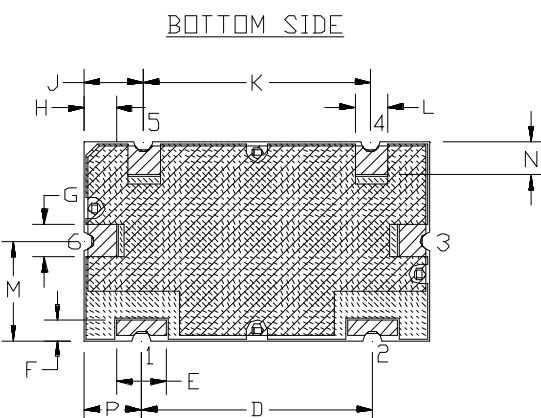
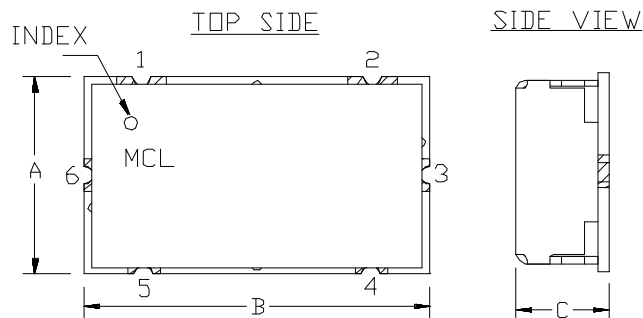

PCB Land Pattern

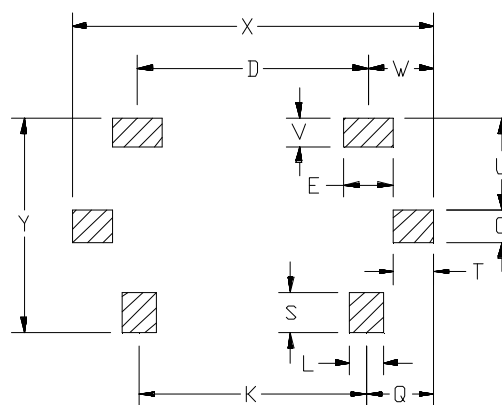

 METALLIZATION  SOLDER RESIST

Suggested Layout,
Tolerance to be within $\pm .002$

CASE #	A	B	C	D	E	F	G	H	J	K	L	M
HZ1198	.472" (11.99)	.826" (20.98)	.220" (5.59)	.551" (14.00)	.118" (3.00)	.047" (1.19)	.078" (1.98)	.076" (1.92)	.142" (3.61)	.543" (13.79)	.078" (1.98)	.236" (5.99)

CASE #	N	P	Q	S	T	U	V	W	X	Y	WT GRAMS	NOTES
HZ1198	.079" (2.01)	.138" (3.51)	.162" (4.11)	.098" (2.49)	.096" (2.44)	.217" (5.51)	.067" (1.70)	.157" (3.99)	.866" (22.00)	.512" (13.00)	6.0	A35

Dimensions are in inches (mm). Tolerances: 2PL. +/- .03; 3PL. +/- .015

Notes:

1. Case material: Nickel-Silver alloy.
2. Base: Printed wiring laminate.
3. Termination finish:

For RoHS Case Styles: 3-5 μ inch (.08-13 microns) Gold over 120-240 μ inch (3.05-6.10 microns) Nickel plate.
For RoHS-5 Case Styles: Tin-Lead plate.

 **Mini-Circuits**[®]
ISO 9001 ISO 14001 CERTIFIED

ALL NEW
 minicircuits.com

P.O. Box 350166, Brooklyn, New York 11235-0003 (718) 934-4500 Fax (718) 332-4661 For detailed performance specs & shopping online see Mini-Circuits web site



The Design Engineers Search Engine Provides ACTUAL Data Instantly From MINI-CIRCUITS At: www.minicircuits.com

RF/IF MICROWAVE COMPONENTS

Tape & Reel Packaging TR-F6

DEVICE ORIENTATION IN T&R

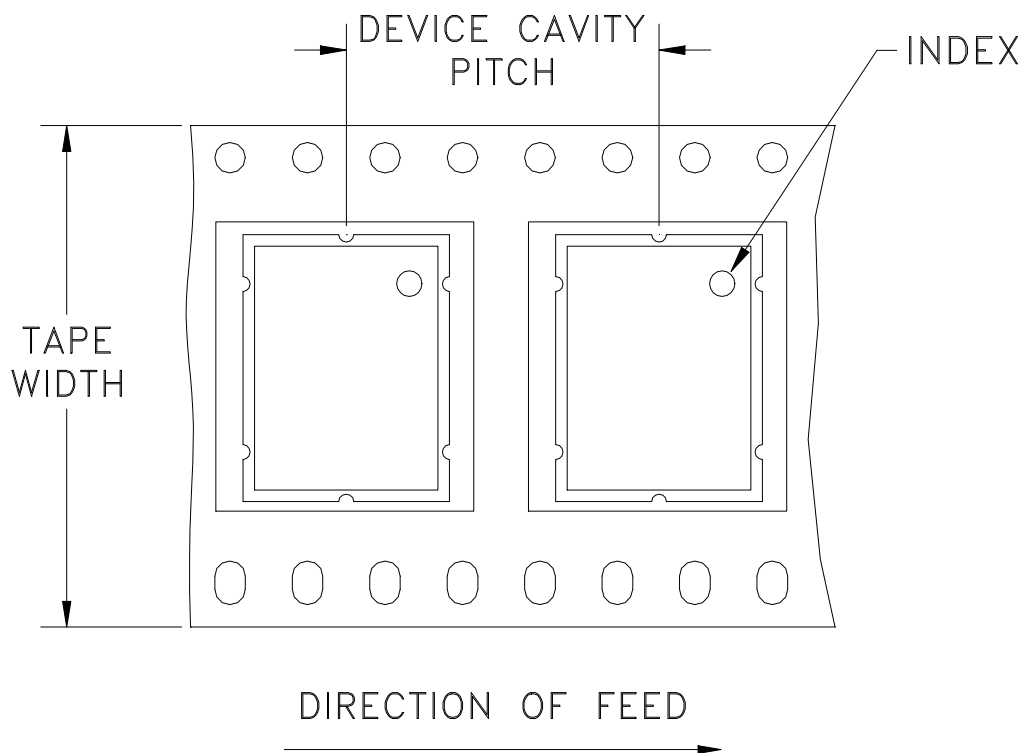

Tape Width, mm	Device Cavity Pitch, mm	Reel Size, inches	Devices per Reel
32	16	13	500

Mini-Circuits carrier tape materials provide protection from ESD (Electro-Static Discharge) during handling and transportation. Tapes are static dissipative and comply with industry standards EIA-481/EIA-541.

Go to: www.minicircuits.com/pages/pdfs/tape.pdf



Distribution Centers NORTH AMERICA 800-654-7949 • 417-335-5935 • Fax 417-335-5945 • EUROPE 44-1252-832600 • Fax 44-1252-837010

Mini-Circuits ISO 9001 & ISO 14001 Certified

INTERNET <http://www.minicircuits.com>

P.O. Box 350166, Brooklyn, New York 11235-0003 (718) 934-4500 Fax (718) 332-4661

THIRD ANGLE PROJECTION

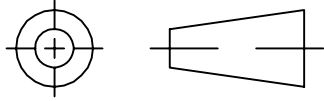

REVISIONS

REV	ECN No.	DESCRIPTION	DATE	DR	AUTH
OR	M107879	NEW RELEASE (FROM RAVON)	11/06	DK	HH
OR	R66100	NEW RELEASE (FROM RAVON)	11/06	DK	HH

**SUGGESTED MOUNTING CONFIGURATION FOR
HZ1198 CASE STYLE, "rg" PIN CONNECTION, 50 Ω**

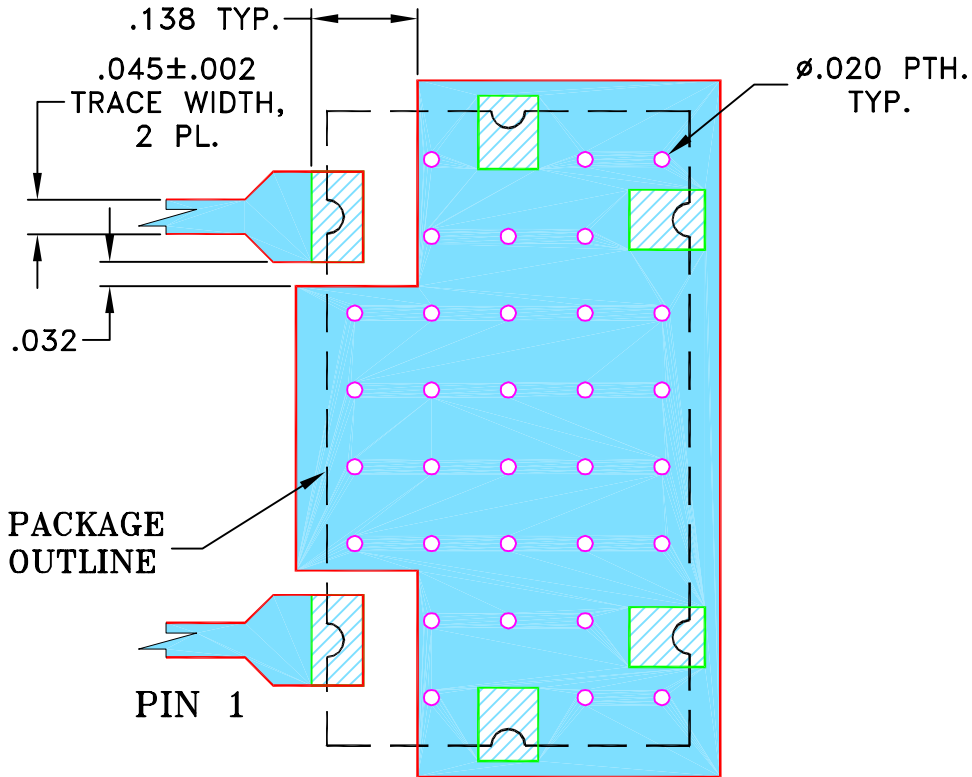

NOTES:

- TRACE WIDTH IS SHOWN FOR FR4 WITH DIELECTRIC THICKNESS $.025 \pm .002$ ". COPPER: 1/2 OZ. EACH SIDE.
FOR OTHER MATERIALS TRACE WIDTH MAY NEED TO BE MODIFIED.
- BOTTOM SIDE OF THE PCB IS CONTINUOUS GROUND PLANE.

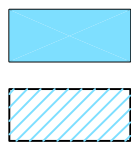

DENOTES PCB COPPER LAYOUT WITH SMOBC
(SOLDER MASK OVER BARE COPPER)

DENOTES COPPER LAND PATTERN FREE OF SOLDERMASK

UNLESS OTHERWISE SPECIFIED	INITIALS	DATE
DIMENSIONS ARE IN INCHES TOLERANCES ON: 2 PL DECIMALS ± 3 PL DECIMALS ± .005 ANGLES ± FRACTIONS ±	DRAWN	DK (RAVON) 14 NOV 06
	CHECKED	RZ (RAVON) 14 NOV 06
	APPROVED	HH (RAVON) 14 NOV 06



Mini-Circuits® 13 Neptune Avenue
Brooklyn NY 11235

PL, rg, HZ1198, DPLX, TB-400+
50 Ω

Mini-Circuits®
THIS DOCUMENT AND ITS CONTENTS ARE THE PROPERTY OF MINI-CIRCUITS. EXCEPT FOR USE EXPRESSLY GRANTED, IN WRITING, TO ITS VENDORS, VENDEE AND THE UNITED STATES GOVERNMENT, MINI-CIRCUITS RESERVES ALL PROPRIETARY DESIGN, USE, MANUFACTURING AND REPRODUCTION RIGHTS THERETO. THESE CONTENTS SHALL NOT BE USED, DUPLICATED OR DISCLOSED TO ANY OUTSIDE PARTY, IN WHOLE OR IN PART, WITHOUT WRITTEN PERMISSION OF MINI-CIRCUITS.

SIZE A	CODE IDENT 15542	DRAWING NO: 98-PL-247	REV: OR
FILE: 98PL247	SCALE: 4:1	SHEET: 1 OF 1	

Evaluation Board and Circuit

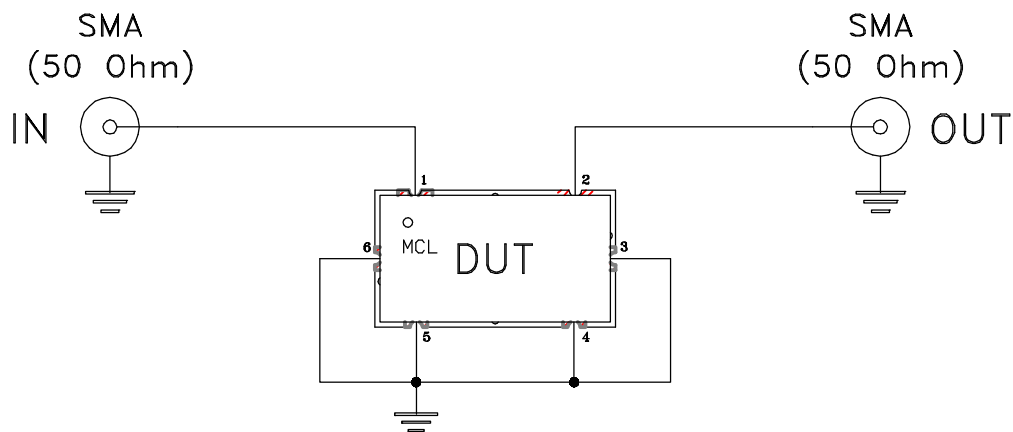
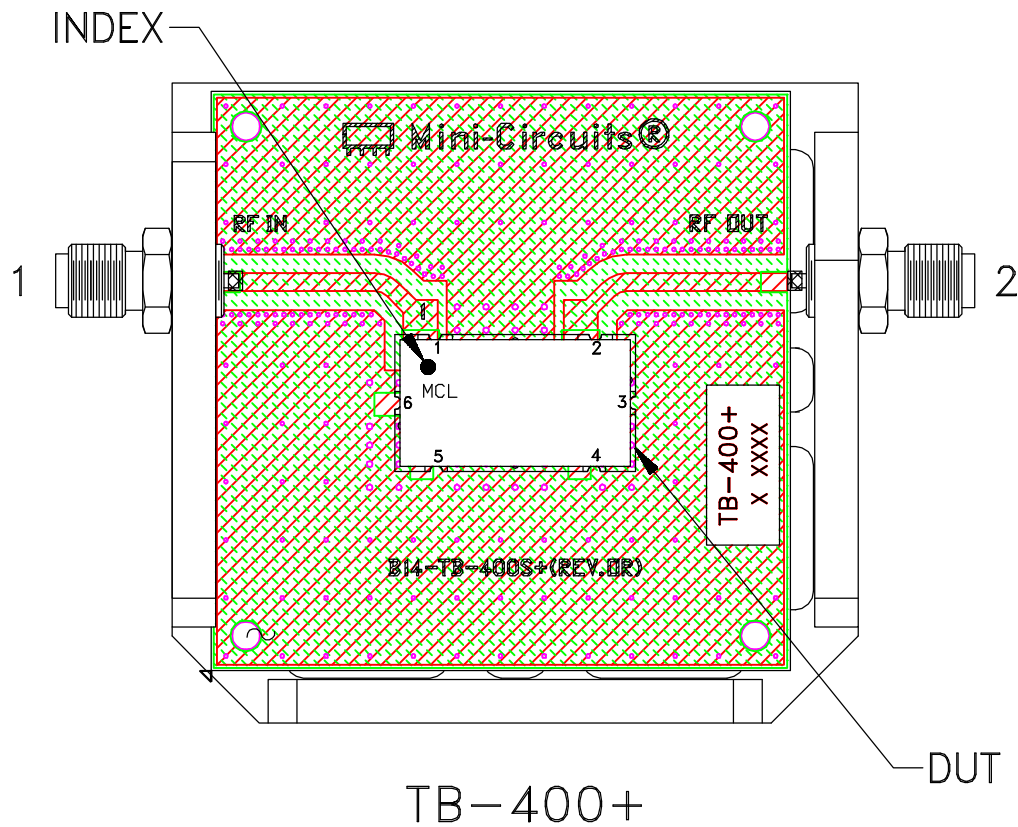

Schematic Diagram

Notes:

1. 50 Ohm SMA Female connectors.
2. PCB Material: R04350 or equivalent.
Dielectric Constant=3.5, Thickness=.030 inch.

 **Mini-Circuits®**

All Mini-Circuits products are manufactured under exacting quality assurance and control standards, and are capable of meeting published specifications after being subjected to any or all of the following physical and environmental test.

Specification	Test/Inspection Condition	Reference/Spec
Operating Temperature	-40° to 85° C Ambient Environment	Individual Model Data Sheet
Storage Temperature	-65° to 150° C Ambient Environment	Individual Model Data Sheet
Autoclave	15 psig, 100% RH, 121°C, 96 hours	JESD22-A102-C, Condition C
Temperature Cycling	-65° to 150°C, 100 cycles	JESD22-A104
Temperature Humidity	85°C/ 85% RH, 168 hours	JESD22-113
Solder Reflow Heat	Sn-Pb Eutetic Process: 240°C peak Pb-Free Process: 260°C peak	J-STD-020, Table 4-1, 4-2 and 5-2; Figure 5-1
Moisture Sensitivity: Level 1	Bake at 125°C for 24 hours Soak at 85°C/85% RH for 168 hours, Reflow 3 cycles at 240°C peak (Non-RoHS) or 260°C (RoHS)	J-STD-020
Solderability	10X magnification, 95% coverage	JESD22-B102, Method 1: Dip and Look Test
Mechanical Shock	50g, 11 ms, 1/2-sine, 18 shocks: 3 each direction, each of 3 axes	MIL-STD-202, Method 213, Condition A
Vibration (High Frequency)	20g peak, 10-2000 Hz, 12 times in each of three perpendicular directions (total 36)	MIL-STD-202, Method 204, Condition D