

Bandpass Filter

BPF-A76+

50Ω 74 to 77 MHz

Maximum Ratings

Operating Temperature	-40°C to 85°C
Storage Temperature	-55°C to 100°C
RF Power Input	0.5W at 25°C

Permanent damage may occur if any of these limits are exceeded.

Pin Connections

RF IN	1
RF OUT	8
GROUND	2,3,4,5,6,7,9,10,11,12,13,14

Outline Drawing

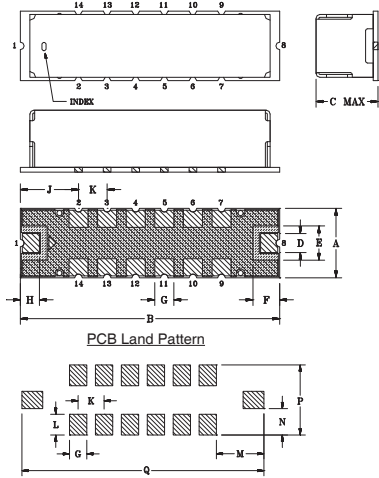

Suggested Layout
Tolerance to be within ±.002

METALLIZATION
 SOLDER RESIST

Outline Dimensions (inch/mm)

A	B	C	D	E	F	G	H
.365	1.360	.35	.100	.180	.140	.100	.100
9.27	34.54	8.89	2.54	4.57	3.56	2.54	2.54
J	K	L	M	N	P	Q	Wt.
.305	.150	.120	.275	.152	.405	1.400	grams
7.75	3.81	3.05	6.99	3.86	10.29	35.56	4.0

Note: Please refer to case style drawing for details

Demo Board MCL P/N: TB-363+ Suggested PCB Layout (PL-227)

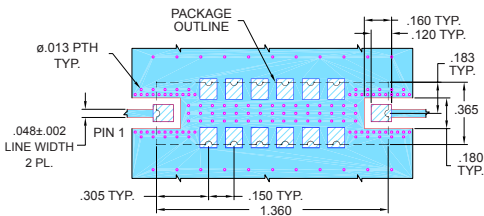

NOTES:

- TRACE WIDTH IS SHOWN FOR FR4 WITH DIELECTRIC THICKNESS: .025" ± .002". COPPER: 1/2 OZ. EACH SIDE. FOR OTHER MATERIALS TRACE WIDTH MAY NEED TO BE MODIFIED.
 - BOTTOM SIDE OF THE PCB IS CONTINUOUS GROUND PLANE.
- DENOTES PCB COPPER LAYOUT WITH SMOBC (SOLDER MASK OVER BARE COPPER)
- DENOTES COPPER LAND PATTERN FREE OF SOLDER MASK

Features

- Good VSWR, 1.3:1 typ @ passband
- High rejection
- Shielded case
- Aqueous washable

Applications

- Military communications
- Harmonic rejection
- Transmitters/receivers



Generic photo used for illustration purposes only

CASE STYLE: HQ1157

+RoHS Compliant

The +Suffix identifies RoHS Compliance. See our web site for RoHS Compliance methodologies and qualifications

Bandpass Filter Electrical Specifications (T_{AMB} = 25°C)

CENTER FREQ. (MHz)	PASSBAND (MHz) (Loss < 4dB)	STOPBANDS (MHz)				VSWR (:1)		
		Loss > 20dB		Loss > 40dB		Passband		Stopband
F _c	F ₁ - F ₂	F ₃	F ₄	F ₅	F ₆	Typ.	Max.	Typ.
75.5	74 - 77	65	86	60	94 - 1000	1.3	1.8	20

Typical Frequency Response

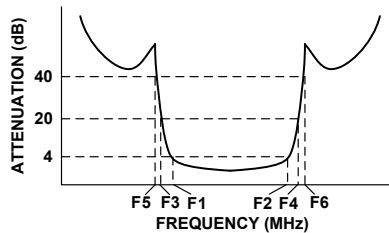

Functional Schematic

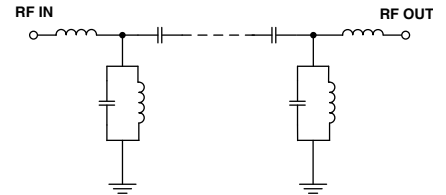

Typical Performance Data at 25°C

Frequency (MHz)	Insertion Loss (dB)	VSWR (:1)
0.5	90.50	24.14
60.0	55.22	66.82
65.0	31.16	20.22
68.0	15.22	2.93
69.0	9.91	2.34
70.0	4.60	1.97
74.0	2.92	1.43
75.0	2.87	1.38
75.5	2.88	1.42
76.0	2.91	1.42
77.0	3.00	1.20
80.0	4.20	1.78
82.0	9.85	3.69
84.0	21.80	10.75
86.0	30.91	16.89
94.0	52.87	36.20
500.0	93.71	347.44
1000.0	96.30	157.93

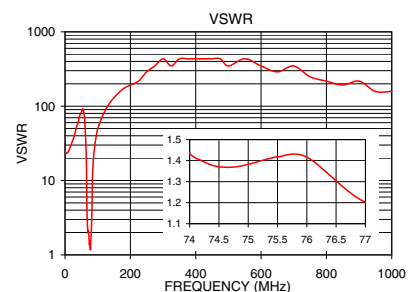
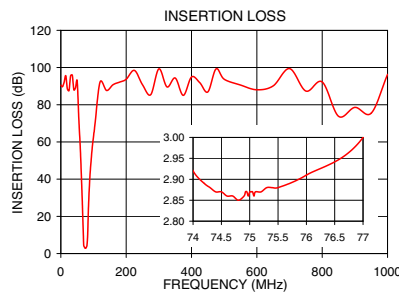

Notes

- Performance and quality attributes and conditions not expressly stated in this specification document are intended to be excluded and do not form a part of this specification document.
- Electrical specifications and performance data contained in this specification document are based on Mini-Circuit's applicable established test performance criteria and measurement instructions.
- The parts covered by this specification document are subject to Mini-Circuits standard limited warranty and terms and conditions (collectively, "Standard Terms"); Purchasers of this part are entitled to the rights and benefits contained therein. For a full statement of the Standard Terms and the exclusive rights and remedies thereunder, please visit Mini-Circuits' website at www.minicircuits.com/MCLStore/terms.jsp



Surface Mount Band Pass Filter

BPF-A76+

Typical Performance Data

FREQ. (MHz)	INSERTION LOSS (dB)			INPUT RETURN LOSS (dB)			OUTPUT RETURNLOSS (dB)		
	@ -40° C	@ +25° C	@ +85° C	@ -40° C	@ +25° C	@ +85° C	@ -40° C	@ +25° C	@ +85° C
0.5	100.57	104.01	103.51	0.58	0.76	0.93	0.57	0.76	0.94
10.0	90.57	87.99	94.67	0.57	0.74	0.87	0.56	0.74	0.87
20.0	88.23	88.63	82.54	0.46	0.57	0.67	0.46	0.57	0.66
30.0	89.89	89.46	83.16	0.34	0.41	0.46	0.35	0.41	0.47
40.0	85.15	90.46	88.96	0.25	0.29	0.33	0.24	0.30	0.33
50.0	105.32	96.46	85.45	0.19	0.22	0.24	0.18	0.22	0.26
60.0	58.71	57.68	57.69	0.21	0.25	0.26	0.19	0.26	0.29
61.0	54.72	53.50	53.99	0.23	0.28	0.29	0.20	0.28	0.31
62.0	50.72	49.33	49.64	0.26	0.31	0.34	0.24	0.33	0.37
63.0	46.24	44.78	45.25	0.30	0.37	0.40	0.29	0.40	0.44
64.0	41.47	39.92	40.43	0.37	0.47	0.51	0.37	0.51	0.55
65.0	36.26	34.59	35.14	0.49	0.63	0.67	0.48	0.68	0.71
66.0	30.51	28.71	29.33	0.71	0.91	0.96	0.71	1.00	1.02
67.0	24.14	22.23	22.97	1.10	1.48	1.54	1.11	1.62	1.60
68.0	17.13	15.27	16.11	2.02	2.86	2.91	2.02	2.99	2.87
69.0	10.16	8.99	9.77	4.65	6.73	6.70	4.40	6.47	6.02
70.0	5.51	5.42	5.91	11.29	14.26	14.61	9.83	12.25	12.00
71.0	3.86	4.21	4.49	12.95	12.43	12.99	13.12	12.98	14.20
72.0	3.36	3.72	3.94	10.57	10.54	11.00	11.50	11.32	12.40
73.0	3.03	3.35	3.55	10.87	11.78	12.10	11.15	11.78	12.60
74.0	2.70	3.06	3.27	15.08	17.61	17.27	13.66	14.98	15.69
75.0	2.55	2.97	3.18	26.46	22.04	21.38	17.24	16.83	17.78
75.5	2.57	3.00	3.20	20.53	17.68	17.96	16.44	15.52	16.47
76.0	2.60	3.02	3.22	16.48	15.44	15.88	14.87	14.36	15.25
77.0	2.65	3.06	3.27	14.70	15.81	16.31	13.78	14.34	15.20
80.0	3.60	4.17	4.42	10.90	10.77	10.90	9.13	9.28	9.60
82.0	5.12	7.08	7.27	11.11	8.06	8.36	13.62	8.97	9.74
84.0	17.14	19.29	19.21	1.96	1.96	2.11	1.88	1.87	2.10
86.0	27.63	29.11	29.04	1.08	1.17	1.27	0.98	1.08	1.22
90.0	41.75	42.65	42.60	0.63	0.71	0.76	0.57	0.65	0.74
94.0	51.71	52.07	52.24	0.47	0.54	0.58	0.42	0.51	0.57
95.0	53.44	54.15	54.09	0.43	0.50	0.54	0.40	0.47	0.54
100.0	62.63	62.86	62.54	0.34	0.39	0.43	0.30	0.38	0.43
110.0	76.99	73.53	76.48	0.25	0.29	0.32	0.21	0.28	0.33
120.0	83.22	90.99	82.58	0.20	0.24	0.26	0.18	0.23	0.27
130.0	95.77	90.72	94.77	0.16	0.20	0.22	0.14	0.20	0.24
140.0	88.09	86.51	85.30	0.13	0.18	0.20	0.12	0.18	0.22
150.0	87.82	87.39	85.71	0.12	0.17	0.18	0.10	0.17	0.20
200.0	89.41	84.66	90.07	0.07	0.12	0.14	0.06	0.13	0.17
250.0	91.10	88.14	84.83	0.06	0.11	0.14	0.04	0.12	0.16
300.0	84.32	87.45	92.84	0.07	0.11	0.15	0.03	0.11	0.18
350.0	87.14	103.36	95.20	0.04	0.10	0.14	0.03	0.13	0.19
400.0	86.95	98.49	93.73	0.04	0.11	0.14	0.03	0.14	0.22
450.0	91.14	91.15	86.35	0.06	0.13	0.18	0.03	0.14	0.22
500.0	88.44	90.85	85.86	0.05	0.12	0.18	0.03	0.16	0.25
550.0	88.13	83.07	87.43	0.07	0.15	0.20	0.04	0.19	0.26
600.0	93.62	85.25	85.56	0.07	0.15	0.21	0.04	0.19	0.28
650.0	88.55	85.38	83.72	0.07	0.18	0.24	0.05	0.21	0.30
700.0	87.73	102.23	91.22	0.08	0.19	0.25	0.04	0.22	0.31
750.0	91.61	100.16	91.21	0.10	0.20	0.26	0.06	0.23	0.33
800.0	93.91	80.68	97.55	0.07	0.19	0.27	0.07	0.26	0.37
850.0	74.29	74.94	72.96	0.11	0.22	0.30	0.08	0.27	0.38
900.0	85.89	84.04	78.09	0.09	0.22	0.32	0.09	0.29	0.39
950.0	71.97	72.79	78.27	0.12	0.26	0.33	0.09	0.31	0.42
1000.0	87.47	83.42	85.83	0.11	0.23	0.32	0.08	0.30	0.41

REV. X1

BPF-A76+

091220

Page 1 of 2



IF/RF MICROWAVE COMPONENTS • ISO 9001 ISO 14001 AS 9100 CERTIFIED • RoHS compliant

P.O. Box 350166, Brooklyn, New York 11235-0003 (718) 934-4500 Fax (718) 332-4661



The Design Engineers Search Engine finds the model you need, Instantly • For detailed performance specs & shopping online see



Surface Mount Band Pass Filter

BPF-A76+

Typical Performance Data

FREQ. (MHz)	GROUP DELAY (nsec)		
	@ -40° C	@ +25° C	@ +85° C
72.00	121.25	116.03	117.69
72.25	117.10	112.82	114.37
72.50	113.48	110.18	111.64
72.75	110.91	108.21	109.58
73.00	108.63	106.78	107.91
73.25	107.18	105.61	106.64
73.50	105.90	104.72	105.62
73.75	105.32	104.14	104.67
74.00	104.48	103.55	103.93
74.25	104.10	102.91	103.11
74.50	103.20	102.23	102.18
74.75	102.62	101.18	101.24
75.00	101.70	100.20	100.36
75.25	100.79	99.10	99.28
75.50	99.54	98.01	98.34
75.75	98.63	97.14	97.48
76.00	97.59	96.68	97.12
76.25	96.88	96.43	96.83
76.50	96.58	96.43	96.91
76.75	96.32	96.87	97.12
77.00	96.70	97.69	97.99
77.25	97.47	98.62	98.64
77.50	98.48	99.66	99.66
77.75	99.56	100.87	100.85
78.00	101.06	101.77	101.75
78.25	102.26	102.71	102.57
78.50	103.19	103.21	103.14
78.75	103.65	103.52	103.42
79.00	103.94	103.63	103.36
79.25	103.76	103.84	103.64
79.50	103.66	104.15	104.06
79.75	103.86	105.52	105.31
80.00	104.59	107.77	107.32

REV. X1
BPF-A76+
091220
Page 2 of 2



IF/RF MICROWAVE COMPONENTS • ISO 9001 ISO 14001 AS 9100 CERTIFIED RoHS compliant
P.O. Box 350166, Brooklyn, New York 11235-0003 (718) 934-4500 Fax (718) 332-4661



The Design Engineers Search Engine finds the model you need, Instantly • For detailed performance specs & shopping online see



Typical Performance Curves

INSERTION LOSS vs. TEMPERATURE

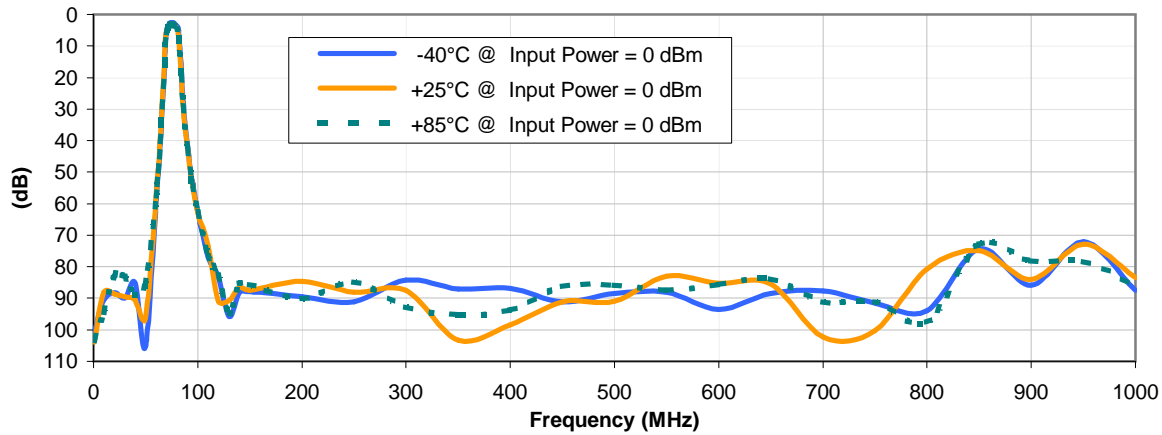

INPUT RETURN LOSS vs. TEMPERATURE

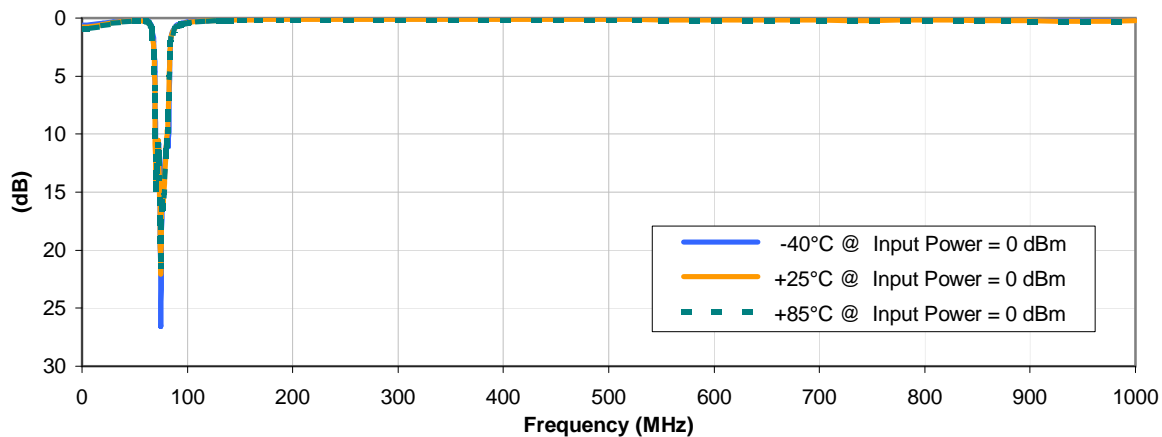

OUTPUT RETURN LOSS vs. TEMPERATURE

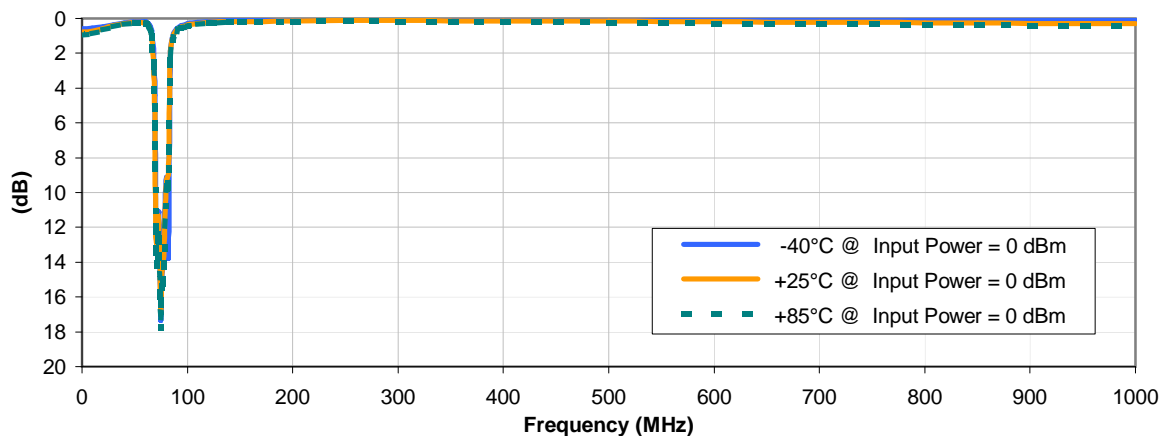

REV. X1
BPF-A76+
091220
Page 1 of 2



IF/RF MICROWAVE COMPONENTS • ISO 9001 ISO 14001 AS 9100 CERTIFIED • RoHS compliant
P.O. Box 350166, Brooklyn, New York 11235-0003 (718) 934-4500 Fax (718) 332-4661



The Design Engineers Search Engine finds the model you need, Instantly • For detailed performance specs & shopping online see



Typical Performance Curves

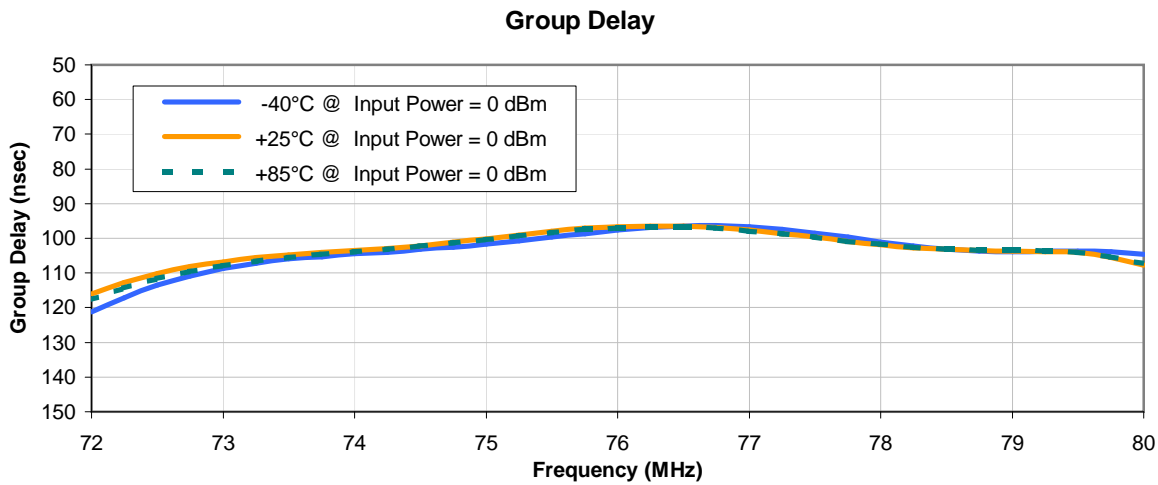

REV. X1
BPF-A76+
091220
Page 2 of 2



IF/RF MICROWAVE COMPONENTS • ISO 9001 ISO 14001 AS 9100 CERTIFIED RoHS compliant
P.O. Box 350166, Brooklyn, New York 11235-0003 (718) 934-4500 Fax (718) 332-4661



The Design Engineers Search Engine finds the model you need, Instantly • For detailed performance specs & shopping online see



Case Style

HQ

Outline Dimensions

HQ1157



CASE#	A	B	C	D	E	F	G	H	J	K	L	M
HQ1157	.365 (9.27)	1.360 (34.54)	.350 (8.89)	.100 (2.54)	.180 (4.57)	.140 (3.56)	.100 (2.54)	.100 (2.54)	.305 (7.75)	.150 (3.81)	.120 (3.05)	.275 (6.99)

CASE#	N	P	Q	WT.GRAM
HQ1157	.152 (3.87)	.405 (10.29)	1.400 (35.56)	4.0

Dimensions are in inches (mm). Tolerances: 2Pl. ± .03; 3Pl. ± .015

Notes:

- Case material: Nickel-Silver alloy.
- Base: Printed wiring laminate.
- Termination finish:
 - For RoHS Case Styles: 3-5 μ inch (.08-.13 microns) Gold over 120-240 μ inch (3.05-6.10 microns) Nickel plate.
 - For RoHS-5 Case Styles: Tin-Lead plate.

Mini-Circuits®
ISO 9001 ISO 14001 CERTIFIED

ALL NEW
minicircuits.com

P.O. Box 350166, Brooklyn, New York 11235-0003 (718) 934-4500 Fax (718) 332-4661 For detailed performance specs & shopping online see Mini-Circuits web site



The Design Engineers Search Engine Provides ACTUAL Data Instantly From MINI-CIRCUITS At: www.minicircuits.com

RF/IF MICROWAVE COMPONENTS

Tape & Reel Packaging TR-F83

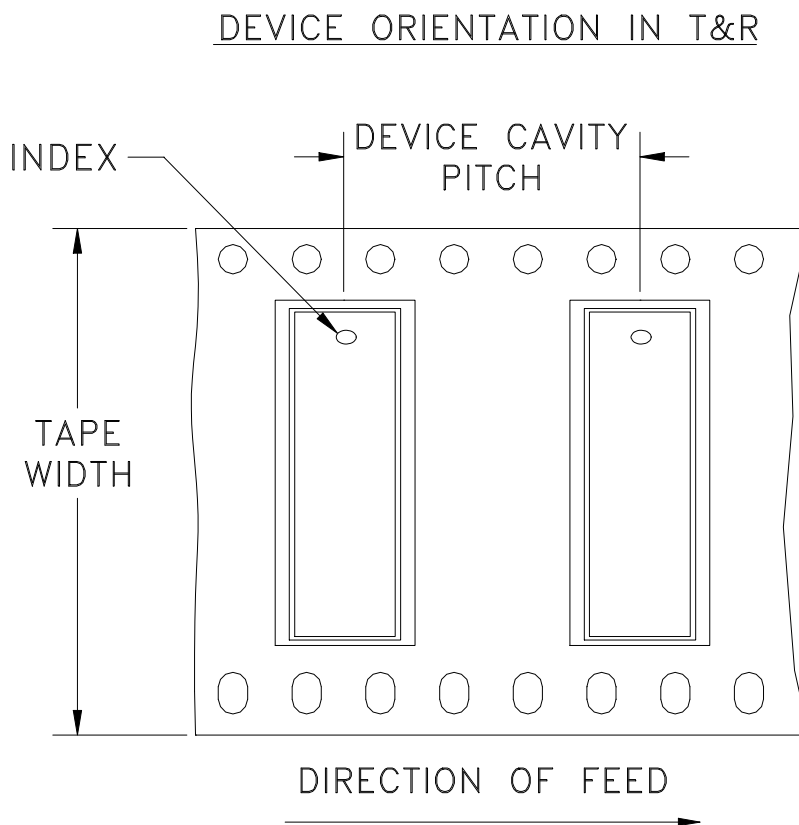

Tape Width, mm	Device Cavity Pitch, mm	Reel Size, inches	Devices per Reel
56	16	13	100

Mini-Circuits carrier tape materials provide protection from ESD (Electro-Static Discharge) during handling and transportation. Tapes are static dissipative and comply with industry standards EIA-481/EIA-541.

Go to: www.minicircuits.com/pages/pdfs/tape.pdf



INTERNET <http://www.minicircuits.com>

P.O. Box 350166, Brooklyn, New York 11235-0003 (718) 934-4500 Fax (718) 332-4661

Distribution Centers NORTH AMERICA 800-654-7949 • 417-335-5935 • Fax 417-335-5945 • EUROPE 44-1252-832600 • Fax 44-1252-837010

Mini-Circuits ISO 9001 & ISO 14001 Certified

THIRD ANGLE PROJECTION



REVISIONS

REV	ECN No.	DESCRIPTION	DATE	DR	AUTH
OR	M101212	NEW RELEASE (FROM RAVON)	11/05	DK	YB
A	M108938	SWITCH HATCHES	12/06	DK	HH
B	M118075	CHANGE LINE PLACES	06/08	HB	HH
C	M173459	CORRECTED CASE STYLE & TB PART#	03/27/19	ITG	IL

**SUGGESTED MOUNTING CONFIGURATION
FOR HQ1157 CASE STYLE, rf PIN CONNECTION**

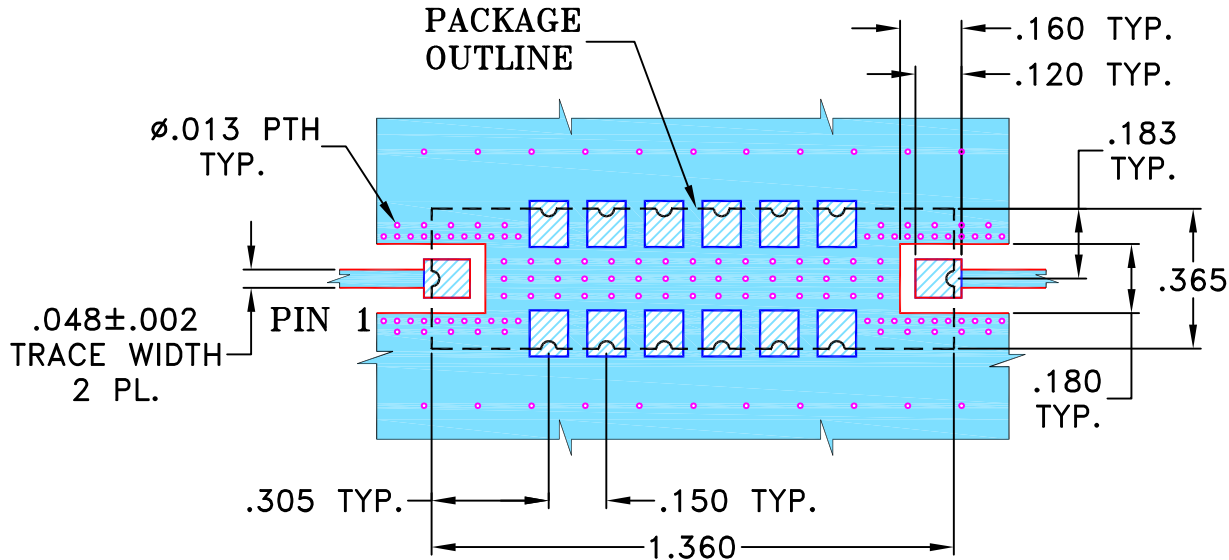

NOTE:

- TRACE WIDTH IS SHOWN FOR FR4 WITH DIELECTRIC THICKNESS .025" ± .002". COPPER: 1/2 OZ. EACH SIDE.
FOR OTHER MATERIALS TRACE WIDTH MAY NEED TO BE MODIFIED.
- BOTTOM SIDE OF THE PCB IS CONTINUOUS GROUND PLANE.

- DENOTES PCB COPPER LAYOUT WITH SMOBC (SOLDER MASK OVER BARE COPPER)
- DENOTES COPPER LAND PATTERN FREE OF SOLDERMASK

UNLESS OTHERWISE SPECIFIED	INITIALS		DATE
DIMENSIONS ARE IN INCHES TOLERANCES ON: 2 PL DECIMALS ± 3 PL DECIMALS ± .005 ANGLES ± FRACTIONS ±	DRAWN	HB (RAVON)	12 JUN 2008
	CHECKED	RZ (RAVON)	12 JUN 2008
	APPROVED	HH (RAVON)	12 JUN 2008

Mini-Circuits[®] 13 Neptune Avenue
Brooklyn NY 11235

PL, rf, HQ1157, TB-363+, 50 OHM

THIS DOCUMENT AND ITS CONTENTS ARE THE PROPERTY OF MINI-CIRCUITS. EXCEPT FOR USE EXPRESSLY GRANTED, IN WRITING, TO ITS VENDORS, VENDEE AND THE UNITED STATES GOVERNMENT, MINI-CIRCUITS RESERVES ALL PROPRIETARY DESIGN, USE, MANUFACTURING AND REPRODUCTION RIGHTS THERETO. THESE CONTENTS SHALL NOT BE USED, DUPLICATED OR DISCLOSED TO ANY OUTSIDE PARTY, IN WHOLE OR IN PART, WITHOUT WRITTEN PERMISSION OF MINI-CIRCUITS.

SIZE A	CODE IDENT 15542	DRAWING NO: 98-PL-227	REV: C
FILE: 98PL227	SCALE: 2:1	SHEET: 1 OF 1	

Evaluation Board and Circuit

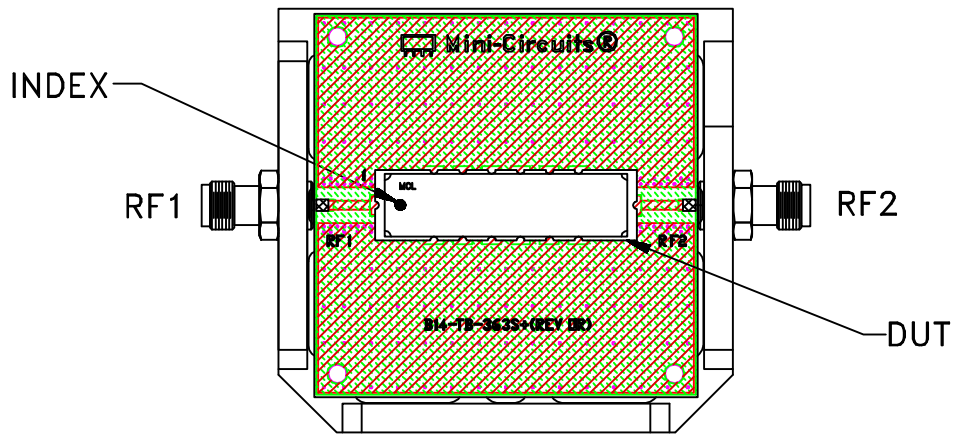

TB-363+

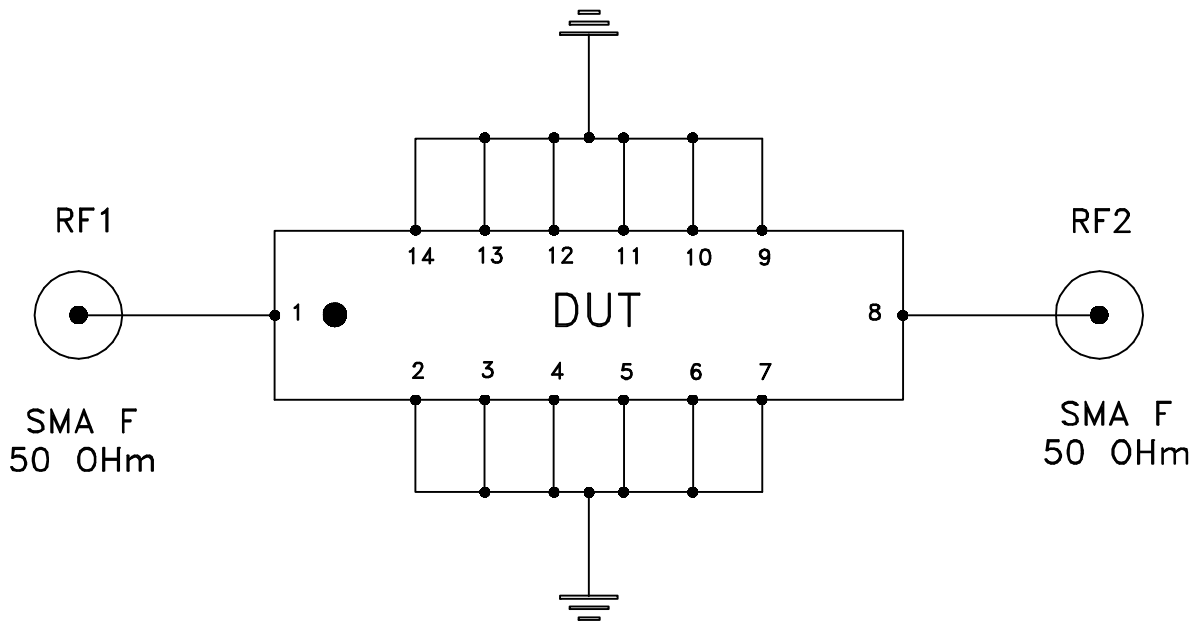

Schematic Diagram

Notes:

1. 50 Ohm SMA Female connectors.
2. PCB Material: ROGERS R04350 or equivalent,
Dielectric Constant=3.48, Thickness=.030 inch.

 **Mini-Circuits®**

All Mini-Circuits products are manufactured under exacting quality assurance and control standards, and are capable of meeting published specifications after being subjected to any or all of the following physical and environmental test.

Specification	Test/Inspection Condition	Reference/Spec
Operating Temperature	-40° to 85° C Ambient Environment	Individual Model Data Sheet
Storage Temperature	-65° to 150° C Ambient Environment	Individual Model Data Sheet
Autoclave	15 psig, 100% RH, 121°C, 96 hours	JESD22-A102-C, Condition C
Temperature Cycling	-65° to 150°C, 100 cycles	JESD22-A104
Temperature Humidity	85°C/ 85% RH, 168 hours	JESD22-113
Solder Reflow Heat	Sn-Pb Eutetic Process: 240°C peak Pb-Free Process: 260°C peak	J-STD-020, Table 4-1, 4-2 and 5-2; Figure 5-1
Moisture Sensitivity: Level 1	Bake at 125°C for 24 hours Soak at 85°C/85% RH for 168 hours, Reflow 3 cycles at 240°C peak (Non-RoHS) or 260°C (RoHS)	J-STD-020
Solderability	10X magnification, 95% coverage	JESD22-B102, Method 1: Dip and Look Test
Mechanical Shock	50g, 11 ms, 1/2-sine, 18 shocks: 3 each direction, each of 3 axes	MIL-STD-202, Method 213, Condition A
Vibration (High Frequency)	20g peak, 10-2000 Hz, 12 times in each of three perpendicular directions (total 36)	MIL-STD-202, Method 204, Condition D