

Surface Mount

# Power Splitter/Combiner

2 Way-0° 50Ω 1400 to 2350 MHz

BP2P1+



Generic photo used for illustration purposes only

CASE STYLE: XX211

**+RoHS Compliant**

The +Suffix identifies RoHS Compliance. See our web site for RoHS Compliance methodologies and qualifications

Available Tape and Reel at no extra cost	
Reel Size	Devices/Reel
7"	20, 50, 100, 200, 500, 1000
13"	2000

## Maximum Ratings

Operating Temperature	-40°C to 85°C
Storage Temperature	-65°C to 150°C
Power Input (as a splitter)	1.5W max.
Internal Dissipation	0.75W max.

Permanent damage may occur if any of these limits are exceeded.

## Pin Connections

SUM PORT	2
PORT 1	8
PORT 2	5
GROUND	1,3,4,6,7

## Features

- low insertion loss, 0.5 dB typ.
- high isolation, 20 dB typ.
- good output VSWR, 1.35:1 typ.
- excellent power handling, 1.5W
- excellent repeatability
- low profile
- aqueous washable

## Applications

- PCS/DCS
- GSM
- WCDMA

## Electrical Specifications

FREQ. RANGE (MHz)	ISOLATION (dB)		INSERTION LOSS (dB) ABOVE 3.0 dB		PHASE UNBALANCE (Degrees)	AMPLITUDE UNBALANCE (dB)	VSWR (:1)	
	Typ.	Min.	Typ.	Max.			S-Port Typ.	Output-Ports Typ.
1400-2350	20	10	0.5	1.3	4.0	0.3	1.55	1.35

## Outline Drawing

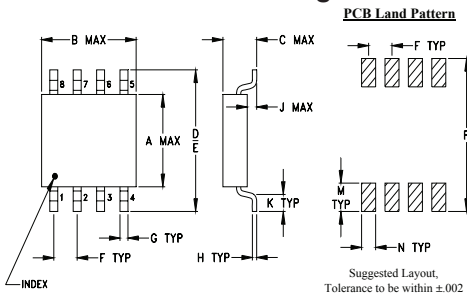

## Outline Dimensions (inch/mm)

A	B	C	D	E	F	G
.163	.210	.077	.250	.220	.050	.017
4.14	5.33	1.96	6.35	5.59	1.27	0.43

H	J	K	M	N	P	wt
.009	.025	.030	.050	.030	.270	grams
0.23	0.64	0.76	1.27	0.76	6.86	0.10

## Demo Board MCL P/N: TB-37 Suggested PCB Layout (PL-053)

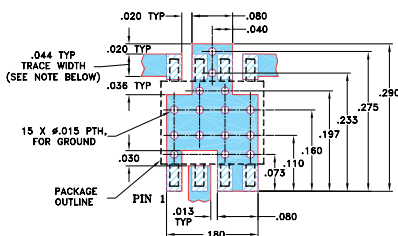

- NOTES: 1. TRACE WIDTH IS SHOWN FOR ROGERS R04350B WITH DIELECTRIC THICKNESS 0.020" ± 0.0015". COPPER: 1/2 OZ. EACH SIDE. FOR OTHER MATERIALS TRACE WIDTH MAY NEED TO BE MODIFIED.
2. BOTTOM SIDE OF THE PCB IS CONTINUOUS GROUND PLANE.

- DENOTES PCB COPPER LAYOUT WITH SMOBC (SOLDER MASK OVER BARE COPPER)
- DENOTES COPPER LAND PATTERN FREE OF SOLDER MASK

### Notes

- A. Performance and quality attributes and conditions not expressly stated in this specification document are intended to be excluded and do not form a part of this specification document.
- B. Electrical specifications and performance data contained in this specification document are based on Mini-Circuit's applicable established test performance criteria and measurement instructions.
- C. The parts covered by this specification document are subject to Mini-Circuits standard limited warranty and terms and conditions (collectively, "Standard Terms"). Purchasers of this part are entitled to the rights and benefits contained therein. For a full statement of the Standard Terms and the exclusive rights and remedies thereunder, please visit Mini-Circuits' website at [www.minicircuits.com/MCLStore/terms.jsp](http://www.minicircuits.com/MCLStore/terms.jsp)

## Typical Performance Data at 25°C

Frequency (MHz)	Total Loss <sup>1</sup> (dB)		Amplitude Unbalance (dB)	Isolation (dB)	Phase Unbalance (deg.)	VSWR S	VSWR 1	VSWR 2
	S-1	S-2						
1400.00	3.41	3.40	0.01	12.85	0.10	1.25	1.43	1.45
1450.00	3.40	3.39	0.01	13.97	0.10	1.21	1.38	1.40
1500.00	3.40	3.38	0.02	15.28	0.08	1.17	1.33	1.35
1600.00	3.40	3.37	0.03	18.71	0.03	1.09	1.24	1.26
1700.00	3.41	3.37	0.04	24.36	0.00	1.02	1.15	1.16
1800.00	3.44	3.39	0.05	42.86	0.05	1.07	1.08	1.09
1900.00	3.49	3.43	0.06	27.01	0.10	1.17	1.10	1.10
2000.00	3.55	3.48	0.07	20.65	0.16	1.28	1.19	1.18
2050.00	3.60	3.52	0.08	18.73	0.20	1.35	1.24	1.23
2100.00	3.65	3.56	0.08	17.22	0.22	1.41	1.30	1.28
2150.00	3.70	3.61	0.09	15.98	0.29	1.49	1.36	1.34
2200.00	3.77	3.67	0.10	14.94	0.33	1.57	1.42	1.41
2250.00	3.84	3.74	0.10	14.02	0.39	1.66	1.49	1.47
2300.00	3.92	3.81	0.11	13.23	0.44	1.75	1.56	1.54
2350.00	4.01	3.90	0.12	12.53	0.49	1.85	1.63	1.61

1. Total Loss = Insertion Loss + 3dB splitter loss.

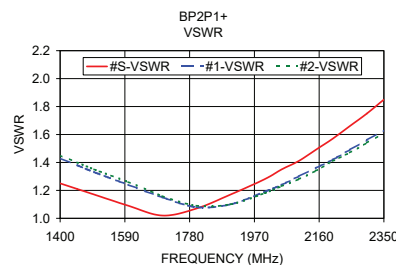
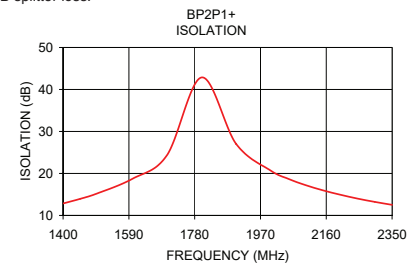
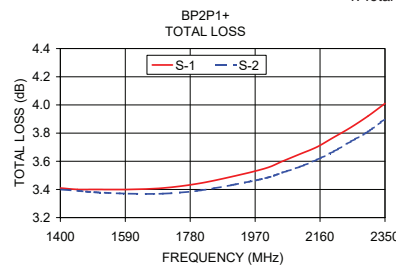

## electrical schematic

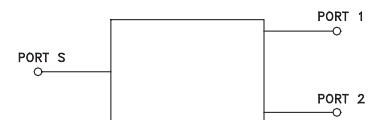

## ESD Rating

Human Body Model (HBM): Class 0 (<250V) in accordance with ANSI/ESD STM 5.1 - 2001  
Machine Model (MM): Class M1 (<100V) in accordance with ANSI/ESD STM 5.2 - 1999 (pass 50V)



# 2 Way-0° Power Splitter/Combiner

# BP2P1+

## Typical Performance Data

TEST CONDITIONS: INPUT POWER = 0dBm @Temperature = +25°C

FREQ. (MHz)	TOTAL LOSS <sup>1</sup> (dB)		AMP. UNBAL. (dB)	PHASE UNBAL. (deg.)	ISOLATION (dB)	VSWR (:1)		
	S-1	S-2				S	1	2
1000	3.51	3.50	0.01	0.85	7.25	1.59	1.70	1.71
1050	3.49	3.48	0.01	0.88	7.68	1.56	1.68	1.68
1100	3.48	3.47	0.01	0.93	8.18	1.53	1.64	1.65
1150	3.47	3.45	0.02	1.01	8.72	1.50	1.61	1.62
1200	3.46	3.44	0.02	1.02	9.31	1.47	1.57	1.58
1250	3.45	3.43	0.02	1.07	9.96	1.43	1.54	1.54
1300	3.43	3.41	0.02	1.10	10.70	1.40	1.50	1.50
1350	3.42	3.39	0.03	1.15	11.51	1.36	1.45	1.46
1400	3.41	3.38	0.03	1.19	12.43	1.32	1.41	1.41
1450	3.40	3.37	0.03	1.29	13.47	1.28	1.37	1.37
1500	3.39	3.36	0.03	1.35	14.65	1.24	1.32	1.32
1550	3.39	3.35	0.04	1.36	16.05	1.20	1.28	1.28
1600	3.38	3.34	0.04	1.44	17.69	1.16	1.23	1.23
1650	3.38	3.33	0.05	1.46	19.68	1.12	1.18	1.19
1700	3.38	3.33	0.05	1.57	22.28	1.08	1.14	1.14
1750	3.38	3.33	0.05	1.64	25.87	1.04	1.10	1.10
1800	3.39	3.34	0.05	1.71	31.85	1.03	1.06	1.06
1850	3.40	3.35	0.05	1.77	40.94	1.07	1.03	1.04
1900	3.42	3.36	0.06	1.81	30.99	1.12	1.06	1.06
1950	3.45	3.38	0.07	1.92	25.69	1.17	1.10	1.10
2000	3.48	3.42	0.06	1.96	22.39	1.24	1.15	1.14
2050	3.52	3.46	0.06	2.03	20.05	1.30	1.20	1.19
2100	3.57	3.50	0.07	2.18	18.25	1.38	1.25	1.25
2150	3.63	3.55	0.08	2.22	16.78	1.46	1.31	1.31
2200	3.70	3.62	0.08	2.31	15.58	1.55	1.37	1.36
2250	3.78	3.69	0.09	2.43	14.51	1.65	1.44	1.43
2300	3.86	3.78	0.08	2.55	13.58	1.76	1.51	1.49
2350	3.97	3.88	0.09	2.66	12.78	1.87	1.58	1.57
2360	3.99	3.90	0.09	2.70	12.62	1.90	1.59	1.58
2370	4.02	3.93	0.09	2.72	12.47	1.92	1.61	1.59
2380	4.04	3.95	0.09	2.75	12.35	1.95	1.62	1.61
2390	4.06	3.97	0.09	2.78	12.22	1.98	1.64	1.63
2400	4.09	3.99	0.10	2.80	12.08	2.01	1.65	1.64
2450	4.21	4.11	0.10	2.94	11.43	2.16	1.73	1.72
2500	4.36	4.25	0.11	3.11	10.85	2.32	1.82	1.80
2550	4.51	4.40	0.11	3.27	10.33	2.50	1.91	1.89
2560	4.54	4.44	0.10	3.30	10.23	2.53	1.93	1.90
2570	4.59	4.47	0.12	3.30	10.12	2.57	1.95	1.91
2580	4.62	4.50	0.12	3.31	10.02	2.61	1.97	1.93
2590	4.66	4.54	0.12	3.33	9.93	2.65	1.98	1.95
2600	4.69	4.57	0.12	3.41	9.84	2.69	2.00	1.97
2650	4.88	4.75	0.13	3.55	9.40	2.91	2.10	2.06
2660	4.91	4.79	0.12	3.60	9.32	2.95	2.12	2.08
2670	4.96	4.83	0.13	3.57	9.23	2.99	2.14	2.10
2680	5.00	4.87	0.13	3.62	9.15	3.04	2.17	2.12
2690	5.04	4.91	0.13	3.68	9.07	3.09	2.18	2.14
2700	5.09	4.95	0.14	3.70	8.99	3.14	2.20	2.16
2750	5.31	5.16	0.15	3.90	8.62	3.40	2.31	2.26
2800	5.55	5.38	0.17	4.10	8.29	3.67	2.42	2.36
2850	5.79	5.61	0.18	4.26	7.98	3.98	2.54	2.47
2900	6.06	5.87	0.19	4.43	7.69	4.31	2.66	2.58
2950	6.34	6.13	0.21	4.67	7.44	4.67	2.78	2.69
3000	6.63	6.41	0.22	4.86	7.20	5.04	2.91	2.81

<sup>1</sup>Total Loss = Insertion Loss + 3dB Splitter Loss

REV. X2  
BP2P1+  
100623  
Page 1 of 3



IF/RF MICROWAVE COMPONENTS • ISO 9001 ISO 14001 AS 9100 CERTIFIED • RoHS compliant  
P.O. Box 350166, Brooklyn, New York 11235-0003 (718) 934-4500 Fax (718) 332-4661



The Design Engineers Search Engine finds the model you need, Instantly • For detailed performance specs & shopping online see



# 2 Way-0° Power Splitter/Combiner

# BP2P1+

## Typical Performance Data

TEST CONDITIONS: INPUT POWER = 0dBm @Temperature = -40°C

FREQ. (MHz)	TOTAL LOSS <sup>1</sup> (dB)		AMP. UNBAL. (dB)	PHASE UNBAL. (deg.)	ISOLATION (dB)	VSWR (:1)		
	S-1	S-2				S	1	2
1000	3.39	3.40	0.01	0.79	7.07	1.62	1.73	1.74
1050	3.37	3.37	0.00	0.83	7.52	1.58	1.70	1.71
1100	3.36	3.36	0.00	0.87	7.97	1.56	1.66	1.68
1150	3.35	3.35	0.00	0.98	8.48	1.53	1.63	1.64
1200	3.34	3.32	0.02	0.97	9.07	1.48	1.60	1.60
1250	3.31	3.30	0.01	0.98	9.69	1.45	1.55	1.56
1300	3.29	3.28	0.01	1.03	10.42	1.41	1.51	1.52
1350	3.27	3.26	0.01	1.08	11.21	1.37	1.47	1.47
1400	3.26	3.24	0.02	1.13	12.09	1.33	1.42	1.42
1450	3.25	3.22	0.03	1.24	13.09	1.29	1.37	1.37
1500	3.24	3.21	0.03	1.27	14.19	1.26	1.32	1.32
1550	3.23	3.20	0.03	1.28	15.52	1.21	1.27	1.27
1600	3.22	3.19	0.03	1.40	17.11	1.17	1.22	1.22
1650	3.22	3.18	0.04	1.40	19.00	1.13	1.18	1.17
1700	3.21	3.17	0.04	1.49	21.34	1.10	1.13	1.12
1750	3.21	3.17	0.04	1.54	24.64	1.07	1.08	1.08
1800	3.22	3.18	0.04	1.61	30.07	1.06	1.05	1.04
1850	3.23	3.18	0.05	1.66	43.87	1.08	1.03	1.04
1900	3.24	3.19	0.05	1.66	32.99	1.12	1.06	1.07
1950	3.26	3.20	0.06	1.77	26.36	1.17	1.10	1.11
2000	3.28	3.23	0.05	1.81	22.82	1.22	1.15	1.16
2050	3.32	3.27	0.05	1.91	20.30	1.29	1.21	1.21
2100	3.36	3.31	0.05	2.03	18.34	1.37	1.26	1.26
2150	3.41	3.36	0.05	2.14	16.81	1.44	1.31	1.31
2200	3.47	3.41	0.06	2.27	15.57	1.52	1.37	1.36
2250	3.55	3.48	0.07	2.39	14.45	1.63	1.44	1.41
2300	3.63	3.56	0.07	2.54	13.49	1.73	1.50	1.47
2350	3.72	3.64	0.08	2.70	12.69	1.84	1.57	1.54
2360	3.75	3.66	0.09	2.67	12.53	1.87	1.58	1.54
2370	3.77	3.69	0.08	2.71	12.37	1.90	1.60	1.56
2380	3.79	3.71	0.08	2.74	12.23	1.92	1.62	1.57
2390	3.81	3.72	0.09	2.79	12.12	1.96	1.63	1.59
2400	3.83	3.75	0.08	2.81	11.94	1.99	1.64	1.59
2450	3.96	3.86	0.10	2.98	11.23	2.14	1.72	1.67
2500	4.09	3.98	0.11	3.16	10.65	2.29	1.80	1.75
2550	4.23	4.12	0.11	3.31	10.12	2.46	1.88	1.83
2560	4.27	4.15	0.12	3.34	10.00	2.50	1.90	1.84
2570	4.30	4.18	0.12	3.30	9.89	2.54	1.92	1.85
2580	4.34	4.21	0.13	3.33	9.79	2.58	1.93	1.86
2590	4.37	4.25	0.12	3.39	9.70	2.62	1.95	1.88
2600	4.40	4.28	0.12	3.43	9.60	2.67	1.96	1.90
2650	4.60	4.45	0.15	3.67	9.14	2.90	2.07	1.99
2660	4.64	4.49	0.15	3.69	9.05	2.95	2.09	2.01
2670	4.69	4.53	0.16	3.69	8.96	2.99	2.12	2.02
2680	4.73	4.57	0.16	3.68	8.88	3.05	2.14	2.04
2690	4.77	4.61	0.16	3.71	8.80	3.10	2.15	2.06
2700	4.81	4.64	0.17	3.76	8.73	3.15	2.17	2.09
2750	5.03	4.85	0.18	3.87	8.35	3.43	2.27	2.19
2800	5.28	5.07	0.21	4.07	8.00	3.73	2.38	2.29
2850	5.51	5.30	0.21	4.23	7.71	4.07	2.51	2.40
2900	5.79	5.54	0.25	4.31	7.46	4.44	2.66	2.54
2950	6.05	5.80	0.25	4.42	7.24	4.83	2.78	2.66
3000	6.35	6.07	0.28	4.68	7.03	5.28	2.92	2.79

<sup>1</sup>Total Loss = Insertion Loss + 3dB Splitter Loss

REV. X2  
BP2P1+  
100623  
Page 2 of 3



IF/RF MICROWAVE COMPONENTS • ISO 9001 ISO 14001 AS 9100 CERTIFIED • RoHS compliant  
P.O. Box 350166, Brooklyn, New York 11235-0003 (718) 934-4500 Fax (718) 332-4661



The Design Engineers Search Engine finds the model you need, Instantly • For detailed performance specs & shopping online see



# 2 Way-0° Power Splitter/Combiner

# BP2P1+

## Typical Performance Data

TEST CONDITIONS: INPUT POWER = 0dBm @Temperature = +85°C

FREQ. (MHz)	TOTAL LOSS <sup>1</sup> (dB)		AMP. UNBAL. (dB)	PHASE UNBAL. (deg.)	ISOLATION (dB)	VSWR (:1)		
	S-1	S-2				S	1	2
1000	3.56	3.55	0.01	1.01	7.40	1.58	1.69	1.69
1050	3.55	3.54	0.01	1.05	7.85	1.55	1.66	1.66
1100	3.54	3.53	0.01	1.08	8.37	1.52	1.64	1.64
1150	3.54	3.52	0.02	1.19	8.92	1.49	1.61	1.61
1200	3.54	3.51	0.03	1.19	9.54	1.46	1.57	1.57
1250	3.52	3.50	0.02	1.24	10.22	1.42	1.54	1.54
1300	3.51	3.48	0.03	1.25	10.98	1.39	1.51	1.50
1350	3.50	3.47	0.03	1.27	11.82	1.35	1.46	1.46
1400	3.49	3.46	0.03	1.32	12.78	1.31	1.42	1.42
1450	3.48	3.45	0.03	1.42	13.86	1.28	1.38	1.38
1500	3.48	3.44	0.04	1.47	15.10	1.23	1.34	1.34
1550	3.47	3.44	0.03	1.48	16.57	1.19	1.29	1.30
1600	3.46	3.43	0.03	1.60	18.29	1.15	1.25	1.26
1650	3.46	3.43	0.03	1.65	20.43	1.11	1.21	1.22
1700	3.47	3.43	0.04	1.77	23.24	1.07	1.16	1.18
1750	3.48	3.43	0.05	1.84	27.20	1.03	1.12	1.14
1800	3.49	3.44	0.05	1.95	33.46	1.03	1.08	1.09
1850	3.51	3.46	0.05	2.04	35.74	1.07	1.05	1.06
1900	3.53	3.47	0.06	2.08	28.99	1.12	1.05	1.05
1950	3.56	3.49	0.07	2.20	24.76	1.18	1.09	1.08
2000	3.59	3.53	0.06	2.24	21.86	1.24	1.13	1.12
2050	3.64	3.57	0.07	2.33	19.74	1.31	1.19	1.17
2100	3.69	3.61	0.08	2.47	18.08	1.38	1.24	1.22
2150	3.76	3.68	0.08	2.53	16.73	1.47	1.30	1.29
2200	3.83	3.75	0.08	2.59	15.58	1.56	1.37	1.35
2250	3.92	3.83	0.09	2.66	14.57	1.66	1.44	1.42
2300	4.02	3.93	0.09	2.81	13.69	1.77	1.51	1.50
2350	4.13	4.03	0.10	2.91	12.93	1.90	1.59	1.58
2360	4.16	4.06	0.10	2.91	12.77	1.92	1.61	1.59
2370	4.19	4.09	0.10	2.90	12.61	1.95	1.62	1.61
2380	4.21	4.12	0.09	2.91	12.48	1.98	1.64	1.63
2390	4.23	4.14	0.09	2.98	12.37	2.01	1.65	1.65
2400	4.26	4.16	0.10	2.99	12.23	2.04	1.67	1.67
2450	4.40	4.30	0.10	3.16	11.61	2.19	1.76	1.76
2500	4.55	4.45	0.10	3.31	11.04	2.36	1.85	1.86
2550	4.73	4.62	0.11	3.44	10.52	2.55	1.95	1.96
2560	4.76	4.65	0.11	3.48	10.43	2.58	1.97	1.98
2570	4.81	4.69	0.12	3.47	10.33	2.62	2.00	1.99
2580	4.85	4.73	0.12	3.48	10.23	2.66	2.02	2.01
2590	4.89	4.76	0.13	3.47	10.15	2.70	2.04	2.03
2600	4.91	4.80	0.11	3.55	10.06	2.74	2.06	2.06
2650	5.11	4.99	0.12	3.67	9.64	2.95	2.17	2.17
2660	5.14	5.03	0.11	3.72	9.57	3.00	2.19	2.20
2670	5.19	5.07	0.12	3.76	9.50	3.04	2.21	2.22
2680	5.24	5.12	0.12	3.74	9.41	3.08	2.24	2.23
2690	5.28	5.16	0.12	3.74	9.33	3.14	2.26	2.25
2700	5.32	5.21	0.11	3.82	9.27	3.19	2.28	2.28
2750	5.55	5.43	0.12	3.97	8.91	3.43	2.39	2.39
2800	5.79	5.66	0.13	4.18	8.59	3.70	2.52	2.51
2850	6.02	5.90	0.12	4.35	8.27	4.01	2.64	2.61
2900	6.29	6.16	0.13	4.55	7.99	4.32	2.76	2.73
2950	6.57	6.45	0.12	4.88	7.75	4.64	2.88	2.84
3000	6.86	6.72	0.14	5.09	7.47	4.99	3.00	2.94

<sup>1</sup>Total Loss = Insertion Loss + 3dB Splitter Loss

REV. X2  
BP2P1+  
100623  
Page 3 of 3



IF/RF MICROWAVE COMPONENTS • ISO 9001 ISO 14001 AS 9100 CERTIFIED RoHS compliant

P.O. Box 350166, Brooklyn, New York 11235-0003 (718) 934-4500 Fax (718) 332-4661



The Design Engineers Search Engine finds the model you need, Instantly • For detailed performance specs & shopping online see



# 2 Way-0° Power Splitter/Combiner

# BP2P1+

## Typical Performance Curves

### Total Loss

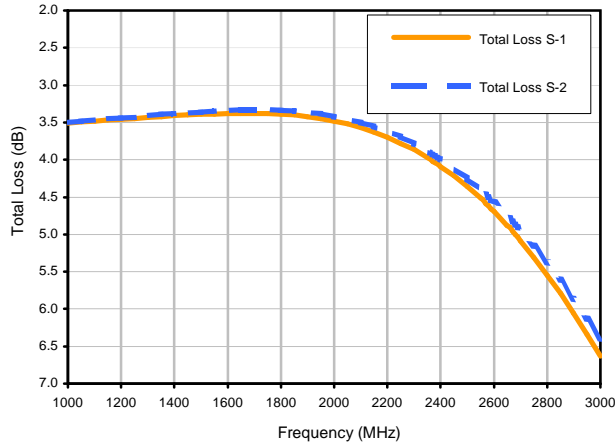

### Total Loss S-1 vs. TEMPERATURE

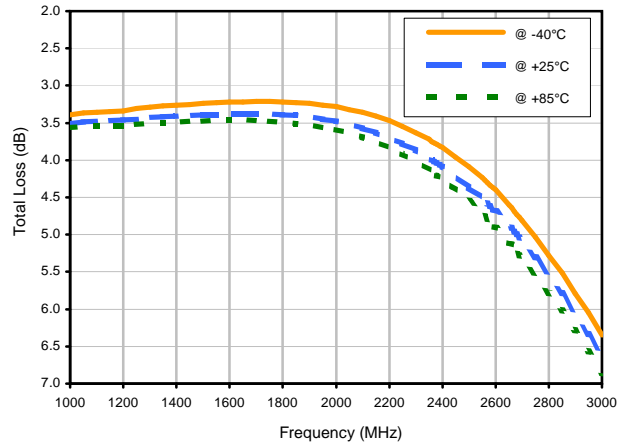

### Amplitude Unbalance vs. TEMPERATURE

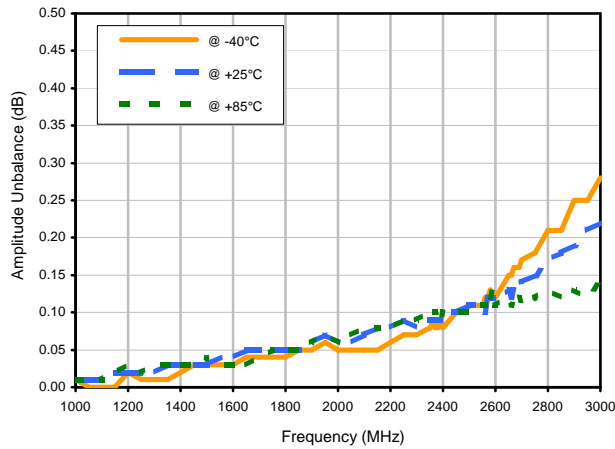

### Phase Unbalance vs. TEMPERATURE

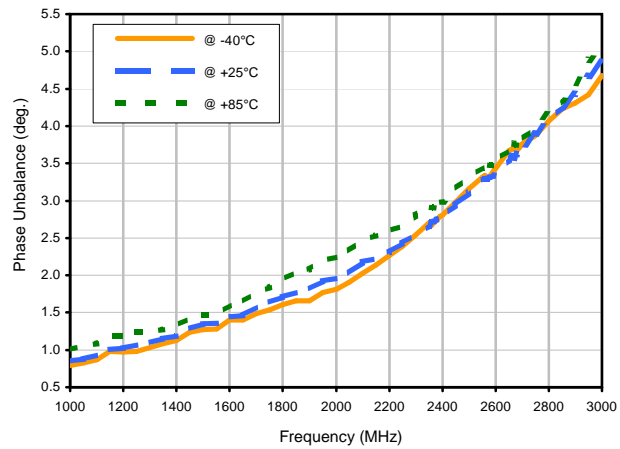

### Isolation 1-2 vs. TEMPERATURE

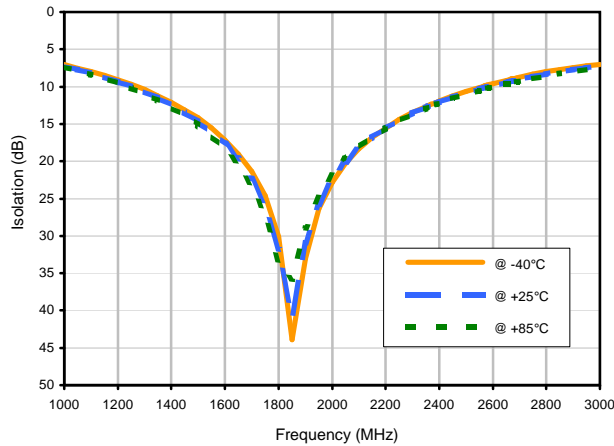

REV. X2  
BP2P1+  
100623  
Page 1 of 2



IF/RF MICROWAVE COMPONENTS • ISO 9001 ISO 14001 AS 9100 CERTIFIED RoHS compliant  
P.O. Box 350166, Brooklyn, New York 11235-0003 (718) 934-4500 Fax (718) 332-4661



The Design Engineers Search Engine finds the model you need, Instantly • For detailed performance specs & shopping online see [minicircuits.com](http://minicircuits.com)

## Typical Performance Curves

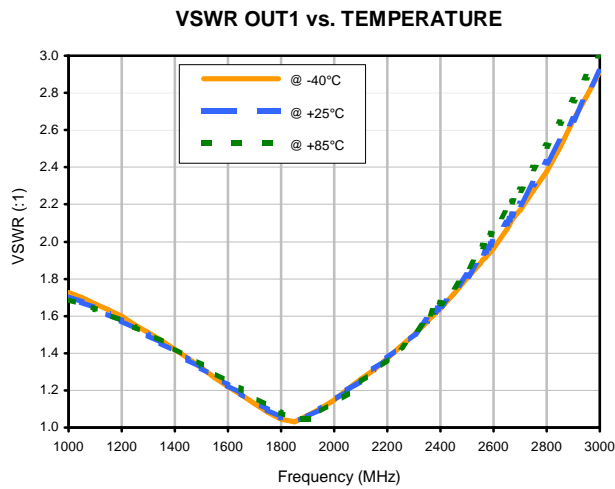
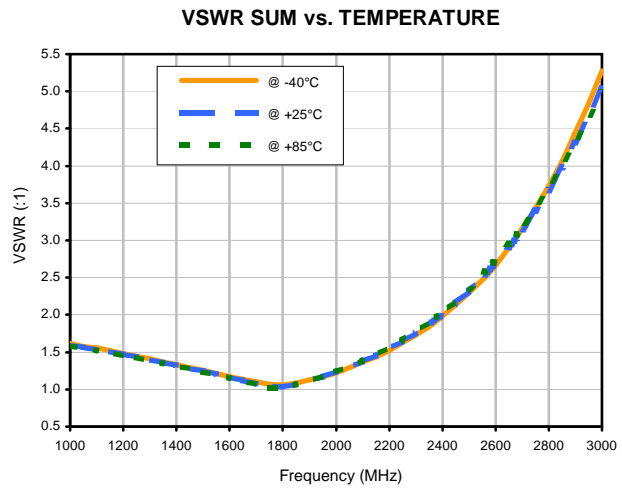
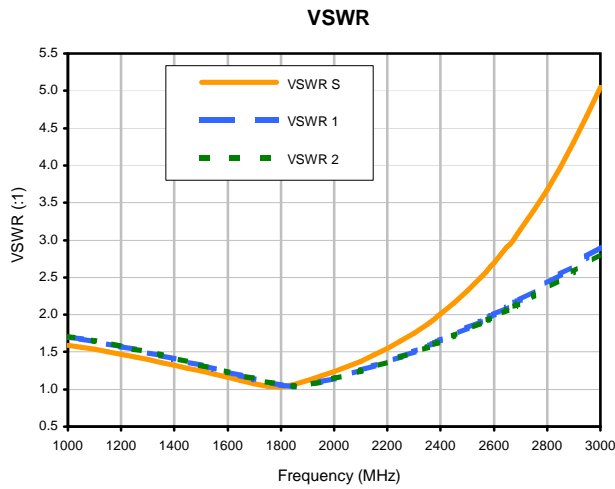

### Outline Dimensions

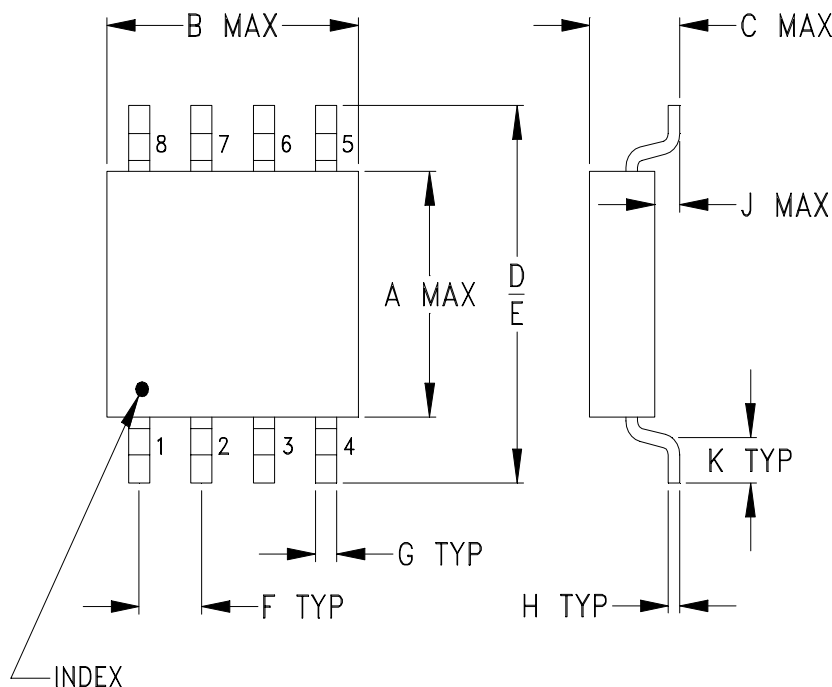

### PCB Land Pattern

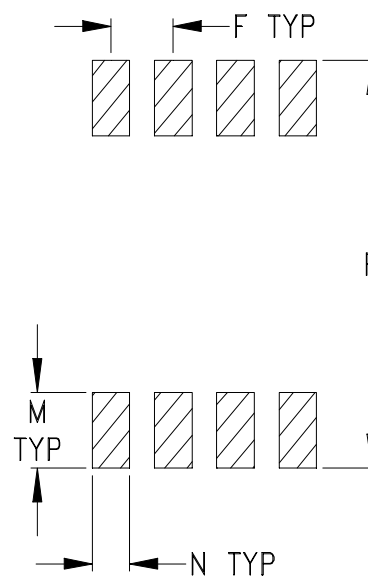

Suggested Layout,  
Tolerance to be within  $\pm .002$

CASE #	A	B	C	D	E	F	G	H	J	K	L	M	N	P
XX211	.163 (4.14)	.210 (5.33)	.077 (1.96)	.250 (6.35)	.220 (5.59)	.050 (1.27)	.017 (0.43)	.009 (0.23)	.025 (0.64)	.030 (0.76)	--	.050 (1.27)	.030 (0.76)	.270 (6.86)

CASE #	Q	R	S	WT. GRAM
XX211	--	--	--	.10

Dimensions are in inches (mm). Tolerances: 2 Pl.  $\pm .03$ ; 3 Pl.  $\pm .015$

#### Notes:

- Case material: Plastic.
  - Termination finish:  
For RoHS Case Styles: Tin-Silver alloy plate over Nickel barrier. All models, (+) suffix.  $\otimes$   
For RoHS-5 Case Styles: Tin-Lead plate. All models, No (+) suffix.
  - Special Tolerances: Termination width  $\pm .005$  inch, termination thickness  $\pm .003$  inch.
- $\otimes$  Model BP4C+ will be supplied with either Tin finish or Tin-Silver-Nickel finish until Tin finish inventory is depleted.



INTERNET <http://www.minicircuits.com>

P.O. Box 350166, Brooklyn, New York 11235-0003 (718) 934-4500 Fax (718) 332-4661

Distribution Centers NORTH AMERICA 800-654-7949 • 417-335-5935 • Fax 417-335-5945 • EUROPE 44-1252-832600 • Fax 44-1252-837010

Mini-Circuits ISO 9001 & ISO 14001 Certified

# Tape & Reel Packaging TR-F16

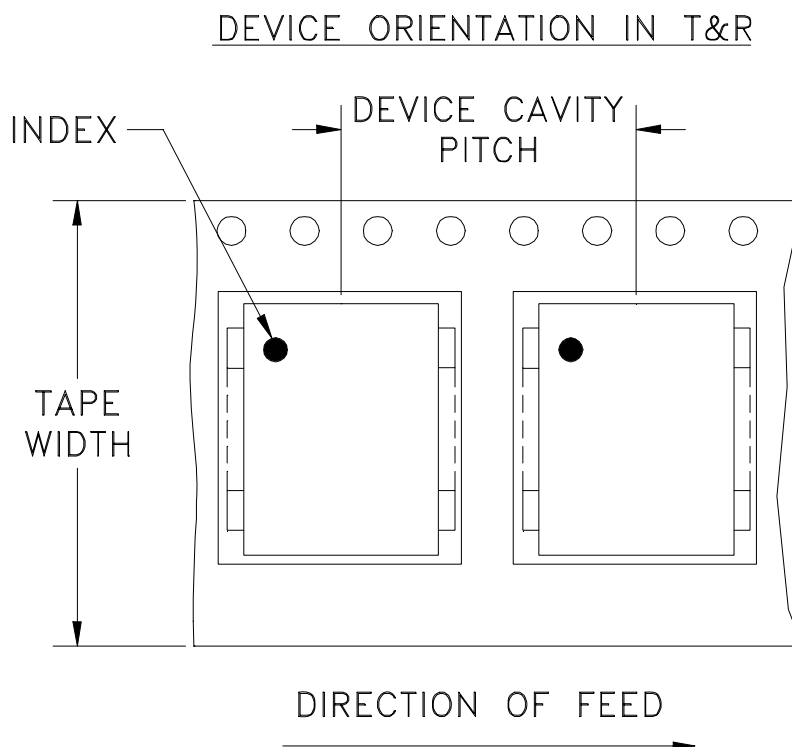

Tape Width, mm	Device Cavity Pitch, mm	Reel Size, inches	Devices per Reel	
12	8	7	Small quantity standards (see note)	20
				50
				100
				200
				500
		Standard	1000*	
		13	Standard	2000**

Note : Please Consult individual model data sheet to determine device per reel availability

\* BP models only

\*\* MSW and MSWA models

Mini-Circuits carrier tape materials provide protection from ESD (Electro-Static Discharge) during handling and transportation. Tapes are static dissipative and comply with industry standards EIA-481/EIA-541.

Go to: [www.minicircuits.com/pages/pdfs/tape.pdf](http://www.minicircuits.com/pages/pdfs/tape.pdf)



INTERNET <http://www.minicircuits.com>

P.O. Box 350166, Brooklyn, New York 11235-0003 (718) 934-4500 Fax (718) 332-4661

Distribution Centers NORTH AMERICA 800-654-7949 • 417-335-5935 • Fax 417-335-5945 • EUROPE 44-1252-832600 • Fax 44-1252-837010

Mini-Circuits ISO 9001 & ISO 14001 Certified



THIRD ANGLE PROJECTION

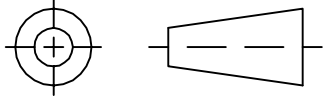

REVISIONS

REV	ECN No.	DESCRIPTION	DATE	DR	AUTH
OR	M82272	NEW RELEASE	08/06/02	GF	DJ
A	M102713	UPDATED NOTES, ADDED "...WITH SMOBC"	01/16/06	GT	IL

SUGGESTED MOUNTING CONFIGURATION FOR XX211 CASE STYLE, "jm" PIN CONNECTION

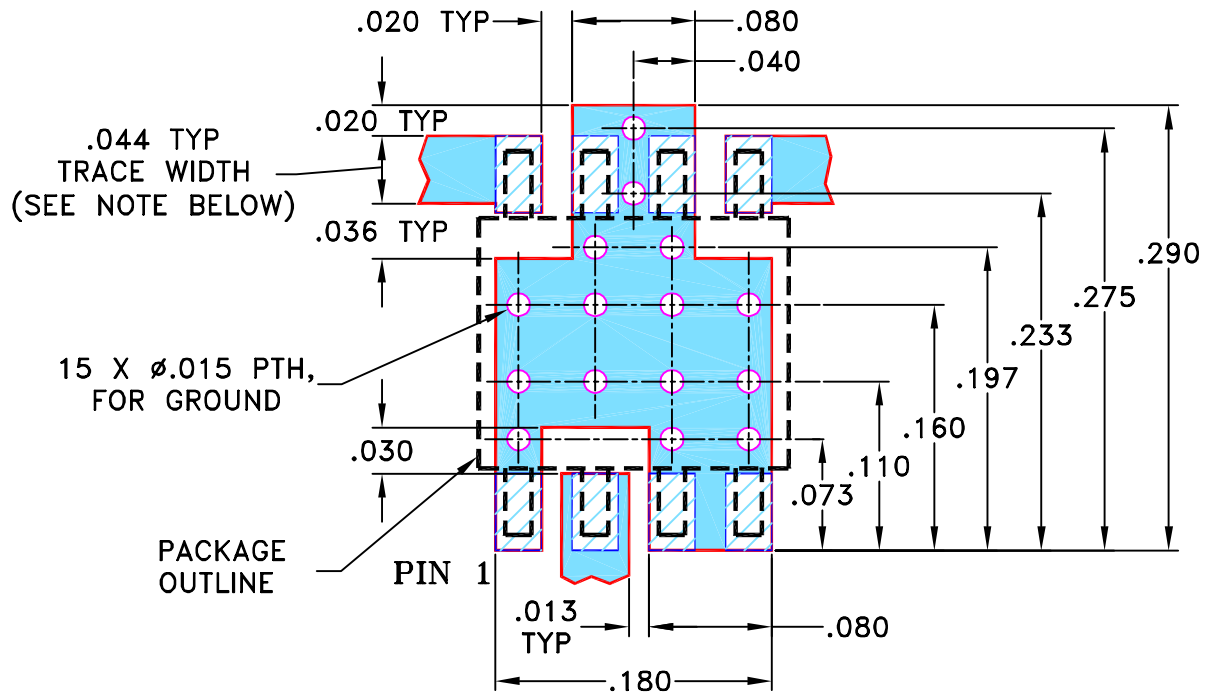

- NOTES: 1. TRACE WIDTH IS SHOWN FOR ROGERS R04350B WITH DIELECTRIC THICKNESS 0.020" ± 0.0015". COPPER: 1/2 OZ. EACH SIDE. FOR OTHER MATERIALS TRACE WIDTH MAY NEED TO BE MODIFIED.
2. BOTTOM SIDE OF THE PCB IS CONTINUOUS GROUND PLANE.

- DENOTES PCB COPPER LAYOUT WITH SMOBC (SOLDER MASK OVER BARE COPPER)
- DENOTES COPPER LAND PATTERN FREE OF SOLDER MASK

UNLESS OTHERWISE SPECIFIED	INITIALS	DATE
DRAWN	GF	07/17/02
CHECKED	HY	08/06/02
APPROVED	DJ	08/06/02

**Mini-Circuits**<sup>®</sup> 13 Neptune Avenue  
Brooklyn NY 11235

PL, jm, XX211, BP2, TB-37

THIS DOCUMENT AND ITS CONTENTS ARE THE PROPERTY OF MINI-CIRCUITS. EXCEPT FOR USE EXPRESSLY GRANTED, IN WRITING, TO ITS VENDORS, VENDEE AND THE UNITED STATES GOVERNMENT, MINI-CIRCUITS RESERVES ALL PROPRIETARY DESIGN, USE, MANUFACTURING AND REPRODUCTION RIGHTS THERETO. THESE CONTENTS SHALL NOT BE USED, DUPLICATED OR DISCLOSED TO ANY OUTSIDE PARTY, IN WHOLE OR IN PART, WITHOUT WRITTEN PERMISSION OF MINI-CIRCUITS.

SIZE A	CODE IDENT 15542	DRAWING NO: 98-PL-053	REV: A
FILE: 98PL053	SCALE: 8:1	SHEET: 1 OF 1	

# Evaluation Board and Circuit

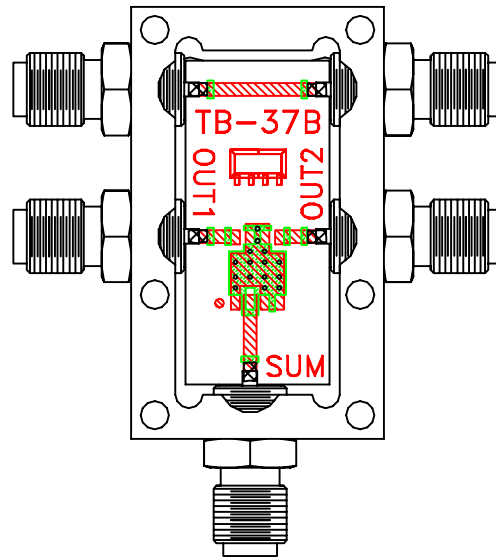

TB-37

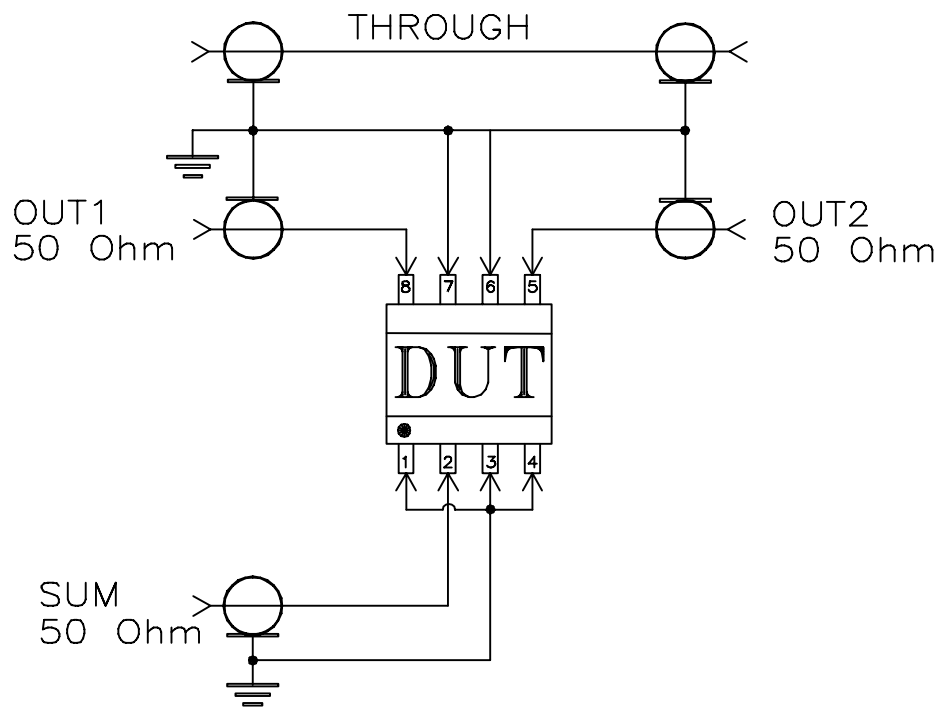

Schematic Diagram

## Notes:

1. SMA Female connectors.
2. PCB Material: Rogers R04350 or equivalent, Dielectric Constant=3.5, Thickness=.020 inch.

 Mini-Circuits®

All Mini-Circuits products are manufactured under exacting quality assurance and control standards, and are capable of meeting published specifications after being subjected to any or all of the following physical and environmental test.

Specification	Test/Inspection Condition	Reference/Spec
Operating Temperature	-40° to 85° C Ambient Environment	Individual Model Data Sheet
Storage Temperature	-65° to 150° C Ambient Environment	Individual Model Data Sheet
Autoclave	15 psig, 100% RH, 121°C, 96 hours	JESD22-A102-C, Condition C
Temperature Cycling	-65° to 150°C, 100 cycles	JESD22-A104
Temperature Humidity	85°C/ 85% RH, 168 hours	JESD22-113
Solder Reflow Heat	Sn-Pb Eutetic Process: 240°C peak Pb-Free Process: 260°C peak	J-STD-020, Table 4-1, 4-2 and 5-2; Figure 5-1
Moisture Sensitivity: Level 1	Bake at 125°C for 24 hours Soak at 85°C/85% RH for 168 hours, Reflow 3 cycles at 240°C peak (Non-RoHS) or 260°C (RoHS)	J-STD-020
Solderability	10X magnification, 95% coverage	JESD22-B102, Method 1: Dip and Look Test
Mechanical Shock	50g, 11 ms, 1/2-sine, 18 shocks: 3 each direction, each of 3 axes	MIL-STD-202, Method 213, Condition A
Vibration (High Frequency)	20g peak, 10-2000 Hz, 12 times in each of three perpendicular directions (total 36)	MIL-STD-202, Method 204, Condition D