

Ceramic Balun RF Transformer

50Ω 4900 to 5950 MHz 1:2 Ratio

BLNK2-542R+



Generic photo used for illustration purposes only
CASE STYLE: NK0402C

+RoHS Compliant
The +Suffix identifies RoHS Compliance. See our web site for RoHS Compliance methodologies and qualifications

Available Tape and Reel at no extra cost
Reel Size 7" Devices/Reel 20, 50, 100, 200, 500, 1000, 4000

Maximum Ratings

Operating Temperature	-40°C to 85°C
Storage Temperature*	-40°C to 85°C
Input RF Power**	2W at 25°C

*Refer to product storage temperature after installation.
Suggestion for T&R unused product storage condition: +5--+35°C, Humidity 45-75%RH, 12 Month max.
Permanent damage may occur if any of these limits are exceeded.
**Derate linearly to 1W at 85°C.

Pad Connections

PRIMARY DOT (Unbalanced Port)	1
PRIMARY (GND)	4
SECONDARY DOT (Balanced)	2
SECONDARY (Balanced)	3

Outline Drawing

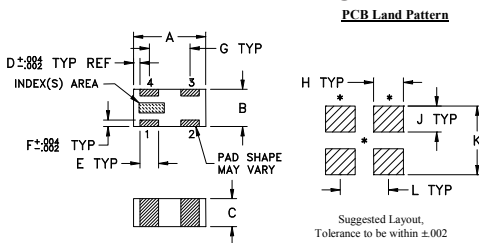

Outline Dimensions (inch/mm)

A	B	C	D	E	F	G	H	
.039	.020	.015	.004	.010	.004	.022	.016	
1.0	0.51	0.38	0.10	0.25	0.10	0.56	0.41	
J	K	L						wt
.014	.037	.026						grams
0.36	0.94	0.66						.0007

Evaluation Board MCL P/N: TB-1012-2542+ Suggested PCB Layout (PL-624)

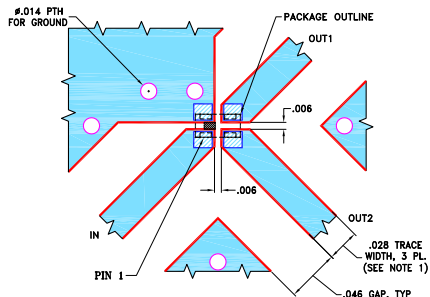

Notes

- Performance and quality attributes and conditions not expressly stated in this specification document are intended to be excluded and do not form a part of this specification document.
- Electrical specifications and performance data contained in this specification document are based on Mini-Circuit's applicable established test performance criteria and measurement instructions.
- The parts covered by this specification document are subject to Mini-Circuits standard limited warranty and terms and conditions (collectively, "Standard Terms"); Purchasers of this part are entitled to the rights and benefits contained therein. For a full statement of the Standard Terms and the exclusive rights and remedies thereunder, please visit Mini-Circuits' website at www.minicircuits.com/MCLStore/terms.jsp

Features

- miniature size 0402 (0.039"[1.0mm] x 0.020"[0.5mm] x 0.015"[0.37mm])
- low phase unbalance, 2.4 deg.
- LTCC construction
- low cost
- aqueous washable

Applications

- ISM Band
- WLAN/Wi-Fi
- Bluetooth
- Zigbee

Electrical Specifications at 25°C

Parameter	Frequency (MHz)	Min.	Typ.	Max.	Unit
Impedance Ratio			2		
Frequency Range		4900	—	5950	MHz
Insertion Loss*	4900 - 5950	—	0.5	1	dB
Amplitude Unbalance	4900 - 5950	—	0.7	2	dB
Phase Unbalance†	4900 - 5950	—	2.4	10	Degree
Unbalance Return Loss	4900 - 5950	9.5	24	—	dB

* Tested on Evaluation Board TB-1012-2542+

† Relative to 180°

Typical Performance Data at 25°C**

FREQUENCY (GHz)	INSERTION LOSS (dB)	INPUT R. LOSS (dB)	AMPLITUDE UNBALANCE (dB)	PHASE UNBALANCE (Deg.)
4.90	0.59	29.97	1.04	2.12
5.00	0.58	28.53	0.93	1.46
5.10	0.56	27.81	0.84	0.77
5.20	0.55	27.37	0.76	0.02
5.30	0.54	27.48	0.70	0.75
5.40	0.52	28.64	0.63	1.57
5.50	0.51	30.71	0.58	2.45
5.60	0.49	35.37	0.52	3.23
5.70	0.48	48.32	0.51	3.94
5.80	0.46	35.88	0.49	4.85
5.95	0.45	26.97	0.46	6.01

** Measured with Agilent E5071B network analyzer using impedance conversion and port extension.

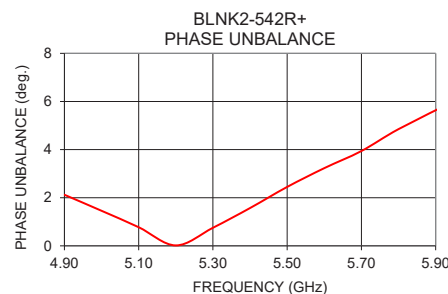
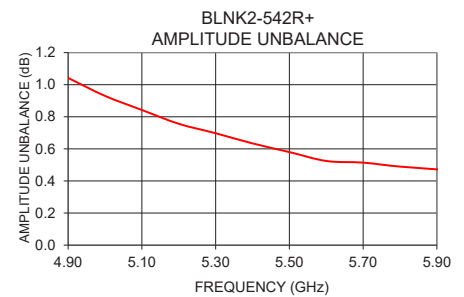
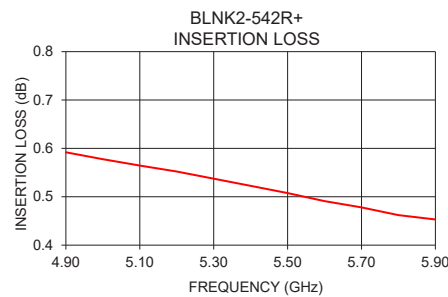

Configuration G

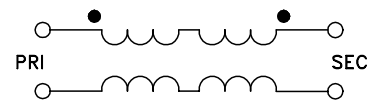

Typical Performance Data

FREQUENCY (MHz)	AVERAGE INSERTION LOSS (dB)	INPUT RETURN LOSS (dB)	AMPLITUDE UNBALANCE (dB)	PHASE UNBALANCE ⁽¹⁾ (deg.)
4900	0.59	29.97	1.04	2.12
4925	0.59	29.65	1.02	1.99
4950	0.59	29.35	0.98	1.86
4975	0.58	29.03	0.96	1.66
5000	0.58	28.53	0.93	1.46
5025	0.58	28.15	0.91	1.27
5050	0.57	27.87	0.88	1.12
5075	0.57	27.75	0.86	0.97
5100	0.56	27.81	0.84	0.77
5125	0.56	27.68	0.82	0.57
5150	0.56	27.46	0.80	0.40
5175	0.55	27.27	0.78	0.18
5200	0.55	27.37	0.76	0.02
5225	0.55	27.53	0.74	0.16
5250	0.54	27.53	0.72	0.39
5275	0.54	27.41	0.71	0.58
5300	0.54	27.48	0.70	0.75
5325	0.53	27.85	0.68	1.00
5350	0.53	28.16	0.65	1.18
5375	0.53	28.39	0.64	1.40
5400	0.52	28.64	0.63	1.57
5425	0.52	29.15	0.63	1.76
5450	0.52	29.88	0.61	2.01
5475	0.51	30.40	0.59	2.26
5500	0.51	30.71	0.58	2.45
5525	0.50	31.10	0.57	2.63
5550	0.50	32.16	0.55	2.81
5575	0.50	33.65	0.54	3.05
5600	0.49	35.37	0.52	3.23
5625	0.49	37.17	0.53	3.38
5650	0.48	38.97	0.52	3.55
5675	0.48	42.19	0.51	3.75
5700	0.48	48.32	0.51	3.94
5725	0.47	47.58	0.51	4.20
5750	0.47	42.15	0.50	4.42
5775	0.47	38.71	0.50	4.63
5800	0.46	35.88	0.49	4.85
5825	0.46	33.65	0.49	5.05
5850	0.46	31.65	0.49	5.32
5875	0.46	30.31	0.48	5.52
5900	0.45	29.15	0.47	5.69
5950	0.45	26.97	0.46	6.01

⁽¹⁾ Relative to 180°

LTCC Balun
RF Transformer

BLNK2-542R+

Typical Performance Data

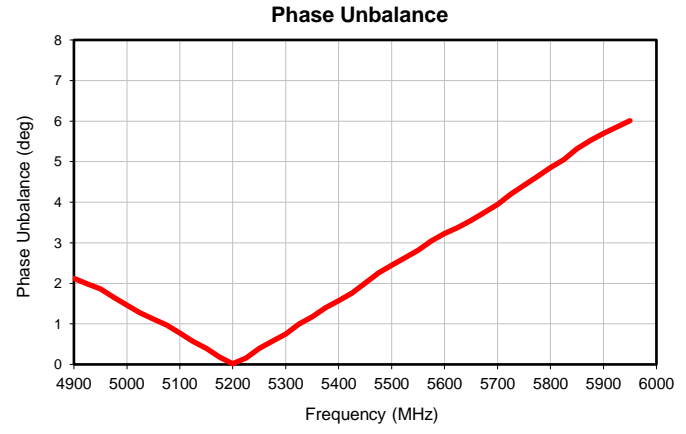
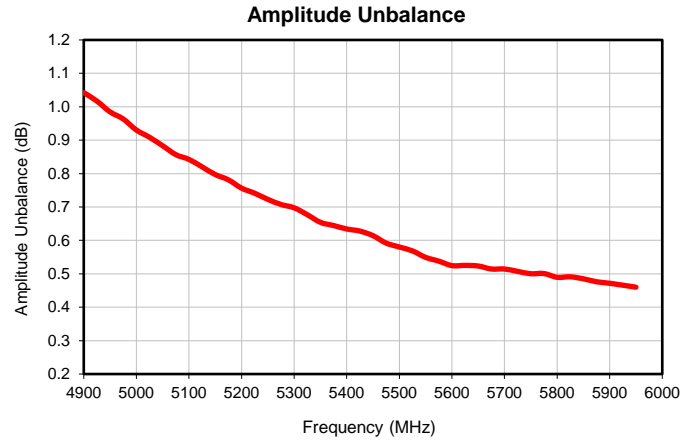
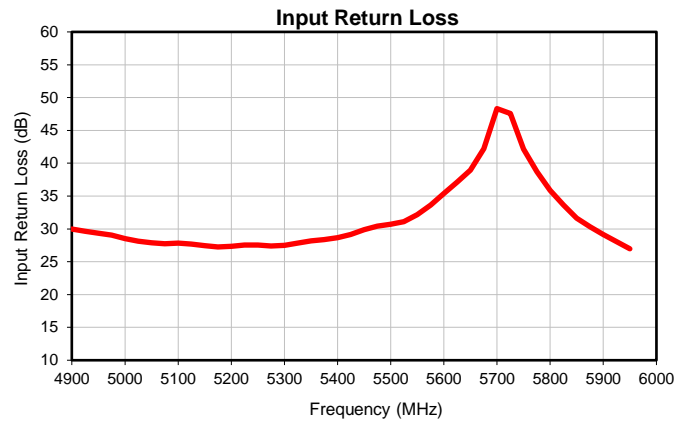
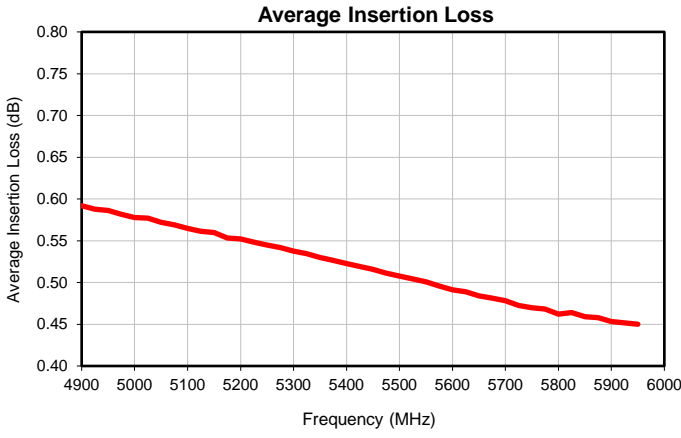

P.O. Box 350166, Brooklyn, New York 11235-0003 (718) 934-4500 • Fax (718) 332-4661 For detailed performance specs & shopping online see Mini-Circuits web site
 The Design Engineers Search Engine Provides ACTUAL Data Instantly From MINI-CIRCUITS At: www.minicircuits.com

REV. OR
 BLNK2-542R+
 5/10/2019
 Page 1 of 1

Outline Dimensions

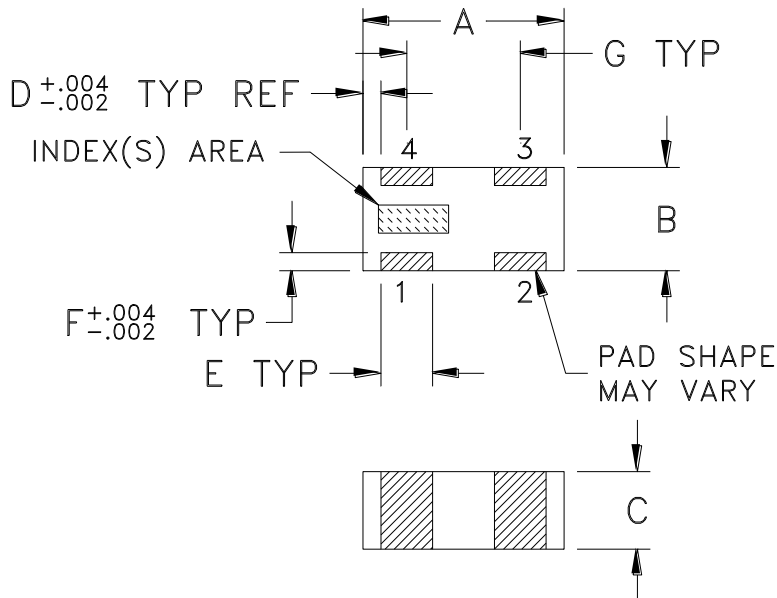

PCB Land Pattern

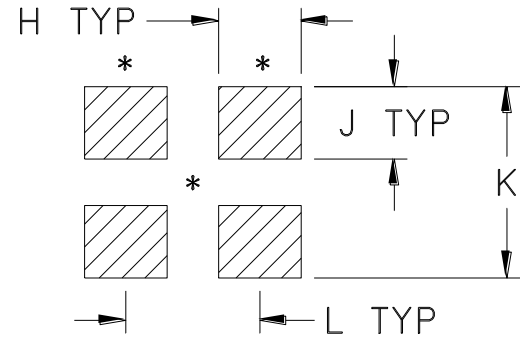

Suggested Layout,
Tolerance to be within $\pm .002$

CASE#	A	B	C	D	E	F	G	H	J	K	L	WT.GRAMS
NK0402C	.039 (1.00)	.020 (.50)	.015 (0.37)	.004 (0.10)	.010 (0.25)	.004 (0.10)	.022 (0.55)	.016 (0.41)	.014 (0.36)	.037 (0.94)	.026 (0.65)	.0007

Dimensions are in inches (mm). Tolerances: 2 Pl. $\pm .01$; 3 Pl. $\pm .005$

Notes:

1. Open style, ceramic base.
2. Termination finish:
For RoHS Case Styles: Matte Tin over Nickel plating. Models with (+) suffix.
3. *Line width should be designed to match 50 Ω characteristic impedance, depending on PCB material and thickness.



P.O. Box 350166, Brooklyn, New York 11235-0003 (718) 934-4500 Fax (718) 332-4661 For detailed performance specs & shopping online see Mini-Circuits web site



The Design Engineers Search Engine Provides ACTUAL Data Instantly From MINI-CIRCUITS At: www.minicircuits.com

RF/IF MICROWAVE COMPONENTS

THIRD ANGLE PROJECTION

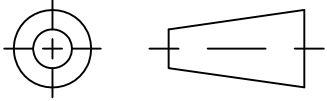

REVISIONS

REV	ECN No.	DESCRIPTION	DATE	DR	AUTH
OR	M173420	NEW RELEASE	03/26/19	ITG	SL

SUGGESTED MOUNTING CONFIGURATION
FOR NK0402C CASE STYLE, "04TG01" PIN CODE

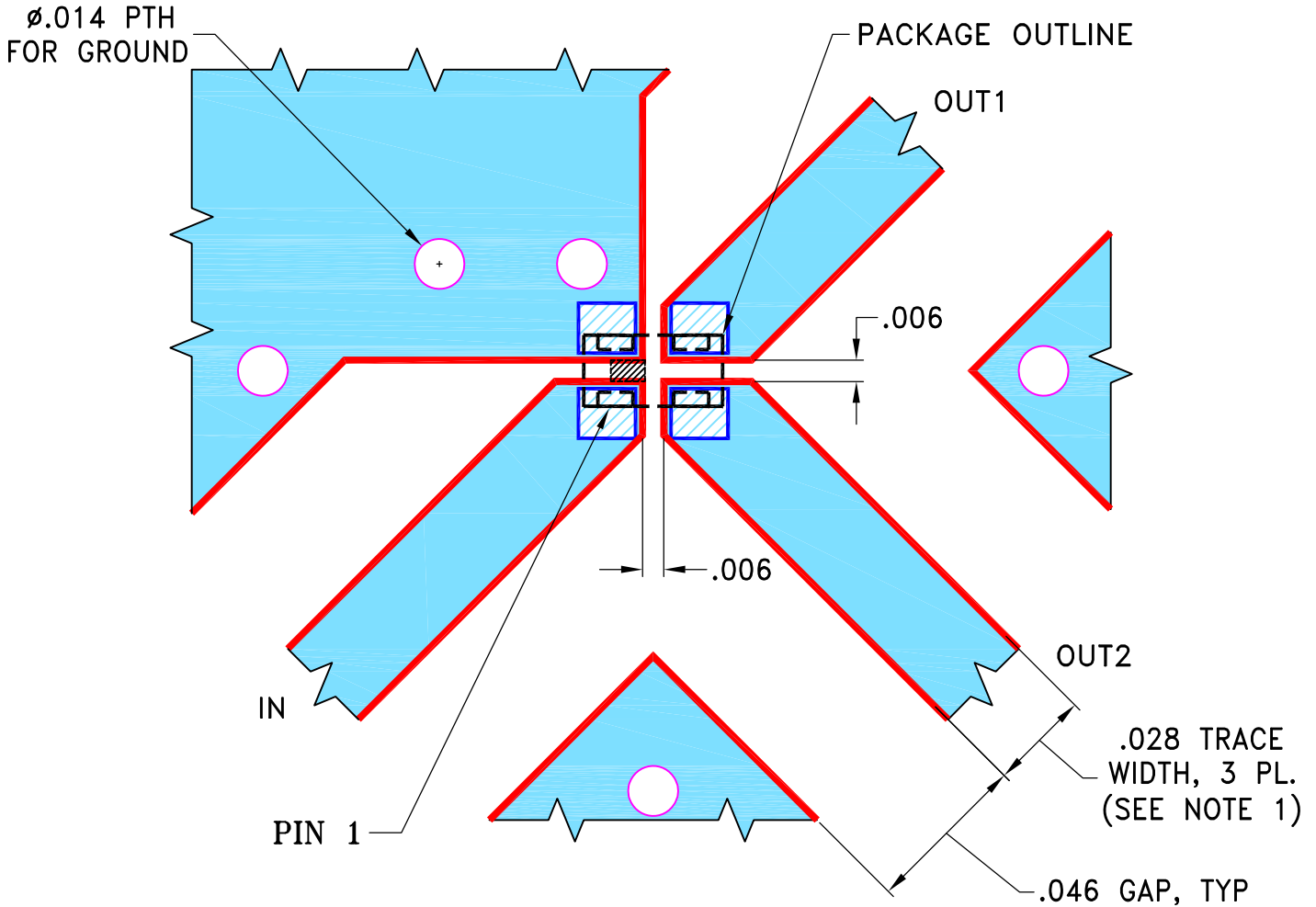

NOTES:

- TRACE WIDTH & GAP ARE SHOWN FOR FR4, GRADE IT-180TC (ITEQ CORP.) WITH DIELECTRIC THICKNESS $.016 \pm .0015$. COPPER: 1/2 OZ. EACH SIDE. FOR OTHER MATERIALS TRACE WIDTH & GAP MAY NEED TO BE MODIFIED.
- BOTTOM SIDE OF THE PCB IS CONTINUOUS GROUND PLANE.

- DENOTES PCB COPPER LAYOUT WITH SMOBC (SOLDER MASK OVER BARE COPPER).
- DENOTES COPPER LAND PATTERN FREE OF SOLDER MASK.

UNLESS OTHERWISE SPECIFIED	INITIALS	DATE
DIMENSIONS ARE IN INCHES	DRAWN ITG	03/22/19
TOLERANCES ON:	CHECKED GF	03/22/19
2 PL DECIMALS \pm	APPROVED SL	03/26/19
3 PL DECIMALS \pm .005		
ANGLES \pm		
FRACTIONS \pm		

Mini-Circuits® 13 Neptune Avenue
Brooklyn NY 11235

PL, 04TG01, NK0402C, TB-1012-X542+

SIZE A	CODE IDENT 15542	DRAWING NO: 98-PL-624	REV: OR
FILE: 98PL624	SCALE: 20:1	SHEET: 1 OF 1	

Mini-Circuits®
THIS DOCUMENT AND ITS CONTENTS ARE THE PROPERTY OF MINI-CIRCUITS. EXCEPT FOR USE EXPRESSLY GRANTED, IN WRITING, TO ITS VENDORS, VENDEE AND THE UNITED STATES GOVERNMENT, MINI-CIRCUITS RESERVES ALL PROPRIETARY DESIGN, USE, MANUFACTURING AND REPRODUCTION RIGHTS THERETO. THESE CONTENTS SHALL NOT BE USED, DUPLICATED OR DISCLOSED TO ANY OUTSIDE PARTY, IN WHOLE OR IN PART, WITHOUT WRITTEN PERMISSION OF MINI-CIRCUITS.

Evaluation Board and Circuit

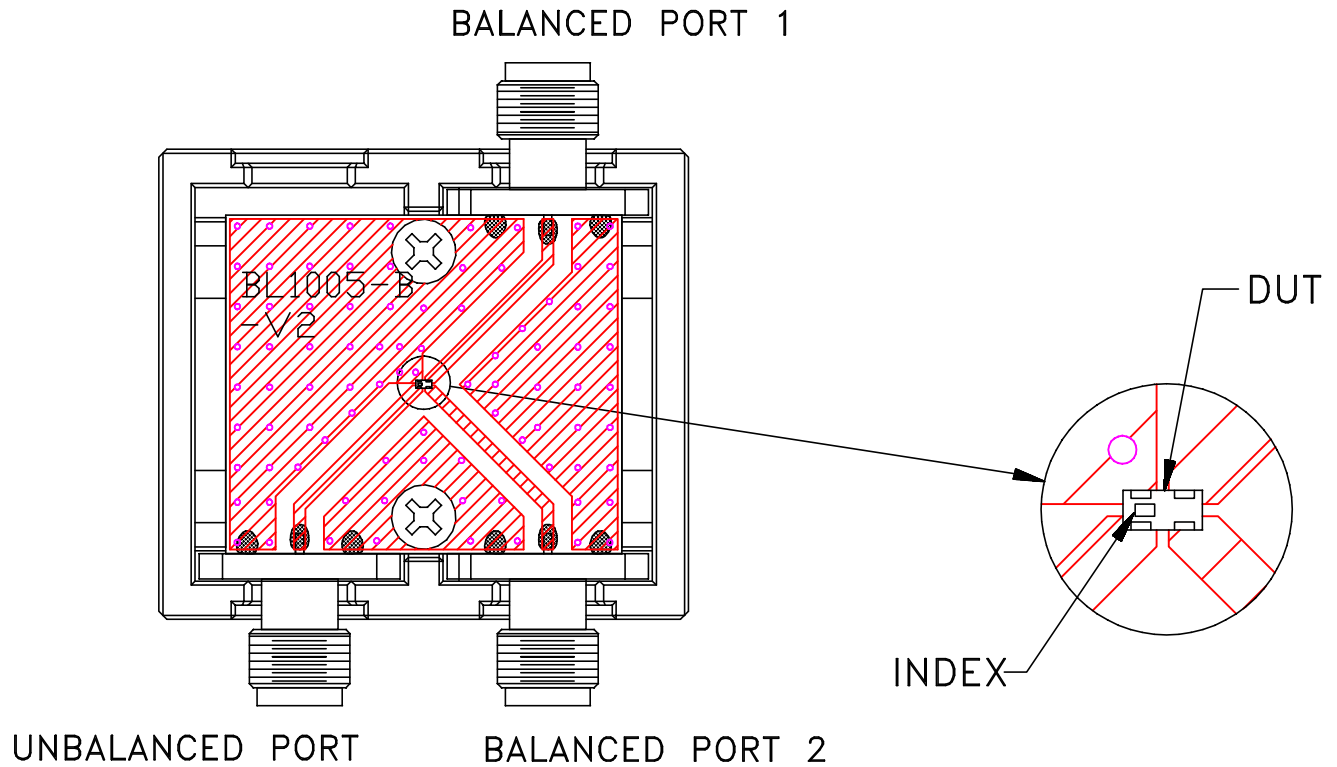

TB-1012-2542+

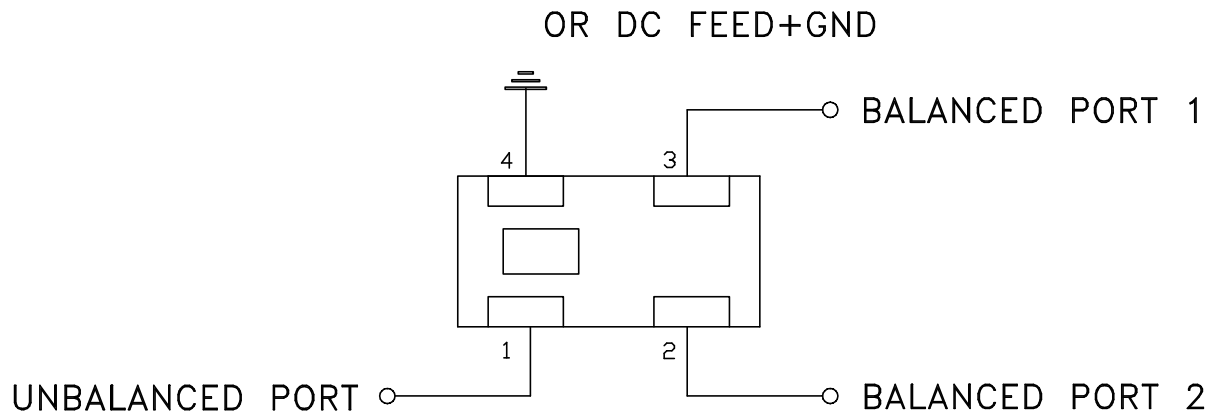

Schematic Diagram

Notes:

1. 50 Ohm SMA Female connectors.
2. PCB Material: FR4 or equivalent,
Dielectric Constant=4.5, Thickness=.016 inch.

 **Mini-Circuits®**



All Mini-Circuits products are manufactured under exacting quality assurance and control standards, and are capable of meeting published specifications after being subjected to any or all of the following physical and environmental test.

Specification	Test/Inspection Condition	Reference/Spec
Operating Temperature	-40° to 85° C Ambient Environment	Individual Model Data Sheet
Storage Temperature	-40° to 85° C Ambient Environment	Individual Model Data Sheet
Thermal Shock	-40° to 125°C, 100 cycles	MIL-STD-202 Method 107, Condition A-3 except -40°C instead of -55° C and +125° C instead of -85° C
Solder Reflow Heat	Pb-Free Process 245° -250°C peak,	J-STD-020, 4-2 and 5-2, Figure 5-1
Solderability	10X Magnification	J-STD-002, Para 4.2.5, Test S, 95% Coverage
Shelf Life	Shelf life is 12 months when kept in sealed bags. Unused parts are to be resealed to preserve shelf life for proper solderability.	