



LTCC SURFACE MOUNT

# Bandpass Filter

## BFHKI-2492+

50Ω 22 to 28 GHz

### THE BIG DEAL

- LTCC Band Pass Filter with Integrated Interposer Board
- Wide Stopband Rejection, Typ. 40 dB up to 67 GHz
- Small Size, 4.95 mm x 3.65 mm
- Shielded Construction
- Protected by US Patents 11,638,370 and 11,744,057



Generic photo used for illustration purposes only

### APPLICATIONS

- Test & Measurement Equipment
- Aerospace and Defense Signal Conditioning

### FUNCTIONAL DIAGRAM

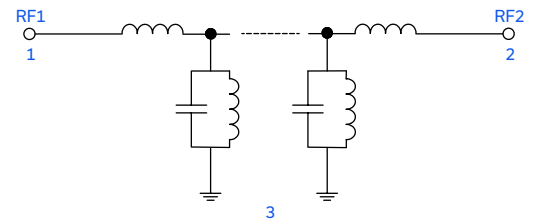

### PRODUCT OVERVIEW

BFHKI-2492+ is a miniature low-temperature co-fired ceramic (LTCC) ultra-high stopband rejection band pass filter with a 22 to 28 GHz passband that supports a variety of applications. This model achieves 40 dB typical stopband rejection up to 67 GHz when mounted on coplanar waveguide layouts. Housed in a small 4.95 mm by 3.65 mm ceramic form factor, the filter is ideal for dense signal chain PCB layouts where it complements MMIC size and performance. The BFHKI family with integrated interposer board enables installation onto PCB layouts with automated manufacturing equipment. This model provides a 3.3 dB typical insertion loss over a wide band due to its rugged monolithic construction. The LTCC fabrication process assures minimal RF performance variation while delivering a product that is well-suited for environmental extremes of high humidity and temperature.

### KEY FEATURES

Features	Advantages
Surface Mountable due to Integrated Interposer Board	Enables installation with automated manufacturing equipment, making this suitable for high-volume processes.
Wide Rejection	Provides high stopband rejection of 40 dB typical up to 67 GHz.
Small Size (4.95 x 3.65mm)	Allows for high layout density of circuit boards, while minimizing effects of parasitics.
Wide Operating and Storage Temperature (-55 to 125°C)	Enables use in high reliability and extreme environment conditions, such as in aerospace & defense applications.
Cost Effective	LTCC is a scalable technology that is cost-effective due to ease of production in high-volume.

REV. OR  
ECO-020866  
BFHKI-2492+  
MCL NY  
240220





### ELECTRICAL SPECIFICATIONS<sup>1,2,3</sup> AT +25°C

Parameter	F#	Frequency (GHz)	Min.	Typ.	Max.	Units
Center Frequency <sup>4</sup>	—	—	—	25	—	GHz
Passband	Insertion Loss	F2-F3	22 - 28	3.3	4.5	dB
	Return Loss	F2-F3	22 - 28	8	—	dB
Stopband, Lower	Rejection	DC-F1	0.1 - 16	40	50	dB
Stopband, Upper	Rejection	F4-F5	34 - 50	40	50	dB
			50 - 60	—	50	—
			60 - 67	—	40	dB

1. Tested on Evaluation Board P/N TB-BFHKI-2492C+. Measured with the connector and feedline effects de-embedded using the 2XThru IEEE P370 method.
2. Bi-directional, RF1 and RF2 ports can be interchanged.
3. This component should not be used as a DC block. In applications with DC voltage and/or current at either the input or output ports, external DC-blocking capacitors are required.
4. Typical variation ±3%.

### ABSOLUTE MAXIMUM RATINGS<sup>5</sup>

Parameter	Ratings
Operating Temperature	-55°C to +125°C
Storage Temperature	-55°C to +125°C
Input Power <sup>6</sup>	1 W

5. Permanent damage may occur if any of these limits are exceeded.
6. Power rating applies only to signals within the passband. Power rating above +25°C operating temperature decreases linearly to 0.5 W at +125°C.

### TYPICAL FREQUENCY RESPONSE AT +25°C

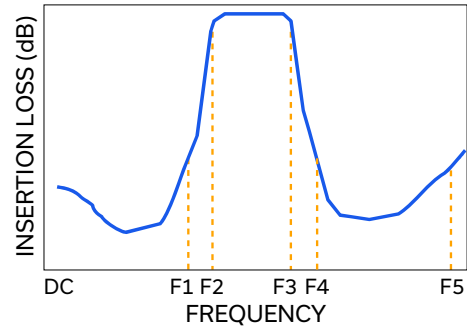



LTCC SURFACE MOUNT

# Bandpass Filter

**BFHKI-2492+**

Mini-Circuits

50Ω 22 to 28 GHz

## TYPICAL PERFORMANCE GRAPHS

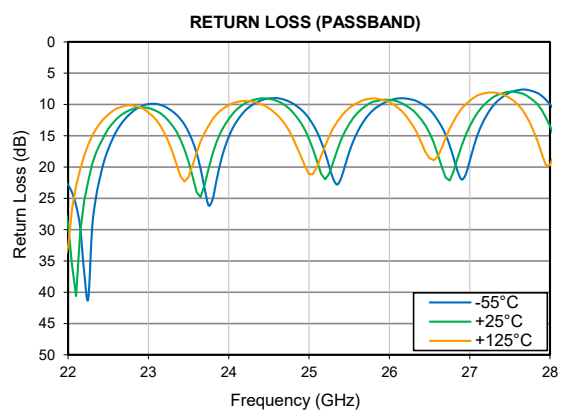
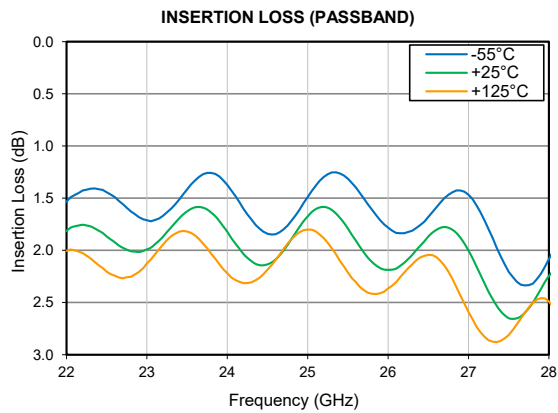
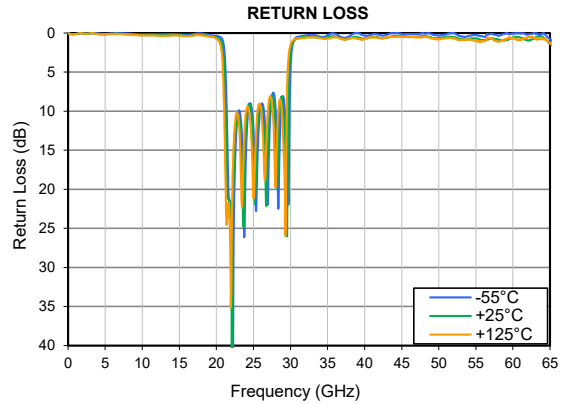
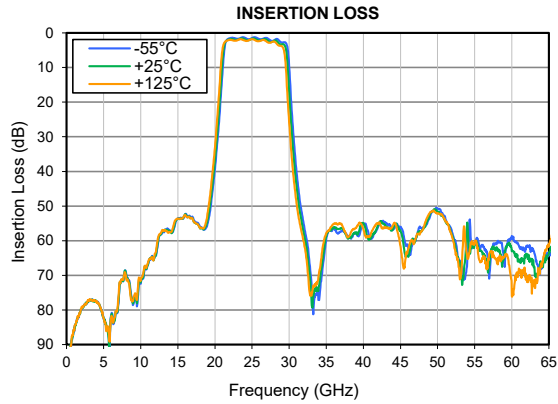



### FUNCTIONAL DIAGRAM

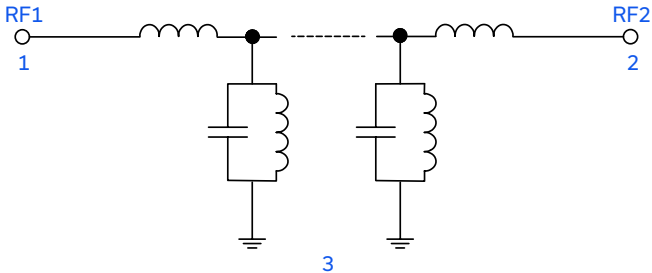

Figure 1. BFHKI-2492+ Functional Diagram

### PAD DESCRIPTION

Function	Pad Number	Description
RF1 <sup>2</sup>	1	Connects to RF Input Port
RF2 <sup>2</sup>	2	Connects to RF Output Port
GROUND	3	Connects to Ground on PCB, (See drawing PL-767)

### SUGGESTED PCB LAYOUT (PL-767)

#### STACK-UP DIAGRAM

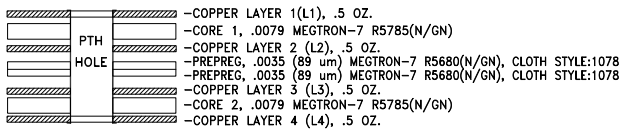

- TOTAL FINISHED THICKNESS 0.026 ± 10%.
- PTH PRESENT FROM COPPER LAYER 1 TO COPPER LAYER 4.

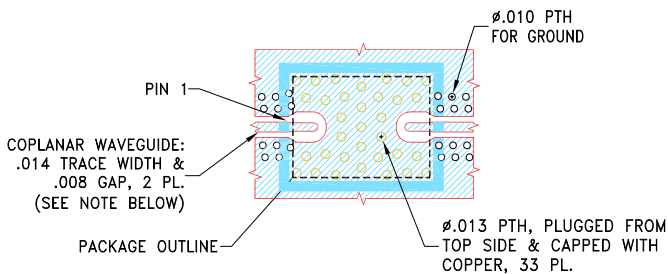

- NOTES:
- PCB IS MULTILAYER PCB, SEE STACK-UP DIAGRAM.
  - TRACE WIDTH & GAP ARE SHOWN FOR .0079 MEGTRON-7 R5785(N/GN), COPPER: 1/2 OZ. EACH LAYER. FOR OTHER MATERIALS TRACE WIDTH & GAP MAY NEED TO BE MODIFIED.
  - LAYERS L2, L3 & L4 OF PCB ARE CONTINUOUS GROUND PLANES.

- DENOTES PCB COPPER LAYOUT WITH SMOBC (SOLDER MASK OVER BARE COPPER).
- DENOTES COPPER LAND PATTERN FREE OF SOLDER MASK.

Figure 2. Suggested PCB Layout for BFHKI-2492+

### CASE STYLE DRAWING

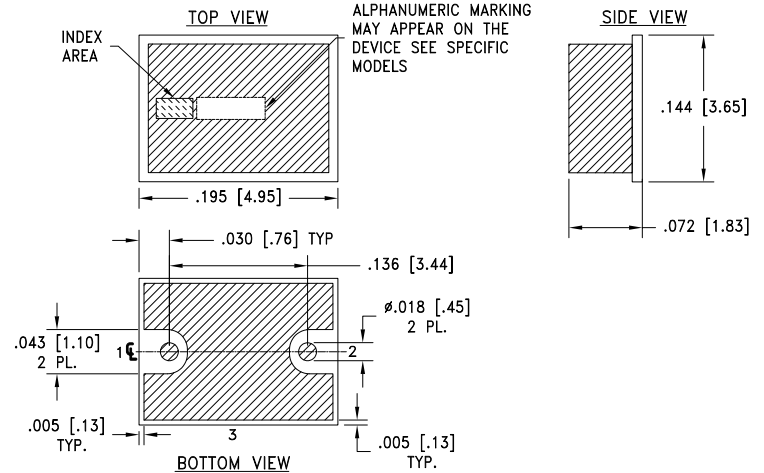

Weight: .135 grams.  
Dimensions are in inches [mm]. Tolerances: 2 Pl. ±.01; 3 Pl. ±.005

### PRODUCT MARKING\*: F472

\*Marking may contain other features or characters for internal lot control.



LTCC SURFACE MOUNT

# Bandpass Filter

## BFHKI-2492+

50Ω 22 to 28 GHz

ADDITIONAL DETAILED INFORMATION IS AVAILABLE ON OUR DASH BOARD.

[CLICK HERE](#)

Performance Data & Graphs	Data Graphs S-Parameter (S2P Files) Data Set (.zip file) De-embedded to device pads
Case Style	NM3237 Finish: Gold over Nickel Plating
RoHS Status	Compliant
Tape and Reel	F77
Suggested Layout for PCB Design	PL-767
Evaluation Board	TB-BFHKI-2492C+ Gerber File
Environmental Rating	ENV06T12

### NOTES

- A. Performance and quality attributes and conditions not expressly stated in this specification document are intended to be excluded and do not form a part of this specification document.
- B. Electrical specifications and performance data contained in this specification document are based on Mini-Circuits' applicable established test performance criteria and measurement instructions.
- C. The parts covered by this specification document are subject to Mini-Circuits' standard limited warranty and terms and conditions (collectively, "Standard Terms"); Purchasers of this part are entitled to the rights and benefits contained therein. For a full statement of the standard terms and the exclusive rights and remedies thereunder, please visit Mini-Circuits' website at [www.minicircuits.com/terms/viewterm.html](http://www.minicircuits.com/terms/viewterm.html)



# LTCC Lowpass Filter

Typical Performance Data

# BFHKL-2492+

FREQUENCY (GHz)	INSERTION LOSS (dB)			RETURN LOSS (dB)		
	@-55°C	@+25°C	@+125°C	@-55°C	@+25°C	@+125°C
0.1	112.39	105.00	103.52	0.04	0.06	0.08
1.0	85.54	85.84	85.44	0.12	0.13	0.14
2.0	79.86	79.64	79.75	0.06	0.05	0.06
3.0	77.55	77.25	77.30	0.07	0.05	0.04
4.0	77.48	77.66	77.37	0.04	0.11	0.13
5.0	82.53	82.26	82.28	0.09	0.16	0.16
6.0	81.78	82.07	82.62	0.05	0.10	0.11
7.0	78.01	77.17	75.98	0.02	0.09	0.13
8.0	69.12	69.50	70.19	0.07	0.15	0.18
9.0	78.41	77.70	76.86	0.13	0.22	0.24
10.0	72.42	71.92	71.18	0.17	0.28	0.28
11.0	66.81	66.65	66.04	0.15	0.26	0.29
12.0	64.47	64.36	63.48	0.16	0.27	0.33
13.0	57.33	57.06	56.99	0.15	0.30	0.37
14.0	57.27	57.46	57.57	0.14	0.26	0.31
15.0	53.55	53.67	53.66	0.17	0.29	0.32
16.0	52.31	52.34	52.61	0.21	0.37	0.39
17.0	53.17	53.61	53.76	0.11	0.27	0.30
18.0	56.15	56.48	56.40	0.07	0.21	0.31
19.0	55.20	54.07	52.27	0.23	0.40	0.41
20.0	39.17	36.66	32.93	0.36	0.57	0.70
21.0	11.90	8.31	4.96	1.57	3.41	7.92
22.0	1.53	1.81	2.00	22.87	29.26	32.64
22.5	1.44	1.87	2.20	17.12	13.91	11.61
23.0	1.71	1.99	2.13	9.94	10.58	11.28
23.5	1.42	1.63	1.82	14.42	19.14	21.60
24.0	1.37	1.82	2.22	15.20	12.31	10.10
24.5	1.84	2.13	2.18	9.04	9.09	10.61
25.0	1.49	1.67	1.80	12.25	15.50	21.12
25.5	1.31	1.79	2.21	17.63	13.12	10.57
26.0	1.78	2.19	2.36	9.38	9.29	9.65
26.5	1.68	1.87	2.04	10.82	14.53	18.60
27.0	1.47	2.00	2.59	19.06	13.46	9.42
27.5	2.21	2.65	2.81	8.09	7.96	8.97
28.0	2.08	2.25	2.49	9.98	13.44	19.72
29.0	2.81	3.31	3.80	8.08	9.39	13.30
30.0	9.60	17.17	25.82	4.78	2.49	1.48
31.0	40.17	44.34	49.19	0.48	0.66	0.70
32.0	55.69	58.27	60.79	0.32	0.49	0.59
33.0	72.28	76.79	75.92	0.23	0.52	0.53
34.0	77.05	73.09	69.60	0.47	0.62	0.65
35.0	59.54	58.71	57.84	0.27	0.48	0.70
36.0	56.51	56.17	55.13	0.10	0.46	0.55
37.0	57.21	56.45	55.25	0.56	0.75	0.80
38.0	58.68	59.20	58.89	0.38	0.69	0.69
39.0	57.95	57.69	56.33	0.00	0.53	0.71
40.0	55.13	54.97	56.74	0.33	0.70	0.75
41.0	59.35	59.31	58.02	0.19	0.51	0.57
42.0	55.90	55.44	54.95	0.23	0.58	0.66
43.0	54.77	55.76	56.30	0.22	0.59	0.57
44.0	56.85	56.62	55.51	0.02	0.40	0.51
45.0	55.95	57.05	61.68	0.11	0.40	0.47
46.0	61.49	64.35	62.82	0.14	0.50	0.47
47.0	60.14	60.09	59.55	0.14	0.51	0.55
48.0	56.19	56.71	56.84	0.07	0.37	0.45
49.0	52.98	52.12	51.78	0.15	0.56	0.68
50.0	50.74	51.67	52.16	0.29	0.67	0.78
51.0	53.22	54.09	54.05	0.17	0.50	0.67
52.0	57.78	58.70	59.37	0.01	0.51	0.66
53.0	65.74	66.60	71.19	0.43	0.78	0.90
54.0	65.60	54.75	64.56	0.39	0.80	0.84
55.0	61.10	61.15	60.15	0.23	0.69	0.94
56.0	61.38	63.16	65.39	0.45	0.90	1.00
57.0	69.61	66.65	63.62	0.10	0.70	0.65
58.0	60.68	62.09	66.54	0.34	0.85	1.12
59.0	66.07	64.30	64.78	0.06	0.91	0.79
60.0	58.65	63.09	76.00	0.08	0.55	0.68
61.0	61.78	65.78	68.79	0.03	0.56	0.88
62.0	61.86	63.76	70.58	0.17	0.94	0.53
63.0	63.06	67.65	71.35	0.05	0.64	0.71
64.0	68.12	67.12	66.90	0.09	0.50	0.65
65.0	64.16	63.41	60.96	0.80	1.37	1.26



P.O. Box 350166, Brooklyn, New York 11235-0003 (718) 934-4500 • Fax (718) 332-4661 For detailed performance specs & shopping online see Mini-Circuits web site  
 The Design Engineers Search Engine Provides ACTUAL Data Instantly From MINI-CIRCUITS At: www.minicircuits.com

IF/RF MICROWAVE COMPONENTS

## Typical Performance Data

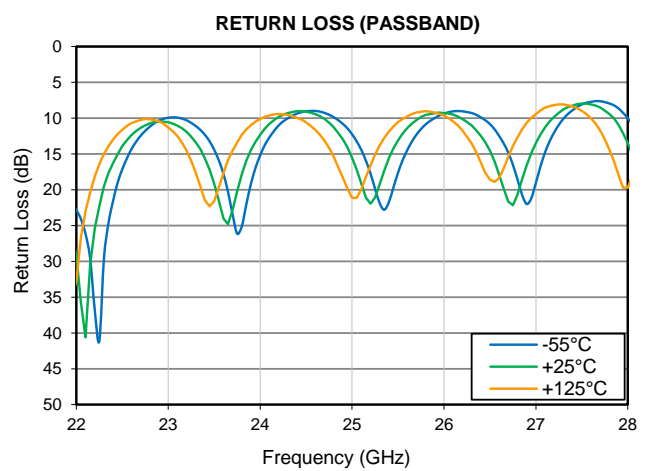
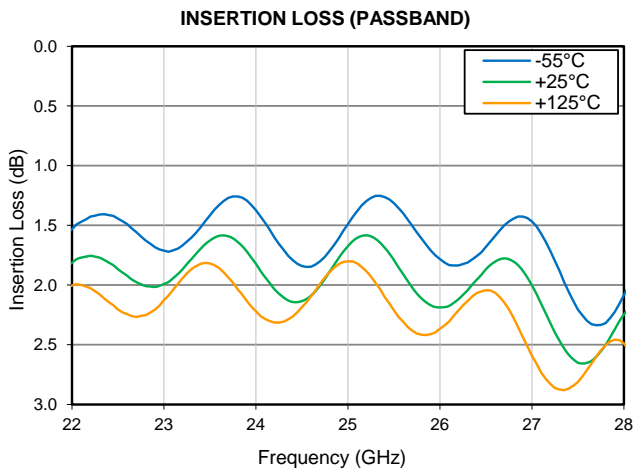
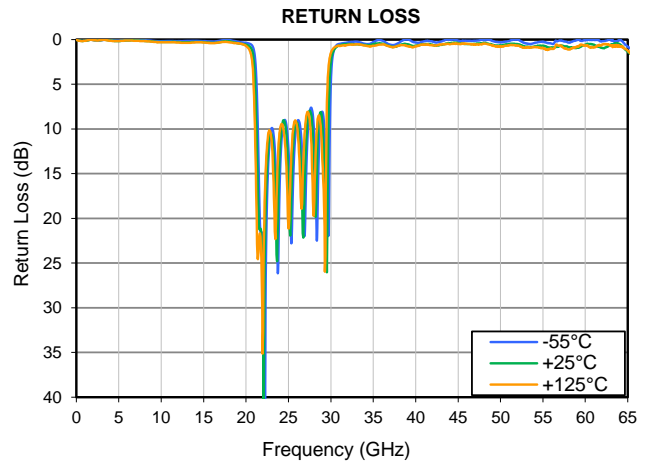
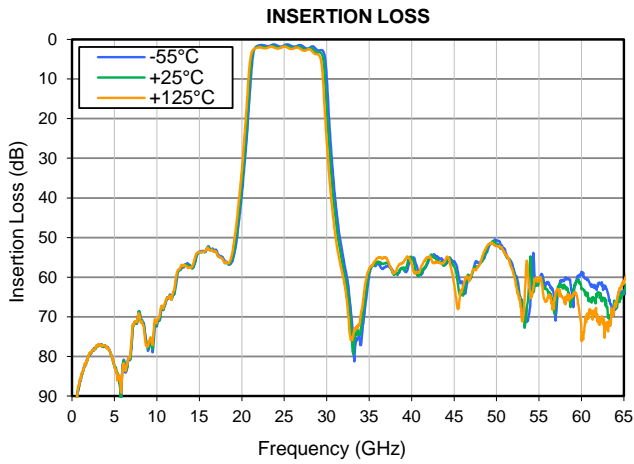

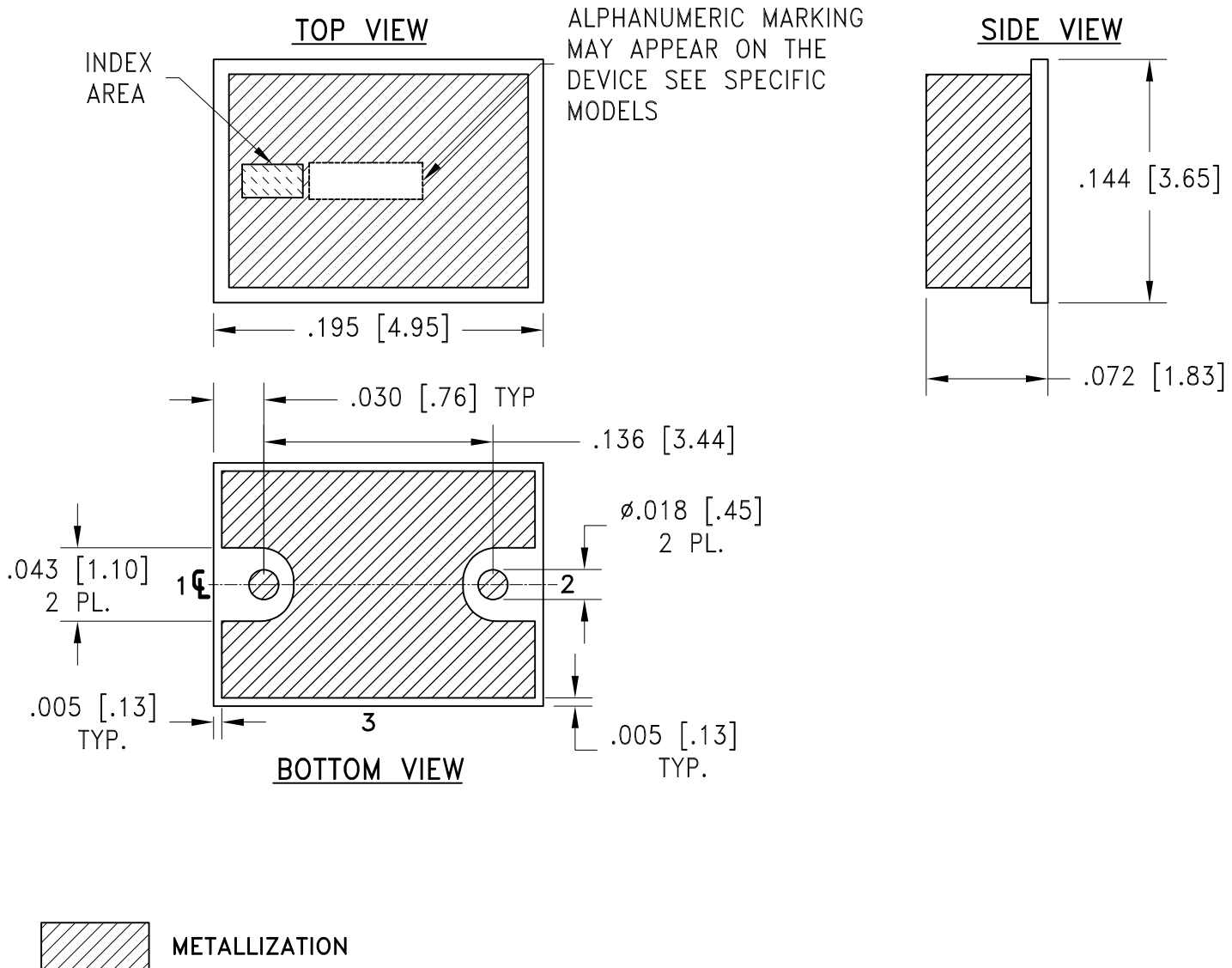

Weight: .135 grams.

Dimensions are in inches (mm). Tolerances: 2 Pl.  $\pm$ .01; 3 Pl.  $\pm$ .005

### Notes:

1. Case material: LTCC on printed circuit board base.
2. Termination Finish: **as shown below or indicated on Data Sheet.**  
For RoHS Case Styles: Gold Plate over Nickel plate. All models, (+) suffix.

**Mini-Circuits**<sup>®</sup>

INTERNET <http://www.minicircuits.com>

P.O. Box 350166, Brooklyn, New York 11235-0003 (718) 934-4500 Fax (718) 332-4661

Distribution Centers NORTH AMERICA 800-654-7949 • 417-335-5935 • Fax 417-335-5945 • EUROPE 44-1252-832600 • Fax 44-1252-837010

Mini-Circuits ISO 9001 & ISO 14001 Certified



THIRD ANGLE PROJECTION

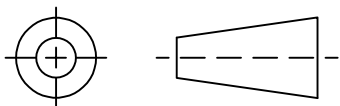

REVISIONS

REV	ECN No.	DESCRIPTION	DATE	DR	AUTH
OR	ECO-019771	NEW RELEASE	11/06/23	ITG	IL

SUGGESTED MOUNTING CONFIGURATION  
FOR NM3237 CASE STYLE

STACK-UP DIAGRAM

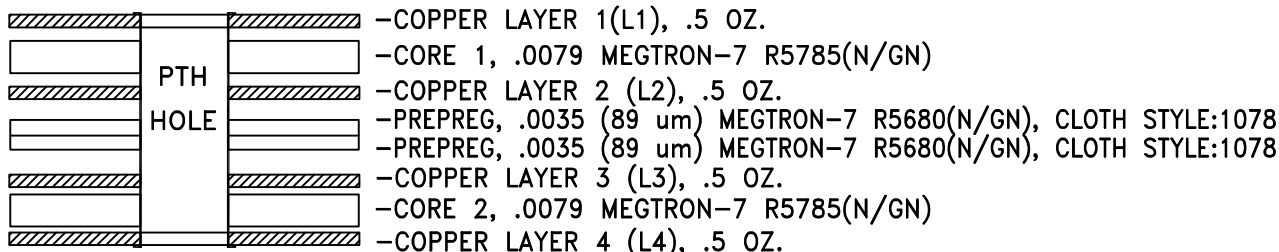

- TOTAL FINISHED THICKNESS 0.026 ± 10%.
- PTH PRESENT FROM COPPER LAYER 1 TO COPPER LAYER 4.

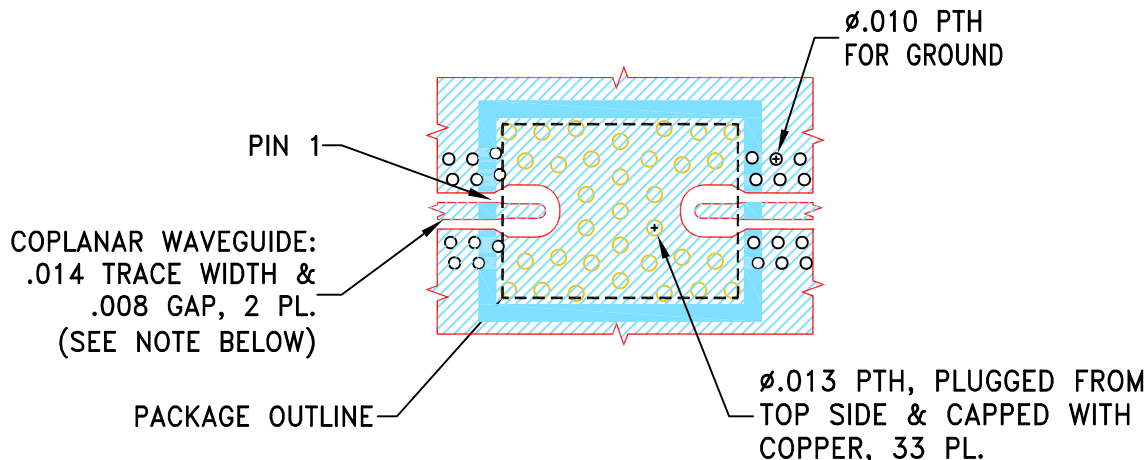

NOTES:

- PCB IS MULTILAYER PCB, SEE STACK-UP DIAGRAM.
- TRACE WIDTH & GAP ARE SHOWN FOR .0079 MEGTRON-7 R5785(N/GN), COPPER: 1/2 OZ. EACH LAYER. FOR OTHER MATERIALS TRACE WIDTH & GAP MAY NEED TO BE MODIFIED.
- LAYERS L2, L3 & L4 OF PCB ARE CONTINUOUS GROUND PLANES.



DENOTES PCB COPPER LAYOUT WITH SMOBC (SOLDER MASK OVER BARE COPPER).

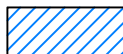

DENOTES COPPER LAND PATTERN FREE OF SOLDER MASK.

UNLESS OTHERWISE SPECIFIED	INITIALS	DATE
DIMENSIONS ARE IN INCHES	DRAWN ITG	11/06/23
TOLERANCES ON:	CHECKED GF	11/06/23
2 PL DECIMALS ±	APPROVED IL	11/06/23
3 PL DECIMALS ± .005		
ANGLES ±		
FRACTIONS ±		



Mini-Circuits®

13 Neptune Avenue  
Brooklyn NY 11235

PL,NM3237, TB-BFHKI-XXXXC+

Mini-Circuits®  
THIS DOCUMENT AND ITS CONTENTS ARE THE PROPERTY OF MINI-CIRCUITS. EXCEPT FOR USE EXPRESSLY GRANTED, IN WRITING, TO ITS VENDORS, VENDEE AND THE UNITED STATES GOVERNMENT, MINI-CIRCUITS RESERVES ALL PROPRIETARY DESIGN, USE, MANUFACTURING AND REPRODUCTION RIGHTS THERETO. THESE CONTENTS SHALL NOT BE USED, DUPLICATED OR DISCLOSED TO ANY OUTSIDE PARTY, IN WHOLE OR IN PART, WITHOUT WRITTEN PERMISSION OF MINI-CIRCUITS.

SIZE	CODE IDENT	DRAWING NO:	REV:
A	15542	98-PL-767	OR
FILE:	98PL767	SCALE: 6:1	SHEET: 1 OF 1

# Evaluation Board and Circuit

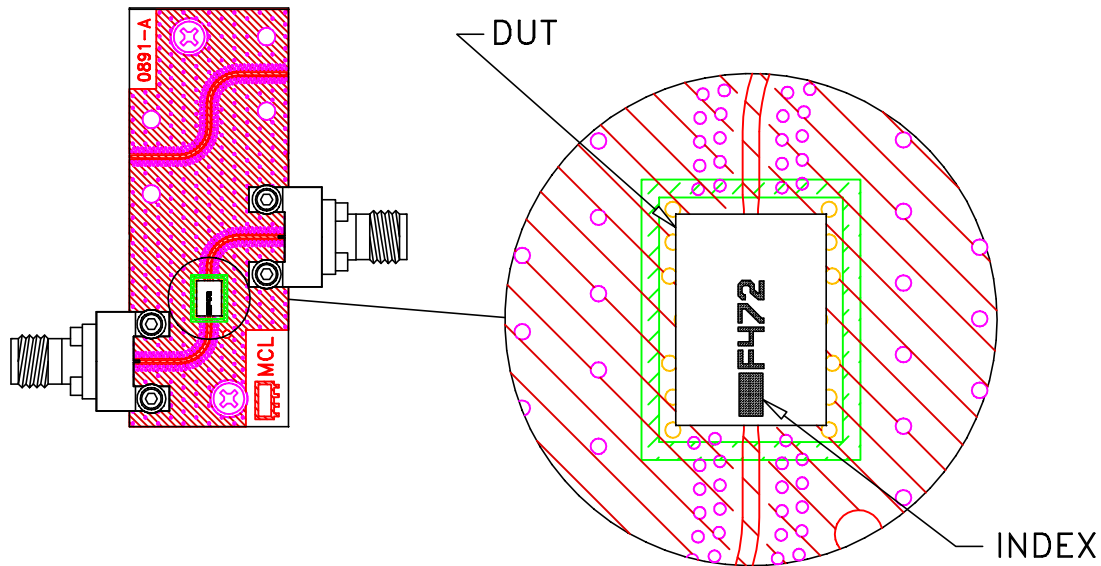

TB-BFHKI-2492C+

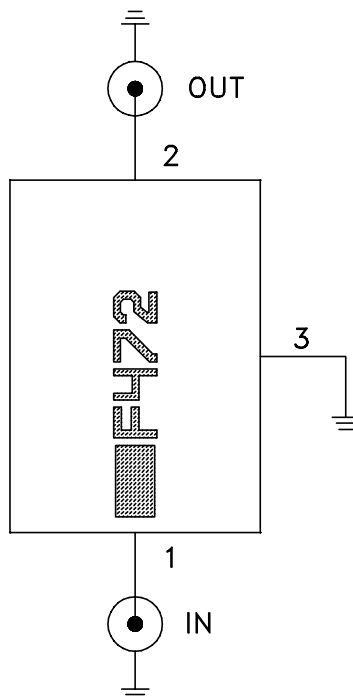

Schematic Diagram

1. 50 Ohm 1.85 mm Female end Launch connectors.
2. PCB Material: MEGTRON-7 R5785(N or GN) or equivalent, Dielectric Constant=3.37 Thickness=.0079 inch.

 **Mini-Circuits®**

All Mini-Circuits products are manufactured under exacting quality assurance and control standards, and are capable of meeting published specifications after being subjected to any or all of the following physical and environmental test.

<b>Specification</b>	<b>Test/Inspection Condition</b>	<b>Reference/Spec</b>
Operating Temperature	-55° to 125° C Ambient Environment	Individual Model Data Sheet
Storage Temperature	-55° to 125° C Ambient Environment	Individual Model Data Sheet
Thermal Cycling	-55 to 125°C, 100 cycles, Dwell Time 15 minutes.	MIL-STD-202, Method 107, Condition A-3
Humidity	85°C, 90-95% Relative Humidity, 250hours	
Solderability	10X / 30X Magnification	J-STD-002C Test S, J-STD-002C Test S1
High Temp Storage	125°C, 250 hours	
Bend Test	1mm, deflection for 5 seconds Span of bending: 2.75"	--