



LTCC SURFACE MOUNT

Bandpass Filter

BFHKL-1742+

50Ω 16 to 19 GHz

THE BIG DEAL

- LTCC Band Pass Filter with Integrated Interposer Board
- Wide Stopband Rejection, Typ. 66 dB up to 40 GHz
- Small Size, 4.95 mm x 3.65 mm
- Shielded Construction
- Protected by US Patents 11,638,370 and 11,744,057



Generic photo used for illustration purposes only

APPLICATIONS

- Test & Measurement Equipment
- Aerospace and Defense Signal Conditioning
- Satellite Communication

FUNCTIONAL DIAGRAM

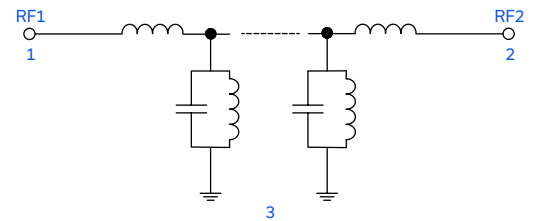

PRODUCT OVERVIEW

BFHKL-1742+ is a miniature low temperature co-fired ceramic (LTCC) ultra-high stopband rejection band pass filter with a 16 to 19 GHz passband that supports a variety of applications. This model achieves 66 dB typical stopband rejection up to 40 GHz, when mounted on coplanar waveguide layouts. Housed in a small 4.95 mm by 3.65 mm ceramic form factor, the filter is ideal for dense signal chain PCB layouts where it complements MMIC size and performance. The BFHKL family with integrated interposer board enables installation onto PCB layouts with automated manufacturing equipment. This model provides 3 dB typical insertion loss over a wide band due to its rugged monolithic construction. The LTCC fabrication process assures minimal RF performance variation while delivering a product that is well suited for environmental extremes of high humidity and temperature.

KEY FEATURES

Features	Advantages
Surface Mountable due to Integrated Interposer Board	Enables installation with automated manufacturing equipment, making this suitable for high-volume processes.
Wide Rejection	Provides high stopband rejection of 66 dB typical up to 40 GHz.
Small Size (4.95 x 3.65 mm)	Saves space in dense circuit board layouts and minimizes the effects of parasitics.
LTCC Construction	Provides repeatable performance in a rugged, ceramic package well suited for tough environments such as high humidity and temperature extremes.
Cost Effective	LTCC is a scalable technology that is cost effective due to its ease of production in high-volume.

REV. OR
ECO-023769
BFHKL-1742+
MCL NY
241127





ELECTRICAL SPECIFICATIONS^{1,2,3} AT +25°C

Parameter		F#	Frequency (GHz)	Min.	Typ.	Max.	Units
Passband	Center Frequency ⁴	—	—	—	17.4	—	GHz
	Insertion Loss	F1-F2	16 - 19	—	3	4	dB
	Return Loss	F1-F2	16 - 19	—	10.5	—	dB
Stopband, Lower	Rejection	DC-F3	0.1 - 10	60	70	—	dB
		F3-F4	10 - 12.9	40	—	—	
Stopband, Upper	Rejection	F5-F6	23.2 - 30.5	37	47	—	dB
		F6-F7	30.5 - 34.4	46	56	—	
		F7-F8	34.4 - 40	56	66	—	

1. Tested on Evaluation Board P/N TB-BFHKI-1742C+. Measured with the connector and feedline effects de-embedded using the 2XThru IEEE P370 method.

2. Bi-directional, RF1 and RF2 ports can be interchanged.

3. This component should not be used as a DC-block. In applications where DC voltage and/or current is present at either the input or output ports, external DC blocking capacitors are required.

4. Typical variation ±3%.

ABSOLUTE MAXIMUM RATINGS⁵

Parameter	Ratings
Operating Temperature	-55°C to +125°C
Storage Temperature	-55°C to +125°C
Input Power ⁶	1 W

5. Permanent damage may occur if any of these limits are exceeded.

6. Power rating applies only to signals within the passband. Power rating above +25°C operating temperature decreases linearly to 0.5 W at +125°C.

TYPICAL FREQUENCY RESPONSE AT +25°C

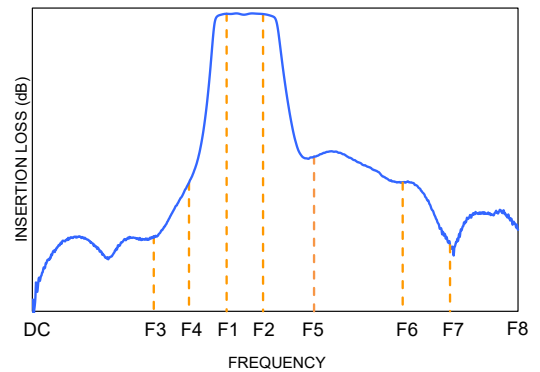



LTCC SURFACE MOUNT

Bandpass Filter

BFHKI-1742+

Mini-Circuits

50Ω 16 to 19 GHz

TYPICAL PERFORMANCE GRAPHS

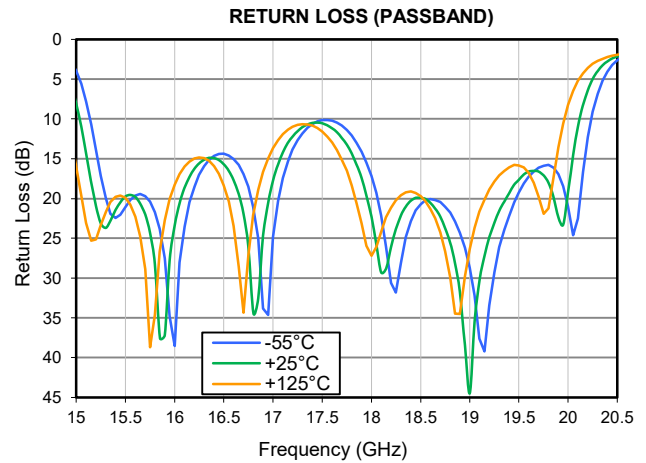
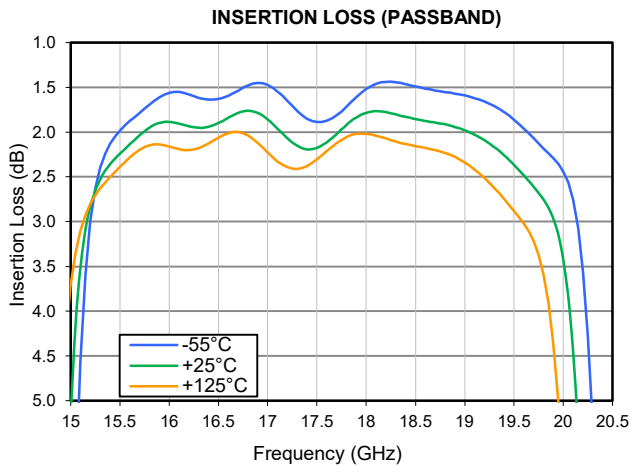
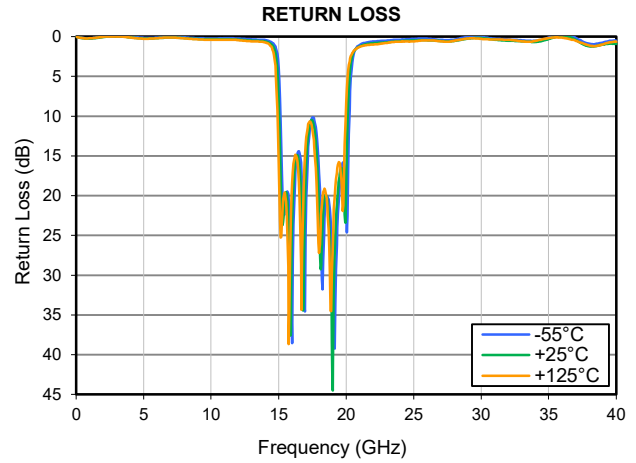
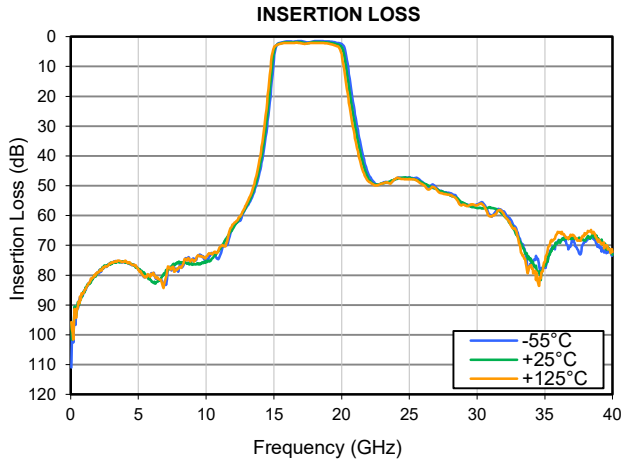



FUNCTIONAL DIAGRAM

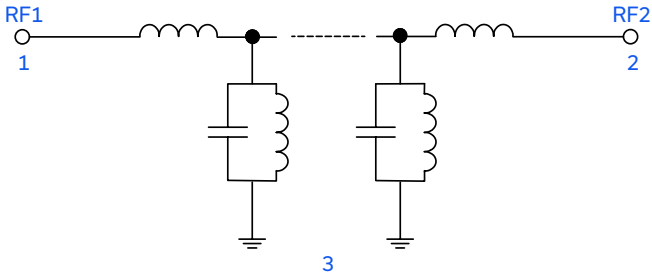
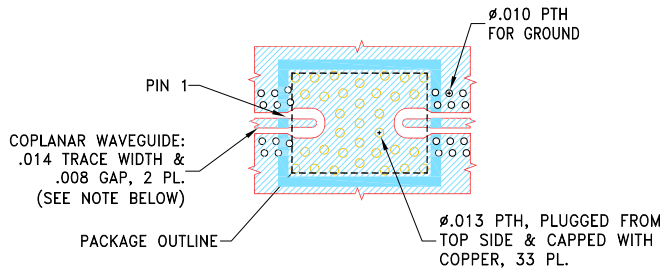

Figure 1. BFHKI-1742+ Functional Diagram

PAD DESCRIPTION

Function	Pad Number	Description
RF1 ²	1	Connects to RF Input Port
RF2 ²	2	Connects to RF Output Port
GROUND	3	Connects to Ground on PCB, (See drawing PL-767)

SUGGESTED PCB LAYOUT (PL-767)



NOTES:

1. PCB IS MULTILAYER PCB, SEE STACK-UP DIAGRAM.
2. TRACE WIDTH & GAP ARE SHOWN FOR .0079 MEGTRON-7 R5785(N/GN), COPPER: 1/2 OZ. EACH LAYER. FOR OTHER MATERIALS TRACE WIDTH & GAP MAY NEED TO BE MODIFIED.
3. LAYERS L2, L3 & L4 OF PCB ARE CONTINUOUS GROUND PLANES.

DENOTES PCB COPPER LAYOUT WITH SMOBC (SOLDER MASK OVER BARE COPPER).

DENOTES COPPER LAND PATTERN FREE OF SOLDER MASK.

STACK-UP DIAGRAM

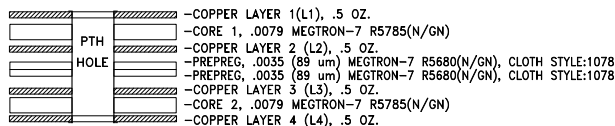

1. TOTAL FINISHED THICKNESS 0.026 ± 10%.
2. PTH PRESENT FROM COPPER LAYER 1 TO COPPER LAYER 4.

Figure 2. Suggested PCB Layout for BFHKI-1742+

CASE STYLE DRAWING (NM3237)

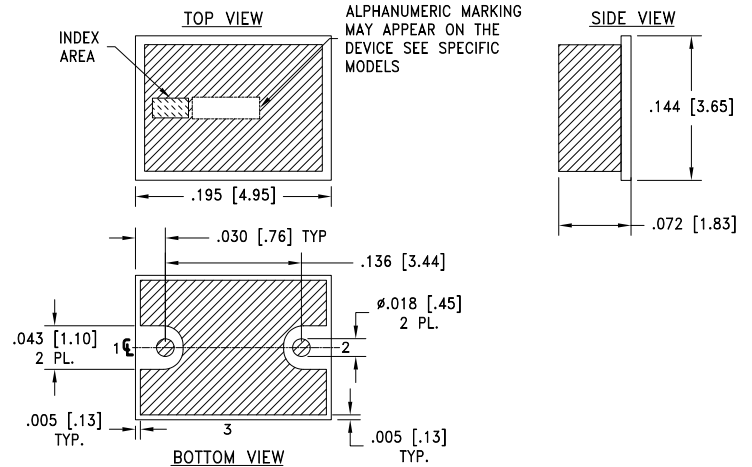

METALLIZATION

Weight: .135 grams.

Dimensions are in inches [mm]. Tolerances: 2 Pl. ±.01; 3 Pl. ±.005

PRODUCT MARKING*: F559

*Marking may contain other features or characters for internal lot control.



LTCC SURFACE MOUNT

Bandpass Filter

BFHKI-1742+

50Ω 16 to 19 GHz

ADDITIONAL DETAILED INFORMATION IS AVAILABLE ON OUR DASHBOARD. [CLICK HERE](#)

Performance Data & Graphs	Data Graphs S-Parameter (S2P Files) Data Set (.zip file) De-embedded to device pads
Case Style	NM3237 Finish: Gold over Nickel Plating
RoHS Status	Compliant
Tape and Reel	TR-F77
Suggested Layout for PCB Design	PL-767
Evaluation Board	TB-BFHKI-1742C+ Gerber File
Environmental Rating	ENV06T12

NOTES

- A. Performance and quality attributes and conditions not expressly stated in this specification document are intended to be excluded and do not form a part of this specification document.
- B. Electrical specifications and performance data contained in this specification document are based on Mini-Circuits' applicable established test performance criteria and measurement instructions.
- C. The parts covered by this specification document are subject to Mini-Circuits' standard limited warranty and terms and conditions (collectively, "Standard Terms"); Purchasers of this part are entitled to the rights and benefits contained therein. For a full statement of the standard terms and the exclusive rights and remedies thereunder, please visit Mini-Circuits' website at www.minicircuits.com/terms/viewterm.html



LTCC Bandpass Filter

Typical Performance Data

BFHKI-1742+

FREQUENCY (GHz)	INSERTION LOSS (dB)			RETURN LOSS (dB)		
	@-55°C	@+25°C	@+125°C	@-55°C	@+25°C	@+125°C
0.1	100.09	101.57	98.19	0.04	0.06	0.06
0.5	90.69	89.95	91.46	0.16	0.18	0.18
1.0	85.23	85.83	85.35	0.19	0.22	0.20
3.0	76.00	76.32	75.91	-0.15	-0.07	-0.03
4.0	75.60	75.66	75.24	-0.03	0.07	0.11
5.0	77.95	77.71	78.24	0.14	0.22	0.24
6.0	79.33	82.27	79.91	0.12	0.17	0.18
7.0	82.22	79.13	81.30	0.02	0.10	0.11
8.0	77.20	75.46	77.32	0.07	0.17	0.20
9.0	74.64	76.48	74.85	0.19	0.28	0.32
10.0	74.84	75.22	73.90	0.22	0.32	0.38
11.0	73.84	71.37	70.74	0.20	0.31	0.37
12.0	63.72	64.26	62.83	0.23	0.37	0.45
13.0	57.04	56.62	55.86	0.32	0.49	0.58
14.0	44.60	42.65	39.90	0.44	0.61	0.71
15.0	7.93	5.20	3.73	3.94	8.07	15.96
15.5	1.98	2.24	2.39	21.07	19.74	19.92
16.0	1.56	1.88	2.16	38.53	23.39	18.28
16.5	1.63	1.90	2.06	14.38	15.69	18.33
17.0	1.47	1.86	2.23	24.84	17.79	13.68
17.5	1.89	2.18	2.30	10.15	10.56	11.60
18.0	1.52	1.78	2.02	17.19	22.27	27.18
18.5	1.49	1.85	2.16	20.73	19.93	19.71
19.0	1.59	1.98	2.34	28.72	44.50	26.35
19.5	1.86	2.36	2.88	19.27	17.63	15.83
20.0	2.44	3.42	5.90	20.99	19.24	8.25
21.0	26.13	29.97	34.13	1.03	1.23	1.28
22.0	46.17	47.68	48.56	0.60	0.82	0.99
23.0	49.18	49.25	49.27	0.50	0.71	0.79
24.0	47.69	47.74	47.62	0.38	0.56	0.61
25.0	47.19	47.35	47.83	0.28	0.48	0.59
26.0	48.81	49.10	49.51	0.24	0.45	0.47
27.0	50.69	51.08	51.24	0.39	0.54	0.57
28.0	52.50	53.17	53.03	0.36	0.53	0.53
29.0	56.16	55.79	56.28	0.04	0.24	0.21
30.0	56.23	57.49	56.59	0.04	0.16	0.27
31.0	59.79	57.45	60.14	0.24	0.37	0.32
32.0	58.61	60.17	59.81	0.33	0.50	0.39
33.0	65.77	66.93	67.10	0.47	0.58	0.57
34.0	77.02	74.82	76.58	0.53	0.65	0.54
35.0	77.38	76.08	75.54	0.11	0.29	0.18
36.0	68.75	68.98	65.61	-0.30	-0.10	0.13
37.0	68.52	67.49	66.71	0.14	0.40	0.51
38.0	68.77	68.35	66.02	0.90	1.21	1.09
39.0	70.03	68.38	67.98	0.75	1.01	0.99
40.0	72.77	73.15	72.20	0.52	0.91	0.63



P.O. Box 350166, Brooklyn, New York 11235-0003 (718) 934-4500 • Fax (718) 332-4661 For detailed performance specs & shopping online see Mini-Circuits web site

The Design Engineers Search Engine Provides ACTUAL Data Instantly From MINI-CIRCUITS At: www.minicircuits.com

IF/RF MICROWAVE COMPONENTS

REV. OR
BFHKI-1742+
11/26/2024
Page 1 of 1

Typical Performance Data

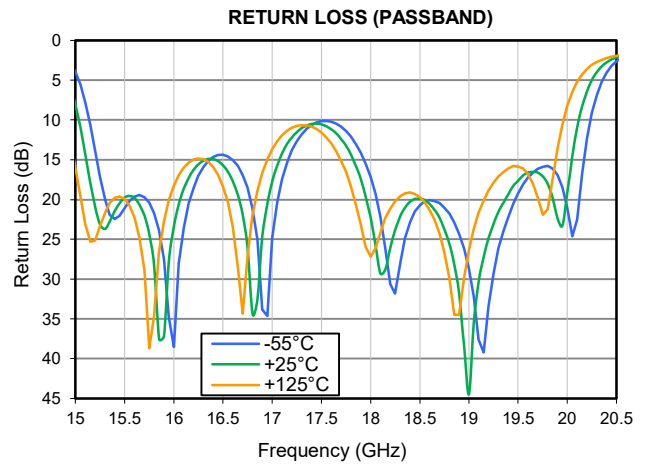
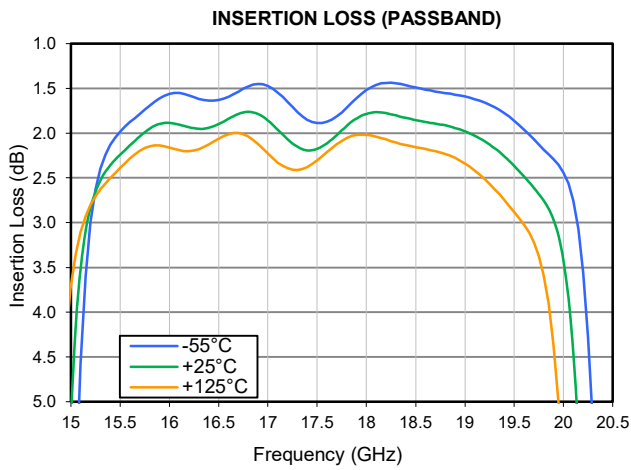
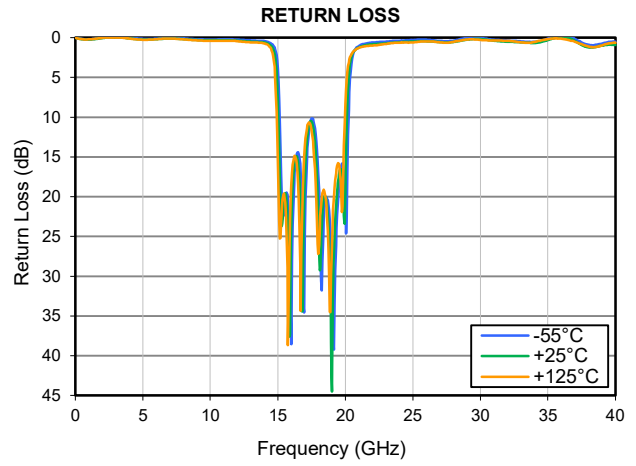
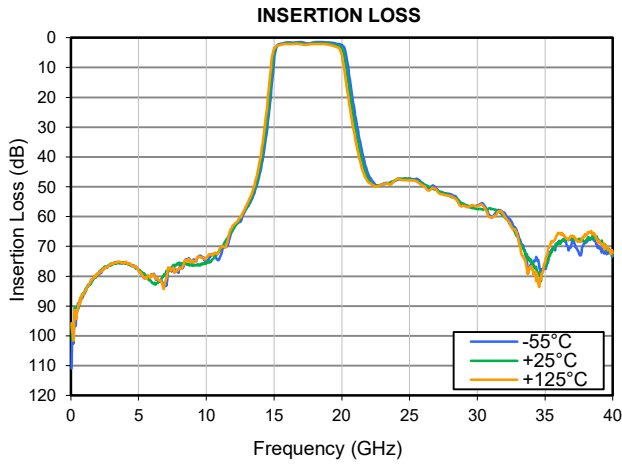

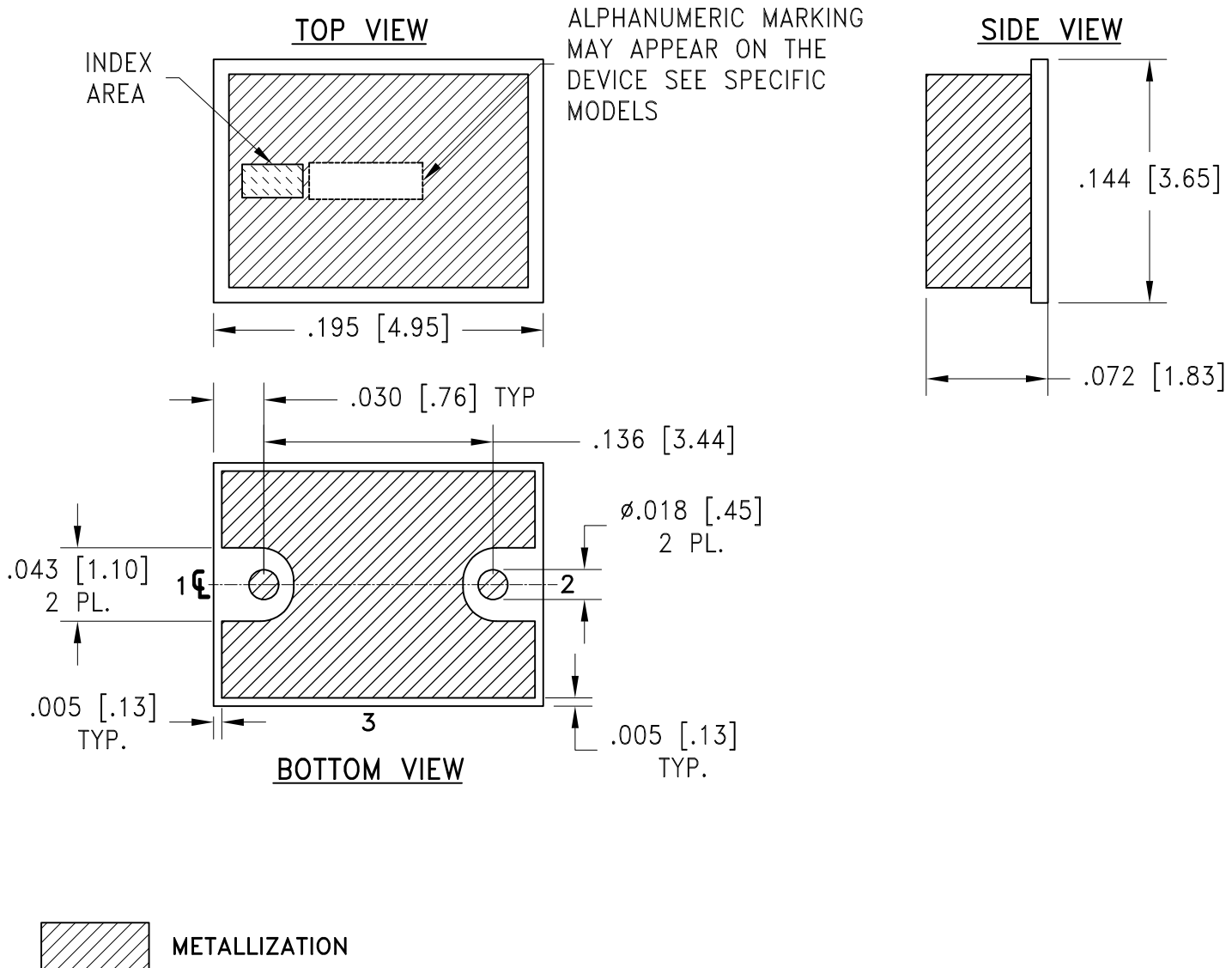

Weight: .135 grams.

Dimensions are in inches (mm). Tolerances: 2 Pl.±.01; 3 Pl. ±.005

Notes:

1. Case material: LTCC on printed circuit board base.
2. Termination Finish: **as shown below or indicated on Data Sheet.**
For RoHS Case Styles: Gold Plate over Nickel plate. All models, (+) suffix.

THIRD ANGLE PROJECTION

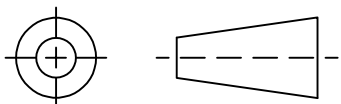

REVISIONS

REV	ECN No.	DESCRIPTION	DATE	DR	AUTH
OR	ECO-019771	NEW RELEASE	11/06/23	ITG	IL

SUGGESTED MOUNTING CONFIGURATION
FOR NM3237 CASE STYLE

STACK-UP DIAGRAM

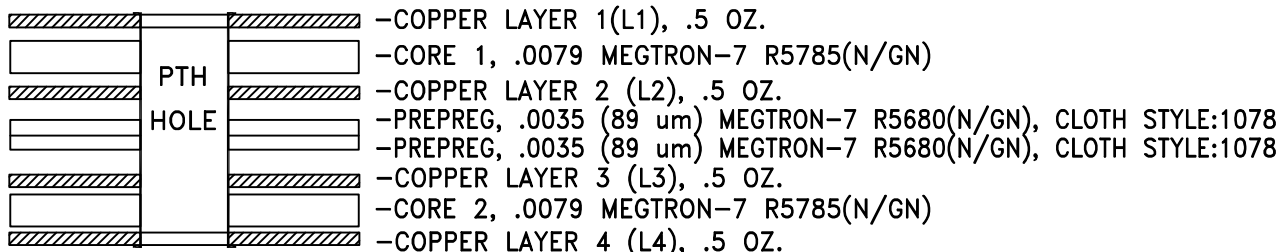

1. TOTAL FINISHED THICKNESS 0.026 ± 10%.
2. PTH PRESENT FROM COPPER LAYER 1 TO COPPER LAYER 4.

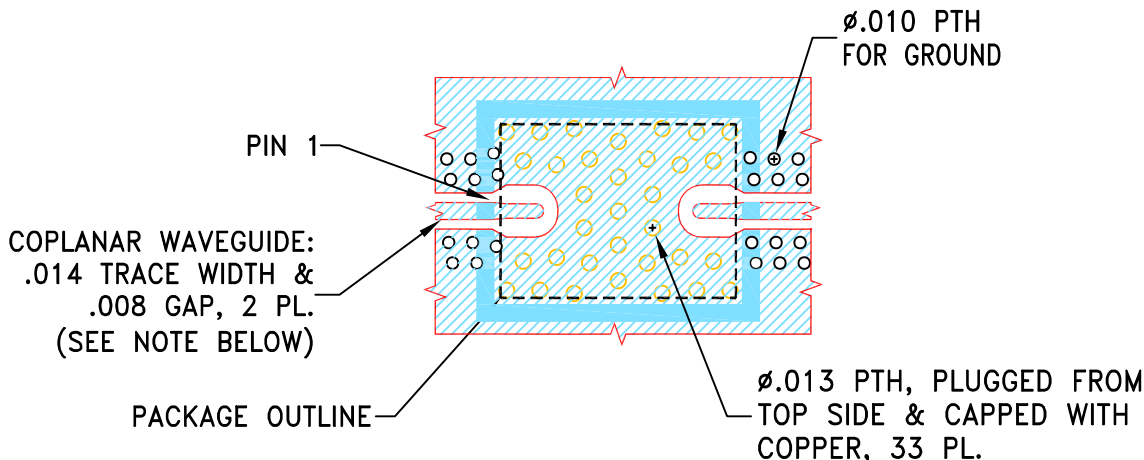

NOTES:

1. PCB IS MULTILAYER PCB, SEE STACK-UP DIAGRAM.
2. TRACE WIDTH & GAP ARE SHOWN FOR .0079 MEGTRON-7 R5785(N/GN), COPPER: 1/2 OZ. EACH LAYER. FOR OTHER MATERIALS TRACE WIDTH & GAP MAY NEED TO BE MODIFIED.
3. LAYERS L2, L3 & L4 OF PCB ARE CONTINUOUS GROUND PLANES.



DENOTES PCB COPPER LAYOUT WITH SMOBC (SOLDER MASK OVER BARE COPPER).



DENOTES COPPER LAND PATTERN FREE OF SOLDER MASK.

UNLESS OTHERWISE SPECIFIED	INITIALS	DATE
DIMENSIONS ARE IN INCHES	ITG	11/06/23
TOLERANCES ON:	GF	11/06/23
2 PL DECIMALS ±	IL	11/06/23
3 PL DECIMALS ± .005		
ANGLES ±		
FRACTIONS ±		



Mini-Circuits®

13 Neptune Avenue
Brooklyn NY 11235

PL,NM3237, TB-BFHKI-XXXXC+

SIZE A	CODE IDENT 15542	DRAWING NO: 98-PL-767	REV: OR
FILE: 98PL767	SCALE: 6:1	SHEET: 1 OF 1	

Evaluation Board and Circuit

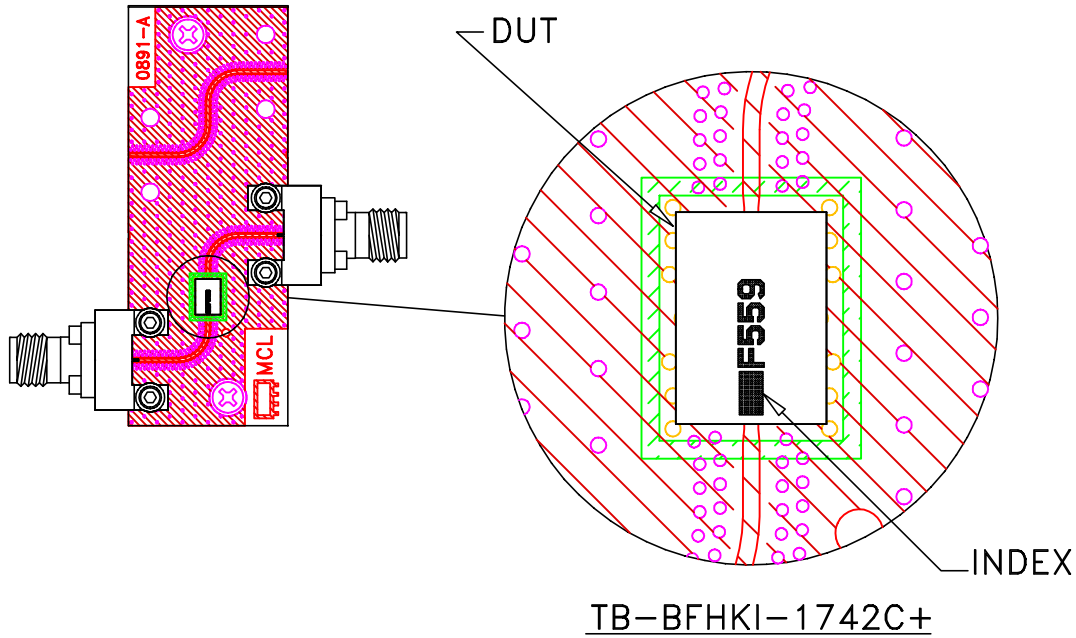

TB-BFHKI-1742C+

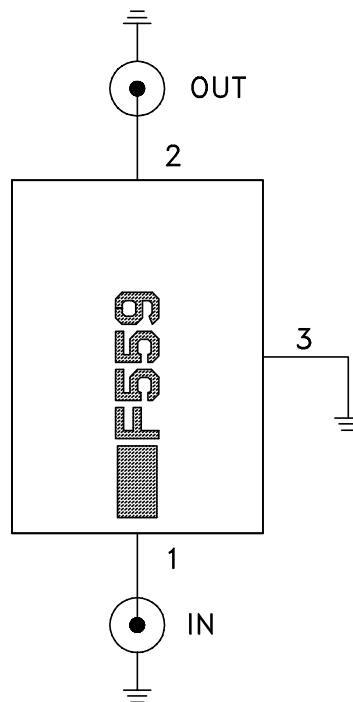

Schematic Diagram

1. 50 Ohm 2.92 mm Female end Launch connectors.
2. PCB Material: MEGTRON-7 R5785(N or GN) or equivalent, Dielectric Constant=3.37 Thickness=.0079 inch.

 **Mini-Circuits®**

All Mini-Circuits products are manufactured under exacting quality assurance and control standards, and are capable of meeting published specifications after being subjected to any or all of the following physical and environmental test.

Specification	Test/Inspection Condition	Reference/Spec
Operating Temperature	-55° to 125° C Ambient Environment	Individual Model Data Sheet
Storage Temperature	-55° to 125° C Ambient Environment	Individual Model Data Sheet
Thermal Cycling	-55 to 125°C, 100 cycles, Dwell Time 15 minutes.	MIL-STD-202, Method 107, Condition A-3
Humidity	85°C, 90-95% Relative Humidity, 250hours	
Solderability	10X / 30X Magnification	J-STD-002C Test S, J-STD-002C Test S1
High Temp Storage	125°C, 250 hours	
Bend Test	1mm, deflection for 5 seconds Span of bending: 2.75"	--