



LTCC SURFACE MOUNT

Bandpass Filter

BFHK-5001+

50Ω 4.5 to 5.3 GHz

THE BIG DEAL

- Ultra-High Stopband Rejection, Typ. 80 dB
- Standard Small 1812 (4.5mm x 3.2mm) Case Style
- Rugged Ceramic Construction
- Protected by US Patents 11,638,370 and 11,744,057



Generic photo used for illustration purposes only

APPLICATIONS

- Satellite Communication
- Aerospace and Defense Signal Conditioning
- Quantum Computing

FUNCTIONAL DIAGRAM

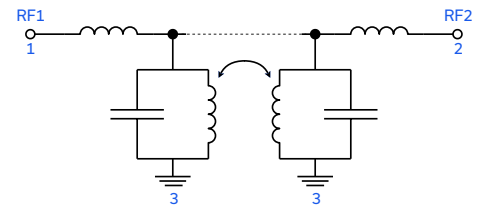

PRODUCT OVERVIEW

The BFHK-5001+ LTCC Bandpass Filter achieves a miniature size and highly repeatable performance by utilizing a proprietary LTCC material system and distributed filter topology. The passband loss between 4.5 – 5.3 GHz is typically 3.6 dB, with typical stopband rejection of 80 dB up to 2.5 GHz and 73 dB up to 12.6 GHz. This model handles up to 1 W RF input power and has a wide operating temperature range from -55°C to +125°C.

KEY FEATURES

Features	Advantages
Ultra-High Rejection	Typical stopband rejections of 80 dB up to 2.5 GHz and 73 dB up to 12.6 GHz.
LTCC Construction	The use of LTCC technology allows for repeatable performance in a rugged ceramic package, well suited for tough environments with high humidity and temperature extremes. See Mini-Circuits Environmental Rating ENV06T12 for more information.
Cost Effective	LTCC is a scalable technology that is cost effective due to its ease of production in high quantities.
Small Size (4.5 mm x 3.2 mm)	Allows for highly dense circuit board layouts, while minimizing the effects of parasitics.
Surface Mountable	Suitable for very high-volume automated assembly process.





ELECTRICAL SPECIFICATIONS^{1,2,3} AT +25°C

Parameter	F#	Frequency (GHz)	Min.	Typ.	Max.	Units
Center Frequency ⁴	—	—	—	4.9	—	GHz
Passband	Insertion Loss	F1-F2	—	3.6	4.5	dB
	Return Loss	F1-F2	—	14.0	—	dB
Stopband, Lower	Insertion Loss	DC-F3	73	80	—	dB
Stopband, Upper	Insertion Loss	F4-F5	60	73	—	dB

1. Tested on Evaluation Board P/N TB-BFHK-5001C+ with the connector and feedline effects de-embedded using the 2XThru IEEE P370 method.
2. Bi-directional, RF1 and RF2 ports can be interchanged.
3. In applications where DC voltage and/or current is present at either the input or output ports, external DC blocking capacitors are required.
4. Typical variation ±3.5%

ABSOLUTE MAXIMUM RATINGS⁵

Parameter	Ratings
Operating Temperature	-55°C to +125°C
Storage Temperature	-55°C to +125°C
Input Power ⁶	1 W

5. Permanent damage may occur if any of these limits are exceeded.
6. Power rating applies only to signals within the passband. Power rating above +25°C operating temperature decreases linearly to 0.5 W at +125°C.

TYPICAL FREQUENCY RESPONSE AT +25°C

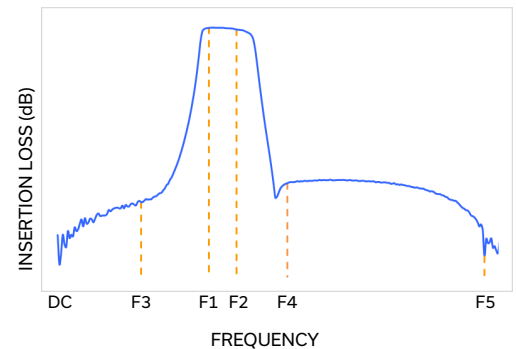



LTCC SURFACE MOUNT

Bandpass Filter

BFHK-5001+

Mini-Circuits

50Ω 4.5 to 5.3 GHz

TYPICAL PERFORMANCE GRAPHS

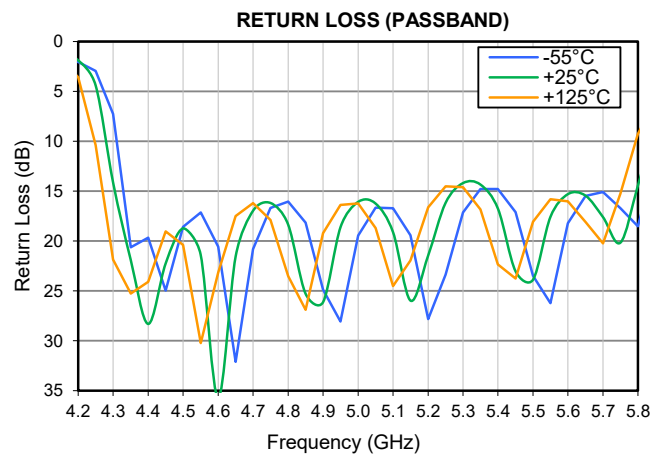
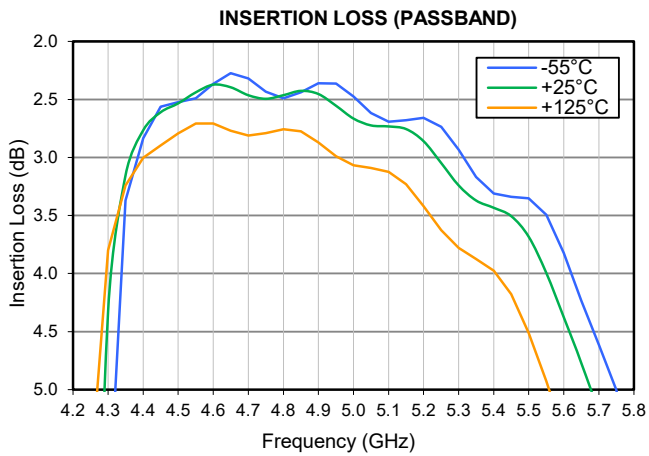
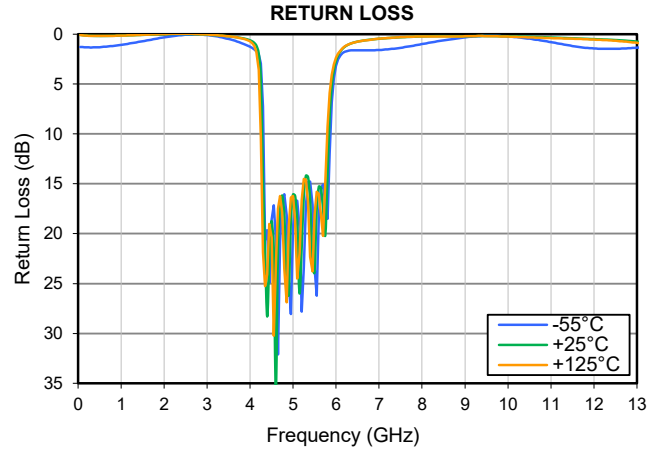
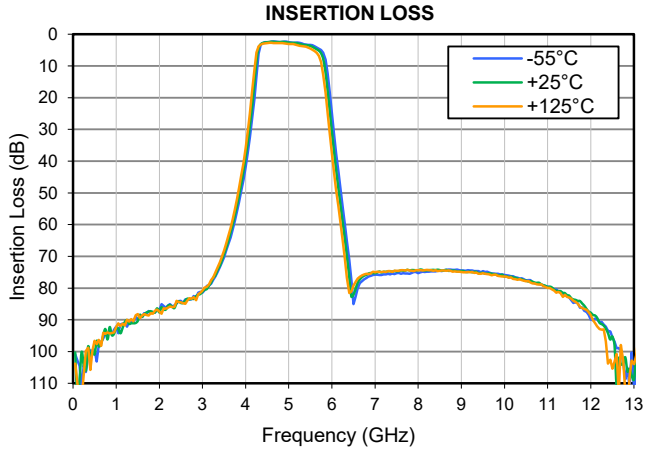



FUNCTIONAL DIAGRAM

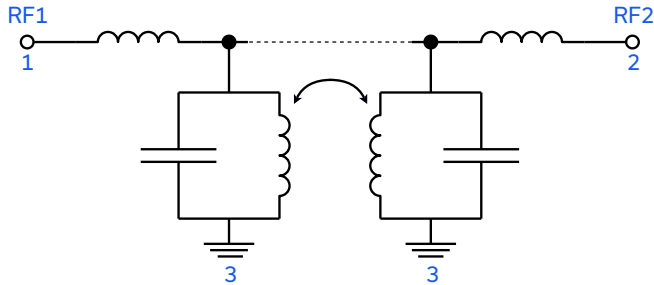
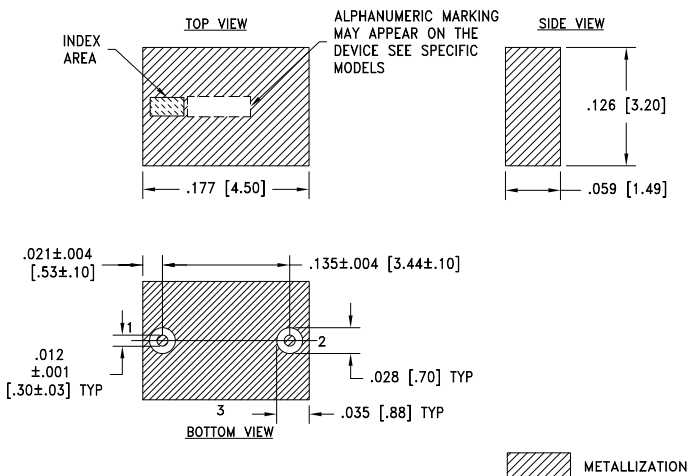

Figure 1. BFHK-5001+ Functional Diagram

PAD DESCRIPTION

Function	Pad Number	Description
RF1 ²	1	Connects to RF Input Port
RF2 ²	2	Connects to RF Output Port
GROUND	3	Connects to Ground on PCB, (See drawing PL-730)

CASE STYLE DRAWING



Weight: .126 grams.
Dimensions are in inches [mm]. Tolerances: 2 Pl. ±.01; 3 Pl. ±.005 Inches

PRODUCT MARKING*: F561

*Marking may contain other features or characters for internal lot control.

SUGGESTED PCB LAYOUT (PL-730)

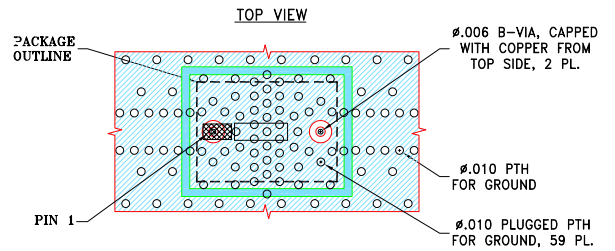

STACK-UP DIAGRAM

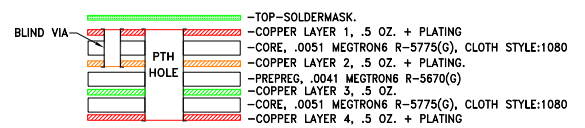

- TOTAL FINISHED THICKNESS 0.0228±.004.
- B-VIA PRESENT FROM COPPER LAYER 1 TO COPPER LAYER 2.
- PTH PRESENT FROM COPPER LAYER 1 TO COPPER LAYER 4.
- INDICATED PLUGGED PTH'S ARE PLUGGED WITH EPOXY AND CAPPED WITH COPPER FROM TOP SIDE.
- LAYER 4 IS CONTINUOUS GROUND PLANE.

NOTES:

- PCB IS MULTILAYER PCB, SEE STACK-UP DIAGRAM.
- TRACE WIDTH & GAP PARAMETERS ARE SHOWN FOR MEGTRON6 R-5775(G), CLOTH STYLE:1080 WITH DIELECTRIC THICKNESS .0051; COPPER: 1/2 OZ.+PLATING. FOR OTHER MATERIALS TRACE WIDTH AND GAP MAY NEED TO BE MODIFIED.
- COPPER LAYER 4 OF THE PCB ARE CONTINUOUS GROUND PLANE.

- DENOTES PCB COPPER LAYOUT WITH SMOBC (SOLDER MASK OVER BARE COPPER)
- DENOTES COPPER LAND PATTERN FREE OF SOLDER MASK

LAYER 2, B-VIA & PTH

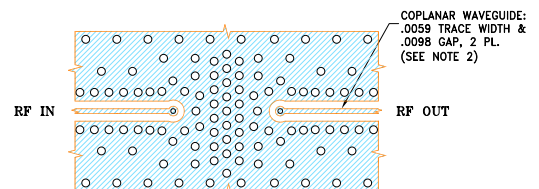

LAYER 3 & PTH

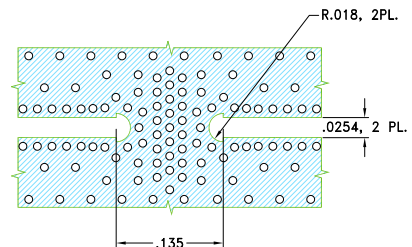

Figure 2. Suggested PCB Layout PL-730



LTCC SURFACE MOUNT

Bandpass Filter

BFHK-5001+

Mini-Circuits

50Ω 4.5 to 5.3 GHz

ADDITIONAL DETAILED INFORMATION IS AVAILABLE ON OUR DASHBOARD. [CLICK HERE](#)

Performance Data & Graphs	Data Graphs S-Parameter (S2P Files) Data Set (.zip file) De-embedded to device pads
Case Style	NM1812C-3 Lead Finish: Tin over Nickel Plating
RoHS Status	Compliant
Tape and Reel	F77
Suggested Layout for PCB Design	PL-730
Evaluation Board	TB-BFHK-5001C+ Gerber File
Environmental Rating	ENV06T12

- NOTES**
- A. Performance and quality attributes and conditions not expressly stated in this specification document are intended to be excluded and do not form a part of this specification document.
 - B. Electrical specifications and performance data contained in this specification document are based on Mini-Circuit's applicable established test performance criteria and measurement instructions.
 - C. The parts covered by this specification document are subject to Mini-Circuits standard limited warranty and terms and conditions (collectively, "Standard Terms"); Purchasers of this part are entitled to the rights and benefits contained therein. For a full statement of the standard terms and the exclusive rights and remedies thereunder, please visit Mini-Circuits' website at www.minicircuits.com/terms/viewterm.html



LTCC Lowpass Filter

Typical Performance Data

BFHK-5001+

FREQUENCY (GHz)	INSERTION LOSS (dB)			RETURN LOSS (dB)		
	@-55°C	@+25°C	@+125°C	@-55°C	@+25°C	@+125°C
0.1	102.89	114.00	110.14	1.28	0.10	0.10
0.2	111.17	100.12	114.64	1.32	0.14	0.15
0.4	99.63	101.73	105.79	1.32	0.17	0.18
0.6	97.90	98.41	96.29	1.26	0.17	0.18
0.8	95.06	96.20	93.99	1.18	0.16	0.17
1.0	92.18	92.54	92.25	1.07	0.14	0.14
1.2	91.00	90.67	91.77	0.93	0.11	0.11
1.4	90.75	91.08	90.44	0.79	0.08	0.08
1.6	89.13	89.06	88.66	0.63	0.05	0.04
1.8	87.71	87.27	87.89	0.47	0.02	0.01
2.0	86.85	87.66	87.43	0.32	0.00	-0.02
2.2	85.49	85.60	86.19	0.19	-0.02	-0.04
2.4	84.86	84.71	84.01	0.10	-0.02	-0.04
2.6	83.57	83.95	84.99	0.04	-0.01	-0.04
2.8	82.50	83.39	82.92	0.03	0.01	-0.01
3.0	81.50	81.14	80.83	0.09	0.05	0.03
3.2	78.62	78.24	77.48	0.20	0.10	0.09
3.4	73.45	73.06	71.88	0.37	0.17	0.16
3.6	66.24	65.10	63.70	0.60	0.26	0.27
3.8	55.94	54.00	52.00	0.89	0.39	0.42
4.0	41.79	38.83	35.83	1.26	0.61	0.72
4.2	20.55	15.97	11.29	2.03	1.88	3.58
4.4	2.83	2.77	3.00	19.65	28.31	24.08
4.5	2.52	2.53	2.79	18.58	18.73	20.37
4.6	2.36	2.37	2.71	20.55	35.72	23.16
4.7	2.32	2.46	2.81	20.81	16.95	16.21
4.8	2.49	2.46	2.76	16.04	18.34	23.52
4.9	2.36	2.45	2.87	24.86	26.12	19.21
5.0	2.48	2.66	3.07	19.45	16.08	16.23
5.1	2.69	2.73	3.12	16.70	19.12	24.50
5.2	2.66	2.86	3.42	27.82	21.49	16.63
5.3	2.93	3.24	3.78	17.14	14.19	14.59
5.4	3.31	3.43	3.98	14.78	16.77	22.33
5.6	3.82	4.38	5.38	18.21	15.29	16.01
5.8	5.79	7.89	12.71	18.52	14.43	9.27
6.0	24.90	30.81	37.56	3.17	2.69	2.37
6.2	49.00	53.95	59.67	1.76	1.27	1.24
6.4	71.15	76.28	81.57	1.63	0.85	0.86
6.6	80.02	78.26	77.00	1.62	0.66	0.67
6.8	76.78	75.84	75.53	1.61	0.54	0.55
7.0	75.77	75.30	74.99	1.58	0.46	0.45
7.2	75.68	74.85	74.84	1.52	0.39	0.38
7.4	75.43	74.84	74.89	1.42	0.34	0.33
7.6	75.46	74.46	74.37	1.29	0.29	0.28
7.8	75.47	74.45	74.42	1.15	0.25	0.25
8.0	75.27	74.40	74.36	0.99	0.23	0.23
8.2	74.83	74.37	74.30	0.84	0.20	0.21
8.4	74.71	74.33	74.37	0.69	0.20	0.22
8.6	74.38	74.44	74.48	0.55	0.20	0.24
8.8	74.27	74.49	74.84	0.43	0.21	0.23
9.0	74.42	74.60	74.93	0.31	0.21	0.20
9.2	74.47	74.78	74.98	0.23	0.19	0.18
9.4	74.61	75.34	75.45	0.18	0.18	0.18
9.6	74.87	75.45	75.55	0.16	0.18	0.20
9.8	75.54	75.65	75.80	0.18	0.19	0.22
10.0	75.85	76.38	76.33	0.22	0.20	0.24
10.2	76.23	76.64	77.15	0.30	0.22	0.27
10.4	76.90	77.17	77.50	0.40	0.24	0.30
10.6	77.52	77.78	78.22	0.52	0.27	0.33
10.8	78.76	78.31	78.92	0.65	0.30	0.36
11.0	79.43	79.73	79.99	0.79	0.33	0.39
11.2	80.44	80.82	81.42	0.95	0.36	0.41
11.4	82.17	81.59	82.13	1.11	0.39	0.44
11.6	84.65	83.58	84.00	1.25	0.42	0.46
11.8	86.05	84.85	86.32	1.36	0.46	0.50
12.0	90.00	87.76	88.56	1.43	0.49	0.54
12.2	90.77	90.90	92.93	1.47	0.53	0.58
12.4	93.44	94.24	103.81	1.48	0.56	0.63
12.6	98.95	110.33	100.72	1.45	0.61	0.70

Typical Performance Data

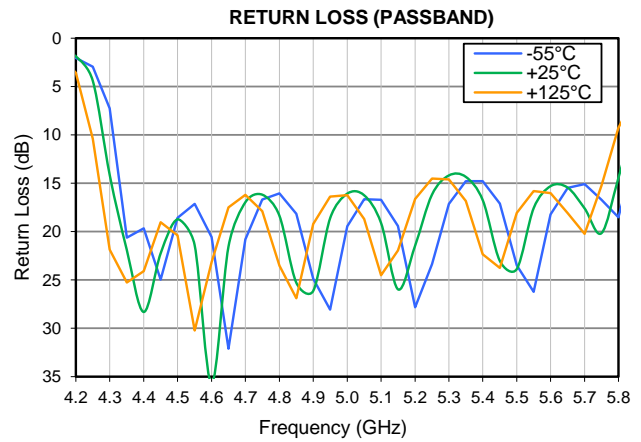
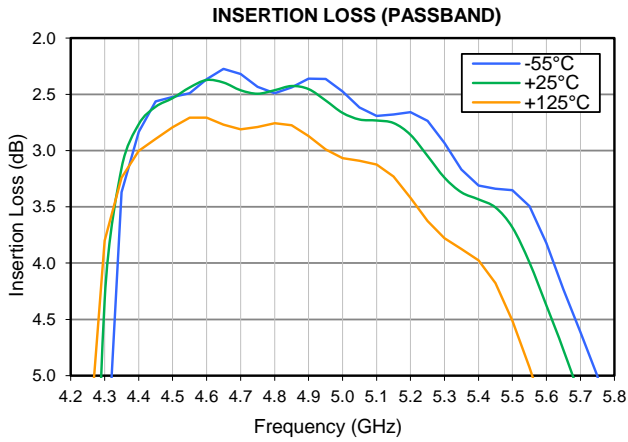
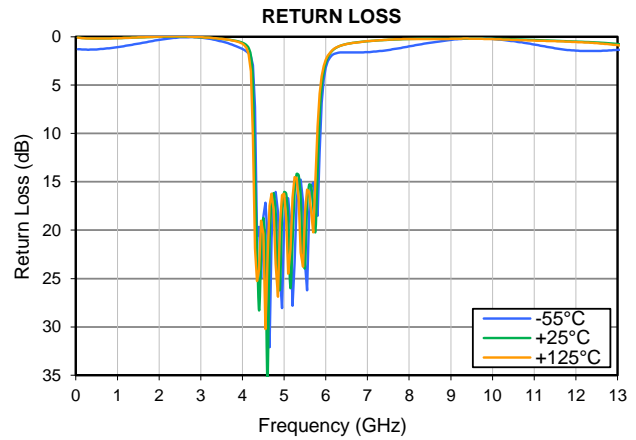
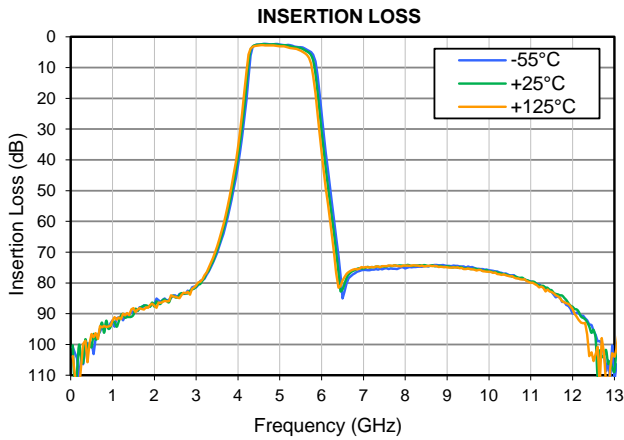

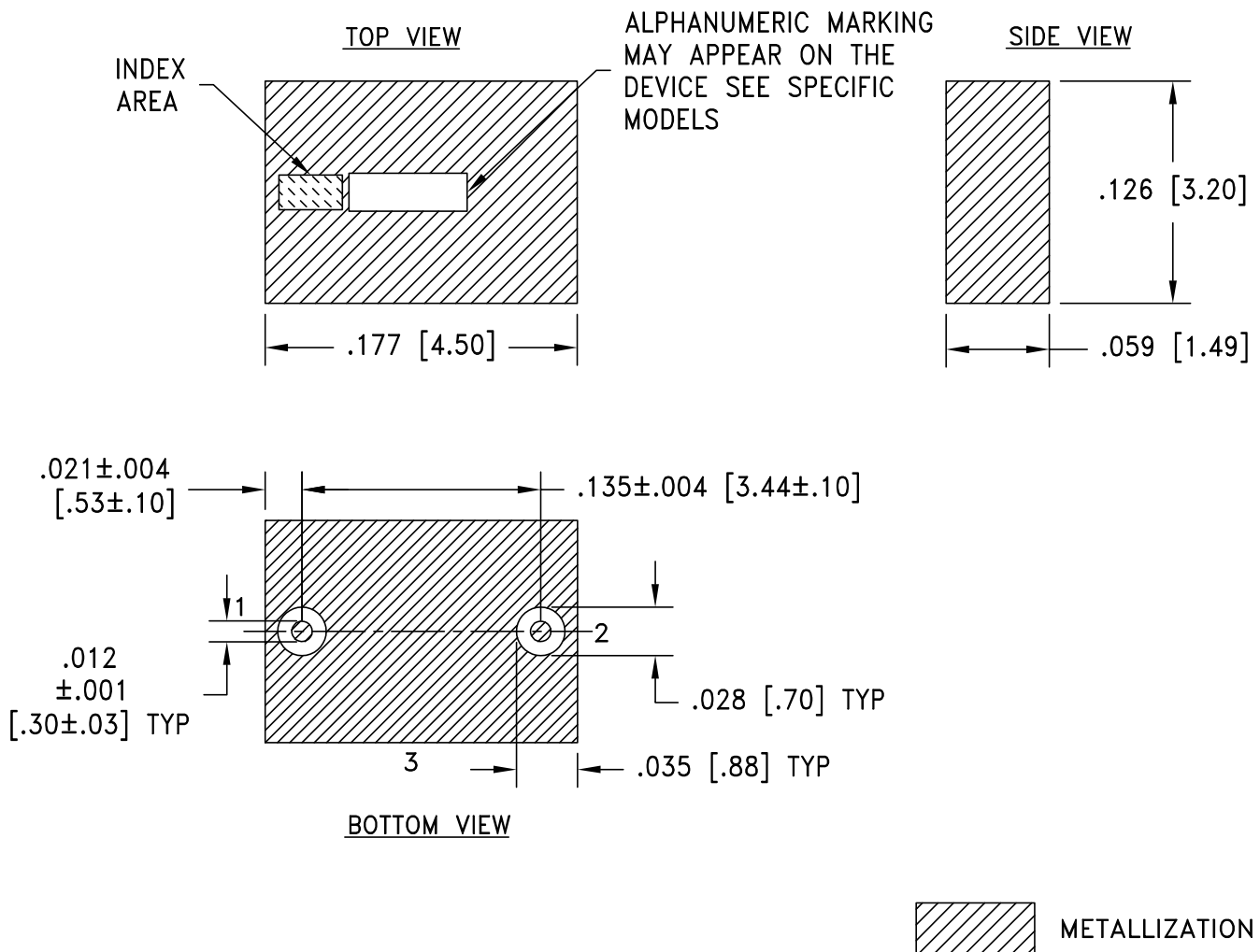

Weight: .126 grams.

Dimensions are in inches [mm]. Tolerances: 2 Pl. $\pm .01$; 3 Pl. $\pm .005$ Inches

Notes:

1. Case material: Ceramic.
2. Termination Finish: **as shown below or indicated on Data Sheet.**
For RoHS Case Styles: Tin Plate over Nickel plate. All models, (+) suffix.



P.O. Box 350166, Brooklyn, New York 11235-0003 (718) 934-4500 Fax (718) 332-4661 For detailed performance specs & shopping online see Mini-Circuits web site



The Design Engineers Search Engine Provides ACTUAL Data Instantly From MINI-CIRCUITS At: www.minicircuits.com

RF/IF MICROWAVE COMPONENTS

THIRD ANGLE PROJECTION

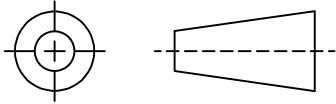

REVISIONS

REV	ECN No.	DESCRIPTION	DATE	DR	AUTH
OR	ECO-013254	NEW RELEASE	05/16/22	ITG	IL
A	ECO-015587	UPDATED STACK-UP DIAGRAM	11/01/22	ITG	IL
B	ECO-020890	ADDED DIMENSIONS	02/16/24	ITG	IL

SUGGESTED MOUNTING CONFIGURATION FOR
NM1812C-3 CASE STYLE

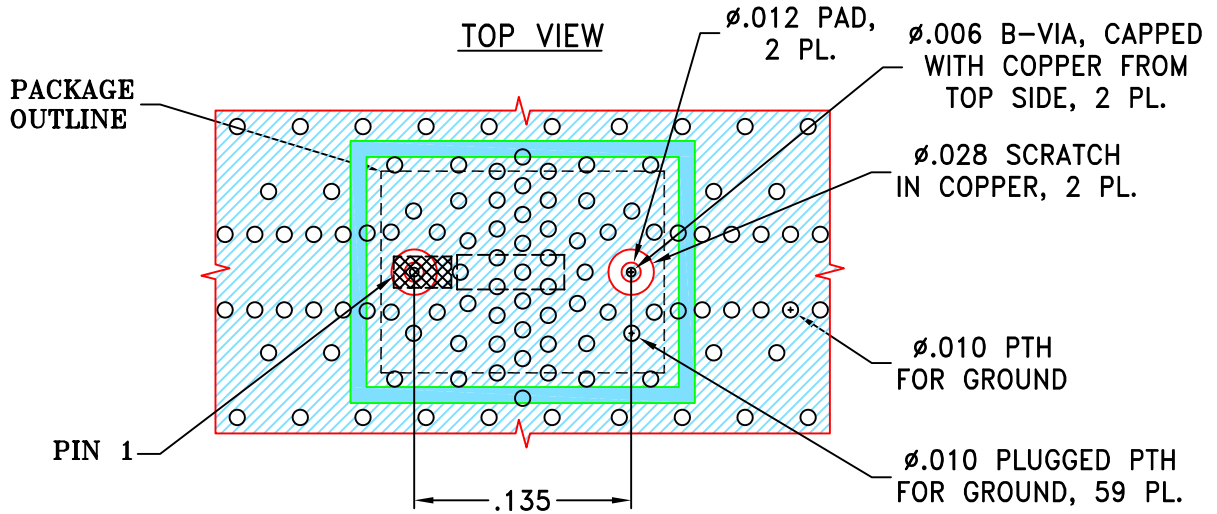

STACK-UP DIAGRAM

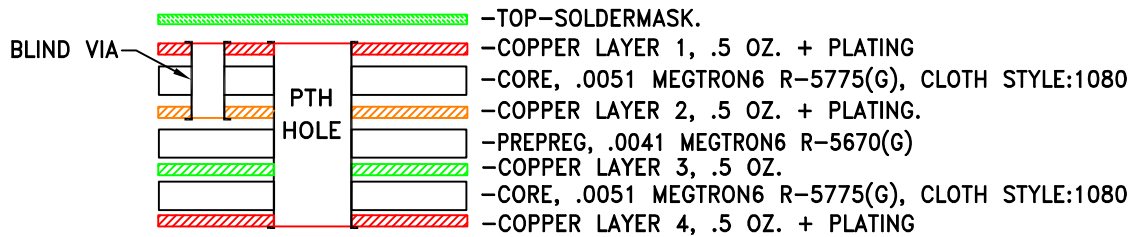

- TOTAL FINISHED THICKNESS 0.0228±.004.
- B-VIA PRESENT FROM COPPER LAYER 1 TO COPPER LAYER 2.
- PTH PRESENT FROM COPPER LAYER 1 TO COPPER LAYER 4.
- INDICATED PLUGGED PTH'S ARE PLUGGED WITH EPOXY AND CAPPED WITH COPPER FROM TOP SIDE.
- LAYER 4 IS CONTINUOUS GROUND PLANE.

NOTES:

- PCB IS MULTILAYER PCB, SEE STACK-UP DIAGRAM.
- TRACE WIDTH & GAP PARAMETERS ARE SHOWN FOR MEGTRON6 R-5775(G), CLOTH STYLE:1080 WITH DIELECTRIC THICKNESS .0051; COPPER: 1/2 OZ.+PLATING. FOR OTHER MATERIALS TRACE WIDTH AND GAP MAY NEED TO BE MODIFIED.
- COPPER LAYER 4 OF THE PCB ARE CONTINUOUS GROUND PLANE.



DENOTES PCB COPPER LAYOUT WITH SMOBC (SOLDER MASK OVER BARE COPPER)

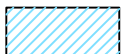

DENOTES COPPER LAND PATTERN FREE OF SOLDER MASK

UNLESS OTHERWISE SPECIFIED	INITIALS		DATE
DIMENSIONS ARE IN INCHES TOLERANCES ON: 2 PL DECIMALS ± 3 PL DECIMALS ± .005 ANGLES ± FRACTIONS ±	DRAWN	ITG	05/16/22
	CHECKED	GF	05/16/22
	APPROVED	IL	05/16/22



Mini-Circuits[®] 13 Neptune Avenue
Brooklyn NY 11235

PL, NM1812C-3, TB-1239

THIS DOCUMENT AND ITS CONTENTS ARE THE PROPERTY OF MINI-CIRCUITS. EXCEPT FOR USE EXPRESSLY GRANTED, IN WRITING, TO ITS VENDORS, VENDEE AND THE UNITED STATES GOVERNMENT, MINI-CIRCUITS RESERVES ALL PROPRIETARY DESIGN, USE, MANUFACTURING AND REPRODUCTION RIGHTS THERETO. THESE CONTENTS SHALL NOT BE USED, DUPLICATED OR DISCLOSED TO ANY OUTSIDE PARTY, IN WHOLE OR IN PART, WITHOUT WRITTEN PERMISSION OF MINI-CIRCUITS.

SIZE	CODE IDENT	DRAWING NO:	REV:
A	15542	98-PL-730	B
FILE:	98PL730	SCALE: 8:1	SHEET: 1 OF 2

LAYER 2, B-VIA & PTH

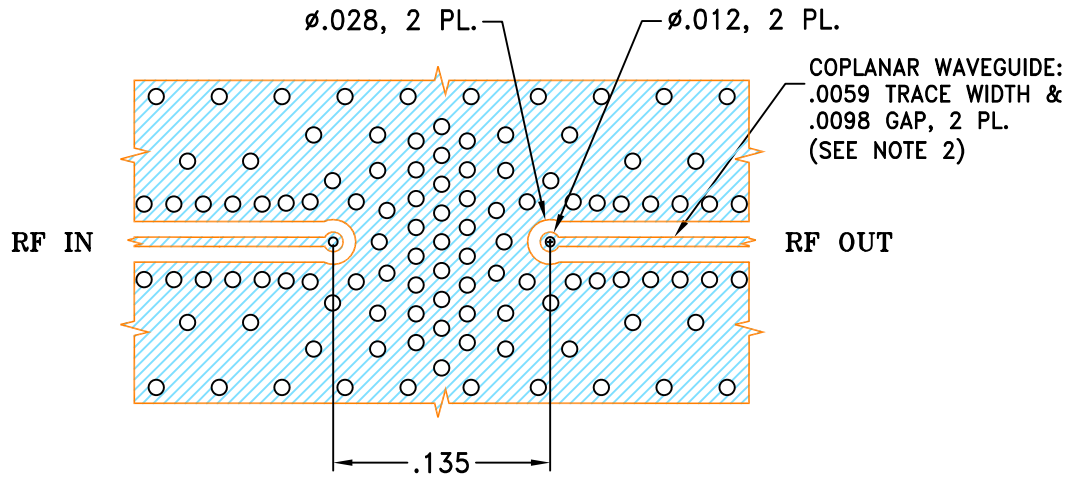

LAYER 3 & PTH

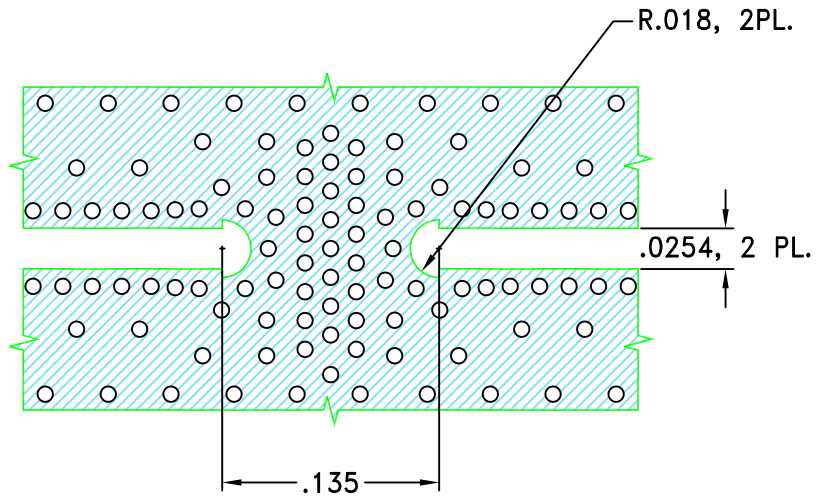

Mini-Circuits

THIS DOCUMENT AND ITS CONTENTS ARE THE PROPERTY OF MINI-CIRCUITS. EXCEPT FOR USE EXPRESSLY GRANTED, IN WRITING, TO ITS VENDORS, VENDEE AND THE UNITED STATES GOVERNMENT, MINI-CIRCUITS RESERVES ALL PROPRIETARY DESIGN, USE, MANUFACTURING AND REPRODUCTION RIGHTS THERETO. THESE CONTENTS SHALL NOT BE USED, DUPLICATED OR DISCLOSED TO ANY OUTSIDE PARTY, IN WHOLE OR IN PART, WITHOUT WRITTEN PERMISSION OF MINI-CIRCUITS.

ALL DIMENSIONS ARE IN INCHES EXCEPT OTHERWISE SPECIFIED

SIZE A	CODE IDENT 15542	DRAWING NO: 98-PL-730	REV: B
-----------	---------------------	--------------------------	-----------

FILE: 98PL730	SCALE: 8:1	SHEET: 2 OF 2
------------------	---------------	------------------

Evaluation Board and Circuit

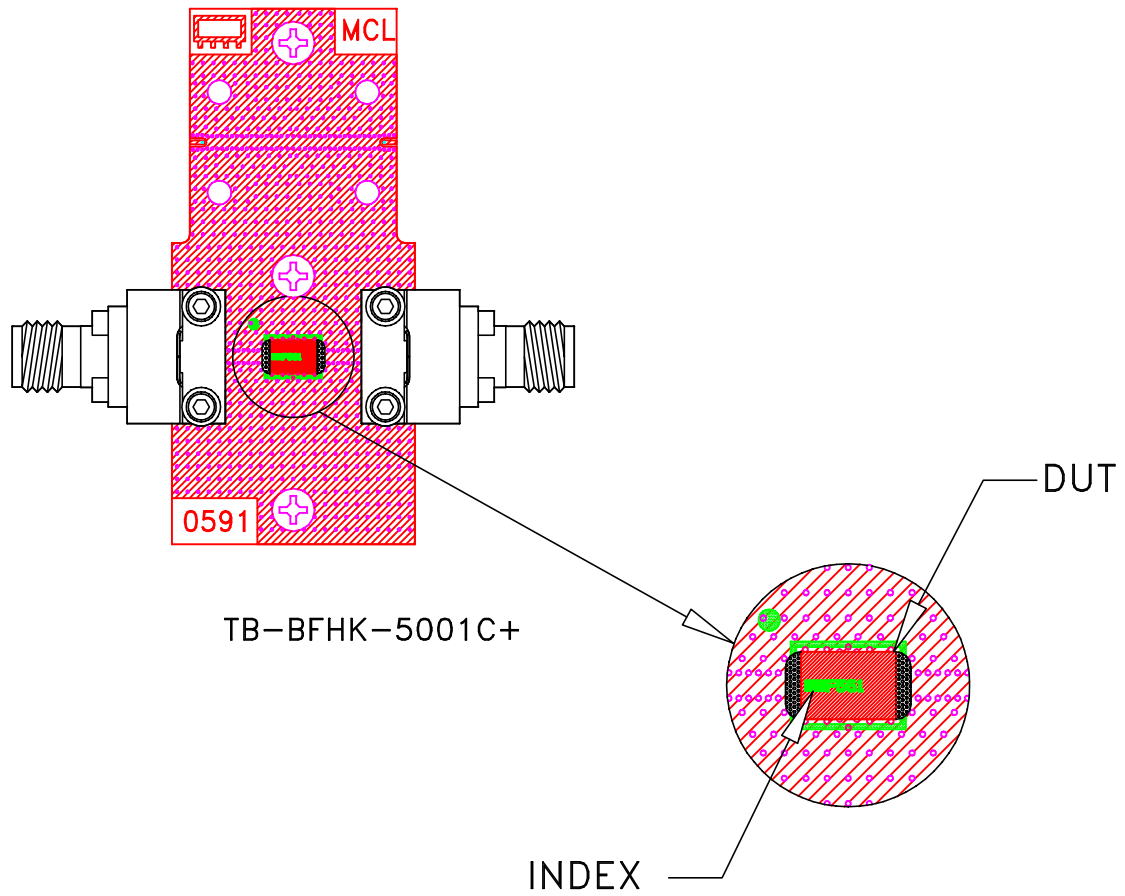

TB-BFHK-5001C+

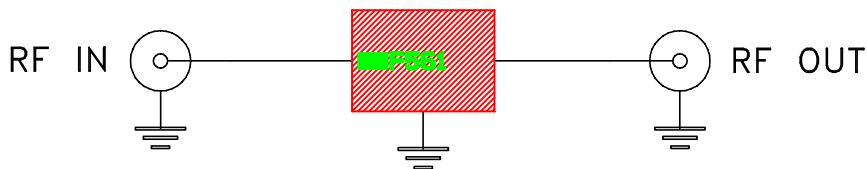

Schematic Diagram

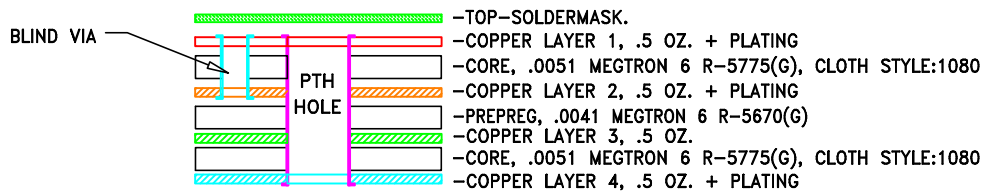

STACK-UP DIAGRAM

Notes:

1. 2.92 mm Female End Launch Connector.
2. PCB Material: Megtron 6 R5775(N).
Dielectric Constant=3.6.
3. Total finished thickness .023".

 **Mini-Circuits®**

All Mini-Circuits products are manufactured under exacting quality assurance and control standards, and are capable of meeting published specifications after being subjected to any or all of the following physical and environmental test.

Specification	Test/Inspection Condition	Reference/Spec
Operating Temperature	-55° to 125° C Ambient Environment	Individual Model Data Sheet
Storage Temperature	-55° to 125° C Ambient Environment	Individual Model Data Sheet
Thermal Cycling	-55 to 125°C, 100 cycles, Dwell Time 15 minutes.	MIL-STD-202, Method 107, Condition A-3
Humidity	85°C, 90-95% Relative Humidity, 250hours	
Solderability	10X / 30X Magnification	J-STD-002C Test S, J-STD-002C Test S1
High Temp Storage	125°C, 250 hours	
Bend Test	1mm, deflection for 5 seconds Span of bending: 2.75"	--