

LTCC Bandpass Filter

BFCN-7350+

50Ω 7150 to 7550 MHz

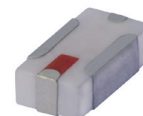

CASE STYLE: FV1206-4

The Big Deal

- Small size 3.2mm x 1.6mm
- Pass band (7150-7550 MHz)
- Low Insertion Loss (1.8 dB typical)
- Sharp rejection peaks close to stop band

Product Overview

The BFCN-7350+ LTCC Band Pass Filter is constructed with 5 layers in order to achieve a miniature size and high repeatability of performance. Wrap-around terminations minimize variations in performance due to parasitics. Covering 7350 MHz \pm 200 MHz, these units offer low insertion loss and good rejection at the band reject edges.

Key Features

Feature	Advantages
Small Size (3.20mm x1.6 mm)	Allows for high layout density of circuit boards, while minimizing affects of parasitics.
Rejection peaks close to pass band	Provides good rejection of signals close to the pass band, for improved system performance.
Wrap around termination	Provides excellent solderability and easy visual inspection capability.
LTCC construction	Provides a rugged package that is well suited for tough environments including high humidity and high temperature extremes.

Notes

A. Performance and quality attributes and conditions not expressly stated in this specification document are intended to be excluded and do not form a part of this specification document.

B. Electrical specifications and performance data contained in this specification document are based on Mini-Circuit's applicable established test performance criteria and measurement instructions.

C. The parts covered by this specification document are subject to Mini-Circuits standard limited warranty and terms and conditions (collectively, "Standard Terms"); Purchasers of this part are entitled to the rights and benefits contained therein. For a full statement of the Standard Terms and the exclusive rights and remedies thereunder, please visit Mini-Circuits' website at www.minicircuits.com/MCLStore/terms.jsp



Bandpass Filter

BFCN-7350+

50Ω 7150 to 7550 MHz

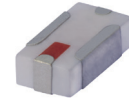

Generic photo used for illustration purposes only

CASE STYLE: FV1206-4

+RoHS Compliant

The +Suffix identifies RoHS Compliance. See our web site for RoHS Compliance methodologies and qualifications



Available Tape and Reel at no extra cost

Reel Size	Devices/Reel
7"	20, 50, 100, 200, 500, 1000, 3000

Maximum Ratings

Operating Temperature	-55°C to 100°C
Storage Temperature	-55°C to 100°C
RF Power Input*	2W max. at 25°C

*Passband rating, derate linearly to 0.5W at 100°C ambient
Permanent damage may occur if any of these limits are exceeded.

Pin Connections

RF IN	1
RF OUT	3
GROUND	2,4

Product Marking: 43

Outline Drawing

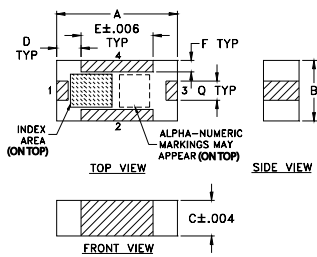

PCB Land Pattern

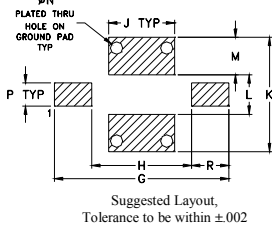

Suggested Layout, Tolerance to be within ±.002

Outline Dimensions (inch/mm)

A	B	C	D	E	F	G	H	J
.126	.063	.037	.026	.075	.012	.182	.104	.069
3.20	1.60	0.94	0.66	1.91	0.30	4.62	2.64	1.75
K	L	M	N	P	Q	R		wt
.119	.041	.039	.013	.024	.020	.039		grams
3.02	1.04	0.99	0.33	0.61	0.51	0.99		.020

Demo Board MCL P/N: TB-518+ Suggested PCB Layout (PL-305)

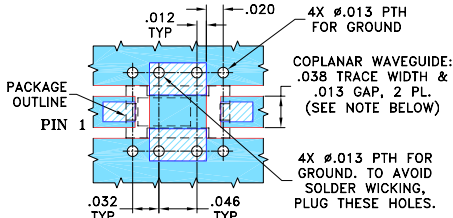

NOTE: 1. TRACE WIDTH IS SHOWN FOR ROGERS RO4350B WITH DIELECTRIC THICKNESS .020" ± .0015". COPPER: 1/2 OZ. EACH SIDE. FOR OTHER MATERIALS TRACE WIDTH MAY NEED TO BE MODIFIED.

- 2. BOTTOM SIDE OF THE PCB IS CONTINUOUS GROUND PLANE.
- DENOTES PCB COPPER LAYOUT WITH SMOBC (SOLDER MASK OVER BARE COPPER)
- DENOTES COPPER LAND PATTERN FREE OF SOLDER MASK

Notes

- A. Performance and quality attributes and conditions not expressly stated in this specification document are intended to be excluded and do not form a part of this specification document.
- B. Electrical specifications and performance data contained in this specification document are based on Mini-Circuit's applicable established test performance criteria and measurement instructions.
- C. The parts covered by this specification document are subject to Mini-Circuits standard limited warranty and terms and conditions (collectively, "Standard Terms"); Purchasers of this part are entitled to the rights and benefits contained therein. For a full statement of the Standard Terms and the exclusive rights and remedies thereunder, please visit Mini-Circuits' website at www.minicircuits.com/WCLStore/terms.jsp

Features

- Small size
- Temperature stable
- Hermetically sealed
- LTCC construction

Applications

- Harmonic Rejection
- Transmitters / Receivers

Electrical Specifications^{1,2} at 25°C

Parameter	F#	Frequency (MHz)	Min.	Typ.	Max.	Unit
Pass Band	Center Frequency	—	—	7350	—	MHz
	Insertion Loss	F1-F2	—	1.8	3.5	dB
Stop Band, Lower	VSWR	F1-F2	—	1.3	—	:1
	Insertion Loss	DC-F3	DC-6325	—	15	dB
Stop Band, Upper	VSWR	DC-F3	DC-6325	—	30	:1
	Insertion Loss	F4-F5	8700-14000	—	15	dB
Stop Band, Upper	VSWR	F4-F5	8700-14000	—	30	:1

1. Measured on Mini-Circuits Characterization Test Board TB-518+.

2. This filter is not intended for use as a DC Blocking circuit element. In Application where DC voltage is present at either input or output ports, blocking capacitors are required at the corresponding RF port.

Typical Frequency Response

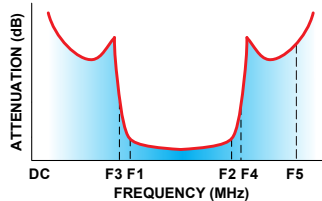

Functional Schematic

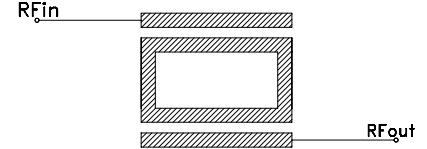

Typical Performance Data at 25°C

Frequency (MHz)	Insertion Loss (dB)	VSWR (:1)
100.00	46.71	1737.18
800.00	28.74	579.06
1500.00	23.56	217.15
2550.00	19.77	102.19
5000.00	17.29	34.75
6050.00	21.72	42.38
6750.00	7.32	32.79
7100.00	1.84	5.72
7300.00	1.81	1.96
8000.00	6.33	4.24
9000.00	24.85	22.58
10050.00	14.90	23.49
12050.00	17.49	10.02
13050.00	20.61	7.70
14050.00	20.66	6.76

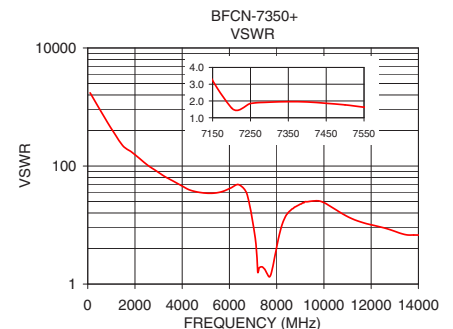
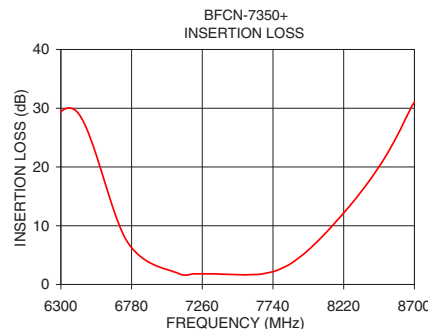
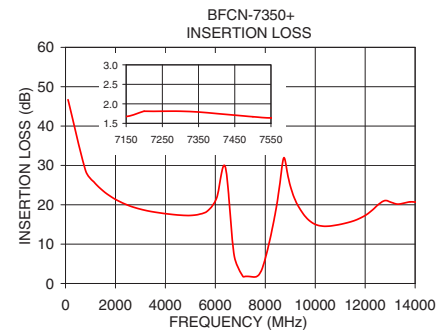

Typical Performance Data

FREQUENCY (MHz)	INSERTION LOSS (dB)	RETURN LOSS (dB)	FREQUENCY (MHz)	GROUP DELAY (ns)
100.0	46.71	0.01	100.00	0.25
450.0	33.67	0.03	450.00	0.25
800.0	28.74	0.05	800.0	0.25
1500.0	23.56	0.10	1500.0	0.25
2200.0	20.72	0.17	2200.0	0.25
2900.0	19.06	0.26	2550.0	0.25
3600.0	18.10	0.37	2900.0	0.25
4300.0	17.52	0.48	3250.0	0.24
4650.0	17.34	0.50	3600.0	0.24
5000.0	17.29	0.50	3950.0	0.24
5350.0	17.57	0.47	4300.0	0.24
5700.0	18.50	0.41	4650.0	0.24
6050.0	21.72	0.36	5000.0	0.25
6400.0	29.62	0.53	5350.0	0.25
6750.0	7.32	3.07	5700.0	0.26
7100.0	1.84	12.90	6050.0	0.26
7200.0	1.81	10.49	6750.0	0.64
7250.0	1.81	9.96	7100.0	0.73
7300.0	1.81	9.78	7200.0	0.62
7350.0	1.79	9.90	7250.0	0.57
7400.0	1.75	10.43	7300.0	0.55
7450.0	1.71	11.13	7350.0	0.54
7500.0	1.67	12.44	7400.0	0.55
7550.0	1.64	14.16	7450.0	0.56
7600.0	1.68	16.26	7500.0	0.56
7650.0	1.74	17.04	7550.0	0.59
7700.0	1.95	14.88	7600.0	0.61
7750.0	2.25	11.73	7650.0	0.65
7800.0	2.76	9.04	7700.0	0.66
7850.0	3.38	6.92	7750.0	0.69
7900.0	4.24	5.37	7800.0	0.69
7950.0	5.21	4.18	7850.0	0.69
8000.0	6.33	3.32	7900.0	0.65
8050.0	7.53	2.67	7950.0	0.61
8100.0	8.82	2.23	8000.0	0.58
8150.0	10.18	1.87	8050.0	0.52
8200.0	11.59	1.63	8100.0	0.49
8250.0	13.05	1.44	8150.0	0.42
8300.0	14.55	1.30	8200.0	0.41
8350.0	16.18	1.19	8250.0	0.35
8400.0	17.84	1.12	8300.0	0.33
8500.0	21.61	1.01	8350.0	0.26
8600.0	26.13	0.93	8400.0	0.25
8700.0	31.01	0.87	8450.0	0.17
8800.0	31.08	0.83	8500.0	0.12
8900.0	27.60	0.79	9000.0	0.03
9000.0	24.85	0.76	9050.0	0.11
9100.0	22.78	0.73	9100.0	0.15
9200.0	21.21	0.70	9200.0	0.19
9300.0	19.88	0.68	9300.0	0.22
9800.0	15.79	0.74	9800.0	0.31
10300.0	14.57	0.98	10300.0	0.30
10800.0	14.79	1.28	10800.0	0.27
11300.0	15.47	1.54	11300.0	0.26
11800.0	16.61	1.74	11800.0	0.26
12300.0	18.73	1.95	12300.0	0.21
12800.0	21.08	2.27	12800.0	0.09
13300.0	20.16	2.58	13300.0	0.24
13800.0	20.75	2.59	13800.0	0.19
14050.0	20.66	2.67	14050.0	0.17

Typical Performance Curves

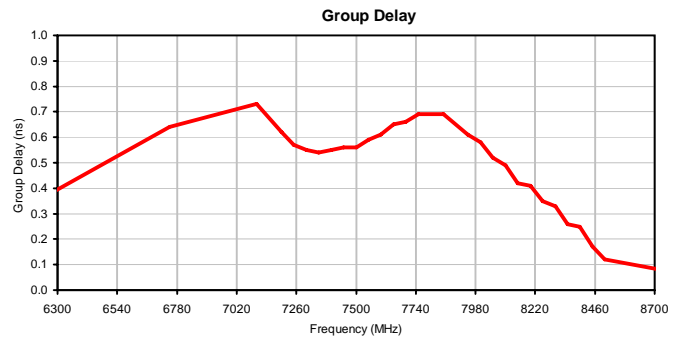
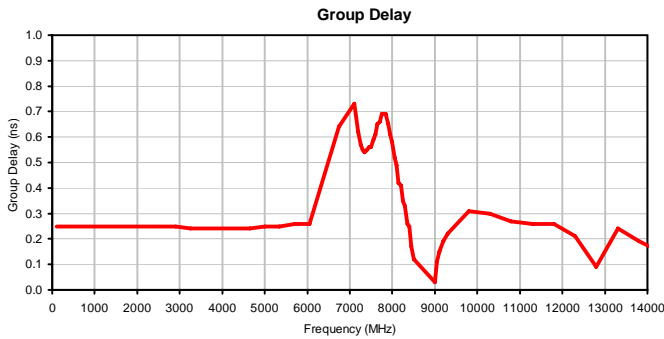
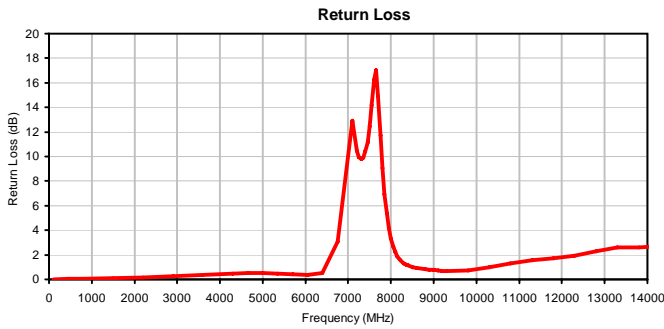

P.O. Box 350166, Brooklyn, New York 11235-0003 (718) 934-4500 • Fax (718) 332-4661 For detailed performance specs & shopping online see Mini-Circuits web site
 The Design Engineers Search Engine Provides ACTUAL Data Instantly From MINI-CIRCUITS At: www.minicircuits.com



IF/RF MICROWAVE COMPONENTS

Outline Dimensions

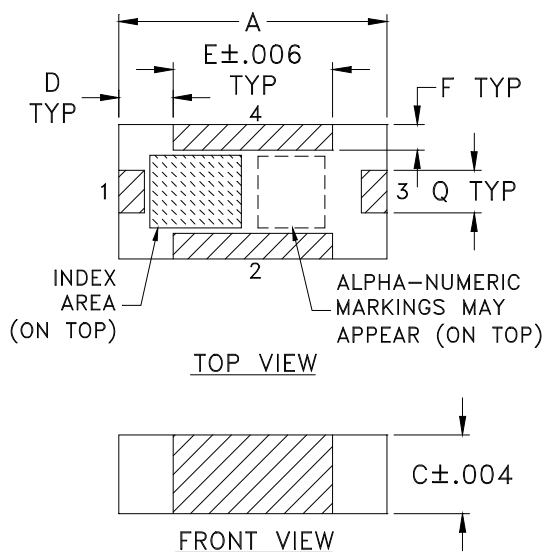

PCB Land Pattern

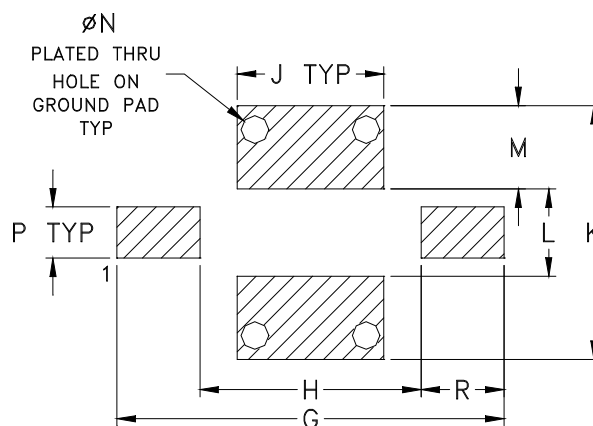

CASE #	A	B	C	D	E	F	G	H	J	K	L	M
FV1206-4	.126 (3.20)	.063 (1.60)	.037 (0.94)	.026 (0.66)	.075 (1.91)	.012 (0.30)	.182 (4.62)	.104 (2.64)	.069 (1.75)	.119 (3.02)	.041 (1.04)	.039 (0.99)

CASE #	N	P	Q	R	WT. GRAM
FV1206-4	.013 (0.33)	.024 (0.61)	.020 (0.51)	.039 (0.99)	.020

Dimensions are in inches (mm). Tolerances: 2 Pl. $\pm .01$; 3 Pl. $\pm .005$

Notes:

- Open style, ceramic base.
- Termination finish: **as shown below or indicated on Data Sheet.**
 For RoHS Case Styles: Tin plate over Nickel plate. All models, (+) suffix.
 For RoHS-5 Case Styles: Tin-Lead plate. All models, no (+) suffix.



P.O. Box 350166, Brooklyn, New York 11235-0003 (718) 934-4500 Fax (718) 332-4661 For detailed performance specs & shopping online see Mini-Circuits web site



The Design Engineers Search Engine Provides ACTUAL Data Instantly From MINI-CIRCUITS At: www.minicircuits.com

RF/IF MICROWAVE COMPONENTS

DEVICE ORIENTATION IN T&R

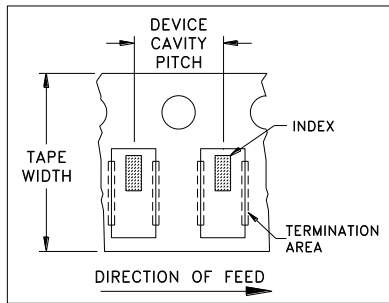

ILLUSTRATION 1

Applicable Case Styles
FV1206-1 FV1206-3

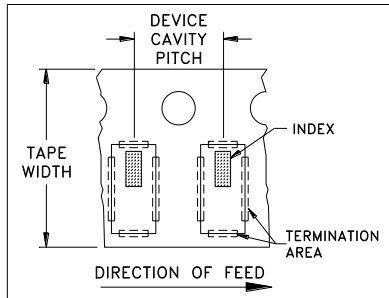

ILLUSTRATION 2

Applicable Case Styles
FV1206-4 FV1206-5 FV1206-6 FV1206-7 FV1206-9

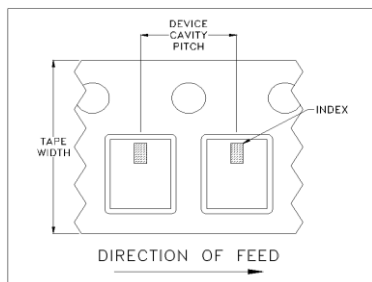

ILLUSTRATION 3

Applicable Case Styles
FV1206-12 GE0805C-18 NL1008C-6 NL1008C-7 NL1008C-9 NL1008C-10

Tape Width, mm	Device Cavity Pitch, mm	Reel Size, inches	Devices per Reel	
8	4	7	Small quantity standards (see note)	20
				50
				100
				200
				500
			1000	
			Standard	3000

Note: Please consult individual model data sheet to determine device per reel availability.

Mini-Circuits carrier tape materials provide protection from ESD (Electro-Static Discharge) during handling and transportation. Tapes are static dissipative and comply with industry standards EIA-481/EIA-541.

Go to: www.minicircuits.com/pages/pdfs/tape.pdf

Mini-Circuits ISO 9001 & ISO 14001 Certified

Mini-Circuits[®]

INTERNET <http://www.minicircuits.com>

P.O. Box 350166, Brooklyn, New York 11235-0003 (718) 934-4500 Fax (718) 332-4661

Distribution Centers NORTH AMERICA 800-654-7949 • 417-335-5935 • Fax 417-335-5945 • EUROPE 44-1252-832600 • Fax 44-1252-837010

Mini-Circuits ISO 9001 & ISO 14001 Certified

THIRD ANGLE PROJECTION

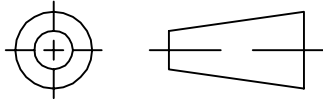

REVISIONS

REV	ECN No.	DESCRIPTION	DATE	DR	AUTH
OR	M123589	NEW RELEASE	01/15/09	AV	ABD

SUGGESTED MOUNTING CONFIGURATION
FOR FV1206-4 CASE STYLE, "04FL01" PIN CODE

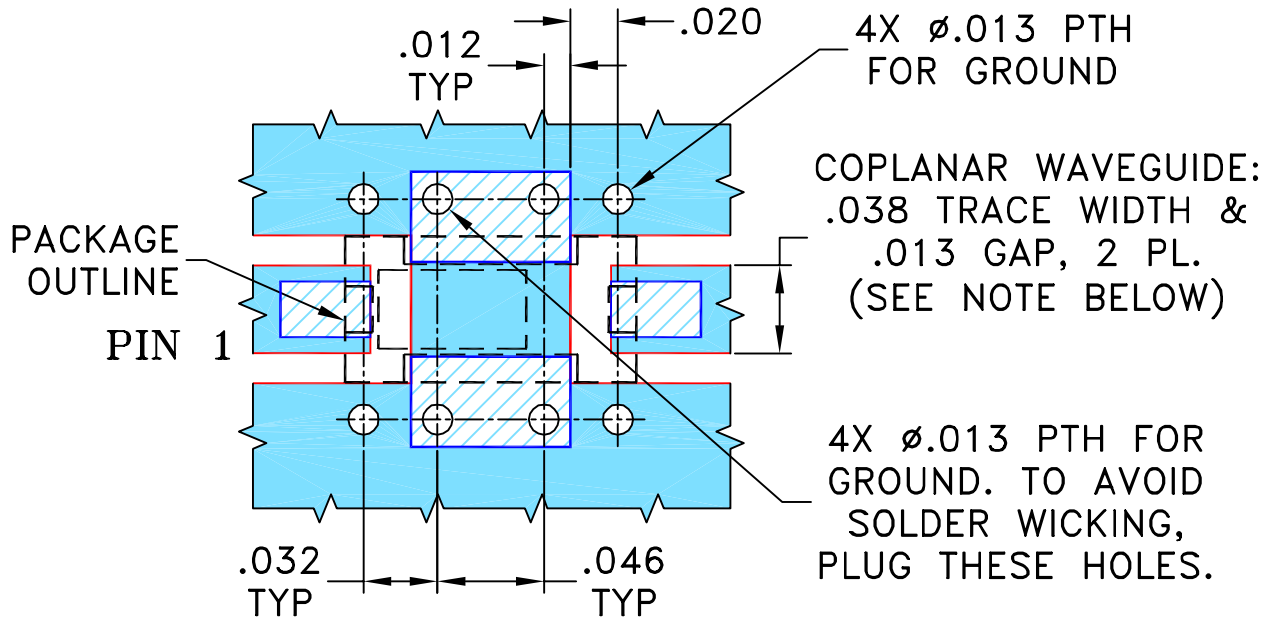

- NOTE:** 1. TRACE WIDTH IS SHOWN FOR ROGERS R04350B WITH DIELECTRIC THICKNESS .020" ± .0015". COPPER: 1/2 OZ. EACH SIDE. FOR OTHER MATERIALS TRACE WIDTH MAY NEED TO BE MODIFIED.
2. BOTTOM SIDE OF THE PCB IS CONTINUOUS GROUND PLANE.



DENOTES PCB COPPER LAYOUT WITH SMOBC (SOLDER MASK OVER BARE COPPER)

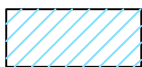

DENOTES COPPER LAND PATTERN FREE OF SOLDER MASK

UNLESS OTHERWISE SPECIFIED

INITIALS

DATE

DIMENSIONS ARE IN INCHES

DRAWN

AV

07/10/09

TOLERANCES ON:

CHECKED

IL

01/15/09

2 PL DECIMALS ±

APPROVED

ABD

01/15/09

3 PL DECIMALS ± .005

ANGLES ±

FRACTIONS ±

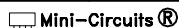

THIS DOCUMENT AND ITS CONTENTS ARE THE PROPERTY OF MINI-CIRCUITS. EXCEPT FOR USE EXPRESSLY GRANTED, IN WRITING, TO ITS VENDORS, VENDEE AND THE UNITED STATES GOVERNMENT, MINI-CIRCUITS RESERVES ALL PROPRIETARY DESIGN, USE, MANUFACTURING AND REPRODUCTION RIGHTS THERETO. THESE CONTENTS SHALL NOT BE USED, DUPLICATED OR DISCLOSED TO ANY OUTSIDE PARTY, IN WHOLE OR IN PART, WITHOUT WRITTEN PERMISSION OF MINI-CIRCUITS.

ASHEETA1.DWG REV:A DATE:01/12/95



Mini-Circuits®

13 Neptune Avenue
Brooklyn NY 11235

PL, 04FL01, FV1206-4, BFCN, TB-518+

SIZE
A

CODE IDENT
15542

DRAWING NO:

98-PL-305

REV:

OR

FILE: 98PL305

SCALE:

12:1

SHEET:

1 OF 1

Evaluation Board and Circuit

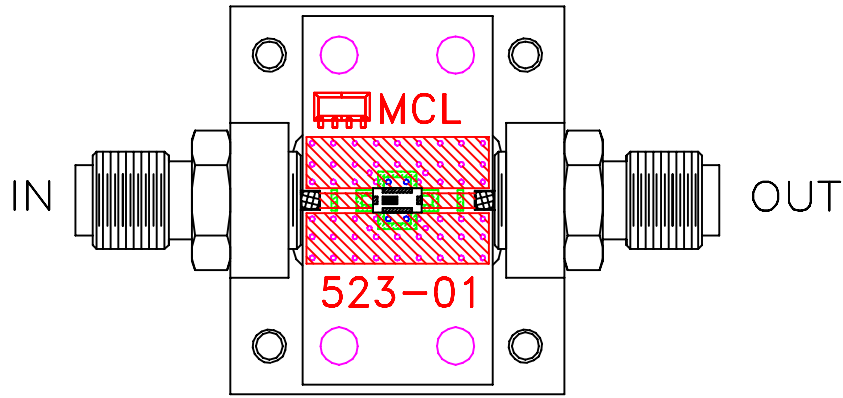

TB-518+

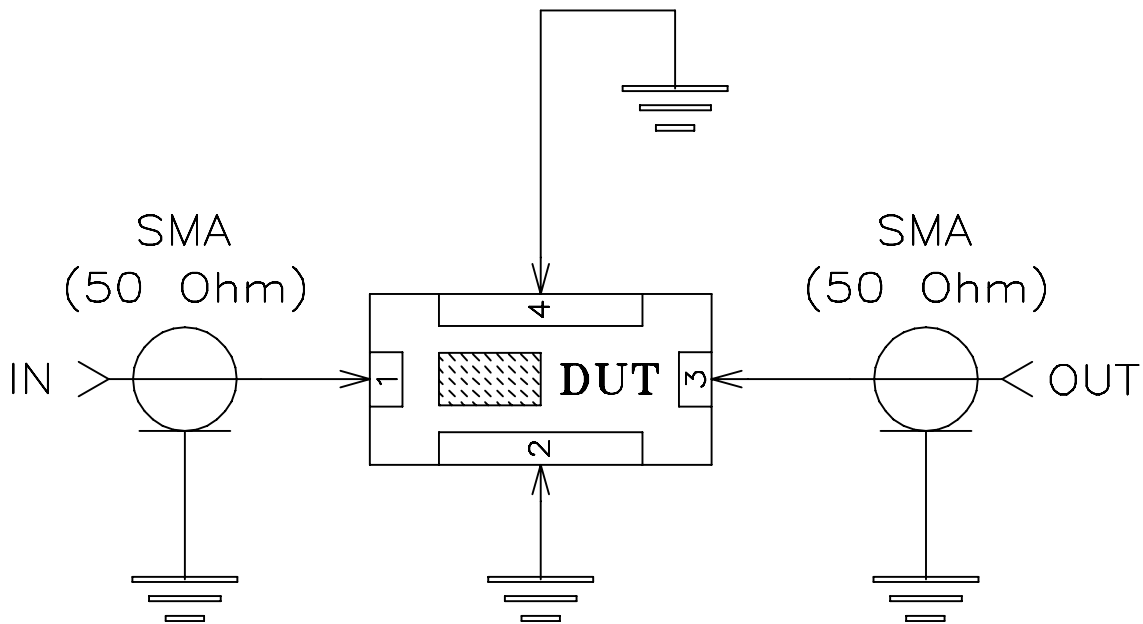

Schematic Diagram

Notes:

1. 50 Ohm SMA Female connectors.
2. PCB Material: R04350 or equivalent,
Dielectric Constant=3.5, Thickness=.020 inch.

 Mini-Circuits®



All Mini-Circuits products are manufactured under exacting quality assurance and control standards, and are capable of meeting published specifications after being subjected to any or all of the following physical and environmental test.

Specification	Test/Inspection Condition	Reference/Spec
Operating Temperature	-55° to 100°C Ambient Environment	Individual Model Data Sheet
Storage Temperature	-55° to 100° C Ambient Environment	Individual Model Data Sheet
Barometric Pressure	100,000 Feet	MIL-STD-202, Method 105, Condition D
Humidity	90% RH, 65°C Units may require bake-out after humidity to restore full performance.	MIL-STD-202, Method 103
Thermal Shock	-65° to 125°C, 5 cycles	MIL-STD-202, Method 107, Condition B
Vibration (High Frequency)	20g peak, 10-2000 Hz, 12 times in each of three perpendicular directions (total 36)	MIL-STD-202, Method 204, Condition D
Mechanical Shock	100g, 6ms sawtooth, 3 shocks each direction 3 axes (total 18)	MIL-STD-202, Method 213, Condition I