

# Ceramic Bandpass Filter

## BFCN-5750+

50Ω 5650 to 5850 MHz

### Features

- Passband VSWR, 1.2:1
- Small size (0.126"x0.063"x0.037")
- Temperature stable
- Hermetically sealed
- LTCC construction

### Applications

- WiFi
- WLAN
- Harmonic Rejection

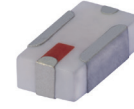

Generic photo used for illustration purposes only

CASE STYLE: FV1206-4

**+RoHS Compliant**

The +Suffix identifies RoHS Compliance. See our web site for RoHS Compliance methodologies and qualifications



Available Tape and Reel at no extra cost

Reel Size	Devices/Reel
7"	20, 50, 100, 200, 500, 1000, 3000

### Specification Definition

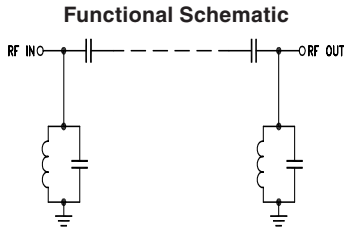
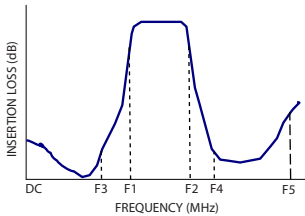

### Functional Schematic

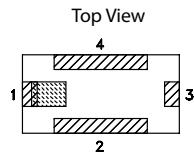

### Pad Connections

Input	1
Output	3
Ground	2,4

### Electrical Specifications<sup>1,2</sup> at 25°C

Parameter	F#	Frequency (MHz)	Min.	Typ.	Max.	Unit	
Pass Band	Center Frequency	—	—	5750	—	MHz	
	Insertion Loss	F1 - F2	5650 - 5850	—	1.85	2.5	dB
	VSWR	F1 - F2	5650 - 5850	—	1.25	—	:1
Stop Band, Lower	Insertion Loss	DC - F3	—	—	25	dB	
	VSWR	DC - F3	—	—	30	:1	
Stop Band, Upper	Insertion Loss	F4 - F5	8000 - 9500	—	25	dB	
	VSWR	F4 - F5	8000 - 9500	—	50	:1	

1. Measured on Mini-Circuits Characterization Test Board TB-518+.

2. This filter is not intended for use as a DC Blocking circuit element. In Application where DC voltage is present at either input or output ports, blocking capacitors are required at the corresponding RF port.

### Maximum Ratings

Operating Temperature	-40°C to +85°C
Storage Temperature	-55°C to +100°C
RF Power Input*	2W at 25°C

\*Passband rating, derate linearly to 0.5W at 85°C ambient  
Permanent damage may occur if any of these limits are exceeded.

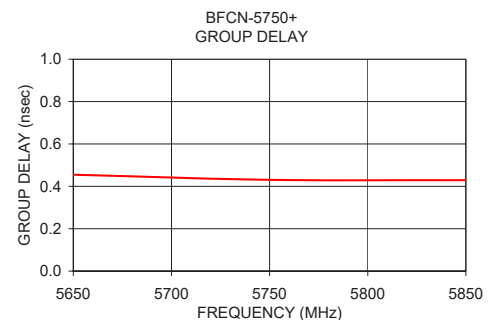
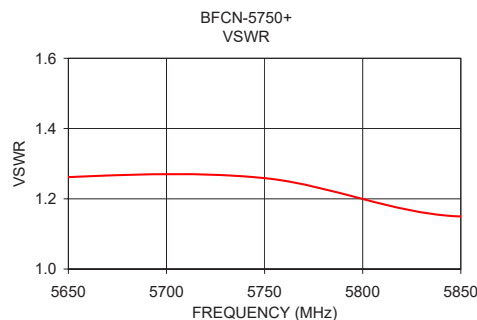
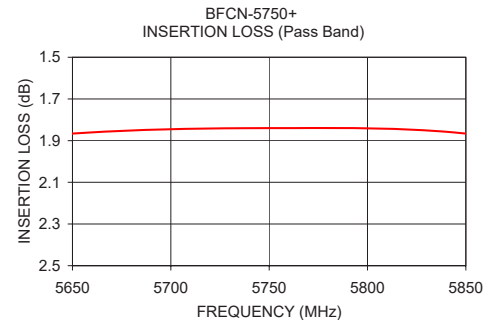
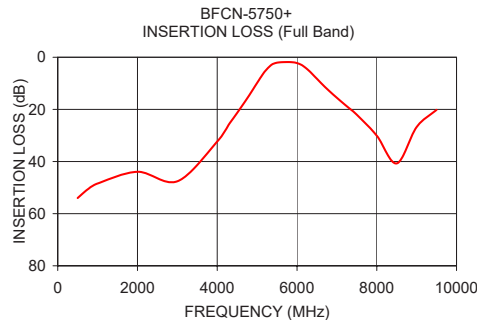

### Full Band Performance

Frequency (MHz)	Insertion Loss (dB)	VSWR (:1)
500.00	54.00	72.02
1000.00	48.44	61.34
2000.00	43.94	53.75
4300.00	25.62	30.28
5200.00	5.33	4.06
5650.00	1.87	1.26
5750.00	1.84	1.26
5850.00	1.87	1.15
6300.00	5.19	4.26
8000.00	30.11	499.57
9000.00	26.78	402.78
9500.00	20.18	73.66

### Pass Band Performance

Frequency (MHz)	Insertion Loss (dB)	Group Delay (nsec)
5650.00	1.87	0.45
5750.00	1.84	0.43
5850.00	1.87	0.43

### Pad Connections

Input	1
Output	3
Ground	2,4

### Outline Drawing

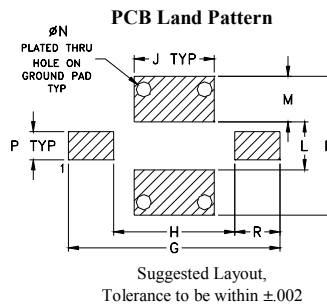
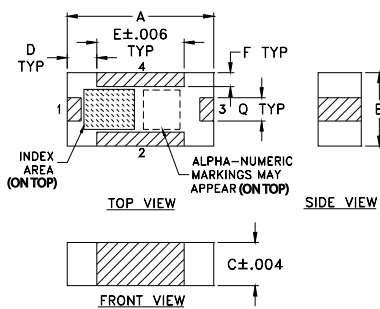

### Demo Board MCL P/N: TB-518+ Suggested PCB Layout (PL-305)

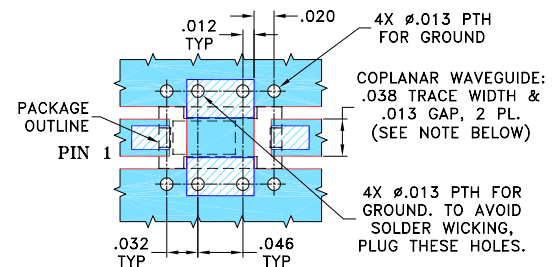

NOTE: 1. TRACE WIDTH IS SHOWN FOR ROGERS R04350B WITH DIELECTRIC THICKNESS .020" ± .0015". COPPER: 1/2 OZ. EACH SIDE. FOR OTHER MATERIALS TRACE WIDTH MAY NEED TO BE MODIFIED.

2. BOTTOM SIDE OF THE PCB IS CONTINUOUS GROUND PLANE.

- DENOTES PCB COPPER LAYOUT WITH SMOBC (SOLDER MASK OVER BARE COPPER)
- DENOTES COPPER LAND PATTERN FREE OF SOLDER MASK

### Outline Dimensions (inch/mm)

A	B	C	D	E	F	G	H	J
.126	.063	.037	.026	.075	.012	.182	.104	.069
3.20	1.60	0.94	0.66	1.91	0.30	4.62	2.64	1.75
K	L	M	N	P	Q	R		wt
.119	.041	.039	.013	.024	.020	.039		grams
3.02	1.04	0.99	0.33	0.61	0.51	0.99		.020

### Additional Notes

- Performance and quality attributes and conditions not expressly stated in this specification document are intended to be excluded and do not form a part of this specification document.
- Electrical specifications and performance data contained in this specification document are based on Mini-Circuit's applicable established test performance criteria and measurement instructions.
- The parts covered by this specification document are subject to Mini-Circuits standard limited warranty and terms and conditions (collectively, "Standard Terms"); Purchasers of this part are entitled to the rights and benefits contained therein. For a full statement of the Standard Terms and the exclusive rights and remedies thereunder, please visit Mini-Circuits' website at [www.minicircuits.com/MCLStore/terms.jsp](http://www.minicircuits.com/MCLStore/terms.jsp)

# Ceramic Bandpass Filter

# BFCN-5750+

## Typical Performance Data

FREQUENCY (MHz)	INSERTION LOSS (dB)	RETURN LOSS (dB)	GROUP DELAY (ns)
500.0	54.00	0.24	0.00
750.0	50.70	0.26	0.00
1000.0	48.44	0.28	0.01
2000.0	43.94	0.32	0.00
4300.0	25.62	0.57	0.05
4400.0	23.46	0.62	0.07
4500.0	21.31	0.67	0.10
4600.0	19.14	0.75	0.11
4700.0	16.92	0.86	0.13
4800.0	14.62	1.03	0.17
4900.0	12.25	1.33	0.21
5000.0	9.84	1.81	0.27
5100.0	7.49	2.72	0.35
5200.0	5.33	4.37	0.44
5350.0	3.02	9.50	0.53
5450.0	2.27	15.69	0.54
5550.0	1.97	20.38	0.50
5650.0	1.87	18.73	0.45
5750.0	1.84	18.81	0.43
5850.0	1.87	23.15	0.43
5950.0	2.03	19.88	0.45
6050.0	2.48	12.17	0.46
6150.0	3.31	7.81	0.45
6300.0	5.19	4.15	0.40
6500.0	8.26	2.02	0.30
6700.0	11.37	1.10	0.20
6900.0	14.24	0.64	0.14
7100.0	16.89	0.38	0.10
7300.0	19.44	0.21	0.08
7500.0	22.05	0.11	0.06
8000.0	30.11	0.03	0.02
9500.0	20.18	0.24	0.05



## Typical Performance Curves

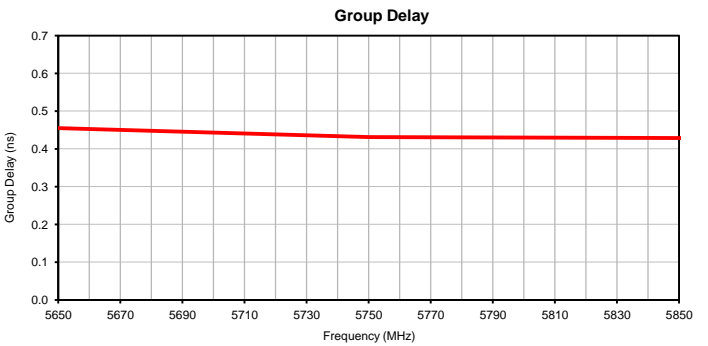
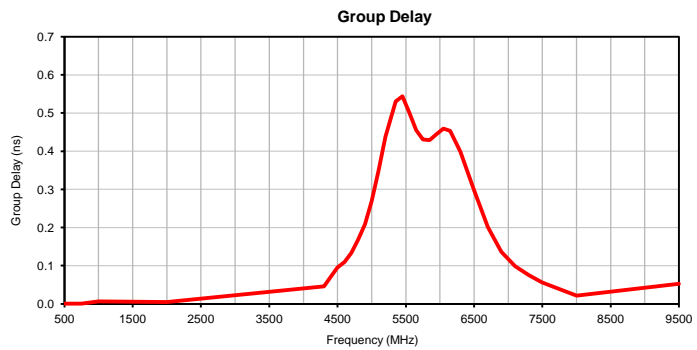
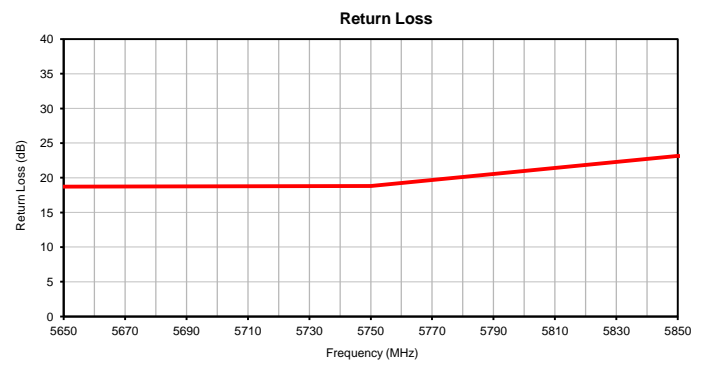
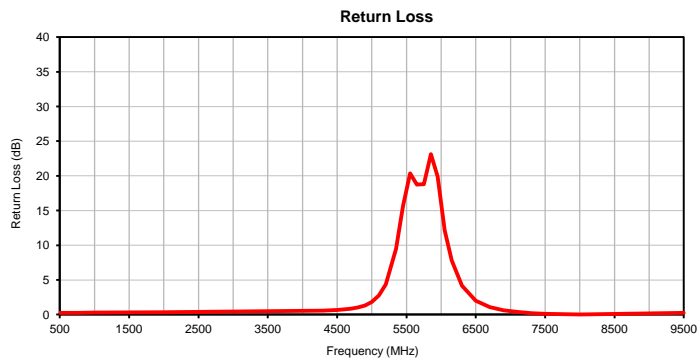
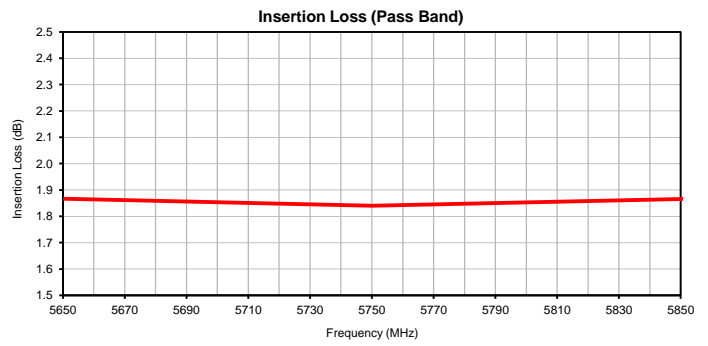
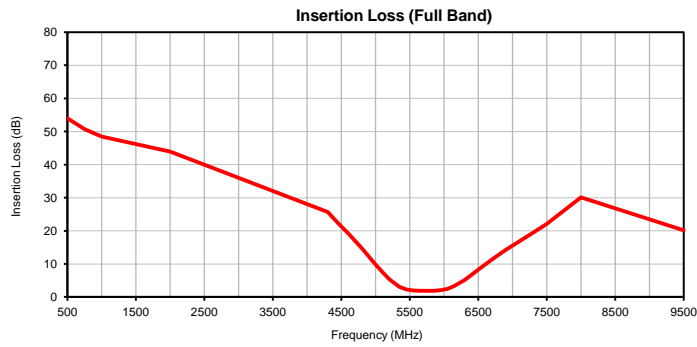

### Outline Dimensions

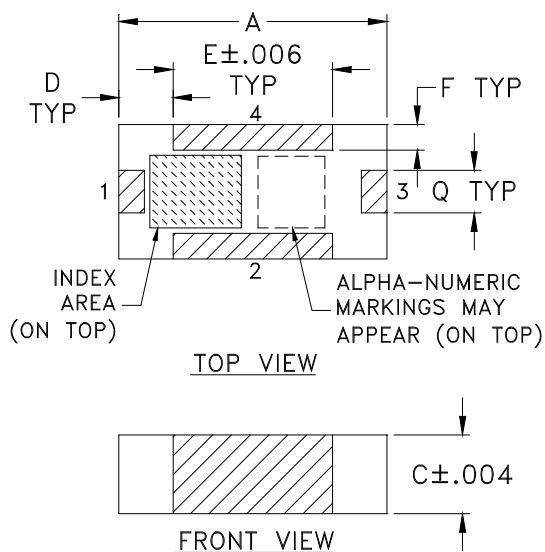

### PCB Land Pattern

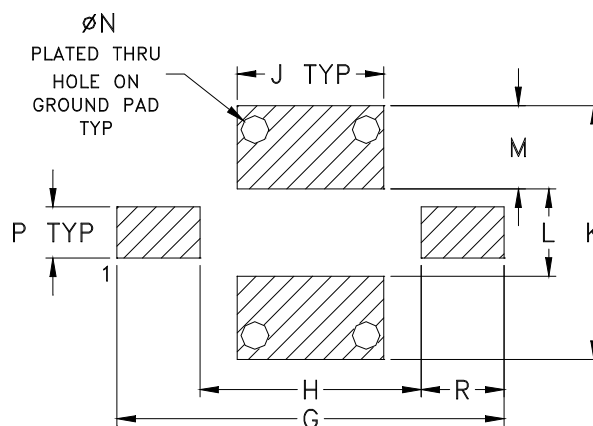

Suggested Layout,  
Tolerance to be within  $\pm .002$

CASE #	A	B	C	D	E	F	G	H	J	K	L	M
FV1206-4	.126 (3.20)	.063 (1.60)	.037 (0.94)	.026 (0.66)	.075 (1.91)	.012 (0.30)	.182 (4.62)	.104 (2.64)	.069 (1.75)	.119 (3.02)	.041 (1.04)	.039 (0.99)

CASE #	N	P	Q	R	WT. GRAM
FV1206-4	.013 (0.33)	.024 (0.61)	.020 (0.51)	.039 (0.99)	.020

Dimensions are in inches (mm). Tolerances: 2 Pl.  $\pm .01$ ; 3 Pl.  $\pm .005$

#### Notes:

- Open style, ceramic base.
- Termination finish: **as shown below or indicated on Data Sheet.**  
For RoHS Case Styles: Tin plate over Nickel plate. All models, (+) suffix.  
For RoHS-5 Case Styles: Tin-Lead plate. All models, no (+) suffix.



P.O. Box 350166, Brooklyn, New York 11235-0003 (718) 934-4500 Fax (718) 332-4661 For detailed performance specs & shopping online see Mini-Circuits web site



The Design Engineers Search Engine Provides ACTUAL Data Instantly From MINI-CIRCUITS At: [www.minicircuits.com](http://www.minicircuits.com)

RF/IF MICROWAVE COMPONENTS

## DEVICE ORIENTATION IN T&R

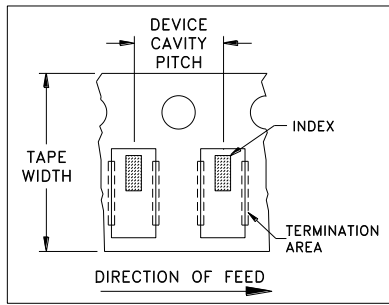

ILLUSTRATION 1

### Applicable Case Styles

FV1206-1  
FV1206-3

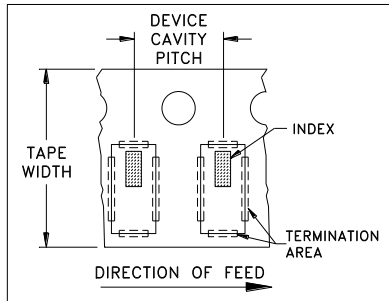

ILLUSTRATION 2

### Applicable Case Styles

FV1206-4  
FV1206-5  
FV1206-6  
FV1206-7  
FV1206-9

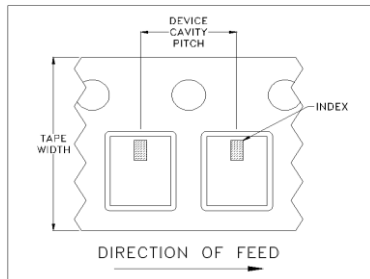

ILLUSTRATION 3

### Applicable Case Styles

FV1206-12  
GE0805C-18  
NL1008C-6  
NL1008C-7  
NL1008C-9  
NL1008C-10

Tape Width, mm	Device Cavity Pitch, mm	Reel Size, inches	Devices per Reel	
8	4	7	Small quantity standards (see note)	20
				50
				100
				200
				500
			1000	
			Standard	3000

Note: Please consult individual model data sheet to determine device per reel availability.

Mini-Circuits carrier tape materials provide protection from ESD (Electro-Static Discharge) during handling and transportation. Tapes are static dissipative and comply with industry standards EIA-481/EIA-541.

Go to: [www.minicircuits.com/pages/pdfs/tape.pdf](http://www.minicircuits.com/pages/pdfs/tape.pdf)

Mini-Circuits ISO 9001 & ISO 14001 Certified

**Mini-Circuits**<sup>®</sup>

INTERNET <http://www.minicircuits.com>

P.O. Box 350166, Brooklyn, New York 11235-0003 (718) 934-4500 Fax (718) 332-4661

Distribution Centers NORTH AMERICA 800-654-7949 • 417-335-5935 • Fax 417-335-5945 • EUROPE 44-1252-832600 • Fax 44-1252-837010

Mini-Circuits ISO 9001 & ISO 14001 Certified

THIRD ANGLE PROJECTION

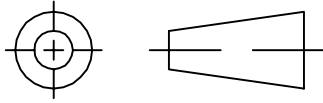

REVISIONS

REV	ECN No.	DESCRIPTION	DATE	DR	AUTH
OR	M123589	NEW RELEASE	01/15/09	AV	ABD

**SUGGESTED MOUNTING CONFIGURATION  
FOR FV1206-4 CASE STYLE, "04FL01" PIN CODE**

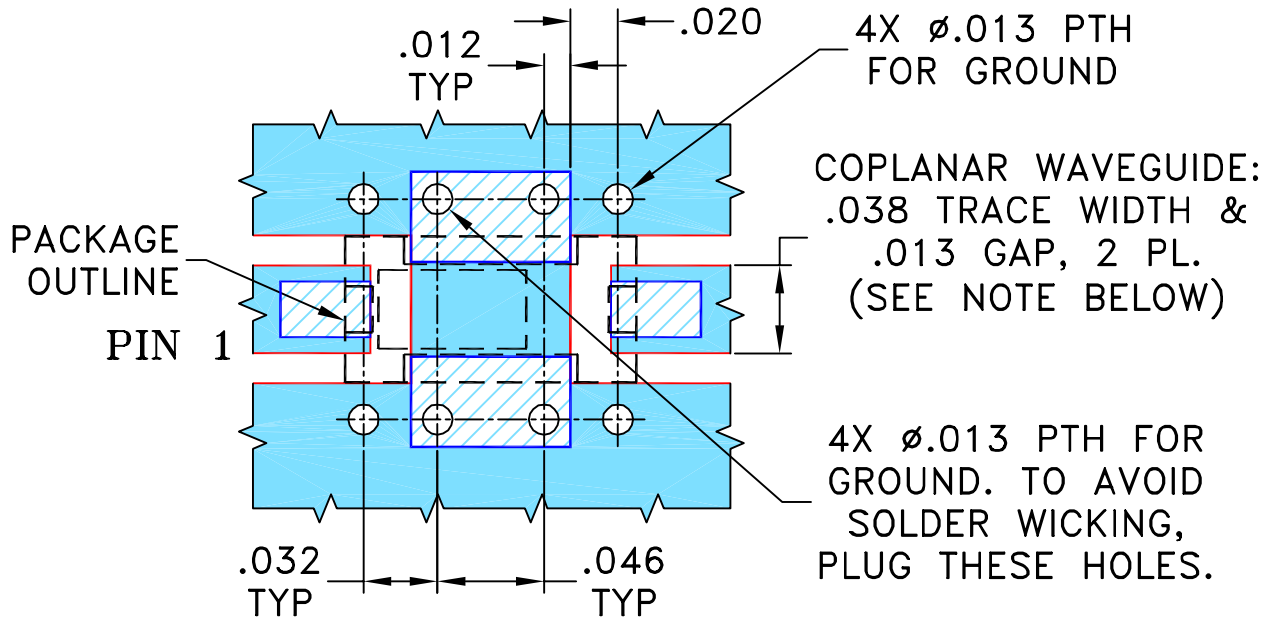

- NOTE:** 1. TRACE WIDTH IS SHOWN FOR ROGERS R04350B WITH DIELECTRIC THICKNESS .020" ± .0015". COPPER: 1/2 OZ. EACH SIDE. FOR OTHER MATERIALS TRACE WIDTH MAY NEED TO BE MODIFIED.
2. BOTTOM SIDE OF THE PCB IS CONTINUOUS GROUND PLANE.



DENOTES PCB COPPER LAYOUT WITH SMOBC (SOLDER MASK OVER BARE COPPER)

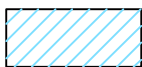

DENOTES COPPER LAND PATTERN FREE OF SOLDER MASK

UNLESS OTHERWISE SPECIFIED

INITIALS

DATE

DIMENSIONS ARE IN INCHES

DRAWN

AV

07/10/09

TOLERANCES ON:

CHECKED

IL

01/15/09

2 PL DECIMALS ±

APPROVED

ABD

01/15/09

3 PL DECIMALS ± .005

ANGLES ±

FRACTIONS ±

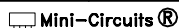

THIS DOCUMENT AND ITS CONTENTS ARE THE PROPERTY OF MINI-CIRCUITS. EXCEPT FOR USE EXPRESSLY GRANTED, IN WRITING, TO ITS VENDORS, VENDEE AND THE UNITED STATES GOVERNMENT, MINI-CIRCUITS RESERVES ALL PROPRIETARY DESIGN, USE, MANUFACTURING AND REPRODUCTION RIGHTS THERETO. THESE CONTENTS SHALL NOT BE USED, DUPLICATED OR DISCLOSED TO ANY OUTSIDE PARTY, IN WHOLE OR IN PART, WITHOUT WRITTEN PERMISSION OF MINI-CIRCUITS.

ASHEETA1.DWG REV:A DATE:01/12/95



**Mini-Circuits®**

13 Neptune Avenue  
Brooklyn NY 11235

PL, 04FL01, FV1206-4, BFCN, TB-518+

SIZE  
A

CODE IDENT  
15542

DRAWING NO:

98-PL-305

REV:

OR

FILE:

98PL305

SCALE:

12:1

SHEET:

1 OF 1

# Evaluation Board and Circuit

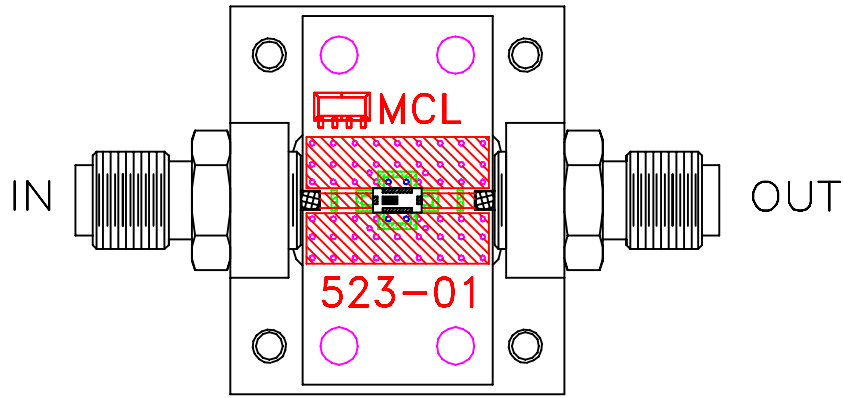

TB-518+

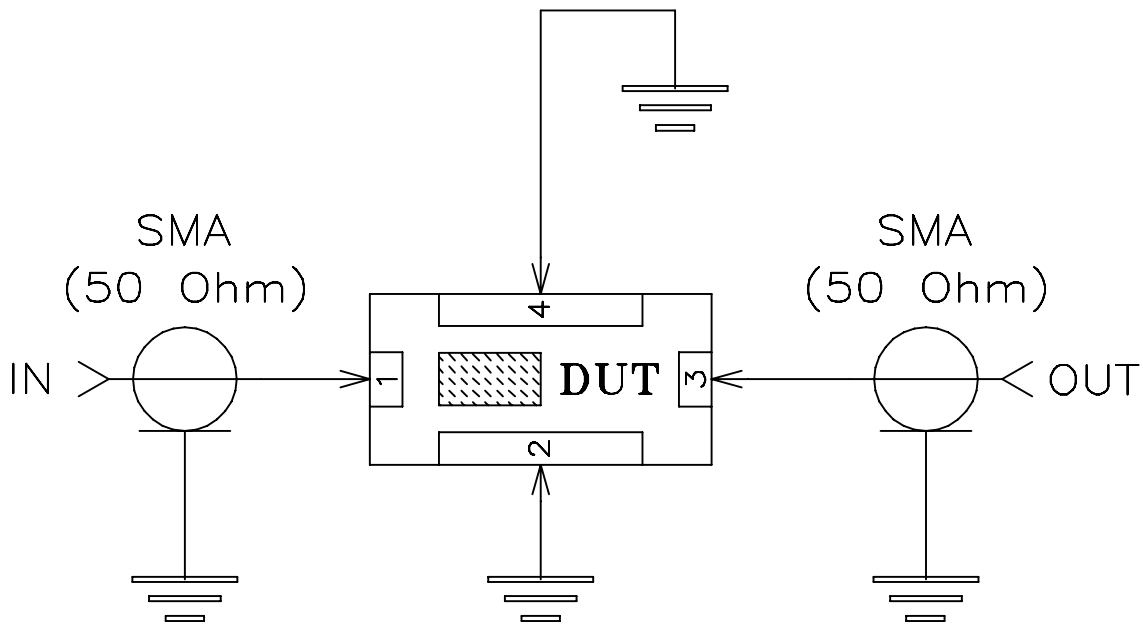

Schematic Diagram

## Notes:

1. 50 Ohm SMA Female connectors.
2. PCB Material: R04350 or equivalent,  
Dielectric Constant=3.5, Thickness=.020 inch.

 Mini-Circuits®





All Mini-Circuits products are manufactured under exacting quality assurance and control standards, and are capable of meeting published specifications after being subjected to any or all of the following physical and environmental test.

Specification	Test/Inspection Condition	Reference/Spec
Operating Temperature	-40° to 85°C	Individual Model Data Sheet
Storage Temperature	-55° to 100° C Ambient Environment	Individual Model Data Sheet
Barometric Pressure	100,000 Feet	MIL-STD-202, Method 105, Condition D
Humidity	90% RH, 65°C Units may require bake-out after humidity to restore full performance.	MIL-STD-202, Method 103
Thermal Shock	-65° to 125°C, 5 cycles	MIL-STD-202, Method 107, Condition B
Vibration (High Frequency)	20g peak, 10-2000 Hz, 12 times in each of three perpendicular directions (total 36)	MIL-STD-202, Method 204, Condition D
Mechanical Shock	100g, 6ms sawtooth, 3 shocks each direction 3 axes (total 18)	MIL-STD-202, Method 213, Condition I