

Ceramic Bandpass Filter

50Ω 4400 to 5200 MHz

BFCN-4800+

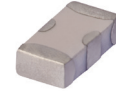

Generic photo used for illustration purposes only

CASE STYLE: FV1206

+RoHS Compliant

The +Suffix identifies RoHS Compliance. See our web site for RoHS Compliance methodologies and qualifications

Available Tape and Reel at no extra cost

Reel Size	Devices/Reel
7"	20, 50, 100, 200, 500, 1000, 3000

Features

- Good VSWR, 1.2:1 typ @ passband
- Small size (0.126 x 0.063 x .037)
- Temperature stable
- LTCC construction

Applications

- Harmonic rejection
- Telemetry
- Satellite
- Mobile
- Military and Commercial

Specification Definition

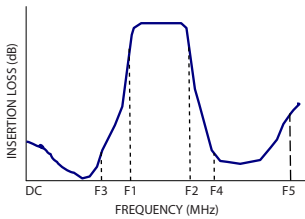

Functional Schematic

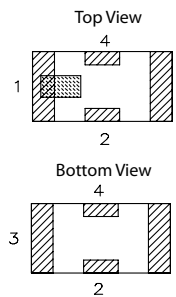
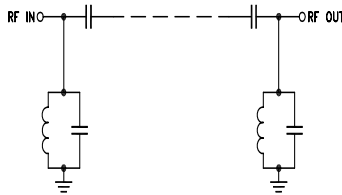

Pad Connections

Input	1
Output	3
Ground	2,4

Electrical Specifications^{1,2} at 25°C

Parameter	F#	Frequency (MHz)	Min.	Typ.	Max.	Unit	
Pass Band	Center Frequency	—	—	4800	—	MHz	
	Insertion Loss	F1 - F2	4400 - 5200	—	—	2.0	dB
	VSWR	F1 - F2	4400 - 5200	—	—	1.7	:1
Stop Band, Lower	Insertion Loss	DC - F3	DC - 1800	—	25	—	dB
	VSWR	DC - F3	DC - 1800	—	30	—	:1
Stop Band, Upper	Insertion Loss	F4 - F5	7500 - 12000	—	25	—	dB
	VSWR	F4 - F5	7500 - 12000	—	15	—	:1

1. Measured on Mini-Circuits Characterization Test Board TB-270.

2. This filter is not intended for use as a DC Blocking circuit element. In Application where DC voltage is present at either input or output ports, blocking capacitors are required at the corresponding RF port.

Maximum Ratings

Operating Temperature	-55°C to 100°C
Storage Temperature	-55°C to +100°C
RF Power Input*	1.5W at 25°C

*Passband rating, derate linearly to 0.25W at 100°C ambient
Permanent damage may occur if any of these limits are exceeded.

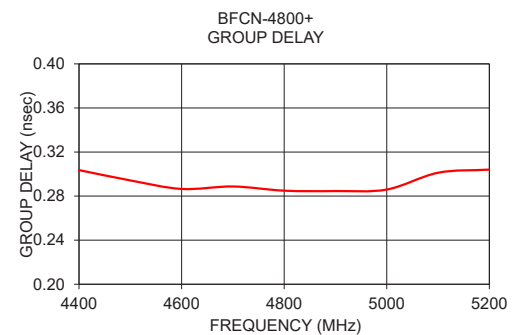
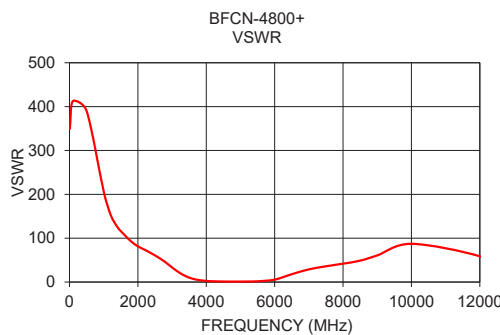
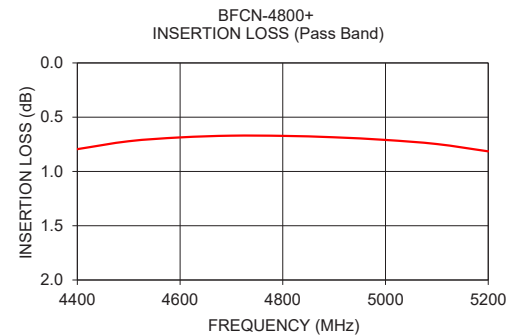
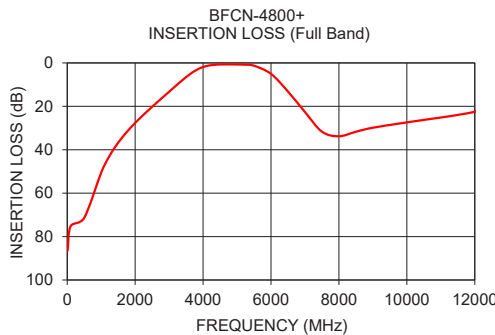

Full Band Performance

Frequency (MHz)	Insertion Loss (dB)	VSWR (:1)
10.00	86.56	349.26
100.00	75.22	412.74
1000.00	50.52	206.71
1800.00	30.99	92.77
4400.00	0.79	1.32
5200.00	0.81	1.23
7500.00	31.68	35.89
10000.00	27.39	87.13
12000.00	22.49	58.68

Pass Band Performance

Frequency (MHz)	Insertion Loss (dB)	Group Delay (nsec)
4400.00	0.79	0.30
4500.00	0.72	0.29
4600.00	0.69	0.29
4700.00	0.67	0.29
4800.00	0.67	0.28
4900.00	0.69	0.28
5000.00	0.71	0.29
5100.00	0.75	0.30
5200.00	0.81	0.30

Pad Connections

Input	1
Output	3
Ground	2,4

Product Marking: BB

Outline Drawing

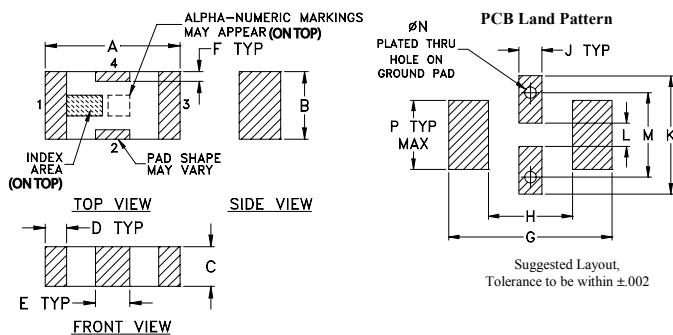

Demo Board MCL P/N: TB-270+ Suggested PCB Layout (PL-137)

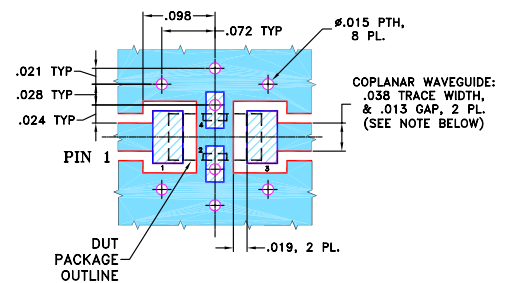

NOTES: 1. COPLANAR WAVEGUIDE PARAMETERS ARE SHOWN FOR ROGERS RO4350B WITH THICKNESS $.020 \pm .0015$, COPPER: 1/2 OZ. EACH SIDE. FOR OTHER MATERIALS TRACE WIDTH & GAP MAY NEED TO BE MODIFIED.

2. BOTTOM SIDE OF THE PCB IS CONTINUOUS GROUND PLANE.
- DENOTES PCB COPPER LAYOUT WITH SMOBC (SOLDER MASK OVER BARE COPPER)
 - DENOTES COPPER LAND PATTERN FREE OF SOLDER MASK

Outline Dimensions (inch/mm)

A	B	C	D	E	F	G	
.126	.063	.037	.020	.032	.009	.169	
3.20	1.60	0.94	0.51	0.81	0.23	4.29	
H	J	K	L	M	N	P	wt
.087	.024	.122	.024	.087	.012	.071	grams
2.21	0.61	3.10	0.61	2.21	0.30	1.80	.020

Additional Notes

- A. Performance and quality attributes and conditions not expressly stated in this specification document are intended to be excluded and do not form a part of this specification document.
- B. Electrical specifications and performance data contained in this specification document are based on Mini-Circuit's applicable established test performance criteria and measurement instructions.
- C. The parts covered by this specification document are subject to Mini-Circuits standard limited warranty and terms and conditions (collectively, "Standard Terms"); Purchasers of this part are entitled to the rights and benefits contained therein. For a full statement of the Standard Terms and the exclusive rights and remedies thereunder, please visit Mini-Circuits' website at www.minicircuits.com/MCLStore/terms.jsp

Ceramic Bandpass Filter

BFCN-4800+

Typical Performance Data

FREQUENCY (MHz)	INSERTION LOSS (dB)	RETURN LOSS (dB)	FREQUENCY (MHz)	GROUP DELAY (ns)
10.0	86.56	0.05	1200.0	0.06
100.0	75.22	0.04	1400.0	0.12
500.0	71.36	0.04	1600.0	0.11
1000.0	50.52	0.08	1800.0	0.12
1200.0	44.06	0.11	2000.0	0.11
1400.0	38.98	0.14	2200.0	0.10
1600.0	34.72	0.16	2400.0	0.12
1800.0	30.99	0.19	2600.0	0.13
2000.0	27.64	0.21	2800.0	0.14
2200.0	24.58	0.24	3000.0	0.16
2400.0	21.64	0.27	3200.0	0.19
2600.0	18.80	0.31	3400.0	0.24
2800.0	16.03	0.38	3600.0	0.29
3000.0	13.27	0.52	3800.0	0.33
3200.0	10.51	0.79	4000.0	0.34
3400.0	7.82	1.30	4200.0	0.32
3600.0	5.33	2.29	4400.0	0.30
3800.0	3.28	4.10	4500.0	0.29
4000.0	1.88	7.05	4600.0	0.29
4200.0	1.12	11.36	4700.0	0.29
4400.0	0.79	17.20	4800.0	0.28
4500.0	0.72	20.96	4900.0	0.28
4600.0	0.69	25.54	5000.0	0.29
4700.0	0.67	31.99	5100.0	0.30
4800.0	0.67	38.94	5200.0	0.30
4900.0	0.69	32.56	5500.0	0.35
5000.0	0.71	27.04	6000.0	0.37
5100.0	0.75	23.07	6500.0	0.26
5200.0	0.81	19.74	7000.0	0.22
5500.0	1.30	11.62	7500.0	0.37
6000.0	5.05	3.20	8000.0	0.35
6500.0	13.19	0.98	8500.0	0.14
7000.0	22.63	0.60	9000.0	0.07
7500.0	31.68	0.48	10000.0	0.10
8000.0	33.79	0.41	12000.0	0.10
8500.0	31.69	0.36		
9000.0	29.84	0.29		
10000.0	27.39	0.20		
12000.0	22.49	0.30		



Typical Performance Curves

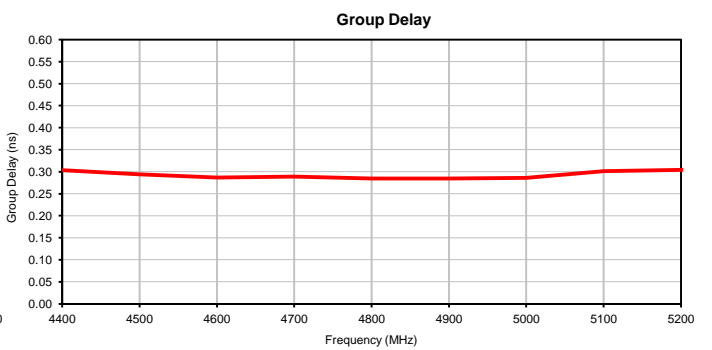
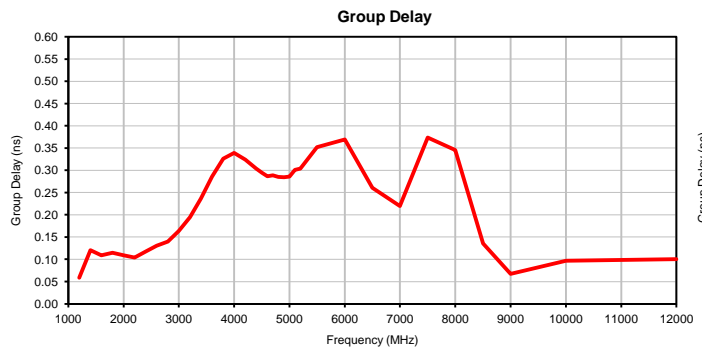
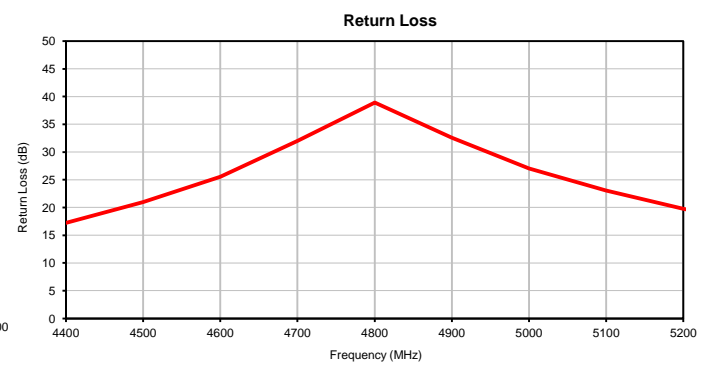
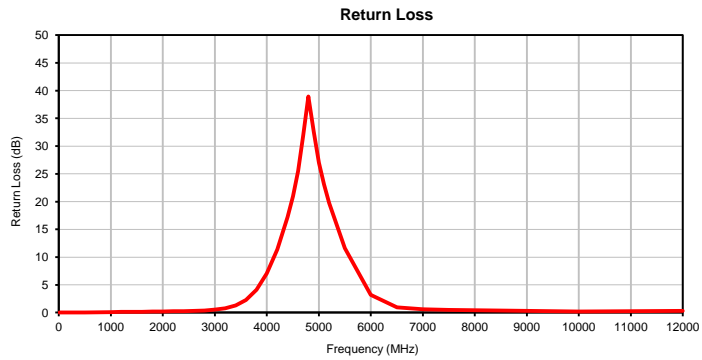
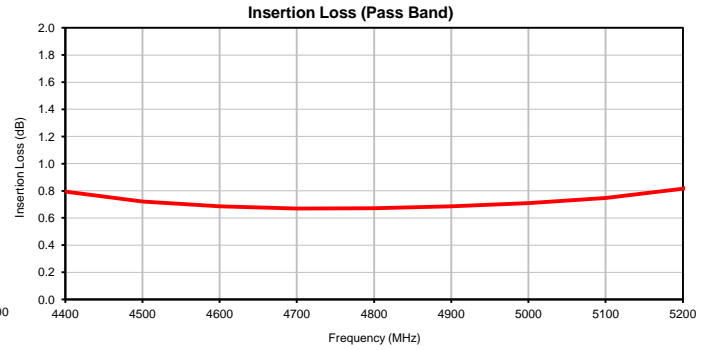
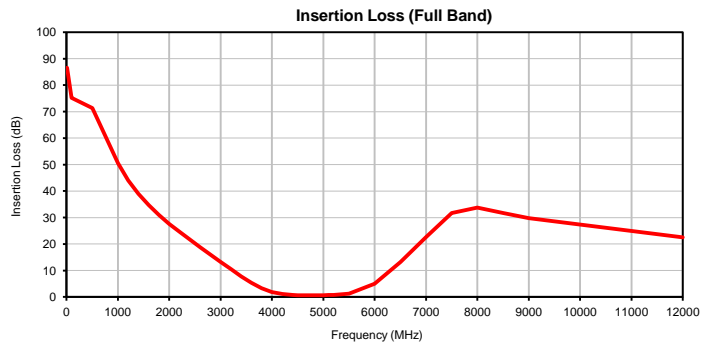

Outline Dimensions

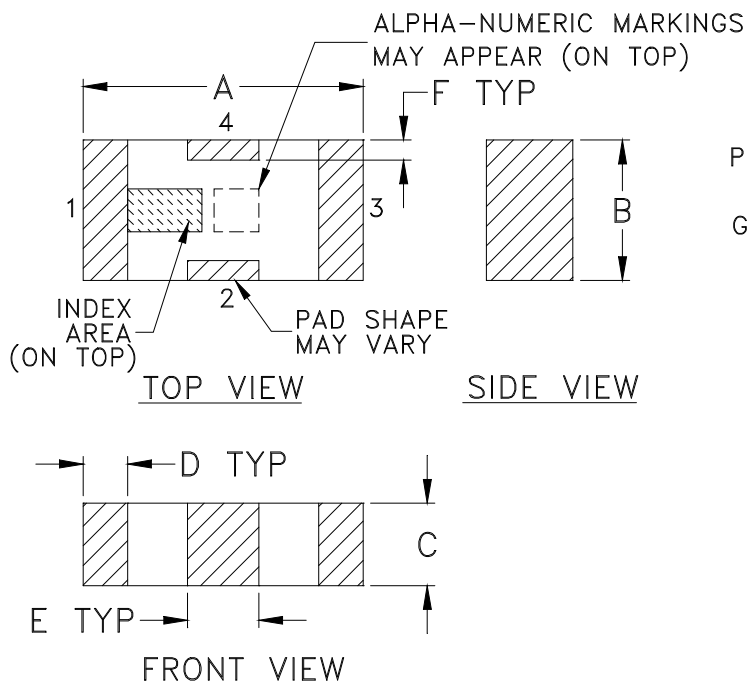

PCB Land Pattern

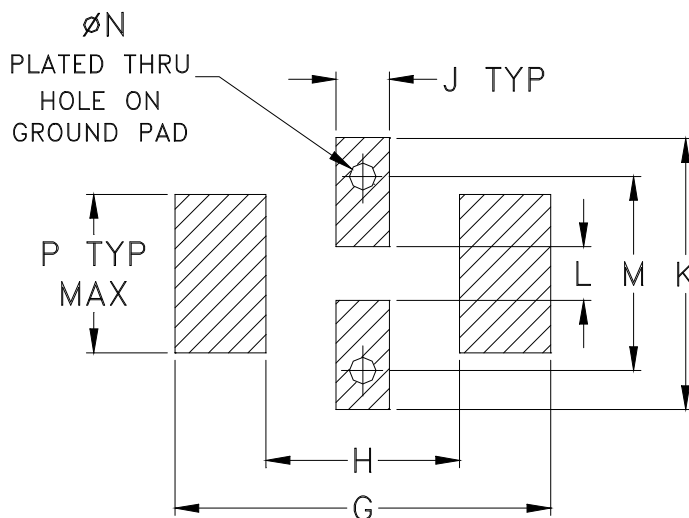

Suggested Layout,
Tolerance to be within $\pm .002$

CASE #	A	B	C	D	E	F	G	H	J	K	L	M	N	P	WT. GRAM
FV1206	.126 (3.20)	.063 (1.60)	.037 (0.94)	.020 (0.51)	.032 (0.81)	.009 (0.23)	.169 (4.29)	.087 (2.21)	.024 (0.61)	.122 (3.10)	.024 (0.61)	.087 (2.21)	.012 (0.30)	.071 (1.80)	.020

Dimensions are in inches (mm). Tolerances: 2 Pl. $\pm .01$; 3 Pl. $\pm .005$

Notes:

- Open style, ceramic base.
- Termination finish: **as shown below or indicated on Data Sheet.**
 For RoHS Case Styles: Tin plate over Nickel plate. All models, (+) suffix.
 For RoHS-5 Case Styles: Tin-Lead plate. All models, no (+) suffix.

Tape & Reel Packaging TR-F71

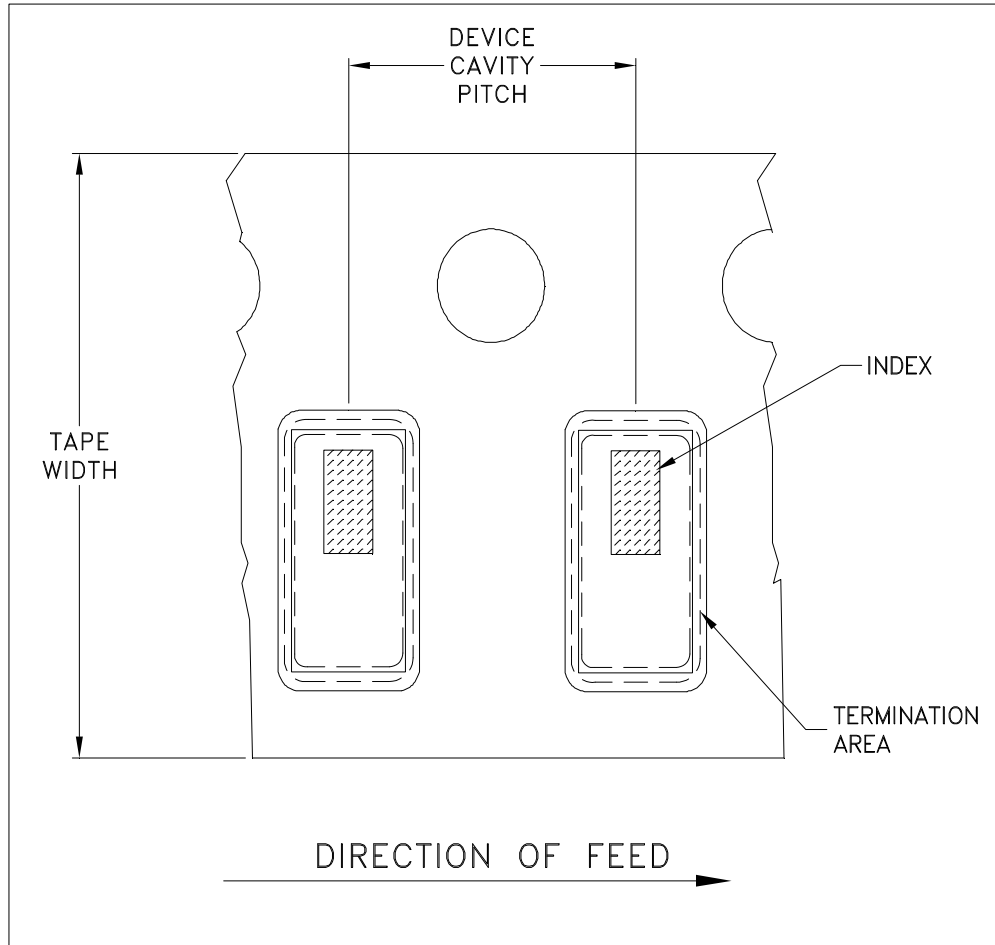

ILLUSTRATION 1

Tape Width, mm	Device Cavity Pitch, mm	Reel Size, inches	Devices per Reel	
8	4	7	Small quantity standards (see note)	20
				50
				100
				200
				500
				1000
			Standard	3000

Note: Please Consult individual model data sheet to determine device per reel availability.

Mini-Circuits carrier tape materials provide protection from ESD (Electro-Static Discharge) during handling and transportation. Tapes are static dissipative and comply with industry standards EIA-481/EIA-541.

Go to: www.minicircuits.com/pages/pdfs/tape.pdf



P.O. Box 350166, Brooklyn, New York 11235-0003 (718) 934-4500 Fax (718) 332-4661 For detailed performance specs & shopping online see Mini-Circuits web site



The Design Engineers Search Engine Provides ACTUAL Data Instantly From MINI-CIRCUITS At: www.minicircuits.com

RF/IF MICROWAVE COMPONENTS

THIRD ANGLE PROJECTION

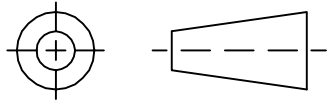

REVISIONS

REV	ECN No.	DESCRIPTION	DATE	DR	AUTH
OR	M88634	NEW RELEASE	08/28/03	GF	ABD
A	M102713	ADDED "...WITH SMOBC"	01/17/06	MMG	IL

SUGGESTED MOUNTING CONFIGURATION
FOR FV1206 CASE STYLE, "nx" PIN CONNECTION

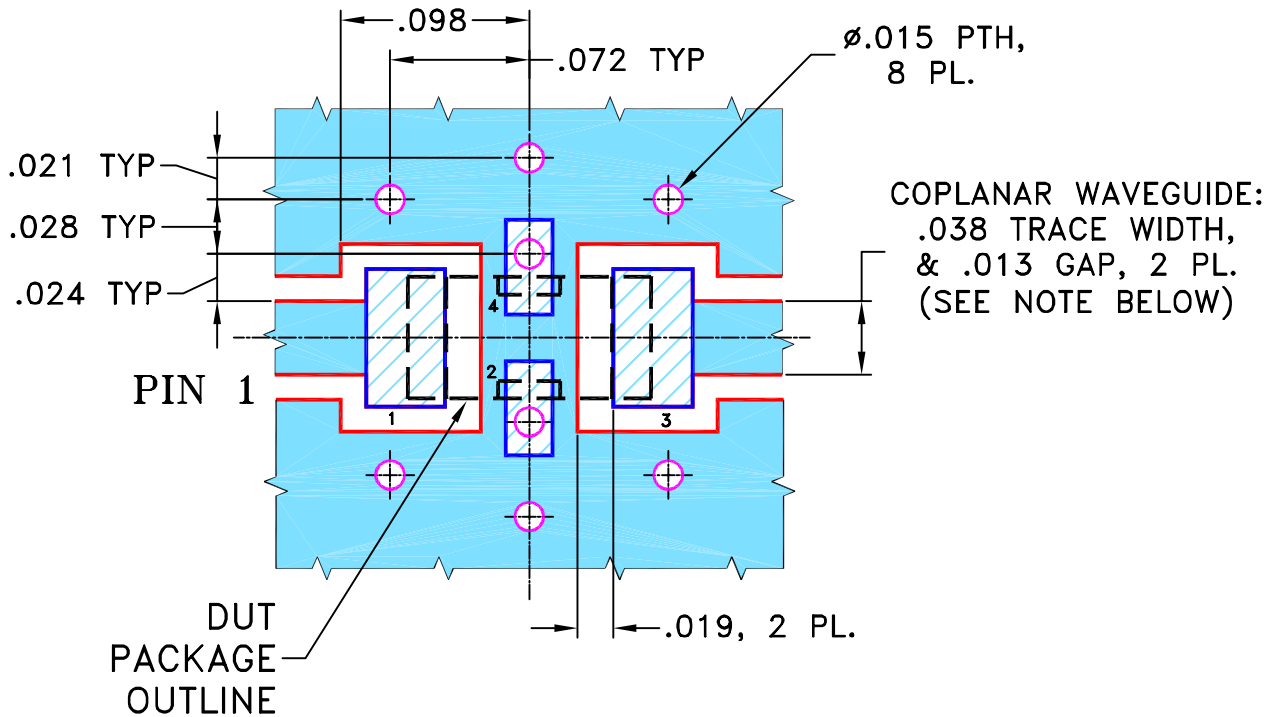

- NOTES:**
- COPLANAR WAVEGUIDE PARAMETERS ARE SHOWN FOR ROGERS R04350B WITH THICKNESS .020" ± .0015".
 COPPER: 1/2 OZ. EACH SIDE.
 FOR OTHER MATERIALS TRACE WIDTH & GAP MAY NEED TO BE MODIFIED.

2. BOTTOM SIDE OF THE PCB IS CONTINUOUS GROUND PLANE.



DENOTES PCB COPPER LAYOUT WITH SMOBC
 (SOLDER MASK OVER BARE COPPER)

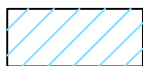

DENOTES COPPER LAND PATTERN FREE OF SOLDER MASK

UNLESS OTHERWISE SPECIFIED	INITIALS	DATE
DIMENSIONS ARE IN INCHES	DRAWN GF	08/27/03
TOLERANCES ON:	CHECKED AV	08/28/03
2 PL DECIMALS ±	APPROVED ABD	08/28/03
3 PL DECIMALS ± .005		
ANGLES ±		
FRACTIONS ±		



Mini-Circuits®

13 Neptune Avenue
 Brooklyn NY 11235

PL, nx, FV1206, LFCN/HFCN, TB-270

SIZE A	CODE IDENT 15542	DRAWING NO: 98-PL-137	REV: A
FILE: 98PL137	SCALE: 10:1	SHEET: 1 OF 1	

Mini-Circuits®
 THIS DOCUMENT AND ITS CONTENTS ARE THE PROPERTY OF MINI-CIRCUITS. EXCEPT FOR USE EXPRESSLY GRANTED, IN WRITING, TO ITS VENDORS, VENDEE AND THE UNITED STATES GOVERNMENT, MINI-CIRCUITS RESERVES ALL PROPRIETARY DESIGN, USE, MANUFACTURING AND REPRODUCTION RIGHTS THERETO. THESE CONTENTS SHALL NOT BE USED, DUPLICATED OR DISCLOSED TO ANY OUTSIDE PARTY, IN WHOLE OR IN PART, WITHOUT WRITTEN PERMISSION OF MINI-CIRCUITS.

Evaluation Board and Circuit

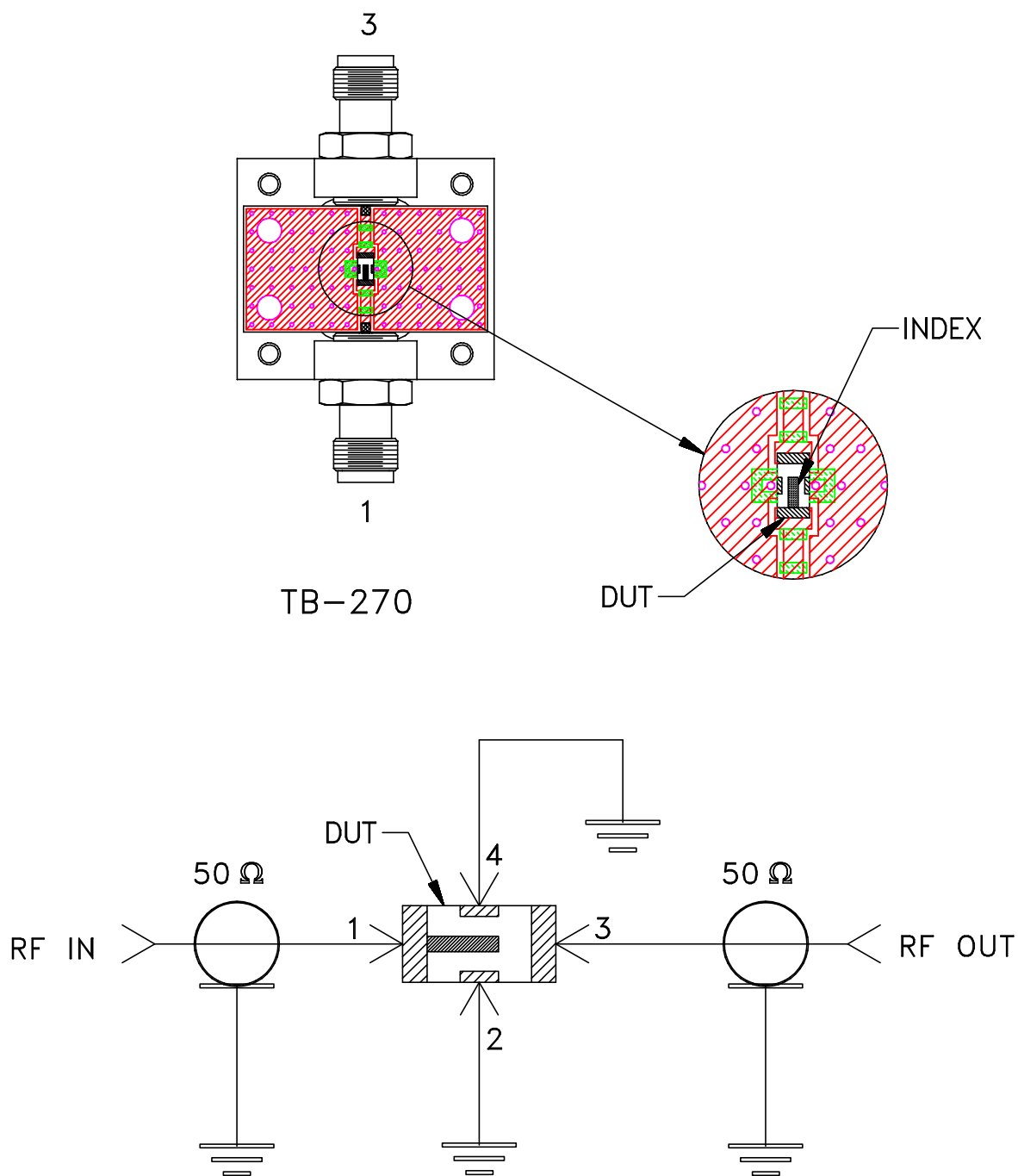

Schematic Diagram

Notes:

1. SMA Female connectors.
2. PCB Material: ROGERS R04350 or equivalent, Dielectric Constant=3.5, Thickness=.020 inch.

 **Mini-Circuits®**

All Mini-Circuits products are manufactured under exacting quality assurance and control standards, and are capable of meeting published specifications after being subjected to any or all of the following physical and environmental test.

Specification	Test/Inspection Condition	Reference/Spec
Operating Temperature	-55° to 100°C Ambient Environment	Individual Model Data Sheet
Storage Temperature	-55° to 100° C Ambient Environment	Individual Model Data Sheet
Humidity	90 to 95% RH, 240 hours, 50°C	MIL-STD-202, Method 103, Condition A, Except 50°C and end-point electrical test done within 12 hours
Solder Reflow Heat	Sn-Pb Eutetic Process: 225°C peak Pb-Free Process 245° - 250°C peak	J-STD-020, Table 4-1, 4-2 and 5-2, Figure 5-1
Solderability	10X Magnification	J-STD-002, Para 4.2.5, Test S, 95% Coverage
Vibration (High Frequency)	20g peak, 10-2000 Hz, 12 times in each of three perpendicular directions (total 36)	MIL-STD-202, Method 204, Condition D
Mechanical Shock	50g, 11 ms, 1/2-sine, 18 shocks: 3 each direction, each of 3 axes	MIL-STD-202, Method 213, Condition A